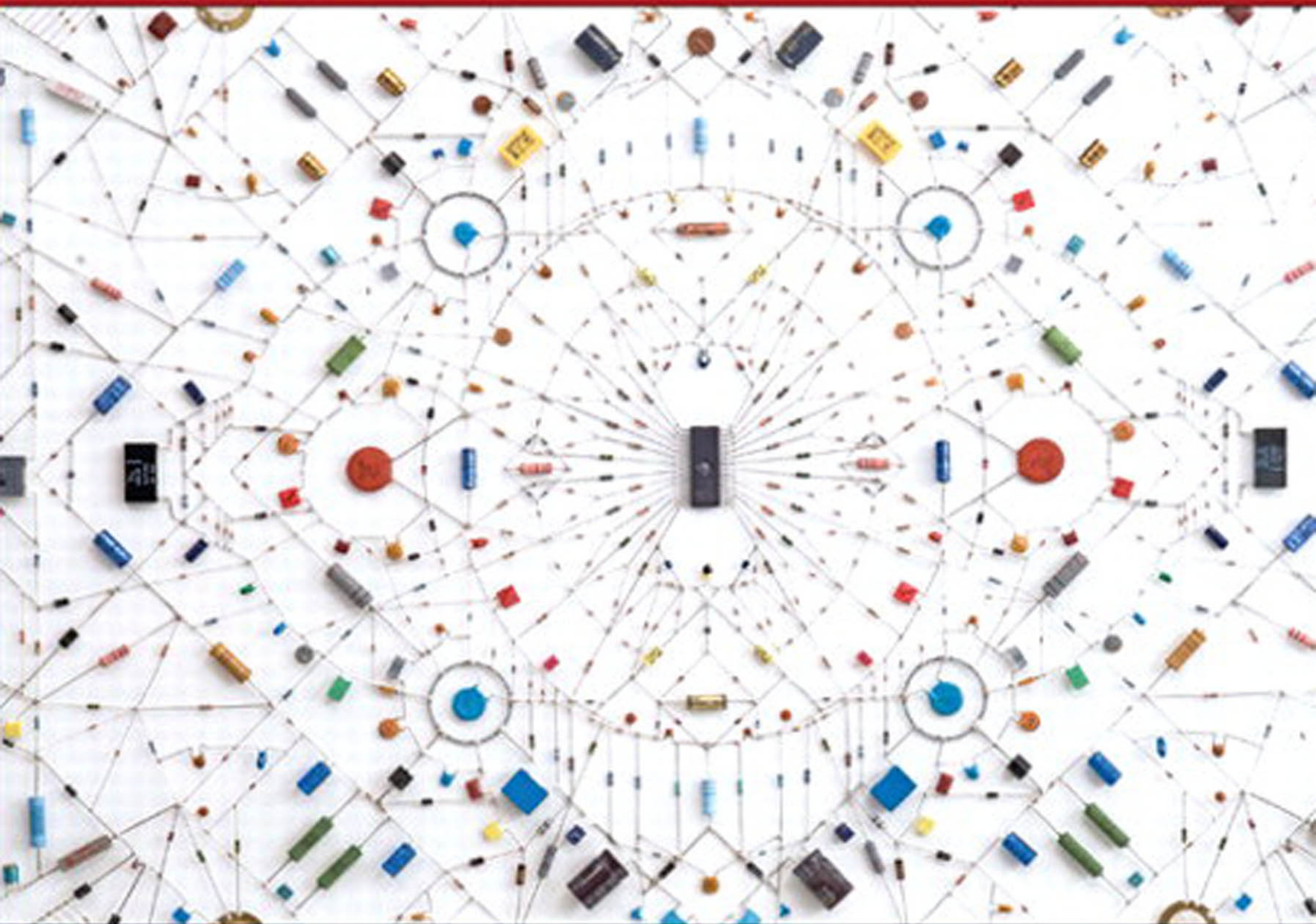


# NILSSON • RIEDEL



## ELECTRIC CIRCUITS

10th Edition

### A List of Tables

Table No.	Title	Page No.
1.1	The International System of Units (SI)	9
1.2	Derived Units in SI	9
1.3	Standardized Prefixes to Signify Powers of 10	9
1.4	Interpretation of Reference Directions in Fig. 1.5	13
4.1	Terms for Describing Circuits	91
4.2	PSpice Sensitivity Analysis Results	128
6.1	Terminal Equations for Ideal Inductors and Capacitors	203
6.2	Equations for Series- and Parallel-Connected Inductors and Capacitors	203
7.1	Value of $e^{-t/\tau}$ for $t$ Equal to Integral Multiples of $\tau$	217
8.1	Natural Response Parameters of the Parallel $RLC$ Circuit	269
8.2	The Response of a Second-Order Circuit is Overdamped, Underdamped, or Critically Damped	295
8.3	In Determining the Natural Response of a Second-Order Circuit, We First Determine Whether it is Over-, Under-, or Critically Damped, and Then We Solve the Appropriate Equations	295
8.4	In Determining the Step Response of a Second-Order Circuit, We Apply the Appropriate Equations Depending on the Damping	296
9.1	Impedance and Reactance Values	318
9.2	Admittance and Susceptance Values	322
9.3	Impedance and Related Values	345
10.1	Annual Energy Requirements of Electric Household Appliances	365
10.2	Three Power Quantities and Their Units	368
12.1	An Abbreviated List of Laplace Transform Pairs	435
12.2	An Abbreviated List of Operational Transforms	440
12.3	Four Useful Transform Pairs	451
13.1	Summary of the $s$ -Domain Equivalent Circuits	468
13.2	Numerical Values of $v_o(t)$	492
14.1	Input and Output Voltage Magnitudes for Several Frequencies	527
15.1	Normalized (so that $\omega_c = 1$ rad/s) Butterworth Polynomials up to the Eighth Order	577
17.1	Fourier Transforms of Elementary Functions	653
17.2	Operational Transforms	658
18.1	Parameter Conversion Table	682
18.2	Terminated Two-Port Equations	688

### Greek Alphabet

A	$\alpha$	Alpha	I	$\iota$	Iota	P	$\rho$	Rho
B	$\beta$	Beta	K	$\kappa$	Kappa	$\Sigma$	$\sigma$	Sigma
$\Gamma$	$\gamma$	Gamma	$\Lambda$	$\lambda$	Lambda	T	$\tau$	Tau
$\Delta$	$\delta$	Delta	M	$\mu$	Mu	$\Upsilon$	$\upsilon$	Upsilon
E	$\epsilon$	Epsilon	N	$\nu$	Nu	$\Phi$	$\phi$	Phi
Z	$\zeta$	Zeta	$\Xi$	$\xi$	Xi	X	$\chi$	Chi
H	$\eta$	Eta	O	$o$	Omicron	$\Psi$	$\psi$	Psi
$\Theta$	$\theta$	Theta	$\Pi$	$\pi$	Pi	$\Omega$	$\omega$	Omega

# ELECTRIC CIRCUITS

TENTH EDITION

*This page intentionally left blank*



# ELECTRIC CIRCUITS

## TENTH EDITION

James W. Nilsson

*Professor Emeritus  
Iowa State University*

Susan A. Riedel

*Marquette University*

**PEARSON**

Boston Columbus Indianapolis New York San Francisco Upper Saddle River  
Amsterdam Cape Town Dubai London Madrid Milan Munich Paris Montréal Toronto  
Delhi Mexico City São Paulo Sydney Hong Kong Seoul Singapore Taipei Tokyo

*Vice President and Editorial Director:*  
Marcia J. Horton  
*Executive Editor:* Andrew Gilfillan  
*Editorial Assistant:* Sandra Rodriguez  
*Marketing Manager:* Tim Galligan  
*Senior Managing Editor:* Scott Disanno  
*Production Editor:* Rose Kernan

*Cover Design:* Black Horse Designs  
*Cover Art:* Inverter 04 Oil painting by Ben Leone  
“TechScape” Collection. [www.benleone.com](http://www.benleone.com)  
*Manager, Cover Visual Research & Permissions:*  
Karen Sanatar  
*Photo Researcher:* Marta Samsel  
*Composition:* Integra Publishing Services

Credits and acknowledgments borrowed from other sources and reproduced, with permission, in this textbook appear on appropriate page within text.

---

**Copyright © 2015, 2008, 2005 Pearson Education, Inc., publishing as Prentice Hall, One Lake Street, Upper Saddle River, New Jersey, 07458.** All rights reserved. Manufactured in the United States of America. This publication is protected by Copyright, and permission should be obtained from the publisher prior to any prohibited reproduction, storage in a retrieval system, or transmission in any form or by any means, electronic, mechanical, photocopying, recording, or likewise. To obtain permission(s) to use material from this work, please submit a written request to Pearson Education, Inc., Permissions Department, One Lake Street, Upper Saddle River, New Jersey, 07458.

**Library of Congress Cataloging-in-Publication Data**

Nilsson, James William.

Electric circuits / James W. Nilsson, Professor Emeritus, Iowa State University, Susan A. Riedel, Marquette University. — Tenth edition.

pages cm

ISBN-13: 978-0-13-376003-3

ISBN-10: 0-13-376003-0

1. Electric circuits. I. Riedel, Susan A. II. Title.

TK545.N54 2015

621.319'2—dc23

2013037725

10 9 8 7 6 5 4 3 2

**PEARSON**

ISBN-13: 978-0-13-376003-3  
ISBN-10: 0-13-376003-0

To Anna

*This page intentionally left blank*



# Brief Contents

	List of Examples	xiii
	Preface	xvii
<b>Chapter 1</b>	Circuit Variables	2
<b>Chapter 2</b>	Circuit Elements	24
<b>Chapter 3</b>	Simple Resistive Circuits	56
<b>Chapter 4</b>	Techniques of Circuit Analysis	88
<b>Chapter 5</b>	The Operational Amplifier	144
<b>Chapter 6</b>	Inductance, Capacitance, and Mutual Inductance	174
<b>Chapter 7</b>	Response of First-Order $RL$ and $RC$ Circuits	212
<b>Chapter 8</b>	Natural and Step Responses of $RLC$ Circuits	264
<b>Chapter 9</b>	Sinusoidal Steady-State Analysis	304
<b>Chapter 10</b>	Sinusoidal Steady-State Power Calculations	358
<b>Chapter 11</b>	Balanced Three-Phase Circuits	396
<b>Chapter 12</b>	Introduction to the Laplace Transform	426
<b>Chapter 13</b>	The Laplace Transform in Circuit Analysis	464
<b>Chapter 14</b>	Introduction to Frequency Selective Circuits	520
<b>Chapter 15</b>	Active Filter Circuits	556
<b>Chapter 16</b>	Fourier Series	602
<b>Chapter 17</b>	The Fourier Transform	642
<b>Chapter 18</b>	Two-Port Circuits	676
<b>Appendix A</b>	The Solution of Linear Simultaneous Equations	703
<b>Appendix B</b>	Complex Numbers	723
<b>Appendix C</b>	More on Magnetically Coupled Coils and Ideal Transformers	729
<b>Appendix D</b>	The Decibel	737
<b>Appendix E</b>	Bode Diagrams	739
<b>Appendix F</b>	An Abbreviated Table of Trigonometric Identities	757
<b>Appendix G</b>	An Abbreviated Table of Integrals	759
<b>Appendix H</b>	Common Standard Component Values	761
	Answers to Selected Problems	763
	Index	775



*This page intentionally left blank*



# Contents

List of Examples xiii

Preface xvii

## Chapter 1 Circuit Variables 2

*Practical Perspective: Balancing Power* 3

1.1 Electrical Engineering: An Overview 4

1.2 The International System of Units 8

1.3 Circuit Analysis: An Overview 10

1.4 Voltage and Current 11

1.5 The Ideal Basic Circuit Element 12

1.6 Power and Energy 14

*Practical Perspective: Balancing Power* 17

*Summary* 18

*Problems* 19

## Chapter 2 Circuit Elements 24

*Practical Perspective: Heating with Electric Radiators* 25

2.1 Voltage and Current Sources 26

2.2 Electrical Resistance (Ohm's Law) 30

2.3 Construction of a Circuit Model 34

2.4 Kirchhoff's Laws 37

2.5 Analysis of a Circuit Containing Dependent Sources 42

*Practical Perspective: Heating with Electric Radiators* 46

*Summary* 48

*Problems* 48

## Chapter 3 Simple Resistive Circuits 56

*Practical Perspective: Resistive Touch Screens* 57

3.1 Resistors in Series 58

3.2 Resistors in Parallel 59

3.3 The Voltage-Divider and Current-Divider Circuits 61

3.4 Voltage Division and Current Division 64

3.5 Measuring Voltage and Current 66

3.6 Measuring Resistance—The Wheatstone Bridge 69

3.7 Delta-to-Wye (Pi-to-Tee) Equivalent Circuits 71

*Practical Perspective: Resistive Touch Screens* 73

*Summary* 75

*Problems* 76

## Chapter 4 Techniques of Circuit Analysis 88

*Practical Perspective: Circuits with Realistic Resistors* 89

4.1 Terminology 90

4.2 Introduction to the Node-Voltage Method 93

4.3 The Node-Voltage Method and Dependent Sources 95

4.4 The Node-Voltage Method: Some Special Cases 96

4.5 Introduction to the Mesh-Current Method 99

4.6 The Mesh-Current Method and Dependent Sources 102

4.7 The Mesh-Current Method: Some Special Cases 103

4.8 The Node-Voltage Method Versus the Mesh-Current Method 106

4.9 Source Transformations 109

4.10 Thévenin and Norton Equivalents 113

4.11 More on Deriving a Thévenin Equivalent 117

4.12 Maximum Power Transfer 120

4.13 Superposition 122

*Practical Perspective: Circuits with Realistic Resistors* 125

*Summary* 129

*Problems* 130

## Chapter 5 The Operational Amplifier 144

*Practical Perspective: Strain Gages* 145

5.1 Operational Amplifier Terminals 146

5.2 Terminal Voltages and Currents 146

5.3 The Inverting-Amplifier Circuit 150

5.4 The Summing-Amplifier Circuit 152

5.5 The Noninverting-Amplifier Circuit 153

5.6 The Difference-Amplifier Circuit 155

5.7 A More Realistic Model for the Operational Amplifier 159

*Practical Perspective: Strain Gages* 162

*Summary* 164

*Problems* 165

**Chapter 6 Inductance, Capacitance, and Mutual Inductance 174**

*Practical Perspective: Capacitive Touch Screens 175*

- 6.1 The Inductor 176
- 6.2 The Capacitor 182
- 6.3 Series-Parallel Combinations of Inductance and Capacitance 187
- 6.4 Mutual Inductance 189
- 6.5 A Closer Look at Mutual Inductance 193  
*Practical Perspective: Capacitive Touch Screens 200*  
*Summary 202*  
*Problems 204*

**Chapter 7 Response of First-Order RL and RC Circuits 212**

*Practical Perspective: Artificial Pacemaker 213*

- 7.1 The Natural Response of an RL Circuit 214
- 7.2 The Natural Response of an RC Circuit 220
- 7.3 The Step Response of RL and RC Circuits 224
- 7.4 A General Solution for Step and Natural Responses 231
- 7.5 Sequential Switching 236
- 7.6 Unbounded Response 240
- 7.7 The Integrating Amplifier 241  
*Practical Perspective: Artificial Pacemaker 245*  
*Summary 246*  
*Problems 247*

**Chapter 8 Natural and Step Responses of RLC Circuits 264**

*Practical Perspective: Clock for Computer Timing 265*

- 8.1 Introduction to the Natural Response of a Parallel RLC Circuit 266
- 8.2 The Forms of the Natural Response of a Parallel RLC Circuit 270
- 8.3 The Step Response of a Parallel RLC Circuit 280
- 8.4 The Natural and Step Response of a Series RLC Circuit 285
- 8.5 A Circuit with Two Integrating Amplifiers 289  
*Practical Perspective: Clock for Computer Timing 293*  
*Summary 295*  
*Problems 296*

**Chapter 9 Sinusoidal Steady-State Analysis 304**

*Practical Perspective: A Household Distribution Circuit 305*

- 9.1 The Sinusoidal Source 306
- 9.2 The Sinusoidal Response 309
- 9.3 The Phasor 310
- 9.4 The Passive Circuit Elements in the Frequency Domain 315
- 9.5 Kirchhoff's Laws in the Frequency Domain 319
- 9.6 Series, Parallel, and Delta-to-Wye Simplifications 320
- 9.7 Source Transformations and Thévenin-Norton Equivalent Circuits 327
- 9.8 The Node-Voltage Method 330
- 9.9 The Mesh-Current Method 331
- 9.10 The Transformer 332
- 9.11 The Ideal Transformer 336
- 9.12 Phasor Diagrams 342  
*Practical Perspective: A Household Distribution Circuit 344*  
*Summary 345*  
*Problems 346*

**Chapter 10 Sinusoidal Steady-State Power Calculations 358**

*Practical Perspective: Vampire Power 359*

- 10.1 Instantaneous Power 360
- 10.2 Average and Reactive Power 361
- 10.3 The rms Value and Power Calculations 366
- 10.4 Complex Power 368
- 10.5 Power Calculations 369
- 10.6 Maximum Power Transfer 376  
*Practical Perspective: Vampire Power 382*  
*Summary 384*  
*Problems 385*

**Chapter 11 Balanced Three-Phase Circuits 396**

*Practical Perspective: Transmission and Distribution of Electric Power 397*

- 11.1 Balanced Three-Phase Voltages 398
- 11.2 Three-Phase Voltage Sources 399
- 11.3 Analysis of the Wye-Wye Circuit 400
- 11.4 Analysis of the Wye-Delta Circuit 405
- 11.5 Power Calculations in Balanced Three-Phase Circuits 408
- 11.6 Measuring Average Power in Three-Phase Circuits 413  
*Practical Perspective: Transmission and Distribution of Electric Power 416*  
*Summary 417*  
*Problems 418*

## Chapter 12 Introduction to the Laplace Transform 426

- Practical Perspective: Transient Effects* 427
- 12.1 Definition of the Laplace Transform 428
- 12.2 The Step Function 429
- 12.3 The Impulse Function 431
- 12.4 Functional Transforms 434
- 12.5 Operational Transforms 435
- 12.6 Applying the Laplace Transform 440
- 12.7 Inverse Transforms 442
- 12.8 Poles and Zeros of  $F(s)$  452
- 12.9 Initial- and Final-Value Theorems 453
- Practical Perspective: Transient Effects* 456
- Summary* 457
- Problems* 458

## Chapter 13 The Laplace Transform in Circuit Analysis 464

- Practical Perspective: Surge Suppressors* 465
- 13.1 Circuit Elements in the  $s$  Domain 466
- 13.2 Circuit Analysis in the  $s$  Domain 468
- 13.3 Applications 470
- 13.4 The Transfer Function 482
- 13.5 The Transfer Function in Partial Fraction Expansions 484
- 13.6 The Transfer Function and the Convolution Integral 487
- 13.7 The Transfer Function and the Steady-State Sinusoidal Response 493
- 13.8 The Impulse Function in Circuit Analysis 496
- Practical Perspective: Surge Suppressors* 503
- Summary* 504
- Problems* 505

## Chapter 14 Introduction to Frequency Selective Circuits 520

- Practical Perspective: Pushbutton Telephone Circuits* 521
- 14.1 Some Preliminaries 522
- 14.2 Low-Pass Filters 524
- 14.3 High-Pass Filters 530
- 14.4 Bandpass Filters 534
- 14.5 Bandreject Filters 543
- Practical Perspective: Pushbutton Telephone Circuits* 548
- Summary* 548
- Problems* 549

## Chapter 15 Active Filter Circuits 556

- Practical Perspective: Bass Volume Control* 557
- 15.1 First-Order Low-Pass and High-Pass Filters 558
- 15.2 Scaling 562
- 15.3 Op Amp Bandpass and Bandreject Filters 564
- 15.4 Higher Order Op Amp Filters 571
- 15.5 Narrowband Bandpass and Bandreject Filters 584
- Practical Perspective: Bass Volume Control* 589
- Summary* 592
- Problems* 593

## Chapter 16 Fourier Series 602

- Practical Perspective: Active High-Q Filters* 603
- 16.1 Fourier Series Analysis: An Overview 605
- 16.2 The Fourier Coefficients 606
- 16.3 The Effect of Symmetry on the Fourier Coefficients 609
- 16.4 An Alternative Trigonometric Form of the Fourier Series 615
- 16.5 An Application 617
- 16.6 Average-Power Calculations with Periodic Functions 621
- 16.7 The rms Value of a Periodic Function 624
- 16.8 The Exponential Form of the Fourier Series 625
- 16.9 Amplitude and Phase Spectra 628
- Practical Perspective: Active High-Q Filters* 630
- Summary* 632
- Problems* 633

## Chapter 17 The Fourier Transform 642

- Practical Perspective: Filtering Digital Signals* 643
- 17.1 The Derivation of the Fourier Transform 644
- 17.2 The Convergence of the Fourier Integral 646
- 17.3 Using Laplace Transforms to Find Fourier Transforms 648
- 17.4 Fourier Transforms in the Limit 651
- 17.5 Some Mathematical Properties 653
- 17.6 Operational Transforms 655
- 17.7 Circuit Applications 659
- 17.8 Parseval's Theorem 662
- Practical Perspective: Filtering Digital Signals* 669
- Summary* 670
- Problems* 670

**Chapter 18 Two-Port Circuits 676**

*Practical Perspective: Characterizing an Unknown Circuit* 677

- 18.1 The Terminal Equations 678
- 18.2 The Two-Port Parameters 679
- 18.3 Analysis of the Terminated Two-Port Circuit 687
- 18.4 Interconnected Two-Port Circuits 692  
*Practical Perspective: Characterizing an Unknown Circuit* 695  
*Summary* 696  
*Problems* 696

**Appendix A The Solution of Linear Simultaneous Equations 703**

- A.1 Preliminary Steps 703
- A.2 Cramer's Method 704
- A.3 The Characteristic Determinant 704
- A.4 The Numerator Determinant 704
- A.5 The Evaluation of a Determinant 705
- A.6 Matrices 707
- A.7 Matrix Algebra 708
- A.8 Identity, Adjoint, and Inverse Matrices 712
- A.9 Partitioned Matrices 715
- A.10 Applications 718

**Appendix B Complex Numbers 723**

- B.1 Notation 723
- B.2 The Graphical Representation of a Complex Number 724
- B.3 Arithmetic Operations 725
- B.4 Useful Identities 726
- B.5 The Integer Power of a Complex Number 727
- B.6 The Roots of a Complex Number 727

**Appendix C More on Magnetically Coupled Coils and Ideal Transformers 729**

- C.1 Equivalent Circuits for Magnetically Coupled Coils 729
- C.2 The Need for Ideal Transformers in the Equivalent Circuits 733

**Appendix D The Decibel 737**

**Appendix E Bode Diagrams 739**

- E.1 Real, First-Order Poles and Zeros 739
- E.2 Straight-Line Amplitude Plots 740
- E.3 More Accurate Amplitude Plots 744
- E.4 Straight-Line Phase Angle Plots 745
- E.5 Bode Diagrams: Complex Poles and Zeros 747
- E.6 Amplitude Plots 749
- E.7 Correcting Straight-Line Amplitude Plots 750
- E.8 Phase Angle Plots 753

**Appendix F An Abbreviated Table of Trigonometric Identities 757**

**Appendix G An Abbreviated Table of Integrals 759**

**Appendix H Common Standard Component Values 761**

**Answers to Selected Problems 763**

**Index 775**





# List of Examples

## Chapter 1

- 1.1 Using SI Units and Prefixes for Powers of 10 10
- 1.2 Relating Current and Charge 14
- 1.3 Relating Voltage, Current, Power, and Energy 16

## Chapter 2

- 2.1 Testing Interconnections of Ideal Sources 28
- 2.2 Testing Interconnections of Ideal Independent and Dependent Sources 29
- 2.3 Calculating Voltage, Current, and Power for a Simple Resistive Circuit 33
- 2.4 Constructing a Circuit Model of a Flashlight 34
- 2.5 Constructing a Circuit Model Based on Terminal Measurements 36
- 2.6 Using Kirchhoff's Current Law 39
- 2.7 Using Kirchhoff's Voltage Law 40
- 2.8 Applying Ohm's Law and Kirchhoff's Laws to Find an Unknown Current 40
- 2.9 Constructing a Circuit Model Based on Terminal Measurements 41
- 2.10 Applying Ohm's Law and Kirchhoff's Laws to Find an Unknown Voltage 44
- 2.11 Applying Ohm's Law and Kirchhoff's Law in an Amplifier Circuit 45

## Chapter 3

- 3.1 Applying Series-Parallel Simplification 60
- 3.2 Analyzing the Voltage-Divider Circuit 62
- 3.3 Analyzing a Current-Divider Circuit 63
- 3.4 Using Voltage Division and Current Division to Solve a Circuit 66
- 3.5 Using a d'Arsonval Ammeter 68
- 3.6 Using a d'Arsonval Voltmeter 68
- 3.7 Applying a Delta-to-Wye Transform 72

## Chapter 4

- 4.1 Identifying Node, Branch, Mesh and Loop in a Circuit 90
- 4.2 Using the Node-Voltage Method 94
- 4.3 Using the Node-Voltage Method with Dependent Sources 95
- 4.4 Using the Mesh-Current Method 101
- 4.5 Using the Mesh-Current Method with Dependent Sources 102

- 4.6 Understanding the Node-Voltage Method Versus Mesh-Current Method 107
- 4.7 Comparing the Node-Voltage and Mesh-Current Methods 108
- 4.8 Using Source Transformations to Solve a Circuit 110
- 4.9 Using Special Source Transformation Techniques 112
- 4.10 Finding the Thévenin Equivalent of a Circuit with a Dependent Source 116
- 4.11 Finding the Thévenin Equivalent Using a Test Source 118
- 4.12 Calculating the Condition for Maximum Power Transfer 121
- 4.13 Using Superposition to Solve a Circuit 124

## Chapter 5

- 5.1 Analyzing an Op Amp Circuit 149
- 5.2 Designing an Inverting Amplifier 151
- 5.3 Designing a Noninverting Amplifier 154
- 5.4 Designing a Difference Amplifier 155

## Chapter 6

- 6.1 Determining the Voltage, Given the Current, at the Terminals of an Inductor 177
- 6.2 Determining the Current, Given the Voltage, at the Terminals of an Inductor 178
- 6.3 Determining the Current, Voltage, Power, and Energy for an Inductor 180
- 6.4 Determining Current, Voltage, Power, and Energy for a Capacitor 184
- 6.5 Finding  $v$ ,  $p$ , and  $w$  Induced by a Triangular Current Pulse for a Capacitor 185
- 6.6 Finding Mesh-Current Equations for a Circuit with Magnetically Coupled Coils 192

## Chapter 7

- 7.1 Determining the Natural Response of an  $RL$  Circuit 218
- 7.2 Determining the Natural Response of an  $RL$  Circuit with Parallel Inductors 219
- 7.3 Determining the Natural Response of an  $RC$  Circuit 222
- 7.4 Determining the Natural Response of an  $RC$  Circuit with Series Capacitors 223

- 7.5 Determining the Step Response of an *RL* Circuit 227
- 7.6 Determining the Step Response of an *RC* Circuit 230
- 7.7 Using the General Solution Method to Find an *RC* Circuit's Step Response 233
- 7.8 Using the General Solution Method with Zero Initial Conditions 234
- 7.9 Using the General Solution Method to Find an *RL* Circuit's Step Response 234
- 7.10 Determining the Step Response of a Circuit with Magnetically Coupled Coils 235
- 7.11 Analyzing an *RL* Circuit that has Sequential Switching 237
- 7.12 Analyzing an *RC* Circuit that has Sequential Switching 239
- 7.13 Finding the Unbounded Response in an *RC* Circuit 241
- 7.14 Analyzing an Integrating Amplifier 243
- 7.15 Analyzing an Integrating Amplifier that has Sequential Switching 243

## Chapter 8

- 8.1 Finding the Roots of the Characteristic Equation of a Parallel *RLC* Circuit 269
- 8.2 Finding the Overdamped Natural Response of a Parallel *RLC* Circuit 272
- 8.3 Calculating Branch Currents in the Natural Response of a Parallel *RLC* Circuit 273
- 8.4 Finding the Underdamped Natural Response of a Parallel *RLC* Circuit 275
- 8.5 Finding the Critically Damped Natural Response of a Parallel *RLC* Circuit 278
- 8.6 Finding the Overdamped Step Response of a Parallel *RLC* Circuit 282
- 8.7 Finding the Underdamped Step Response of a Parallel *RLC* Circuit 283
- 8.8 Finding the Critically Damped Step Response of a Parallel *RLC* Circuit 283
- 8.9 Comparing the Three-Step Response Forms 284
- 8.10 Finding Step Response of a Parallel *RLC* Circuit with Initial Stored Energy 284
- 8.11 Finding the Underdamped Natural Response of a Series *RLC* Circuit 287
- 8.12 Finding the Underdamped Step Response of a Series *RLC* Circuit 288
- 8.13 Analyzing Two Cascaded Integrating Amplifiers 290
- 8.14 Analyzing Two Cascaded Integrating Amplifiers with Feedback Resistors 293

## Chapter 9

- 9.1 Finding the Characteristics of a Sinusoidal Current 307
- 9.2 Finding the Characteristics of a Sinusoidal Voltage 308
- 9.3 Translating a Sine Expression to a Cosine Expression 308
- 9.4 Calculating the rms Value of a Triangular Waveform 308
- 9.5 Adding Cosines Using Phasors 314
- 9.6 Combining Impedances in Series 321
- 9.7 Combining Impedances in Series and in Parallel 323
- 9.8 Using a Delta-to-Wye Transform in the Frequency Domain 325
- 9.9 Performing Source Transformations in the Frequency Domain 327
- 9.10 Finding a Thévenin Equivalent in the Frequency Domain 328
- 9.11 Using the Node-Voltage Method in the Frequency Domain 330
- 9.12 Using the Mesh-Current Method in the Frequency Domain 331
- 9.13 Analyzing a Linear Transformer in the Frequency Domain 335
- 9.14 Analyzing an Ideal Transformer Circuit in the Frequency Domain 340
- 9.15 Using Phasor Diagrams to Analyze a Circuit 342
- 9.16 Using Phasor Diagrams to Analyze Capacitive Loading Effects 343

## Chapter 10

- 10.1 Calculating Average and Reactive Power 364
- 10.2 Making Power Calculations Involving Household Appliances 365
- 10.3 Determining Average Power Delivered to a Resistor by Sinusoidal Voltage 367
- 10.4 Calculating Complex Power 369
- 10.5 Calculating Average and Reactive Power 372
- 10.6 Calculating Power in Parallel Loads 373
- 10.7 Balancing Power Delivered with Power Absorbed in an ac Circuit 374
- 10.8 Determining Maximum Power Transfer without Load Restrictions 378
- 10.9 Determining Maximum Power Transfer with Load Impedance Restriction 379
- 10.10 Finding Maximum Power Transfer with Impedance Angle Restrictions 380
- 10.11 Finding Maximum Power Transfer in a Circuit with an Ideal Transformer 381

**Chapter 11**

- 11.1 Analyzing a Wye-Wye Circuit 403
- 11.2 Analyzing a Wye-Delta Circuit 406
- 11.3 Calculating Power in a Three-Phase Wye-Wye Circuit 411
- 11.4 Calculating Power in a Three-Phase Wye-Delta Circuit 411
- 11.5 Calculating Three-Phase Power with an Unspecified Load 412
- 11.6 Computing Wattmeter Readings in Three-Phase Circuits 415

**Chapter 12**

- 12.1 Using Step Functions to Represent a Function of Finite Duration 430

**Chapter 13**

- 13.1 Deriving the Transfer Function of a Circuit 483
- 13.2 Analyzing the Transfer Function of a Circuit 485
- 13.3 Using the Convolution Integral to Find an Output Signal 491
- 13.4 Using the Transfer Function to Find the Steady-State Sinusoidal Response 495

**Chapter 14**

- 14.1 Designing a Low-Pass Filter 527
- 14.2 Designing a Series  $RC$  Low-Pass Filter 528
- 14.3 Designing a Series  $RL$  High-Pass Filter 532
- 14.4 Loading the Series  $RL$  High-Pass Filter 532
- 14.5 Designing a Bandpass Filter 538
- 14.6 Designing a Parallel  $RLC$  Bandpass Filter 539
- 14.7 Determining Effect of a Nonideal Voltage Source on a  $RLC$  Bandpass Filter 540
- 14.8 Designing a Series  $RLC$  Bandreject Filter 546

**Chapter 15**

- 15.1 Designing a Low-Pass Op Amp Filter 559
- 15.2 Designing a High-Pass Op Amp Filter 561
- 15.3 Scaling a Series  $RLC$  Circuit 563
- 15.4 Scaling a Prototype Low-Pass Op Amp Filter 563
- 15.5 Designing a Broadband Bandpass Op Amp Filter 567
- 15.6 Designing a Broadband Bandreject Op Amp Filter 570
- 15.7 Designing a Fourth-Order Low-Pass Op Amp Filter 574
- 15.8 Calculating Butterworth Transfer Functions 577

- 15.9 Designing a Fourth-Order Low-Pass Butterworth Filter 579
- 15.10 Determining the Order of a Butterworth Filter 582
- 15.11 An Alternate Approach to Determining the Order of a Butterworth Filter 582
- 15.12 Designing a High- $Q$  Bandpass Filter 586
- 15.13 Designing a High- $Q$  Bandreject Filter 588

**Chapter 16**

- 16.1 Finding the Fourier Series of a Triangular Waveform with No Symmetry 607
- 16.2 Finding the Fourier Series of an Odd Function with Symmetry 614
- 16.3 Calculating Forms of the Trigonometric Fourier Series for Periodic Voltage 616
- 16.4 Calculating Average Power for a Circuit with a Periodic Voltage Source 623
- 16.5 Estimating the rms Value of a Periodic Function 625
- 16.6 Finding the Exponential Form of the Fourier Series 627

**Chapter 17**

- 17.1 Using the Fourier Transform to Find the Transient Response 660
- 17.2 Using the Fourier Transform to Find the Sinusoidal Steady-State Response 661
- 17.3 Applying Parseval's Theorem 664
- 17.4 Applying Parseval's Theorem to an Ideal Bandpass Filter 665
- 17.5 Applying Parseval's Theorem to a Low-Pass Filter 666

**Chapter 18**

- 18.1 Finding the  $z$  Parameters of a Two-Port Circuit 679
- 18.2 Finding the  $a$  Parameters from Measurements 681
- 18.3 Finding  $h$  Parameters from Measurements and Table 18.1 684
- 18.4 Analyzing a Terminated Two-Port Circuit 690
- 18.5 Analyzing Cascaded Two-Port Circuits 694

*This page intentionally left blank*



# Preface

The first edition of *Electric Circuits*, an introductory circuits text, was published in 1983. It included 100 worked examples and about 600 problems. It did not include a student workbook, supplements for PSpice or MultiSim, or any web support. Support for instructors was limited to a solution manual for the problems and enlarged copies of many text figures, suitable for making transparencies.

Much has changed in the 31 years since *Electric Circuits* first appeared, and during that time this text has evolved to better meet the needs of both students and their instructors. As an example, the text now includes about 150 worked examples, about 1850 problems, and extensive supplements and web content. The tenth edition is designed to revise and improve the material presented in the text, in its supplements, and on the web. Yet the fundamental goals of the text are unchanged. These goals are:

- To build an understanding of concepts and ideas explicitly in terms of previous learning. Students are constantly challenged by the need to layer new concepts on top of previous concepts they may still be struggling to master. This text provides an important focus on helping students understand how new concepts are related to and rely upon concepts previously presented.
- To emphasize the relationship between conceptual understanding and problem-solving approaches. Developing problem-solving skills continues to be the central challenge in a first-year circuits course. In this text we include numerous Examples that present problem-solving techniques followed by Assessment Problems that enable students to test their mastery of the material and techniques introduced. The problem-solving process we illustrate is based on concepts rather than the use of rote procedures. This encourages students to think about a problem before attempting to solve it.
- To provide students with a strong foundation of engineering practices. There are limited opportunities in a first-year circuit analysis course to introduce students to realistic engineering experiences. We continue to take advantage of the opportunities that do exist by including problems and examples that use realistic component values and represent realizable circuits. We include many problems related to the Practical Perspective problems that begin each chapter. We also include problems intended to stimulate the students' interest in engineering, where the problems require the type of insight typical of a practicing engineer.

## WHY THIS EDITION?

The tenth edition revision of *Electric Circuits* began with a thorough review of the text. This review provided a clear picture of what matters most to instructors and their students and led to the following changes:

- Problem solving is fundamental to the study of circuit analysis. Having a wealth of new problems to assign and work is a key to success in any circuits course. Therefore, existing end-of-chapter problems were revised, and new end-of-chapter problems were added. As a result, more than 40% of the problems in the tenth edition have never appeared in any previous edition of the text.



- Both students and instructors want to know how the generalized techniques presented in a first-year circuit analysis course relate to problems faced by practicing engineers. The Practical Perspective problems provide this connection between circuit analysis and the real world. We have created new Practical Perspective problems for Chapters 2, 3, 6, 7, 8, and 10. Many of the new problems represent the world of the 21st century. Each Practical Perspective problem is solved, at least in part, at the end of the chapter, and additional end-of-chapter problems can be assigned to allow students to explore the Practical Perspective topic further.
- The PSpice and Multisim manuals have been revised to include screenshots from the most recent versions of these software simulation applications. Each manual presents the simulation material in the same order as the material is presented in the text. These manuals continue to include examples of circuits to be simulated that are drawn directly from the text. The text continues to indicate end-of-chapter problems that are good candidates for simulation using either PSpice or Multisim.
- Students who could benefit from additional examples and practice problems can use the Student Workbook, which has been revised to reflect changes to the tenth edition of the text. This workbook has examples and problems covering the following material: balancing power, simple resistive circuits, node voltage method, mesh current method, Thévenin and Norton equivalents, op amp circuits, first-order circuits, second-order circuits, AC steady-state analysis, and Laplace transform circuit analysis.
- The Student Workbook now includes access to Video Solutions, complete, step-by-step solution walkthroughs to representative homework problems.
- Learning Catalytics, a “bring your own device” student engagement, assessment, and classroom intelligence system is now available with the tenth edition. With Learning Catalytics you can:
  - Use open-ended questions to get into the minds of students to understand what they do or don’t know and adjust lectures accordingly.
  - Use a wide variety of question types to sketch a graph, annotate a circuit diagram, compose numeric or algebraic answers, and more.
  - Access rich analytics to understand student performance.
  - Use pre-built questions or add your own to make Learning Catalytics fit your course exactly.
- MasteringEngineering is an online tutorial and assessment program that provides students with personalized feedback and hints and instructors with diagnostics to track students’ progress. With the tenth edition, MasteringEngineering will offer new tutorial homework problems, Coaching Activities, and Adaptive Follow-Up assignments. Visit [www.masteringengineering.com](http://www.masteringengineering.com) for more information.

## HALLMARK FEATURES

### Chapter Problems

Users of *Electric Circuits* have consistently rated the Chapter Problems as one of the book’s most attractive features. In the tenth edition, there are over 1650 end-of-chapter problems with approximately 40% that have never appeared in a previous edition. Problems are organized at the end of each chapter by section.

## **Practical Perspectives**

The tenth edition continues the use of Practical Perspectives introduced with the chapter openers. They offer examples of real-world circuits, taken from real-world devices. The Practical Perspectives for six of the chapters are brand new to this edition. Every chapter begins with a brief description of a practical application of the material that follows. Once the chapter material is presented, the chapter concludes with a quantitative analysis of the Practical Perspective application. A group of end-of-chapter problems directly relates to the Practical Perspective application. Solving some of these problems enables you to understand how to apply the chapter contents to the solution of a real-world problem.

## **Assessment Problems**

Each chapter begins with a set of chapter objectives. At key points in the chapter, you are asked to stop and assess your mastery of a particular objective by solving one or more assessment problems. The answers to all of the assessment problems are given at the conclusion of each problem, so you can check your work. If you are able to solve the assessment problems for a given objective, you have mastered that objective. If you need more practice, several end-of-chapter problems that relate to the objective are suggested at the conclusion of the assessment problems.

## **Examples**

Every chapter includes many examples that illustrate the concepts presented in the text in the form of a numeric example. There are nearly 150 examples in this text. The examples are intended to illustrate the application of a particular concept, and also to encourage good problem-solving skills.

## **Fundamental Equations and Concepts**

Throughout the text, you will see fundamental equations and concepts set apart from the main text. This is done to help you focus on some of the key principles in electric circuits and to help you navigate through the important topics.

## **Integration of Computer Tools**

Computer tools can assist students in the learning process by providing a visual representation of a circuit's behavior, validating a calculated solution, reducing the computational burden of more complex circuits, and iterating toward a desired solution using parameter variation. This computational support is often invaluable in the design process. The tenth edition includes the support of PSpice® and Multisim®, both popular computer tools for circuit simulation and analysis. Chapter problems suited for exploration with PSpice and Multisim are marked accordingly.

## **Design Emphasis**

The tenth edition continues to support the emphasis on the design of circuits in many ways. First, many of the Practical Perspective discussions focus on the design aspects of the circuits. The accompanying Chapter Problems continue the discussion of the design issues in these practical examples. Second, design-oriented Chapter Problems have been labeled explicitly, enabling students and instructors to identify those problems with a design focus. Third, the identification of problems suited to exploration with PSpice or Multisim suggests design opportunities using these

software tools. Fourth, some problems in nearly every chapter focus on the use of realistic component values in achieving a desired circuit design. Once such a problem has been analyzed, the student can proceed to a laboratory to build and test the circuit, comparing the analysis with the measured performance of the actual circuit.

### Accuracy

All text and problems in the tenth edition have undergone our strict hallmark accuracy checking process, to ensure the most error-free book possible.

## RESOURCES FOR STUDENTS

**MasteringEngineering.** MasteringEngineering provides tutorial homework problems designed to emulate the instructor's office hour environment, guiding students through engineering concepts with self-paced individualized coaching. These in-depth tutorial homework problems provide students with feedback specific to their errors and optional hints that break problems down into simpler steps. Visit [www.masteringengineering.com](http://www.masteringengineering.com) for more information.

**Student Workbook.** This resource teaches students techniques for solving problems presented in the text. Organized by concepts, this is a valuable problem-solving resource for all levels of students.

The Student Workbook now includes access to Video Solutions, complete, step-by-step solution walkthroughs to representative homework problems.

**Introduction to Multisim and Introduction to PSpice Manuals**—Updated for the tenth edition, these manuals are excellent resources for those wishing to integrate PSpice or Multisim into their classes.

## RESOURCES FOR INSTRUCTORS

All instructor resources are available for download at [www.pearsonhighered.com](http://www.pearsonhighered.com). If you are in need of a login and password for this site, please contact your local Pearson representative.

**Instructor Solutions Manual**—Fully worked-out solutions to Assessment Problems and end-of-chapter problems.

**PowerPoint lecture images**—All figures from the text are available in PowerPoint for your lecture needs. An additional set of full lecture slides with embedded assessment questions are available upon request.

**MasteringEngineering.** This online tutorial and assessment program allows you to integrate dynamic homework with automated grading and personalized feedback. MasteringEngineering allows you to easily track the performance of your entire class on an assignment-by-assignment basis, or the detailed work of an individual student. For more information visit [www.masteringengineering.com](http://www.masteringengineering.com).

**Learning Catalytics**—This “bring your own device” student engagement, assessment and classroom intelligence system enables you to measure student learning during class, and adjust your lectures accordingly. A wide variety of question and answer types allows you to author your own questions, or you can use questions already authored into the system. For more information visit [www.learningcatalytics.com](http://www.learningcatalytics.com).

## PREREQUISITES

In writing the first 12 chapters of the text, we have assumed that the reader has taken a course in elementary differential and integral calculus. We have also assumed that the reader has had an introductory physics course, at either the high school or university level, that introduces the concepts of energy, power, electric charge, electric current, electric potential, and electromagnetic fields. In writing the final six chapters, we have assumed the student has had, or is enrolled in, an introductory course in differential equations.

## COURSE OPTIONS

The text has been designed for use in a one-semester, two-semester, or a three-quarter sequence.

- *Single-semester course:* After covering Chapters 1–4 and Chapters 6–10 (omitting Sections 7.7 and 8.5) the instructor can choose from Chapter 5 (operational amplifiers), Chapter 11 (three-phase circuits), Chapters 13 and 14 (Laplace methods), and Chapter 18 (Two-Port Circuits) to develop the desired emphasis.
- *Two-semester sequence:* Assuming three lectures per week, the first nine chapters can be covered during the first semester, leaving Chapters 10–18 for the second semester.
- *Academic quarter schedule:* The book can be subdivided into three parts: Chapters 1–6, Chapters 7–12, and Chapters 13–18.

The introduction to operational amplifier circuits in Chapter 5 can be omitted without interfering with the reading of subsequent chapters. For example, if Chapter 5 is omitted, the instructor can simply skip Section 7.7, Section 8.5, Chapter 15, and those assessment problems and end-of-chapter problems in the chapters following Chapter 5 that pertain to operational amplifiers.

There are several appendixes at the end of the book to help readers make effective use of their mathematical background. Appendix A reviews Cramer's method of solving simultaneous linear equations and simple matrix algebra; complex numbers are reviewed in Appendix B; Appendix C contains additional material on magnetically coupled coils and ideal transformers; Appendix D contains a brief discussion of the decibel; Appendix E is dedicated to Bode diagrams; Appendix F is devoted to an abbreviated table of trigonometric identities that are useful in circuit analysis; and an abbreviated table of useful integrals is given in Appendix G. Appendix H provides tables of common standard component values for resistors, inductors, and capacitors, to be used in solving many end-of-chapter problems. Selected Answers provides answers to selected end-of-chapter problems.

## ACKNOWLEDGMENTS

There were many hard-working people behind the scenes at our publisher who deserve our thanks and gratitude for their efforts on behalf of the tenth edition. At Pearson, we would like to thank Andrew Gilfillan, Rose Kernan, Gregory Dulles, Tim Galligan, and Scott Disanno for their continued support and encouragement, their professional demeanor, their willingness to lend an ear, and their months of long hours and no weekends. The authors would also like to acknowledge the staff at Integra Software Solutions for their dedication and hard work in typesetting this text. The authors would also like to thank Kurt Norlin for his help in accuracy checking the text and problems.

We are very grateful for the many instructors and students who have done formal reviews of the text or offered positive feedback and suggestions for improvement more informally. We are pleased to receive email from instructors and students who use the book, even when they are pointing out an error we failed to catch in the review process. We have been contacted by people who use our text from all over the world, and we thank all of you for taking the time to do so. We use as many of your suggestions as possible to continue to improve the content, the pedagogy, and the presentation in this text. We are privileged to have the opportunity to impact the educational experience of the many thousands of future engineers who will use this text.

JAMES W. NILSSON  
SUSAN A. RIEDEL



# ELECTRIC CIRCUITS

TENTH EDITION

## CHAPTER CONTENTS

- 1.1 **Electrical Engineering: An Overview** p. 4
- 1.2 **The International System of Units** p. 8
- 1.3 **Circuit Analysis: An Overview** p. 10
- 1.4 **Voltage and Current** p. 11
- 1.5 **The Ideal Basic Circuit Element** p. 12
- 1.6 **Power and Energy** p. 14

## ✓ CHAPTER OBJECTIVES

- 1 Understand and be able to use SI units and the standard prefixes for powers of 10.
- 2 Know and be able to use the definitions of *voltage* and *current*.
- 3 Know and be able to use the definitions of *power* and *energy*.
- 4 Be able to use the passive sign convention to calculate the power for an ideal basic circuit element given its voltage and current.



# Circuit Variables

**Electrical engineering** is an exciting and challenging profession for anyone who has a genuine interest in, and aptitude for, applied science and mathematics. Over the past century and a half, electrical engineers have played a dominant role in the development of systems that have changed the way people live and work. Satellite communication links, telephones, digital computers, televisions, diagnostic and surgical medical equipment, assembly-line robots, and electrical power tools are representative components of systems that define a modern technological society. As an electrical engineer, you can participate in this ongoing technological revolution by improving and refining these existing systems and by discovering and developing new systems to meet the needs of our ever-changing society.

As you embark on the study of circuit analysis, you need to gain a feel for where this study fits into the hierarchy of topics that comprise an introduction to electrical engineering. Hence we begin by presenting an overview of electrical engineering, some ideas about an engineering point of view as it relates to circuit analysis, and a review of the international system of units.

We then describe generally what circuit analysis entails. Next, we introduce the concepts of voltage and current. We follow these concepts with discussion of an ideal basic element and the need for a polarity reference system. We conclude the chapter by describing how current and voltage relate to power and energy.

## Practical Perspective

### Balancing Power

One of the most important skills you will develop is the ability to check your answers for the circuits you design and analyze using the tools developed in this text. A common method used to check for valid answers is to balance the power in the circuit. The linear circuits we study have no net power, so the sum of the power associated with each circuit component must be zero. If the total power for the circuit is zero, we say that the power balances, but if the total power is not zero, we need to find the errors in our calculation.

As an example, we will consider a very simple model for the distribution of electricity to a typical home, as shown

below. (Note that a more realistic model will be investigated in the Practical Perspective for Chapter 9.) The components labeled a and b represent the electrical source to the home. The components labeled c, d, and e represent the wires that carry the electrical current from the source to the devices in the home requiring electrical power. The components labeled f, g, and h represent lamps, televisions, hair dryers, refrigerators, and other devices that require power.

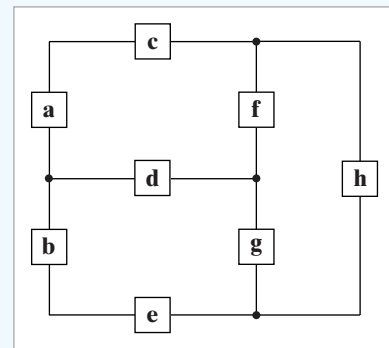
Once we have introduced the concepts of voltage, current, power, and energy, we will examine this circuit model in detail, and use a power balance to determine whether the results of analyzing this circuit are correct.



romakoma / Shutterstock



Elena Elisseeva / Alamy



## 1.1 Electrical Engineering: An Overview

Electrical engineering is the profession concerned with systems that produce, transmit, and measure electric signals. Electrical engineering combines the physicist's models of natural phenomena with the mathematician's tools for manipulating those models to produce systems that meet practical needs. Electrical systems pervade our lives; they are found in homes, schools, workplaces, and transportation vehicles everywhere. We begin by presenting a few examples from each of the five major classifications of electrical systems:

- communication systems
- computer systems
- control systems
- power systems
- signal-processing systems

Then we describe how electrical engineers analyze and design such systems.

**Communication systems** are electrical systems that generate, transmit, and distribute information. Well-known examples include television equipment, such as cameras, transmitters, receivers, and VCRs; radio telescopes, used to explore the universe; satellite systems, which return images of other planets and our own; radar systems, used to coordinate plane flights; and telephone systems.

Figure 1.1 depicts the major components of a modern telephone system. Starting at the left of the figure, inside a telephone, a microphone turns sound waves into electric signals. These signals are carried to a switching center where they are combined with the signals from tens, hundreds, or thousands of other telephones. The combined signals leave the switching center; their form depends on the distance they must travel. In our example, they are sent through wires in underground coaxial cables to a microwave transmission station. Here, the signals are transformed into microwave frequencies and broadcast from a transmission antenna through air and space, via a communications satellite, to a receiving antenna. The microwave receiving station translates the microwave signals into a form suitable for further transmission, perhaps as pulses of light to be sent through fiber-optic cable. On arrival at the second switching center, the combined signals are separated, and each is routed to the appropriate telephone, where an earphone acts as a speaker to convert the received electric signals back into sound waves. At each stage of the process, electric circuits operate on the signals. Imagine the challenge involved in designing, building, and operating each circuit in a way that guarantees that all of the hundreds of thousands of simultaneous calls have high-quality connections.

**Computer systems** use electric signals to process information ranging from word processing to mathematical computations. Systems range in size and power from pocket calculators to personal computers to supercomputers that perform such complex tasks as processing weather data and modeling chemical interactions of complex organic molecules. These systems include networks of microcircuits, or integrated circuits—postage-stamp-sized assemblies of hundreds, thousands, or millions of electrical components that often operate at speeds and power levels close to fundamental physical limits, including the speed of light and the thermodynamic laws.

**Control systems** use electric signals to regulate processes. Examples include the control of temperatures, pressures, and flow rates in an oil refinery; the fuel-air mixture in a fuel-injected automobile engine; mechanisms such as the motors, doors, and lights in elevators; and the locks in the

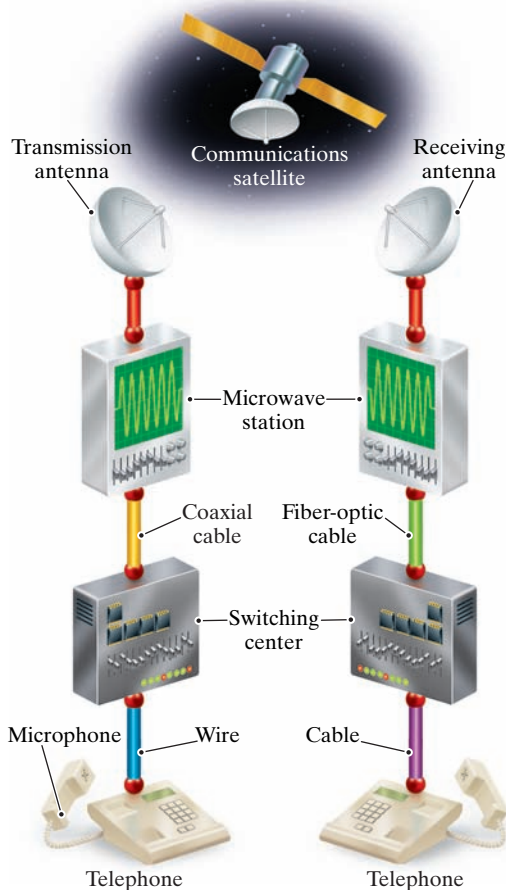


Figure 1.1 ▲ A telephone system.

Panama Canal. The autopilot and autoland systems that help to fly and land airplanes are also familiar control systems.

**Power systems** generate and distribute electric power. Electric power, which is the foundation of our technology-based society, usually is generated in large quantities by nuclear, hydroelectric, and thermal (coal-, oil-, or gas-fired) generators. Power is distributed by a grid of conductors that crisscross the country. A major challenge in designing and operating such a system is to provide sufficient redundancy and control so that failure of any piece of equipment does not leave a city, state, or region completely without power.

**Signal-processing systems** act on electric signals that represent information. They transform the signals and the information contained in them into a more suitable form. There are many different ways to process the signals and their information. For example, image-processing systems gather massive quantities of data from orbiting weather satellites, reduce the amount of data to a manageable level, and transform the remaining data into a video image for the evening news broadcast. A computerized tomography (CT) scan is another example of an image-processing system. It takes signals generated by a special X-ray machine and transforms them into an image such as the one in Fig. 1.2. Although the original X-ray signals are of little use to a physician, once they are processed into a recognizable image the information they contain can be used in the diagnosis of disease and injury.

Considerable interaction takes place among the engineering disciplines involved in designing and operating these five classes of systems. Thus communications engineers use digital computers to control the flow of information. Computers contain control systems, and control systems contain computers. Power systems require extensive communications systems to coordinate safely and reliably the operation of components, which may be spread across a continent. A signal-processing system may involve a communications link, a computer, and a control system.

A good example of the interaction among systems is a commercial airplane, such as the one shown in Fig. 1.3. A sophisticated communications system enables the pilot and the air traffic controller to monitor the plane's location, permitting the air traffic controller to design a safe flight path for all of the nearby aircraft and enabling the pilot to keep the plane on its designated path. On the newest commercial airplanes, an onboard computer system is used for managing engine functions, implementing the navigation and flight control systems, and generating video information screens in the cockpit. A complex control system uses cockpit commands to adjust the position and speed of the airplane, producing the appropriate signals to the engines and the control surfaces (such as the wing flaps, ailerons, and rudder) to ensure the plane remains safely airborne and on the desired flight path. The plane must have its own power system to stay aloft and to provide and distribute the electric power needed to keep the cabin lights on, make the coffee, and show the movie. Signal-processing systems reduce the noise in air traffic communications and transform information about the plane's location into the more meaningful form of a video display in the cockpit. Engineering challenges abound in the design of each of these systems and their integration into a coherent whole. For example, these systems must operate in widely varying and unpredictable environmental conditions. Perhaps the most important engineering challenge is to guarantee that sufficient redundancy is incorporated in the designs to ensure that passengers arrive safely and on time at their desired destinations.

Although electrical engineers may be interested primarily in one area, they must also be knowledgeable in other areas that interact with this area of interest. This interaction is part of what makes electrical

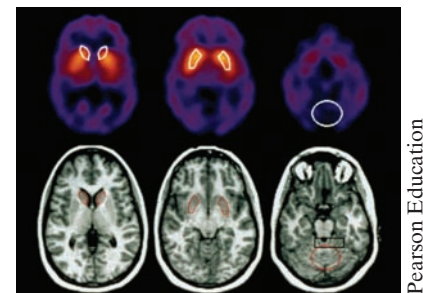


Figure 1.2 ▲ A CT scan of an adult head.



Figure 1.3 ▲ An airplane.



engineering a challenging and exciting profession. The emphasis in engineering is on making things work, so an engineer is free to acquire and use any technique, from any field, that helps to get the job done.

## Circuit Theory

In a field as diverse as electrical engineering, you might well ask whether all of its branches have anything in common. The answer is yes—electric circuits. An **electric circuit** is a mathematical model that approximates the behavior of an actual electrical system. As such, it provides an important foundation for learning—in your later courses and as a practicing engineer—the details of how to design and operate systems such as those just described. The models, the mathematical techniques, and the language of circuit theory will form the intellectual framework for your future engineering endeavors.

Note that the term *electric circuit* is commonly used to refer to an actual electrical system as well as to the model that represents it. In this text, when we talk about an electric circuit, we always mean a model, unless otherwise stated. It is the modeling aspect of circuit theory that has broad applications across engineering disciplines.

Circuit theory is a special case of electromagnetic field theory: the study of static and moving electric charges. Although generalized field theory might seem to be an appropriate starting point for investigating electric signals, its application is not only cumbersome but also requires the use of advanced mathematics. Consequently, a course in electromagnetic field theory is not a prerequisite to understanding the material in this book. We do, however, assume that you have had an introductory physics course in which electrical and magnetic phenomena were discussed.

Three basic assumptions permit us to use circuit theory, rather than electromagnetic field theory, to study a physical system represented by an electric circuit. These assumptions are as follows:

1. *Electrical effects happen instantaneously throughout a system.* We can make this assumption because we know that electric signals travel at or near the speed of light. Thus, if the system is physically small, electric signals move through it so quickly that we can consider them to affect every point in the system simultaneously. A system that is small enough so that we can make this assumption is called a **lumped-parameter system**.
2. *The net charge on every component in the system is always zero.* Thus no component can collect a net excess of charge, although some components, as you will learn later, can hold equal but opposite separated charges.
3. *There is no magnetic coupling between the components in a system.* As we demonstrate later, magnetic coupling can occur *within* a component.

That's it; there are no other assumptions. Using circuit theory provides simple solutions (of sufficient accuracy) to problems that would become hopelessly complicated if we were to use electromagnetic field theory. These benefits are so great that engineers sometimes specifically design electrical systems to ensure that these assumptions are met. The importance of assumptions 2 and 3 becomes apparent after we introduce the basic circuit elements and the rules for analyzing interconnected elements.

However, we need to take a closer look at assumption 1. The question is, “How small does a physical system have to be to qualify as a lumped-parameter system?” We can get a quantitative handle on the question by noting that electric signals propagate by wave phenomena. If the wavelength of the signal is large compared to the physical dimensions of the

system, we have a lumped-parameter system. The wavelength  $\lambda$  is the velocity divided by the repetition rate, or **frequency**, of the signal; that is,  $\lambda = c/f$ . The frequency  $f$  is measured in hertz (Hz). For example, power systems in the United States operate at 60 Hz. If we use the speed of light ( $c = 3 \times 10^8$  m/s) as the velocity of propagation, the wavelength is  $5 \times 10^6$  m. If the power system of interest is physically smaller than this wavelength, we can represent it as a lumped-parameter system and use circuit theory to analyze its behavior. How do we define *smaller*? A good rule is the *rule of 1/10th*: If the dimension of the system is 1/10th (or smaller) of the dimension of the wavelength, you have a lumped-parameter system. Thus, as long as the physical dimension of the power system is less than  $5 \times 10^5$  m, we can treat it as a lumped-parameter system.

On the other hand, the propagation frequency of radio signals is on the order of  $10^9$  Hz. Thus the wavelength is 0.3 m. Using the rule of 1/10th, the relevant dimensions of a communication system that sends or receives radio signals must be less than 3 cm to qualify as a lumped-parameter system. Whenever any of the pertinent physical dimensions of a system under study approaches the wavelength of its signals, we must use electromagnetic field theory to analyze that system. Throughout this book we study circuits derived from lumped-parameter systems.

## Problem Solving

As a practicing engineer, you will not be asked to solve problems that have already been solved. Whether you are trying to improve the performance of an existing system or creating a new system, you will be working on unsolved problems. As a student, however, you will devote much of your attention to the discussion of problems already solved. By reading about and discussing how these problems were solved in the past, and by solving related homework and exam problems on your own, you will begin to develop the skills to successfully attack the unsolved problems you'll face as a practicing engineer.

Some general problem-solving procedures are presented here. Many of them pertain to thinking about and organizing your solution strategy *before* proceeding with calculations.

1. *Identify what's given and what's to be found.* In problem solving, you need to know your destination before you can select a route for getting there. What is the problem asking you to solve or find? Sometimes the goal of the problem is obvious; other times you may need to paraphrase or make lists or tables of known and unknown information to see your objective.

The problem statement may contain extraneous information that you need to weed out before proceeding. On the other hand, it may offer incomplete information or more complexities than can be handled given the solution methods at your disposal. In that case, you'll need to make assumptions to fill in the missing information or simplify the problem context. Be prepared to circle back and reconsider supposedly extraneous information and/or your assumptions if your calculations get bogged down or produce an answer that doesn't seem to make sense.

2. *Sketch a circuit diagram or other visual model.* Translating a verbal problem description into a visual model is often a useful step in the solution process. If a circuit diagram is already provided, you may need to add information to it, such as labels, values, or reference directions. You may also want to redraw the circuit in a simpler, but equivalent, form. Later in this text you will learn the methods for developing such simplified equivalent circuits.

3. *Think of several solution methods and decide on a way of choosing among them.* This course will help you build a collection of analytical tools, several of which may work on a given problem. But one method may produce fewer equations to be solved than another, or it may require only algebra instead of calculus to reach a solution. Such efficiencies, if you can anticipate them, can streamline your calculations considerably. Having an alternative method in mind also gives you a path to pursue if your first solution attempt bogs down.
4. *Calculate a solution.* Your planning up to this point should have helped you identify a good analytical method and the correct equations for the problem. Now comes the solution of those equations. Paper-and-pencil, calculator, and computer methods are all available for performing the actual calculations of circuit analysis. Efficiency and your instructor's preferences will dictate which tools you should use.
5. *Use your creativity.* If you suspect that your answer is off base or if the calculations seem to go on and on without moving you toward a solution, you should pause and consider alternatives. You may need to revisit your assumptions or select a different solution method. Or, you may need to take a less-conventional problem-solving approach, such as working backward from a solution. This text provides answers to all of the Assessment Problems and many of the Chapter Problems so that you may work backward when you get stuck. In the real world, you won't be given answers in advance, but you may have a desired problem outcome in mind from which you can work backward. Other creative approaches include allowing yourself to see parallels with other types of problems you've successfully solved, following your intuition or hunches about how to proceed, and simply setting the problem aside temporarily and coming back to it later.
6. *Test your solution.* Ask yourself whether the solution you've obtained makes sense. Does the magnitude of the answer seem reasonable? Is the solution physically realizable? You may want to go further and rework the problem via an alternative method. Doing so will not only test the validity of your original answer, but will also help you develop your intuition about the most efficient solution methods for various kinds of problems. In the real world, safety-critical designs are always checked by several independent means. Getting into the habit of checking your answers will benefit you as a student and as a practicing engineer.

These problem-solving steps cannot be used as a recipe to solve every problem in this or any other course. You may need to skip, change the order of, or elaborate on certain steps to solve a particular problem. Use these steps as a guideline to develop a problem-solving style that works for you.

## 1.2 The International System of Units

Engineers compare theoretical results to experimental results and compare competing engineering designs using quantitative measures. Modern engineering is a multidisciplinary profession in which teams of engineers work together on projects, and they can communicate their results in a meaningful way only if they all use the same units of measure. The International System of Units (abbreviated SI) is used by all the major engineering societies and most engineers throughout the world; hence we use it in this book.



**TABLE 1.1 The International System of Units (SI)**

Quantity	Basic Unit	Symbol
Length	meter	m
Mass	kilogram	kg
Time	second	s
Electric current	ampere	A
Thermodynamic temperature	degree kelvin	K
Amount of substance	mole	mol
Luminous intensity	candela	cd

National Institute of Standards and Technology Special Publication 330, 2008 Edition, Natl. Inst. Stand. Technol. Spec. Pub. 330, 2008 Ed., 96 pages (March 2008)

The SI units are based on seven *defined* quantities:

- length
- mass
- time
- electric current
- thermodynamic temperature
- amount of substance
- luminous intensity

These quantities, along with the basic unit and symbol for each, are listed in Table 1.1. Although not strictly SI units, the familiar time units of minute (60 s), hour (3600 s), and so on are often used in engineering calculations. In addition, defined quantities are combined to form **derived** units. Some, such as force, energy, power, and electric charge, you already know through previous physics courses. Table 1.2 lists the derived units used in this book.

In many cases, the SI unit is either too small or too large to use conveniently. Standard prefixes corresponding to powers of 10, as listed in Table 1.3, are then applied to the basic unit. All of these prefixes are correct, but engineers often use only the ones for powers divisible by 3; thus centi, deci, deka, and hecto are used rarely. Also, engineers often select the prefix that places the base number in the range between 1 and 1000. Suppose that a time calculation yields a result of  $10^{-5}$  s, that is, 0.00001 s. Most engineers would describe this quantity as  $10 \mu\text{s}$ , that is,  $10^{-5} = 10 \times 10^{-6}$  s, rather than as 0.01 ms or 10,000,000 ps.

**TABLE 1.2 Derived Units in SI**

Quantity	Unit Name (Symbol)	Formula
Frequency	hertz (Hz)	$\text{s}^{-1}$
Force	newton (N)	$\text{kg} \cdot \text{m}/\text{s}^2$
Energy or work	joule (J)	$\text{N} \cdot \text{m}$
Power	watt (W)	$\text{J}/\text{s}$
Electric charge	coulomb (C)	$\text{A} \cdot \text{s}$
Electric potential	volt (V)	$\text{J}/\text{C}$
Electric resistance	ohm ( $\Omega$ )	$\text{V}/\text{A}$
Electric conductance	siemens (S)	$\text{A}/\text{V}$
Electric capacitance	farad (F)	$\text{C}/\text{V}$
Magnetic flux	weber (Wb)	$\text{V} \cdot \text{s}$
Inductance	henry (H)	$\text{Wb}/\text{A}$

National Institute of Standards and Technology Special Publication 330, 2008 Edition, Natl. Inst. Stand. Technol. Spec. Pub. 330, 2008 Ed., 96 pages (March 2008)

**TABLE 1.3 Standardized Prefixes to Signify Powers of 10**

Prefix	Symbol	Power
atto	a	$10^{-18}$
femto	f	$10^{-15}$
pico	p	$10^{-12}$
nano	n	$10^{-9}$
micro	$\mu$	$10^{-6}$
milli	m	$10^{-3}$
centi	c	$10^{-2}$
deci	d	$10^{-1}$
deka	da	10
hecto	h	$10^2$
kilo	k	$10^3$
mega	M	$10^6$
giga	G	$10^9$
tera	T	$10^{12}$

National Institute of Standards and Technology Special Publication 330, 2008 Edition, Natl. Inst. Stand. Technol. Spec. Pub. 330, 2008 Ed., 96 pages (March 2008)

Example 1.1 illustrates a method for converting from one set of units to another and also uses power-of-ten prefixes.

### Example 1.1 Using SI Units and Prefixes for Powers of 10

If a signal can travel in a cable at 80% of the speed of light, what length of cable, in inches, represents 1 ns?

Therefore, a signal traveling at 80% of the speed of light will cover 9.45 inches of cable in 1 nanosecond.

#### Solution

First, note that  $1 \text{ ns} = 10^{-9} \text{ s}$ . Also, recall that the speed of light  $c = 3 \times 10^8 \text{ m/s}$ . Then, 80% of the speed of light is  $0.8c = (0.8)(3 \times 10^8) = 2.4 \times 10^8 \text{ m/s}$ . Using a product of ratios, we can convert 80% of the speed of light from meters-per-second to inches-per-nanosecond. The result is the distance in inches traveled in 1 ns:

$$\begin{aligned} & \frac{2.4 \times 10^8 \text{ meters}}{1 \text{ second}} \cdot \frac{1 \text{ second}}{10^9 \text{ nanoseconds}} \cdot \frac{100 \text{ centimeters}}{1 \text{ meter}} \cdot \frac{1 \text{ inch}}{2.54 \text{ centimeters}} \\ &= \frac{(2.4 \times 10^8)(100)}{(10^9)(2.54)} = 9.45 \text{ inches/nanosecond} \end{aligned}$$

## ASSESSMENT PROBLEMS

### Objective 1—Understand and be able to use SI units and the standard prefixes for powers of 10

**1.1** Assume a telephone signal travels through a cable at two-thirds the speed of light. How long does it take the signal to get from New York City to Miami if the distance is approximately 1100 miles?

**Answer:** 8.85 ms.

*NOTE:* Also try Chapter Problems 1.1, 1.3, and 1.5.

**1.2** How many dollars per millisecond would the federal government have to collect to retire a deficit of \$100 billion in one year?

**Answer:** \$3.17/ms.

## 1.3 Circuit Analysis: An Overview

Before becoming involved in the details of circuit analysis, we need to take a broad look at engineering design, specifically the design of electric circuits. The purpose of this overview is to provide you with a perspective on where circuit analysis fits within the whole of circuit design. Even though this book focuses on circuit analysis, we try to provide opportunities for circuit design where appropriate.

All engineering designs begin with a need, as shown in Fig. 1.4. This need may come from the desire to improve on an existing design, or it may be something brand-new. A careful assessment of the need results in design specifications, which are measurable characteristics of a proposed design. Once a design is proposed, the design specifications allow us to assess whether or not the design actually meets the need.

A concept for the design comes next. The concept derives from a complete understanding of the design specifications coupled with an insight into

the need, which comes from education and experience. The concept may be realized as a sketch, as a written description, or in some other form. Often the next step is to translate the concept into a mathematical model. A commonly used mathematical model for electrical systems is a **circuit model**.

The elements that comprise the circuit model are called **ideal circuit components**. An ideal circuit component is a mathematical model of an actual electrical component, like a battery or a light bulb. It is important for the ideal circuit component used in a circuit model to represent the behavior of the actual electrical component to an acceptable degree of accuracy. The tools of **circuit analysis**, the focus of this book, are then applied to the circuit. Circuit analysis is based on mathematical techniques and is used to predict the behavior of the circuit model and its ideal circuit components. A comparison between the desired behavior, from the design specifications, and the predicted behavior, from circuit analysis, may lead to refinements in the circuit model and its ideal circuit elements. Once the desired and predicted behavior are in agreement, a physical prototype can be constructed.

The **physical prototype** is an actual electrical system, constructed from actual electrical components. Measurement techniques are used to determine the actual, quantitative behavior of the physical system. This actual behavior is compared with the desired behavior from the design specifications and the predicted behavior from circuit analysis. The comparisons may result in refinements to the physical prototype, the circuit model, or both. Eventually, this iterative process, in which models, components, and systems are continually refined, may produce a design that accurately matches the design specifications and thus meets the need.

From this description, it is clear that circuit analysis plays a very important role in the design process. Because circuit analysis is applied to circuit models, practicing engineers try to use mature circuit models so that the resulting designs will meet the design specifications in the first iteration. In this book, we use models that have been tested for between 20 and 100 years; you can assume that they are mature. The ability to model actual electrical systems with ideal circuit elements makes circuit theory extremely useful to engineers.

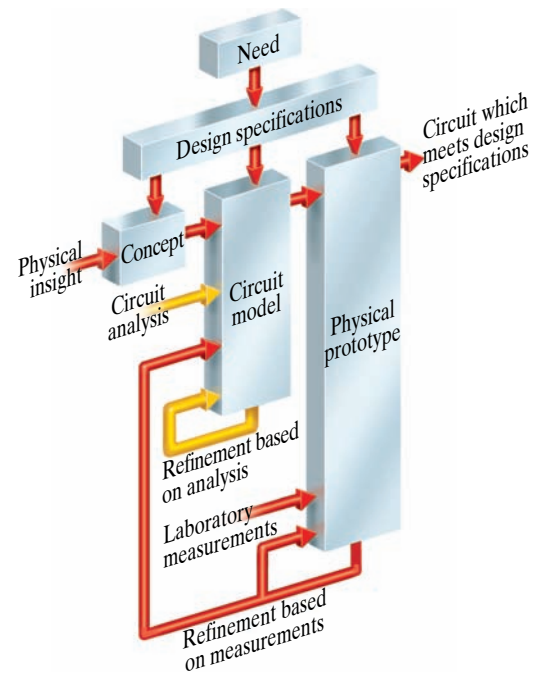
Saying that the interconnection of ideal circuit elements can be used to quantitatively predict the behavior of a system implies that we can describe the interconnection with mathematical equations. For the mathematical equations to be useful, we must write them in terms of measurable quantities. In the case of circuits, these quantities are voltage and current, which we discuss in Section 1.4. The study of circuit analysis involves understanding the behavior of each ideal circuit element in terms of its voltage and current and understanding the constraints imposed on the voltage and current as a result of interconnecting the ideal elements.

## 1.4 Voltage and Current

The concept of electric charge is the basis for describing all electrical phenomena. Let's review some important characteristics of electric charge.

- The charge is bipolar, meaning that electrical effects are described in terms of positive and negative charges.
- The electric charge exists in discrete quantities, which are integral multiples of the electronic charge,  $1.6022 \times 10^{-19}$  C.
- Electrical effects are attributed to both the separation of charge and charges in motion.

In circuit theory, the separation of charge creates an electric force (voltage), and the motion of charge creates an electric fluid (current).



**Figure 1.4** ▲ A conceptual model for electrical engineering design.

The concepts of voltage and current are useful from an engineering point of view because they can be expressed quantitatively. Whenever positive and negative charges are separated, energy is expended. **Voltage** is the energy per unit charge created by the separation. We express this ratio in differential form as

**Definition of voltage** ►

$$v = \frac{dw}{dq}, \quad (1.1)$$

where

$$\begin{aligned} v &= \text{the voltage in volts,} \\ w &= \text{the energy in joules,} \\ q &= \text{the charge in coulombs.} \end{aligned}$$

The electrical effects caused by charges in motion depend on the rate of charge flow. The rate of charge flow is known as the **electric current**, which is expressed as

**Definition of current** ►

$$i = \frac{dq}{dt}, \quad (1.2)$$

where

$$\begin{aligned} i &= \text{the current in amperes,} \\ q &= \text{the charge in coulombs,} \\ t &= \text{the time in seconds.} \end{aligned}$$

Equations 1.1 and 1.2 are definitions for the magnitude of voltage and current, respectively. The bipolar nature of electric charge requires that we assign polarity references to these variables. We will do so in Section 1.5.

Although current is made up of discrete, moving electrons, we do not need to consider them individually because of the enormous number of them. Rather, we can think of electrons and their corresponding charge as one smoothly flowing entity. Thus,  $i$  is treated as a continuous variable.

One advantage of using circuit models is that we can model a component strictly in terms of the voltage and current at its terminals. Thus two physically different components could have the same relationship between the terminal voltage and terminal current. If they do, for purposes of circuit analysis, they are identical. Once we know how a component behaves at its terminals, we can analyze its behavior in a circuit. However, when developing circuit models, we are interested in a component's internal behavior. We might want to know, for example, whether charge conduction is taking place because of free electrons moving through the crystal lattice structure of a metal or whether it is because of electrons moving within the covalent bonds of a semiconductor material. However, these concerns are beyond the realm of circuit theory. In this book we use circuit models that have already been developed; we do not discuss how component models are developed.

## 1.5 The Ideal Basic Circuit Element

An **ideal basic circuit element** has three attributes: (1) it has only two terminals, which are points of connection to other circuit components; (2) it is described mathematically in terms of current and/or voltage; and (3) it cannot be subdivided into other elements. We use the word *ideal* to imply

that a basic circuit element does not exist as a realizable physical component. However, as we discussed in Section 1.3, ideal elements can be connected in order to model actual devices and systems. We use the word *basic* to imply that the circuit element cannot be further reduced or subdivided into other elements. Thus the basic circuit elements form the building blocks for constructing circuit models, but they themselves cannot be modeled with any other type of element.

Figure 1.5 is a representation of an ideal basic circuit element. The box is blank because we are making no commitment at this time as to the type of circuit element it is. In Fig. 1.5, the voltage across the terminals of the box is denoted by  $v$ , and the current in the circuit element is denoted by  $i$ . The polarity reference for the voltage is indicated by the plus and minus signs, and the reference direction for the current is shown by the arrow placed alongside the current. The interpretation of these references given positive or negative numerical values of  $v$  and  $i$  is summarized in Table 1.4. Note that algebraically the notion of positive charge flowing in one direction is equivalent to the notion of negative charge flowing in the opposite direction.

The assignments of the reference polarity for voltage and the reference direction for current are entirely arbitrary. However, once you have assigned the references, you must write all subsequent equations to agree with the chosen references. The most widely used sign convention applied to these references is called the **passive sign convention**, which we use throughout this book. The passive sign convention can be stated as follows:

Whenever the reference direction for the current in an element is in the direction of the reference voltage drop across the element (as in Fig. 1.5), use a positive sign in any expression that relates the voltage to the current. Otherwise, use a negative sign.

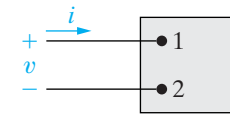
◀ **Passive sign convention**

We apply this sign convention in all the analyses that follow. Our purpose for introducing it even before we have introduced the different types of basic circuit elements is to impress on you the fact that the selection of polarity references along with the adoption of the passive sign convention is *not* a function of the basic elements nor the type of interconnections made with the basic elements. We present the application and interpretation of the passive sign convention in power calculations in Section 1.6.

Example 1.2 illustrates one use of the equation defining current.

**TABLE 1.4** Interpretation of Reference Directions in Fig. 1.5

Positive Value	Negative Value
$v$ voltage drop from terminal 1 to terminal 2 <i>or</i> voltage rise from terminal 2 to terminal 1	voltage rise from terminal 1 to terminal 2 <i>or</i> voltage drop from terminal 2 to terminal 1
$i$ positive charge flowing from terminal 1 to terminal 2 <i>or</i> negative charge flowing from terminal 2 to terminal 1	positive charge flowing from terminal 2 to terminal 1 <i>or</i> negative charge flowing from terminal 1 to terminal 2



**Figure 1.5** ▲ An ideal basic circuit element.

**Example 1.2** Relating Current and Charge

No charge exists at the upper terminal of the element in Fig. 1.5 for  $t < 0$ . At  $t = 0$ , a 5 A current begins to flow into the upper terminal.

- Derive the expression for the charge accumulating at the upper terminal of the element for  $t > 0$ .
- If the current is stopped after 10 seconds, how much charge has accumulated at the upper terminal?

**Solution**

- From the definition of current given in Eq. 1.2, the expression for charge accumulation due to current flow is

$$q(t) = \int_0^t i(x) dx.$$

Therefore,

$$q(t) = \int_0^t 5 dx = 5x \Big|_0^t = 5t - 5(0) = 5t \text{ C for } t > 0.$$

- The total charge that accumulates at the upper terminal in 10 seconds due to a 5 A current is  $q(10) = 5(10) = 50 \text{ C}$ .

**ASSESSMENT PROBLEMS**

**Objective 2—Know and be able to use the definitions of voltage and current**

- 1.3** The current at the terminals of the element in Fig. 1.5 is

$$i = 0, \quad t < 0;$$

$$i = 20e^{-5000t} \text{ A}, \quad t \geq 0.$$

Calculate the total charge (in microcoulombs) entering the element at its upper terminal.

**Answer:** 4000  $\mu\text{C}$ .

*NOTE: Also try Chapter Problem 1.8.*

- 1.4** The expression for the charge entering the upper terminal of Fig. 1.5 is

$$q = \frac{1}{\alpha^2} - \left( \frac{t}{\alpha} + \frac{1}{\alpha^2} \right) e^{-\alpha t} \text{ C}.$$

Find the maximum value of the current entering the terminal if  $\alpha = 0.03679 \text{ s}^{-1}$ .

**Answer:** 10 A.

## 1.6 Power and Energy

Power and energy calculations also are important in circuit analysis. One reason is that although voltage and current are useful variables in the analysis and design of electrically based systems, the useful output of the system often is nonelectrical, and this output is conveniently expressed in terms of power or energy. Another reason is that all practical devices have limitations on the amount of power that they can handle. In the design process, therefore, voltage and current calculations by themselves are not sufficient.

We now relate power and energy to voltage and current and at the same time use the power calculation to illustrate the passive sign convention. Recall from basic physics that power is the time rate of expending or

absorbing energy. (A water pump rated 75 kW can deliver more liters per second than one rated 7.5 kW.) Mathematically, energy per unit time is expressed in the form of a derivative, or

$$p = \frac{dw}{dt}, \quad (1.3) \quad \blacktriangleleft \text{Definition of power}$$

where

$$\begin{aligned} p &= \text{the power in watts,} \\ w &= \text{the energy in joules,} \\ i &= \text{the time in seconds.} \end{aligned}$$

Thus 1 W is equivalent to 1 J/s.

The power associated with the flow of charge follows directly from the definition of voltage and current in Eqs. 1.1 and 1.2, or

$$p = \frac{dw}{dt} = \left( \frac{dw}{dq} \right) \left( \frac{dq}{dt} \right),$$

so

$$p = vi \quad (1.4) \quad \blacktriangleleft \text{Power equation}$$

where

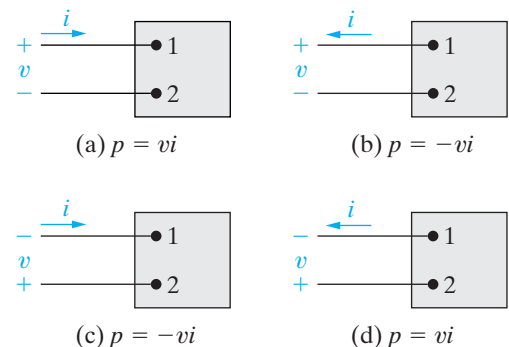
$$\begin{aligned} p &= \text{the power in watts,} \\ v &= \text{the voltage in volts,} \\ i &= \text{the current in amperes.} \end{aligned}$$

Equation 1.4 shows that the **power** associated with a basic circuit element is simply the product of the current in the element and the voltage across the element. Therefore, power is a quantity associated with a pair of terminals, and we have to be able to tell from our calculation whether power is being delivered to the pair of terminals or extracted from it. This information comes from the correct application and interpretation of the passive sign convention.

If we use the passive sign convention, Eq. 1.4 is correct if the reference direction for the current is in the direction of the reference voltage drop across the terminals. Otherwise, Eq. 1.4 must be written with a minus sign. In other words, if the current reference is in the direction of a reference voltage rise across the terminals, the expression for the power is

$$p = -vi \quad (1.5)$$

The algebraic sign of power is based on charge movement through voltage drops and rises. As positive charges move through a drop in voltage, they lose energy, and as they move through a rise in voltage, they gain energy. Figure 1.6 summarizes the relationship between the polarity references for voltage and current and the expression for power.



**Figure 1.6** ▲ Polarity references and the expression for power.



We can now state the rule for interpreting the algebraic sign of power:

**Interpreting algebraic sign of power** ▶

If the power is positive (that is, if  $p > 0$ ), power is being delivered to the circuit inside the box. If the power is negative (that is, if  $p < 0$ ), power is being extracted from the circuit inside the box.

For example, suppose that we have selected the polarity references shown in Fig. 1.6(b). Assume further that our calculations for the current and voltage yield the following numerical results:

$$i = 4 \text{ A} \quad \text{and} \quad v = -10 \text{ V.}$$

Then the power associated with the terminal pair 1,2 is

$$p = -(-10)(4) = 40 \text{ W.}$$

Thus the circuit inside the box is absorbing 40 W.

To take this analysis one step further, assume that a colleague is solving the same problem but has chosen the reference polarities shown in Fig. 1.6(c). The resulting numerical values are

$$i = -4 \text{ A}, \quad v = 10 \text{ V}, \quad \text{and} \quad p = 40 \text{ W.}$$

Note that interpreting these results in terms of this reference system gives the same conclusions that we previously obtained—namely, that the circuit inside the box is absorbing 40 W. In fact, any of the reference systems in Fig. 1.6 yields this same result.

Example 1.3 illustrates the relationship between voltage, current, power, and energy for an ideal basic circuit element and the use of the passive sign convention.

**Example 1.3** Relating Voltage, Current, Power, and Energy

Assume that the voltage at the terminals of the element in Fig. 1.5, whose current was defined in Assessment Problem 1.3, is

$$\begin{aligned} v &= 0 & t < 0; \\ v &= 10e^{-5000t} \text{ kV}, & t \geq 0. \end{aligned}$$

- a) Calculate the power supplied to the element at 1 ms.
- b) Calculate the total energy (in joules) delivered to the circuit element.

**Solution**

- a) Since the current is entering the + terminal of the voltage drop defined for the element in Fig. 1.5, we use a “+” sign in the power equation.

$$\begin{aligned} p &= vi = (10,000e^{-5000t})(20e^{-5000t}) = 200,000e^{-10,000t} \text{ W.} \\ p(0.001) &= 200,000e^{-10,000(0.001)} = 200,000e^{-10} \\ &= 200,000(45.4 \times 10^{-6}) = 0.908 \text{ W.} \end{aligned}$$

- b) From the definition of power given in Eq. 1.3, the expression for energy is

$$w(t) = \int_0^t p(x) dx$$

To find the total energy delivered, integrate the expression for power from zero to infinity. Therefore,

$$\begin{aligned} w_{\text{total}} &= \int_0^{\infty} 200,000e^{-10,000x} dx = \left. \frac{200,000e^{-10,000x}}{-10,000} \right|_0^{\infty} \\ &= -20e^{-\infty} - (-20e^0) = 0 + 20 = 20 \text{ J.} \end{aligned}$$

Thus, the total energy supplied to the circuit element is 20 J.

## ASSESSMENT PROBLEMS

**Objective 3—Know and use the definitions of power and energy; Objective 4—Be able to use the passive sign convention**

- 1.5** Assume that a 20 V voltage drop occurs across an element from terminal 2 to terminal 1 and that a current of 4 A enters terminal 2.
- Specify the values of  $v$  and  $i$  for the polarity references shown in Fig. 1.6(a)–(d).
  - State whether the circuit inside the box is absorbing or delivering power.
  - How much power is the circuit absorbing?

**Answer:** (a) Circuit 1.6(a):  $v = -20$  V,  $i = -4$  A;  
 circuit 1.6(b):  $v = -20$  V,  $i = 4$  A;  
 circuit 1.6(c):  $v = 20$  V,  $i = -4$  A;  
 circuit 1.6(d):  $v = 20$  V,  $i = 4$  A;  
 (b) absorbing;  
 (c) 80 W.

- 1.6** The voltage and current at the terminals of the circuit element in Fig 1.5 are zero for  $t < 0$ . For  $t \geq 0$ , they are

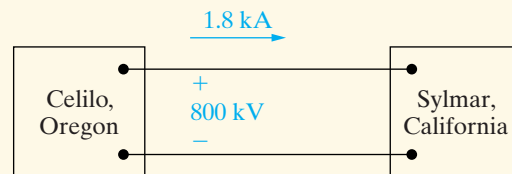
$$v = 80,000te^{-500t} \text{ V}, \quad t \geq 0;$$

$$i = 15te^{-500t} \text{ A}, \quad t \geq 0.$$

- Find the time when the power delivered to the circuit element is maximum.
- Find the maximum value of power.
- Find the total energy delivered to the circuit element.

**Answer:** (a) 2 ms; (b) 649.6 mW; (c) 2.4 mJ.

- 1.7** A high-voltage direct-current (dc) transmission line between Celilo, Oregon and Sylmar, California is operating at 800 kV and carrying 1800 A, as shown. Calculate the power (in megawatts) at the Oregon end of the line and state the direction of power flow.



**Answer:** 1440 MW, Celilo to Sylmar

*NOTE: Also try Chapter Problems 1.12, 1.19, and 1.24.*

## Practical Perspective

### Balancing Power

A model of the circuitry that distributes power to a typical home is shown in Fig. 1.7 with voltage polarities and current directions defined for all of the circuit components. The results of circuit analysis give the values for all of these voltages and currents, which are summarized in Table 1.4. To determine whether or not the values given are correct, calculate the power associated with each component. Use the passive sign convention in the power calculations, as shown below.

$$p_a = v_a i_a = (120)(-10) = -1200 \text{ W} \quad p_b = -v_b i_b = -(120)(9) = -1080 \text{ W}$$

$$p_c = v_c i_c = (10)(10) = 100 \text{ W} \quad p_d = -v_d i_d = -(10)(1) = -10 \text{ W}$$

$$p_e = v_e i_e = (-10)(-9) = 90 \text{ W} \quad p_f = -v_f i_f = -(-100)(5) = 500 \text{ W}$$

$$p_g = v_g i_g = (120)(4) = 480 \text{ W} \quad p_h = v_h i_h = (-220)(-5) = 1100 \text{ W}$$

The power calculations show that components a, b, and d are supplying power, since the power values are negative, while components c, e, f, g, and h are absorbing power. Now check to see if the power balances by finding the total power supplied and the total power absorbed.

$$P_{\text{supplied}} = p_a + p_b + p_d = -1200 - 1080 - 10 = -2290 \text{ W}$$

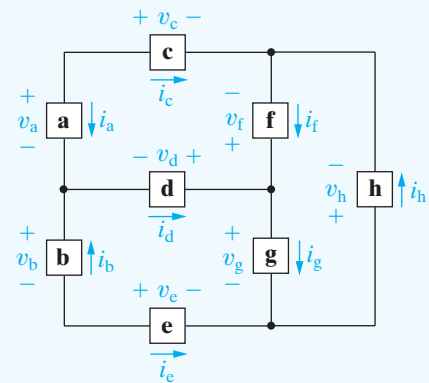
$$P_{\text{absorbed}} = p_c + p_e + p_f + p_g + p_h \\ = 100 + 90 + 500 + 480 + 1100 = 2270 \text{ W}$$

$$P_{\text{supplied}} + P_{\text{absorbed}} = -2290 + 2270 = -20 \text{ W}$$

Something is wrong—if the values for voltage and current in this circuit are correct, the total power should be zero! There is an error in the data and we can find it from the calculated powers if the error exists in the sign of a single component. Note that if we divide the total power by 2, we get  $-10 \text{ W}$ , which is the power calculated for component d. If the power for component d was  $+10 \text{ W}$ , the total power would be 0. Circuit analysis techniques from upcoming chapters can be used to show that the current through component d should be  $-1 \text{ A}$ , not  $+1 \text{ A}$  given in Table 1.4.

**TABLE 1.4** Voltage and current values for the circuit in Fig. 1.7.

Component	$v(\text{V})$	$i(\text{A})$
a	120	-10
b	120	9
c	10	10
d	10	1
e	-10	-9
f	-100	5
g	120	4
h	-220	-5



**Figure 1.7** ▲ Circuit model for power distribution in a home, with voltages and currents defined.

*Note: Assess your understanding of the Practical Perspective by trying Chapter Problems 1.34 and 1.35.*

## Summary

- The International System of Units (SI) enables engineers to communicate in a meaningful way about quantitative results. Table 1.1 summarizes the base SI units; Table 1.2 presents some useful derived SI units. (See pages 8 and 9.)
- Circuit analysis is based on the variables of voltage and current. (See page 11.)
- **Voltage** is the energy per unit charge created by charge separation and has the SI unit of volt ( $v = dw/dq$ ). (See page 12.)
- **Current** is the rate of charge flow and has the SI unit of ampere ( $i = dq/dt$ ). (See page 12.)
- The **ideal basic circuit element** is a two-terminal component that cannot be subdivided; it can be described mathematically in terms of its terminal voltage and current. (See page 12.)
- The **passive sign convention** uses a positive sign in the expression that relates the voltage and current at the terminals of an element when the reference direction for the current through the element is in the direction of the reference voltage drop across the element. (See page 13.)
- **Power** is energy per unit of time and is equal to the product of the terminal voltage and current; it has the SI unit of watt ( $p = dw/dt = vi$ ). (See page 15.)
- The algebraic sign of power is interpreted as follows:
  - If  $p > 0$ , power is being delivered to the circuit or circuit component.
  - If  $p < 0$ , power is being extracted from the circuit or circuit component. (See page 16.)

## Problems

### Section 1.2

- 1.1** There are approximately 260 million passenger vehicles registered in the United States. Assume that the battery in the average vehicle stores 540 watt-hours (Wh) of energy. Estimate (in gigawatt-hours) the total energy stored in U.S. passenger vehicles.
- 1.2** A hand-held video player displays  $480 \times 320$  picture elements (pixels) in each frame of the video. Each pixel requires 2 bytes of memory. Videos are displayed at a rate of 30 frames per second. How many hours of video will fit in a 32 gigabyte memory?
- 1.3** The 16 giga-byte ( $\text{GB} = 2^{30}$  bytes) flash memory chip for an MP3 player is 11 mm by 15 mm by 1 mm. This memory chip holds 20,000 photos.
- How many photos fit into a cube whose sides are 1 mm?
  - How many bytes of memory are stored in a cube whose sides are  $200 \mu\text{m}$ ?
- 1.4** The line described in Assessment Problem 1.7 is 845 mi in length. The line contains four conductors, each weighing 2526 lb per 1000 ft. How many kilograms of conductor are in the line?
- 1.5** One liter (L) of paint covers approximately  $10 \text{ m}^2$  of wall. How thick is the layer before it dries? (*Hint:*  $1 \text{ L} = 1 \times 10^6 \text{ mm}^3$ .)
- 1.6** Some species of bamboo can grow 250 mm/day. Assume individual cells in the plant are  $10 \mu\text{m}$  long.
- How long, on average, does it take a bamboo stalk to grow 1 cell length?
  - How many cell lengths are added in one week, on average?

### Section 1.4

- 1.7** There is no charge at the upper terminal of the element in Fig. 1.5 for  $t < 0$ . At  $t = 0$  a current of  $125e^{-2500t}$  mA enters the upper terminal.
- Derive the expression for the charge that accumulates at the upper terminal for  $t > 0$ .
  - Find the total charge that accumulates at the upper terminal.
  - If the current is stopped at  $t = 0.5$  ms, how much charge has accumulated at the upper terminal?

- 1.8** The current entering the upper terminal of Fig. 1.5 is

$$i = 20 \cos 5000t \text{ A.}$$

Assume the charge at the upper terminal is zero at the instant the current is passing through its maximum value. Find the expression for  $q(t)$ .

- 1.9** The current at the terminals of the element in Fig. 1.5 is

$$\begin{aligned} i &= 0, & t < 0; \\ i &= 40te^{-500t} \text{ A}, & t \geq 0. \end{aligned}$$

- Find the expression for the charge accumulating at the upper terminal.
- Find the charge that has accumulated at  $t = 1$  ms.

- 1.10** In electronic circuits it is not unusual to encounter currents in the microampere range. Assume a  $35 \mu\text{A}$  current, due to the flow of electrons. What is the average number of electrons per second that flow past a fixed reference cross section that is perpendicular to the direction of flow?

- 1.11** How much energy is imparted to an electron as it flows through a 6 V battery from the positive to the negative terminal? Express your answer in attojoules.

### Sections 1.5–1.6

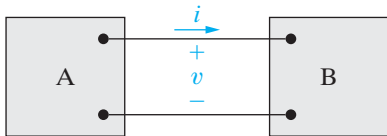
- 1.12** The references for the voltage and current at the terminal of a circuit element are as shown in Fig. 1.6(d). The numerical values for  $v$  and  $i$  are 40 V and  $-10$  A.
- Calculate the power at the terminals and state whether the power is being absorbed or delivered by the element in the box.
  - Given that the current is due to electron flow, state whether the electrons are entering or leaving terminal 2.
  - Do the electrons gain or lose energy as they pass through the element in the box?

- 1.13** Repeat Problem 1.12 with a voltage of  $-60$  V.

- 1.14** Two electric circuits, represented by boxes A and B, are connected as shown in Fig. P1.14. The reference direction for the current  $i$  in the interconnection and the reference polarity for the voltage  $v$  across the interconnection are as shown in the figure. For each of the following sets of numerical values, calculate the power in the interconnection and state whether the power is flowing from A to B or vice versa.

- a)  $i = 6 \text{ A}$ ,  $v = 30 \text{ V}$   
 b)  $i = -8 \text{ A}$ ,  $v = -20 \text{ V}$   
 c)  $i = 4 \text{ A}$ ,  $v = -60 \text{ V}$   
 d)  $i = -9 \text{ A}$ ,  $v = 40 \text{ V}$

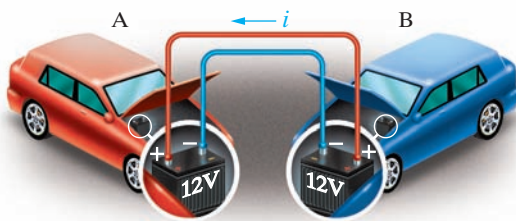
Figure P1.14



**1.15** When a car has a dead battery, it can often be started by connecting the battery from another car across its terminals. The positive terminals are connected together as are the negative terminals. The connection is illustrated in Fig. P1.15. Assume the current  $i$  in Fig. P1.15 is measured and found to be 30 A.

- a) Which car has the dead battery?  
 b) If this connection is maintained for 1 min, how much energy is transferred to the dead battery?

Figure P1.15



**1.16** The manufacturer of a 1.5 V D flashlight battery says that the battery will deliver 9 mA for 40 continuous hours. During that time the voltage will drop from 1.5 V to 1.0 V. Assume the drop in voltage is linear with time. How much energy does the battery deliver in this 40 h interval?

**1.17** One 12 V battery supplies 100 mA to a boom box. How much energy does the battery supply in 4 h?

**1.18** The voltage and current at the terminals of the circuit element in Fig. 1.5 are zero for  $t < 0$ . For  $t \geq 0$  they are

$$v = 15e^{-250t} \text{ V},$$

$$i = 40e^{-250t} \text{ mA}.$$

- a) Calculate the power supplied to the element at 10 ms.  
 b) Calculate the total energy delivered to the circuit element.

**1.19** The voltage and current at the terminals of the circuit element in Fig. 1.5 are zero for  $t < 0$ . For  $t \geq 0$  they are

PSPICE  
MULTISIM

$$v = 75 - 75e^{-1000t} \text{ V},$$

$$i = 50e^{-1000t} \text{ mA}.$$

- a) Find the maximum value of the power delivered to the circuit.  
 b) Find the total energy delivered to the element.

**1.20** The voltage and current at the terminals of the circuit element in Fig. 1.5 are zero for  $t < 0$ . For  $t \geq 0$  they are

$$v = 50e^{-1600t} - 50e^{-400t} \text{ V},$$

$$i = 5e^{-1600t} - 5e^{-400t} \text{ mA}.$$

- a) Find the power at  $t = 625 \mu\text{s}$ .  
 b) How much energy is delivered to the circuit element between 0 and  $625 \mu\text{s}$ ?  
 c) Find the total energy delivered to the element.

**1.21** The voltage and current at the terminals of the circuit element in Fig. 1.5 are zero for  $t < 0$ . For  $t \geq 0$  they are

PSPICE  
MULTISIM

$$v = (1500t + 1)e^{-750t} \text{ V}, \quad t \geq 0;$$

$$i = 40e^{-750t} \text{ mA}, \quad t \geq 0.$$

- a) Find the time when the power delivered to the circuit element is maximum.  
 b) Find the maximum value of  $p$  in milliwatts.  
 c) Find the total energy delivered to the circuit element in microjoules.

**1.22** The voltage and current at the terminals of the circuit element in Fig. 1.5 are zero for  $t < 0$ . For  $t \geq 0$  they are

PSPICE  
MULTISIM

$$v = (3200t + 4)e^{-1000t} \text{ V},$$

$$i = (128t + 0.16)e^{-1000t} \text{ A}.$$

- a) At what instant of time is maximum power delivered to the element?  
 b) Find the maximum power in watts.  
 c) Find the total energy delivered to the element in microjoules.

**1.23** The voltage and current at the terminals of the circuit element in Fig. 1.5 are zero for  $t < 0$  and  $t > 40 \text{ s}$ . In the interval between 0 and 40 s the expressions are

PSPICE  
MULTISIM

$$v = t(1 - 0.025t) \text{ V}, \quad 0 < t < 40 \text{ s};$$

$$i = 4 - 0.2t \text{ A}, \quad 0 < t < 40 \text{ s}.$$

- a) At what instant of time is the power being delivered to the circuit element maximum?  
 b) What is the power at the time found in part (a)?  
 c) At what instant of time is the power being extracted from the circuit element maximum?  
 d) What is the power at the time found in part (c)?  
 e) Calculate the net energy delivered to the circuit at 0, 10, 20, 30 and 40 s.

- 1.24** The voltage and current at the terminals of the circuit element in Fig. 1.5 are zero for  $t < 0$ . For  $t \geq 0$  they are

$$v = 400e^{-100t} \sin 200t \text{ V,}$$

$$i = 5e^{-100t} \sin 200t \text{ A.}$$

- Find the power absorbed by the element at  $t = 10$  ms.
- Find the total energy absorbed by the element.

- 1.25** The voltage and current at the terminals of the element in Fig. 1.5 are

PSPICE  
MULTISIM

$$v = 250 \cos 800\pi t \text{ V, } i = 8 \sin 800\pi t \text{ A.}$$

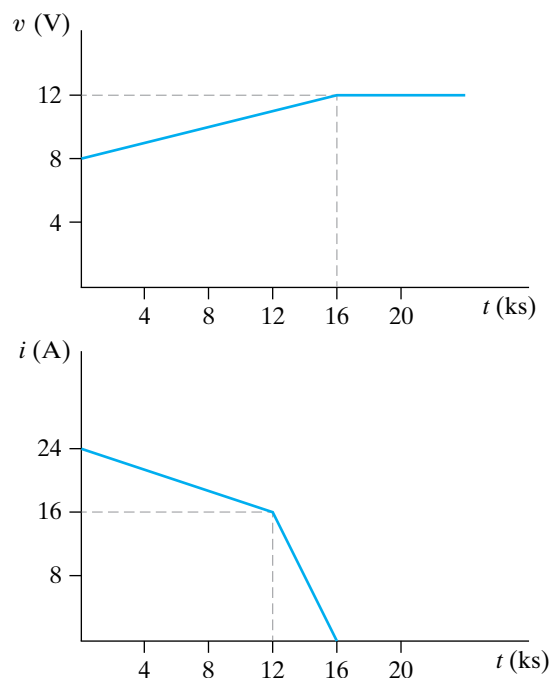
- Find the maximum value of the power being delivered to the element.
- Find the maximum value of the power being extracted from the element.
- Find the average value of  $p$  in the interval  $0 \leq t \leq 2.5$  ms.
- Find the average value of  $p$  in the interval  $0 \leq t \leq 15.625$  ms.

- 1.26** The voltage and current at the terminals of an automobile battery during a charge cycle are shown in Fig. P1.26.

PSPICE  
MULTISIM

- Calculate the total charge transferred to the battery.
- Calculate the total energy transferred to the battery.
- Find the total energy delivered to the element.

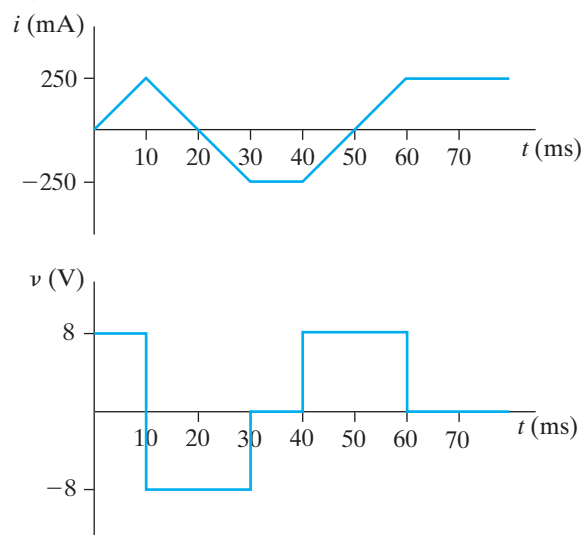
Figure P1.26



- 1.27** The voltage and current at the terminals of the circuit element in Fig. 1.5 are shown in Fig. P1.27.

- Sketch the power versus  $t$  plot for  $0 \leq t \leq 80$  ms.
- Calculate the energy delivered to the circuit element at  $t = 10, 30,$  and  $80$  ms.

Figure P1.27



- 1.28** An industrial battery is charged over a period of several hours at a constant voltage of 120 V. Initially, the current is 10 mA and increases linearly to 15 mA in 10 ks. From 10 ks to 20 ks, the current is constant at 15 mA. From 20 ks to 30 ks the current decreases linearly to 10 mA. At 30 ks the power is disconnected from the battery.

- Sketch the current from  $t = 0$  to  $t = 30$  ks.
- Sketch the power delivered to the battery from  $t = 0$  to  $t = 30$  ks.
- Using the sketch of the power, find the total energy delivered to the battery.

- 1.29** The numerical values for the currents and voltages in the circuit in Fig. P1.29 are given in Table P1.29. Find the total power developed in the circuit.

Figure P1.29

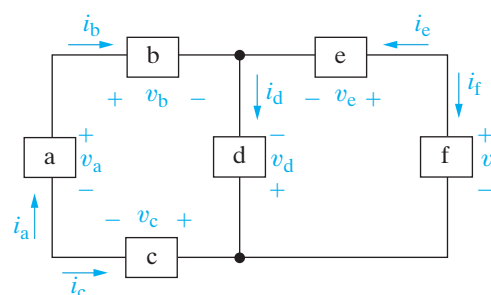


TABLE P1.29

Element	Voltage (V)	Current (mA)
a	40	-4
b	-24	-4
c	-16	4
d	-80	-1.5
e	40	2.5
f	120	-2.5

1.30 The numerical values of the voltages and currents in the interconnection seen in Fig. P1.30 are given in Table P1.30. Does the interconnection satisfy the power check?

Figure P1.30

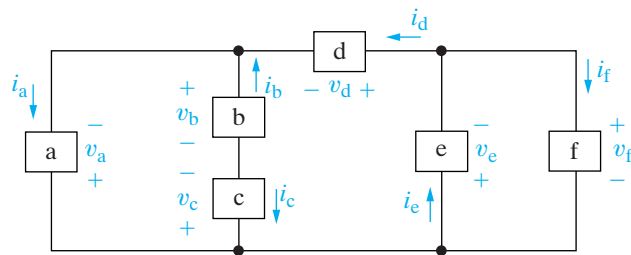


TABLE P1.30

Element	Voltage (kV)	Current ( $\mu$ A)
a	-3	-250
b	4	-400
c	1	400
d	1	150
e	-4	200
f	4	50

1.31 Assume you are an engineer in charge of a project and one of your subordinate engineers reports that the interconnection in Fig. P1.31 does not pass the power check. The data for the interconnection are given in Table P1.31.

- Is the subordinate correct? Explain your answer.
- If the subordinate is correct, can you find the error in the data?

Figure P1.31

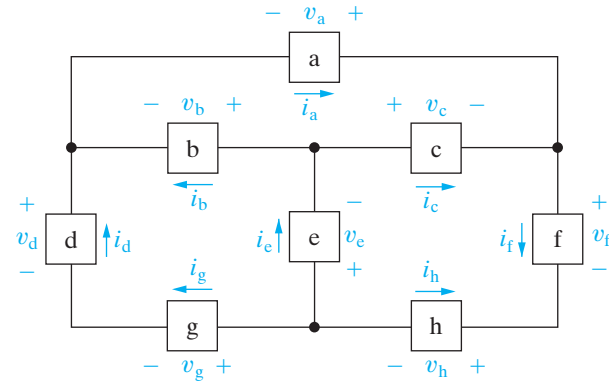


TABLE P1.31

Element	Voltage (V)	Current (A)
a	46.16	6.0
b	14.16	4.72
c	-32.0	-6.4
d	22.0	1.28
e	-33.6	-1.68
f	66.0	0.4
g	2.56	1.28
h	-0.4	0.4

1.32 The voltage and power values for each of the elements shown in Fig. P1.32 are given in Table P1.32.

- Show that the interconnection of the elements satisfies the power check.
- Find the value of the current through each of the elements using the values of power and voltage and the current directions shown in the figure.

Figure P1.32

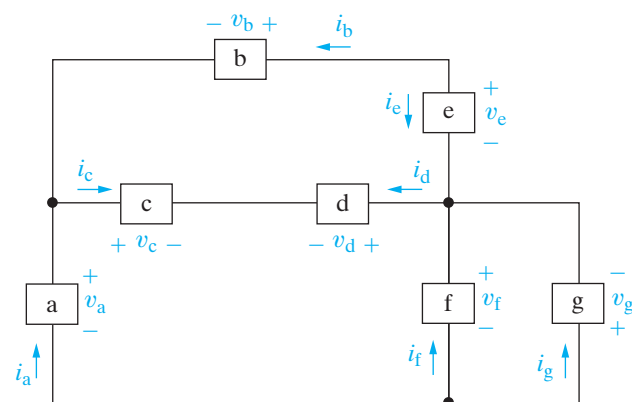




TABLE P1.32

Element	Power (kW)	Voltage (V)
a	0.6 supplied	400
b	0.05 supplied	-100
c	0.4 absorbed	200
d	0.6 supplied	300
e	0.1 absorbed	-200
f	2.0 absorbed	500
g	1.25 supplied	-500

**1.33** The current and power for each of the interconnected elements in Fig. P1.33 is measured. The values are listed in Table P1.33.

- Show that the interconnection satisfies the power check.
- Identify the elements that absorb power.
- Find the voltage for each of the elements in the interconnection, using the values of power and current and the voltage polarities shown in the figure.

Figure P1.33

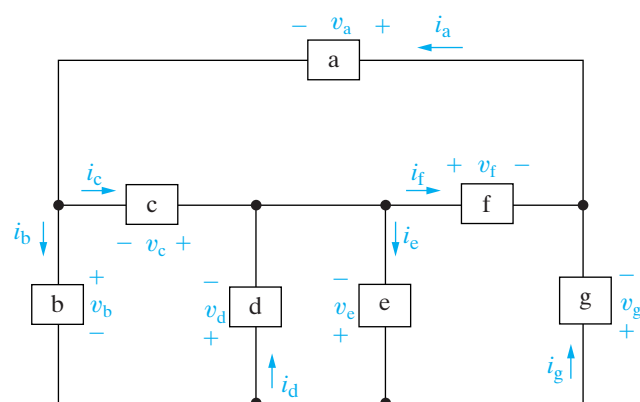


TABLE P1.33

Element	Power (mW)	Current (mA)
a	175	25
b	375	75
c	150	-50
d	-320	40
e	160	20
f	120	-30
g	-660	55

**1.34** Show that the power balances for the circuit shown in Fig. 1.7, using the voltage and current values given in Table 1.4, with the value of the current for component d changed to  $-1$  A.

**1.35** Suppose there is no power lost in the wires used to distribute power in a typical home.

- Create a new model for the power distribution circuit by modifying the circuit shown in Fig 1.7. Use the same names, voltage polarities, and current directions for the components that remain in this modified model.

- The following voltages and currents are calculated for the components:

$$\begin{aligned} v_a &= 120 \text{ V} & i_a &= -10 \text{ A} \\ v_b &= 120 \text{ V} & i_b &= 10 \text{ A} \\ v_f &= -120 \text{ V} & i_f &= 3 \text{ A} \\ v_g &= 120 \text{ V} \\ v_h &= -240 \text{ V} & i_h &= -7 \text{ A} \end{aligned}$$

If the power in this modified model balances, what is the value of the current in component g?

## CHAPTER CONTENTS

- 2.1 Voltage and Current Sources *p. 26*
- 2.2 Electrical Resistance (Ohm's Law) *p. 30*
- 2.3 Construction of a Circuit Model *p. 34*
- 2.4 Kirchhoff's Laws *p. 37*
- 2.5 Analysis of a Circuit Containing Dependent Sources *p. 42*

## ✓ CHAPTER OBJECTIVES

- 1 Understand the symbols for and the behavior of the following ideal basic circuit elements: independent voltage and current sources, dependent voltage and current sources, and resistors.
- 2 Be able to state Ohm's law, Kirchhoff's current law, and Kirchhoff's voltage law, and be able to use these laws to analyze simple circuits.
- 3 Know how to calculate the power for each element in a simple circuit and be able to determine whether or not the power balances for the whole circuit.



## Circuit Elements

**There are five ideal basic circuit elements:** voltage sources, current sources, resistors, inductors, and capacitors. In this chapter we discuss the characteristics of voltage sources, current sources, and resistors. Although this may seem like a small number of elements with which to begin analyzing circuits, many practical systems can be modeled with just sources and resistors. They are also a useful starting point because of their relative simplicity; the mathematical relationships between voltage and current in sources and resistors are algebraic. Thus you will be able to begin learning the basic techniques of circuit analysis with only algebraic manipulations.

We will postpone introducing inductors and capacitors until Chapter 6, because their use requires that you solve integral and differential equations. However, the basic analytical techniques for solving circuits with inductors and capacitors are the same as those introduced in this chapter. So, by the time you need to begin manipulating more difficult equations, you should be very familiar with the methods of writing them.

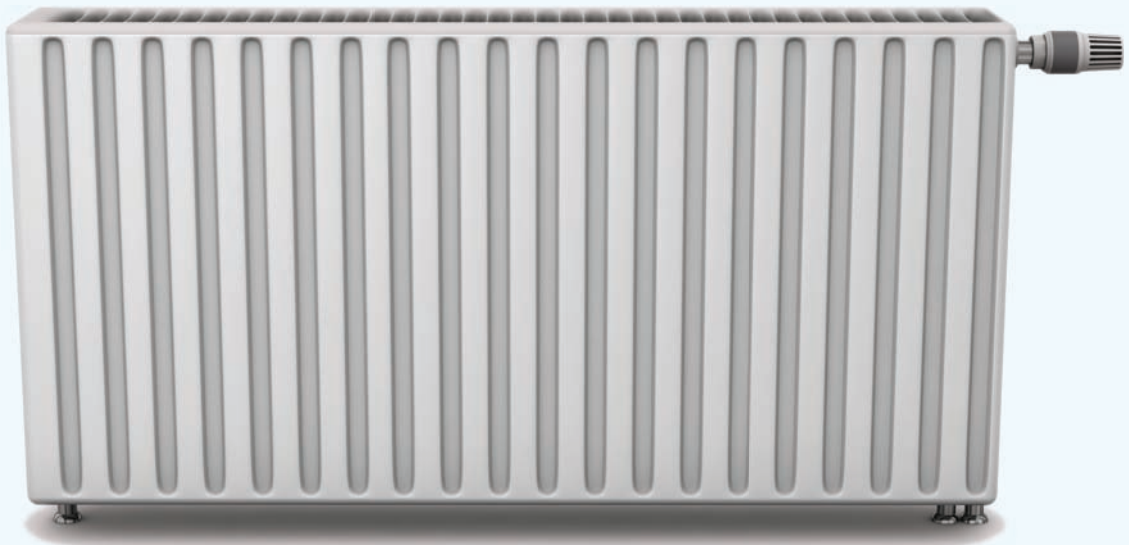


## Practical Perspective

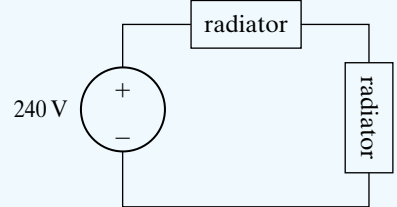
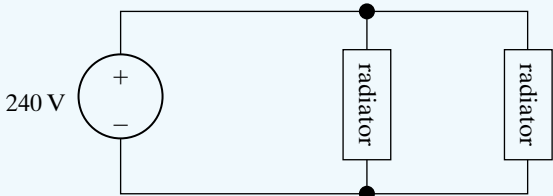
### Heating with Electric Radiators

You want to heat your small garage using a couple of electric radiators. The power and voltage requirements for each radiator are 1200 W, 240 V. But you are not sure how to wire the radiators to the power supplied to the garage. Should you use the wiring diagram on the left, or the one on the right? Does it make any difference?

Once you have studied the material in this chapter, you will be able to answer these questions and determine how to heat the garage. The Practical Perspective at the end of this chapter guides you through the analysis of two circuits based on the two wiring diagrams shown below.



style-photography.de/fotolia



## 2.1 Voltage and Current Sources

Before discussing ideal voltage and current sources, we need to consider the general nature of electrical sources. An **electrical source** is a device that is capable of converting nonelectric energy to electric energy and vice versa. A discharging battery converts chemical energy to electric energy, whereas a battery being charged converts electric energy to chemical energy. A dynamo is a machine that converts mechanical energy to electric energy and vice versa. If operating in the mechanical-to-electric mode, it is called a generator. If transforming from electric to mechanical energy, it is referred to as a motor. The important thing to remember about these sources is that they can either deliver or absorb electric power, generally maintaining either voltage or current. This behavior is of particular interest for circuit analysis and led to the creation of the ideal voltage source and the ideal current source as basic circuit elements. The challenge is to model practical sources in terms of the ideal basic circuit elements.

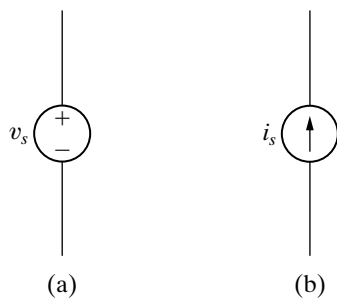
An **ideal voltage source** is a circuit element that maintains a prescribed voltage across its terminals regardless of the current flowing in those terminals. Similarly, an **ideal current source** is a circuit element that maintains a prescribed current through its terminals regardless of the voltage across those terminals. These circuit elements do not exist as practical devices—they are idealized models of actual voltage and current sources.

Using an ideal model for current and voltage sources places an important restriction on how we may describe them mathematically. Because an ideal voltage source provides a steady voltage, even if the current in the element changes, it is impossible to specify the current in an ideal voltage source as a function of its voltage. Likewise, if the only information you have about an ideal current source is the value of current supplied, it is impossible to determine the voltage across that current source. We have sacrificed our ability to relate voltage and current in a practical source for the simplicity of using ideal sources in circuit analysis.

Ideal voltage and current sources can be further described as either independent sources or dependent sources. An **independent source** establishes a voltage or current in a circuit without relying on voltages or currents elsewhere in the circuit. The value of the voltage or current supplied is specified by the value of the independent source alone. In contrast, a **dependent source** establishes a voltage or current whose value depends on the value of a voltage or current elsewhere in the circuit. You cannot specify the value of a dependent source unless you know the value of the voltage or current on which it depends.

The circuit symbols for the ideal independent sources are shown in Fig. 2.1. Note that a circle is used to represent an independent source. To completely specify an ideal independent voltage source in a circuit, you must include the value of the supplied voltage and the reference polarity, as shown in Fig. 2.1(a). Similarly, to completely specify an ideal independent current source, you must include the value of the supplied current and its reference direction, as shown in Fig. 2.1(b).

The circuit symbols for the ideal dependent sources are shown in Fig. 2.2. A diamond is used to represent a dependent source. Both the



**Figure 2.1** ▲ The circuit symbols for (a) an ideal independent voltage source and (b) an ideal independent current source.

dependent current source and the dependent voltage source may be controlled by either a voltage or a current elsewhere in the circuit, so there are a total of four variations, as indicated by the symbols in Fig. 2.2. Dependent sources are sometimes called **controlled sources**.

To completely specify an ideal dependent voltage-controlled voltage source, you must identify the controlling voltage, the equation that permits you to compute the supplied voltage from the controlling voltage, and the reference polarity for the supplied voltage. In Fig. 2.2(a), the controlling voltage is named  $v_x$ , the equation that determines the supplied voltage  $v_s$  is

$$v_s = \mu v_x,$$

and the reference polarity for  $v_s$  is as indicated. Note that  $\mu$  is a multiplying constant that is dimensionless.

Similar requirements exist for completely specifying the other ideal dependent sources. In Fig. 2.2(b), the controlling current is  $i_x$ , the equation for the supplied voltage  $v_s$  is

$$v_s = \rho i_x,$$

the reference polarity is as shown, and the multiplying constant  $\rho$  has the dimension volts per ampere. In Fig. 2.2(c), the controlling voltage is  $v_x$ , the equation for the supplied current  $i_s$  is

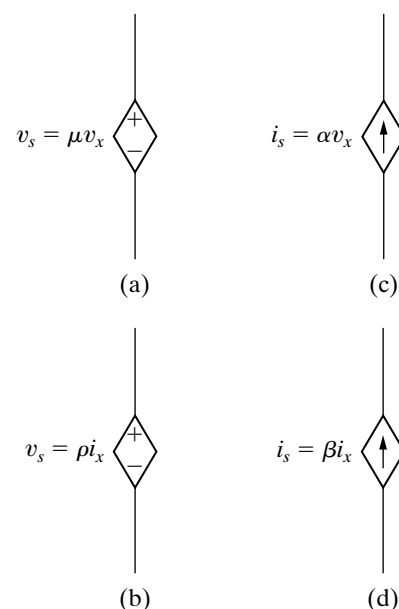
$$i_s = \alpha v_x,$$

the reference direction is as shown, and the multiplying constant  $\alpha$  has the dimension amperes per volt. In Fig. 2.2(d), the controlling current is  $i_x$ , the equation for the supplied current  $i_s$  is

$$i_s = \beta i_x,$$

the reference direction is as shown, and the multiplying constant  $\beta$  is dimensionless.

Finally, in our discussion of ideal sources, we note that they are examples of active circuit elements. An **active element** is one that models a device capable of generating electric energy. **Passive elements** model physical devices that cannot generate electric energy. Resistors, inductors, and capacitors are examples of passive circuit elements. Examples 2.1 and 2.2 illustrate how the characteristics of ideal independent and dependent sources limit the types of permissible interconnections of the sources.



**Figure 2.2** ▲ The circuit symbols for (a) an ideal dependent voltage-controlled voltage source, (b) an ideal dependent current-controlled voltage source, (c) an ideal dependent voltage-controlled current source, and (d) an ideal dependent current-controlled current source.

**Example 2.1** Testing Interconnections of Ideal Sources

Using the definitions of the ideal independent voltage and current sources, state which interconnections in Fig. 2.3 are permissible and which violate the constraints imposed by the ideal sources.

**Solution**

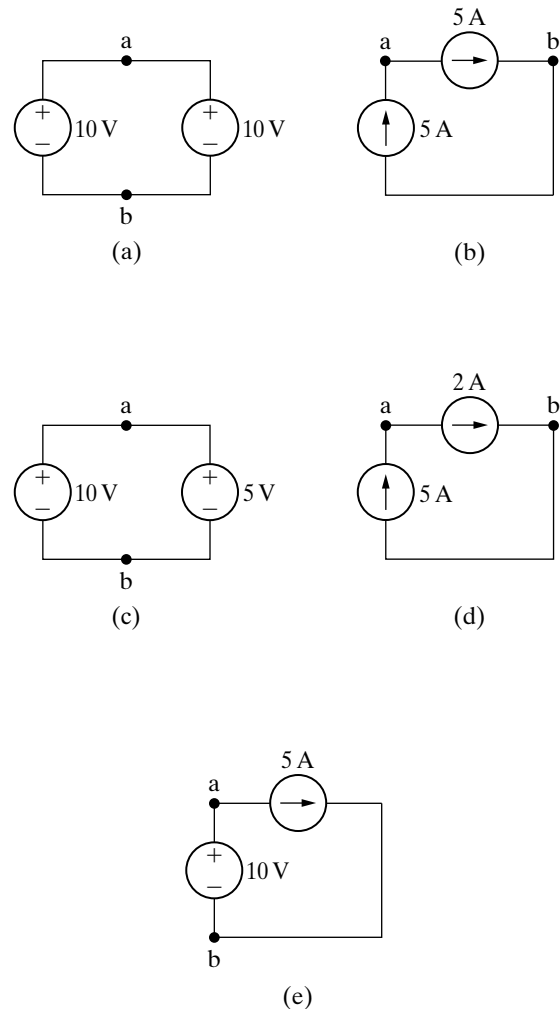
Connection (a) is valid. Each source supplies voltage across the same pair of terminals, marked a,b. This requires that each source supply the same voltage with the same polarity, which they do.

Connection (b) is valid. Each source supplies current through the same pair of terminals, marked a,b. This requires that each source supply the same current in the same direction, which they do.

Connection (c) is not permissible. Each source supplies voltage across the same pair of terminals, marked a,b. This requires that each source supply the same voltage with the same polarity, which they do not.

Connection (d) is not permissible. Each source supplies current through the same pair of terminals, marked a,b. This requires that each source supply the same current in the same direction, which they do not.

Connection (e) is valid. The voltage source supplies voltage across the pair of terminals marked a,b. The current source supplies current through the same pair of terminals. Because an ideal voltage source supplies the same voltage regardless of the current, and an ideal current source supplies the same current regardless of the voltage, this is a permissible connection.



**Figure 2.3** ▲ The circuits for Example 2.1.

**Example 2.2** Testing Interconnections of Ideal Independent and Dependent Sources

Using the definitions of the ideal independent and dependent sources, state which interconnections in Fig. 2.4 are valid and which violate the constraints imposed by the ideal sources.

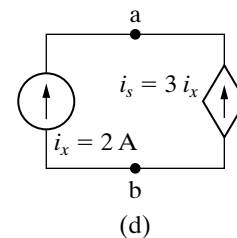
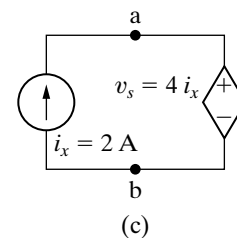
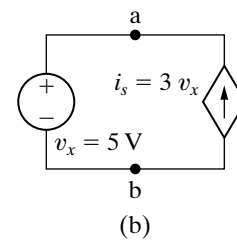
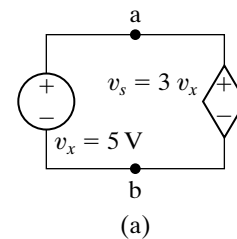
**Solution**

Connection (a) is invalid. Both the independent source and the dependent source supply voltage across the same pair of terminals, labeled a,b. This requires that each source supply the same voltage with the same polarity. The independent source supplies 5 V, but the dependent source supplies 15 V.

Connection (b) is valid. The independent voltage source supplies voltage across the pair of terminals marked a,b. The dependent current source supplies current through the same pair of terminals. Because an ideal voltage source supplies the same voltage regardless of current, and an ideal current source supplies the same current regardless of voltage, this is an allowable connection.

Connection (c) is valid. The independent current source supplies current through the pair of terminals marked a,b. The dependent voltage source supplies voltage across the same pair of terminals. Because an ideal current source supplies the same current regardless of voltage, and an ideal voltage source supplies the same voltage regardless of current, this is an allowable connection.

Connection (d) is invalid. Both the independent source and the dependent source supply current through the same pair of terminals, labeled a,b. This requires that each source supply the same current in the same reference direction. The independent source supplies 2 A, but the dependent source supplies 6 A in the opposite direction.



**Figure 2.4** ▲ The circuits for Example 2.2.

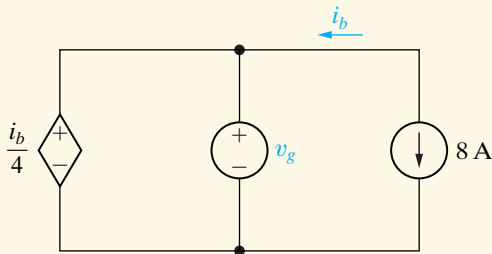


**ASSESSMENT PROBLEMS**

**Objective 1—Understand ideal basic circuit elements**

- 2.1** For the circuit shown,
- What value of  $v_g$  is required in order for the interconnection to be valid?
  - For this value of  $v_g$ , find the power associated with the 8 A source.

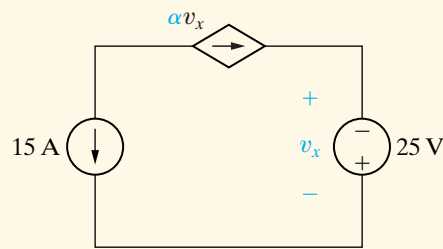
**Answer:** (a)  $-2$  V;  
 (b)  $-16$  W (16 W delivered).



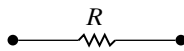
*NOTE: Also try Chapter Problems 2.6 and 2.7.*

- 2.2** For the circuit shown,
- What value of  $\alpha$  is required in order for the interconnection to be valid?
  - For the value of  $\alpha$  calculated in part (a), find the power associated with the 25 V source.

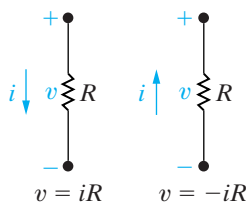
**Answer:** (a)  $0.6$  A/V;  
 (b)  $375$  W (375 W absorbed).



## 2.2 Electrical Resistance (Ohm's Law)



**Figure 2.5** ▲ The circuit symbol for a resistor having a resistance  $R$ .



**Figure 2.6** ▲ Two possible reference choices for the current and voltage at the terminals of a resistor, and the resulting equations.

**Resistance** is the capacity of materials to impede the flow of current or, more specifically, the flow of electric charge. The circuit element used to model this behavior is the **resistor**. Figure 2.5 shows the circuit symbol for the resistor, with  $R$  denoting the resistance value of the resistor.

Conceptually, we can understand resistance if we think about the moving electrons that make up electric current interacting with and being resisted by the atomic structure of the material through which they are moving. In the course of these interactions, some amount of electric energy is converted to thermal energy and dissipated in the form of heat. This effect may be undesirable. However, many useful electrical devices take advantage of resistance heating, including stoves, toasters, irons, and space heaters.

Most materials exhibit measurable resistance to current. The amount of resistance depends on the material. Metals such as copper and aluminum have small values of resistance, making them good choices for wiring used to conduct electric current. In fact, when represented in a circuit diagram, copper or aluminum wiring isn't usually modeled as a resistor; the resistance of the wire is so small compared to the resistance of other elements in the circuit that we can neglect the wiring resistance to simplify the diagram.

For purposes of circuit analysis, we must reference the current in the resistor to the terminal voltage. We can do so in two ways: either in the direction of the voltage drop across the resistor or in the direction of the voltage rise across the resistor, as shown in Fig. 2.6. If we choose the former, the relationship between the voltage and current is

**Ohm's law** ►

$$v = iR, \tag{2.1}$$

where

$$\begin{aligned} v &= \text{the voltage in volts,} \\ i &= \text{the current in amperes,} \\ R &= \text{the resistance in ohms.} \end{aligned}$$

If we choose the second method, we must write

$$v = -iR, \quad (2.2)$$

where  $v$ ,  $i$ , and  $R$  are, as before, measured in volts, amperes, and ohms, respectively. The algebraic signs used in Eqs. 2.1 and 2.2 are a direct consequence of the passive sign convention, which we introduced in Chapter 1.

Equations 2.1 and 2.2 are known as **Ohm's law** after Georg Simon Ohm, a German physicist who established its validity early in the nineteenth century. Ohm's law is the algebraic relationship between voltage and current for a resistor. In SI units, resistance is measured in ohms. The Greek letter omega ( $\Omega$ ) is the standard symbol for an ohm. The circuit diagram symbol for an  $8 \Omega$  resistor is shown in Fig. 2.7.

Ohm's law expresses the voltage as a function of the current. However, expressing the current as a function of the voltage also is convenient. Thus, from Eq. 2.1,

$$i = \frac{v}{R}, \quad (2.3)$$

or, from Eq. 2.2,

$$i = -\frac{v}{R}. \quad (2.4)$$

The reciprocal of the resistance is referred to as **conductance**, is symbolized by the letter  $G$ , and is measured in siemens (S). Thus,

$$G = \frac{1}{R} \text{ S.} \quad (2.5)$$

An  $8 \Omega$  resistor has a conductance value of 0.125 S. In much of the professional literature, the unit used for conductance is the mho (ohm spelled backward), which is symbolized by an inverted omega ( $\mathcal{U}$ ). Therefore we may also describe an  $8 \Omega$  resistor as having a conductance of 0.125 mho, ( $\mathcal{U}$ ).

We use ideal resistors in circuit analysis to model the behavior of physical devices. Using the qualifier *ideal* reminds us that the resistor model makes several simplifying assumptions about the behavior of actual resistive devices. The most important of these simplifying assumptions is that the resistance of the ideal resistor is constant and its value does not vary over time. Most actual resistive devices do not have constant resistance, and their resistance does vary over time. The ideal resistor model can be used to represent a physical device whose resistance doesn't vary much from some constant value over the time period of interest in the circuit analysis. In this book we assume that the simplifying assumptions about resistance devices are valid, and we thus use ideal resistors in circuit analysis.

We may calculate the power at the terminals of a resistor in several ways. The first approach is to use the defining equation and simply calculate

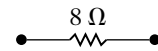


Figure 2.7 ▲ The circuit symbol for an  $8 \Omega$  resistor.

the product of the terminal voltage and current. For the reference systems shown in Fig. 2.6, we write

$$p = vi \quad (2.6)$$

when  $v = iR$  and

$$p = -vi \quad (2.7)$$

when  $v = -iR$ .

A second method of expressing the power at the terminals of a resistor expresses power in terms of the current and the resistance. Substituting Eq. 2.1 into Eq. 2.6, we obtain

$$p = vi = (iR)i$$

so

**Power in a resistor in terms of current ►**

$$p = i^2 R. \quad (2.8)$$

Likewise, substituting Eq. 2.2 into Eq. 2.7, we have

$$p = -vi = -(-iR)i = i^2 R. \quad (2.9)$$

Equations 2.8 and 2.9 are identical and demonstrate clearly that, regardless of voltage polarity and current direction, the power at the terminals of a resistor is positive. Therefore, a resistor absorbs power from the circuit.

A third method of expressing the power at the terminals of a resistor is in terms of the voltage and resistance. The expression is independent of the polarity references, so

**Power in a resistor in terms of voltage ►**

$$p = \frac{v^2}{R}. \quad (2.10)$$

Sometimes a resistor's value will be expressed as a conductance rather than as a resistance. Using the relationship between resistance and conductance given in Eq. 2.5, we may also write Eqs. 2.9 and 2.10 in terms of the conductance, or

$$p = \frac{i^2}{G}, \quad (2.11)$$

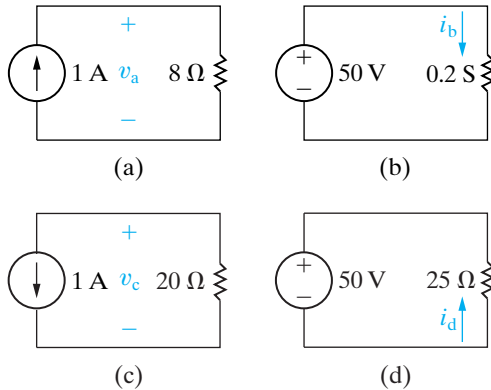
$$p = v^2 G. \quad (2.12)$$

Equations 2.6–2.12 provide a variety of methods for calculating the power absorbed by a resistor. Each yields the same answer. In analyzing a circuit, look at the information provided and choose the power equation that uses that information directly.

Example 2.3 illustrates the application of Ohm's law in conjunction with an ideal source and a resistor. Power calculations at the terminals of a resistor also are illustrated.

**Example 2.3** Calculating Voltage, Current, and Power for a Simple Resistive Circuit

In each circuit in Fig. 2.8, either the value of  $v$  or  $i$  is not known.



**Figure 2.8** ▲ The circuits for Example 2.3.

- Calculate the values of  $v$  and  $i$ .
- Determine the power dissipated in each resistor.

**Solution**

- The voltage  $v_a$  in Fig. 2.8(a) is a drop in the direction of the current in the resistor. Therefore,

$$v_a = (1)(8) = 8 \text{ V.}$$

The current  $i_b$  in the resistor with a conductance of 0.2 S in Fig. 2.8(b) is in the direction of the voltage drop across the resistor. Thus

$$i_b = (50)(0.2) = 10 \text{ A.}$$

The voltage  $v_c$  in Fig. 2.8(c) is a rise in the direction of the current in the resistor. Hence

$$v_c = -(1)(20) = -20 \text{ V.}$$

The current  $i_d$  in the 25 Ω resistor in Fig. 2.8(d) is in the direction of the voltage rise across the resistor. Therefore

$$i_d = \frac{-50}{25} = -2 \text{ A.}$$

- The power dissipated in each of the four resistors is

$$p_{8\Omega} = \frac{(8)^2}{8} = (1)^2(8) = 8 \text{ W,}$$

$$p_{0.2\text{S}} = (50)^2(0.2) = 500 \text{ W,}$$

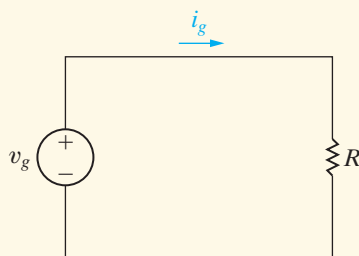
$$p_{20\Omega} = \frac{(-20)^2}{20} = (1)^2(20) = 20 \text{ W,}$$

$$p_{25\Omega} = \frac{(50)^2}{25} = (-2)^2(25) = 100 \text{ W.}$$

**ASSESSMENT PROBLEMS****Objective 2—Be able to state and use Ohm's Law . . .**

**2.3** For the circuit shown,

- If  $v_g = 1 \text{ kV}$  and  $i_g = 5 \text{ mA}$ , find the value of  $R$  and the power absorbed by the resistor.
- If  $i_g = 75 \text{ mA}$  and the power delivered by the voltage source is 3 W, find  $v_g$ ,  $R$ , and the power absorbed by the resistor.
- If  $R = 300 \Omega$  and the power absorbed by  $R$  is 480 mW, find  $i_g$  and  $v_g$ .

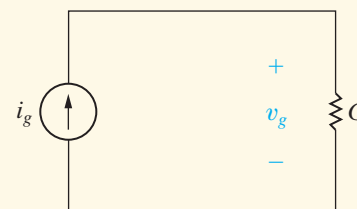


- Answer:** (a) 200 kΩ, 5 W;  
 (b) 40 V, 533.33 Ω, 3 W;  
 (c) 40 mA, 12 V.

**NOTE:** Also try Chapter Problems 2.11 and 2.12.

**2.4** For the circuit shown,

- If  $i_g = 0.5 \text{ A}$  and  $G = 50 \text{ mS}$ , find  $v_g$  and the power delivered by the current source.
- If  $v_g = 15 \text{ V}$  and the power delivered to the conductor is 9 W, find the conductance  $G$  and the source current  $i_g$ .
- If  $G = 200 \mu\text{S}$  and the power delivered to the conductance is 8 W, find  $i_g$  and  $v_g$ .



- Answer:** (a) 10 V, 5 W;  
 (b) 40 mS, 0.6 A;  
 (c) 40 mA, 200 V.

Having introduced the general characteristics of ideal sources and resistors, we next show how to use these elements to build the circuit model of a practical system.

## 2.3 Construction of a Circuit Model

We have already stated that one reason for an interest in the basic circuit elements is that they can be used to construct circuit models of practical systems. The skill required to develop a circuit model of a device or system is as complex as the skill required to solve the derived circuit. Although this text emphasizes the skills required to solve circuits, you also will need other skills in the practice of electrical engineering, and one of the most important is modeling.

We develop circuit models in the next two examples. In Example 2.4 we construct a circuit model based on a knowledge of the behavior of the system's components and how the components are interconnected. In Example 2.5 we create a circuit model by measuring the terminal behavior of a device.

### Example 2.4 Constructing a Circuit Model of a Flashlight

Construct a circuit model of a flashlight.

#### Solution

We chose the flashlight to illustrate a practical system because its components are so familiar. Figure 2.9 shows a photograph of a widely available flashlight.

When a flashlight is regarded as an electrical system, the components of primary interest are the batteries, the lamp, the connector, the case, and the switch. We now consider the circuit model for each component.

A dry-cell battery maintains a reasonably constant terminal voltage if the current demand is not excessive. Thus if the dry-cell battery is operating within its intended limits, we can model it with an ideal voltage source. The prescribed voltage then is constant and equal to the sum of two dry-cell values.

The ultimate output of the lamp is light energy, which is achieved by heating the filament in the lamp to a temperature high enough to cause radiation in the visible range. We can model the lamp with an ideal resistor. Note in this case that although the resistor accounts for the amount of electric energy converted to thermal energy, it does not predict how much of the thermal energy is converted to light energy. The resistor used to represent the lamp does predict the steady current drain on the batteries, a characteristic of the system that also is of interest. In this model,  $R_l$  symbolizes the lamp resistance.

The connector used in the flashlight serves a dual role. First, it provides an electrical conductive path between the dry cells and the case. Second, it is



Thom Lang/Corbis

Figure 2.9 ▲ A flashlight can be viewed as an electrical system.

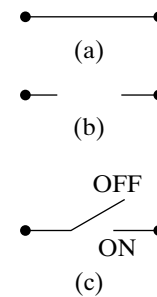
formed into a springy coil so that it also can apply mechanical pressure to the contact between the batteries and the lamp. The purpose of this mechanical pressure is to maintain contact between the two dry cells and between the dry cells and the lamp. Hence, in choosing the wire for the connector, we may find that its mechanical properties are more

important than its electrical properties for the flashlight design. Electrically, we can model the connector with an ideal resistor, labeled  $R_1$ .

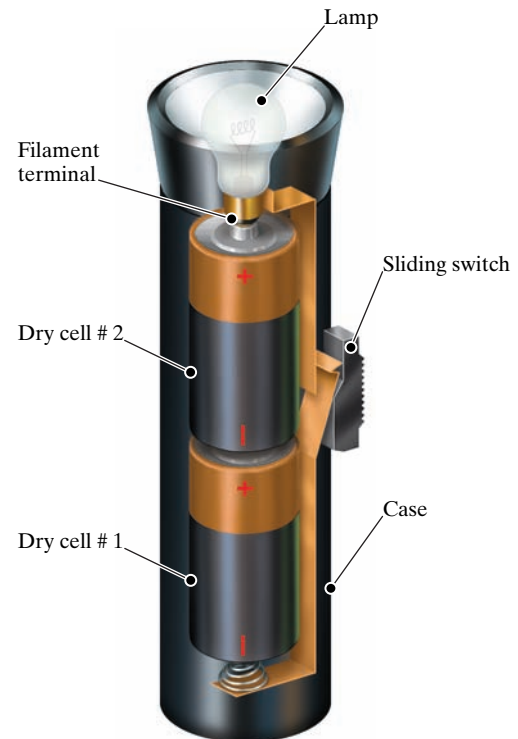
The case also serves both a mechanical and an electrical purpose. Mechanically, it contains all the other components and provides a grip for the person using it. Electrically, it provides a connection between other elements in the flashlight. If the case is metal, it conducts current between the batteries and the lamp. If it is plastic, a metal strip inside the case connects the coiled connector to the switch. Either way, an ideal resistor, which we denote  $R_c$ , models the electrical connection provided by the case.

The final component is the switch. Electrically, the switch is a two-state device. It is either ON or OFF. An ideal switch offers no resistance to the current when it is in the ON state, but it offers infinite resistance to current when it is in the OFF state. These two states represent the limiting values of a resistor; that is, the ON state corresponds to a resistor with a numerical value of zero, and the OFF state corresponds to a resistor with a numerical value of infinity. The two extreme values have the descriptive names **short circuit** ( $R = 0$ ) and **open circuit** ( $R = \infty$ ). Figure 2.10(a) and (b) show the graphical representation of a short circuit and an open circuit, respectively. The symbol shown in Fig. 2.10(c) represents the fact that a switch can be either a short circuit or an open circuit, depending on the position of its contacts.

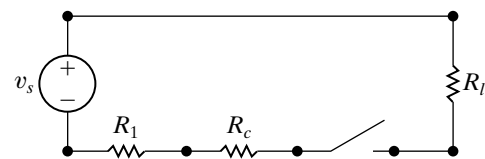
We now construct the circuit model of the flashlight. Starting with the dry-cell batteries, the positive terminal of the first cell is connected to the negative terminal of the second cell, as shown in Fig. 2.11. The positive terminal of the second cell is connected to one terminal of the lamp. The other terminal of the lamp makes contact with one side of the switch, and the other side of the switch is connected to the metal case. The metal case is then connected to the negative terminal of the first dry cell by means of the metal spring. Note that the elements form a closed path or circuit. You can see the closed path formed by the connected elements in Fig. 2.11. Figure 2.12 shows a circuit model for the flashlight.



**Figure 2.10** ▲ Circuit symbols. (a) Short circuit. (b) Open circuit. (c) Switch.



**Figure 2.11** ▲ The arrangement of flashlight components.



**Figure 2.12** ▲ A circuit model for a flashlight.

We can make some general observations about modeling from our flashlight example: First, in developing a circuit model, the *electrical* behavior of each physical component is of primary interest. In the flashlight model, three very different physical components—a lamp, a coiled wire, and a metal case—are all represented by the same circuit element (a resistor), because the electrical phenomenon taking place in each is the same. Each is presenting resistance to the current flowing through the circuit.

Second, circuit models may need to account for undesired as well as desired electrical effects. For example, the heat resulting from the resistance in the lamp produces the light, a desired effect. However, the heat

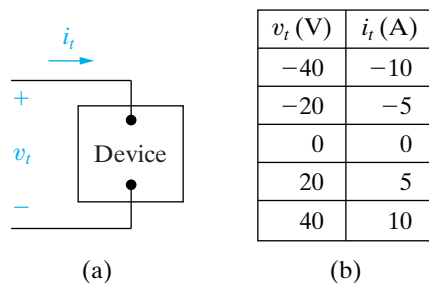
resulting from the resistance in the case and coil represents an unwanted or parasitic effect. It drains the dry cells and produces no useful output. Such parasitic effects must be considered or the resulting model may not adequately represent the system.

And finally, modeling requires approximation. Even for the basic system represented by the flashlight, we made simplifying assumptions in developing the circuit model. For example, we assumed an ideal switch, but in practical switches, contact resistance may be high enough to interfere with proper operation of the system. Our model does not predict this behavior. We also assumed that the coiled connector exerts enough pressure to eliminate any contact resistance between the dry cells. Our model does not predict the effect of inadequate pressure. Our use of an ideal voltage source ignores any internal dissipation of energy in the dry cells, which might be due to the parasitic heating just mentioned. We could account for this by adding an ideal resistor between the source and the lamp resistor. Our model assumes the internal loss to be negligible.

In modeling the flashlight as a circuit, we had a basic understanding of and access to the internal components of the system. However, sometimes we know only the terminal behavior of a device and must use this information in constructing the model. Example 2.5 explores such a modeling problem.

### Example 2.5 Constructing a Circuit Model Based on Terminal Measurements

The voltage and current are measured at the terminals of the device illustrated in Fig. 2.13(a), and the values of  $v_t$  and  $i_t$  are tabulated in Fig. 2.13(b). Construct a circuit model of the device inside the box.

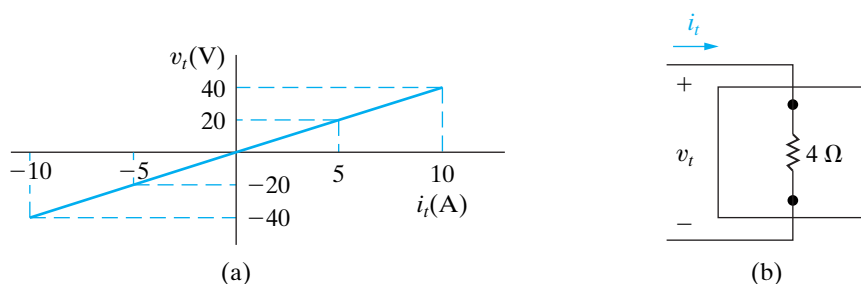


**Figure 2.13** ▲ The (a) device and (b) data for Example 2.5.

### Solution

Plotting the voltage as a function of the current yields the graph shown in Fig. 2.14(a). The equation of the line in this figure illustrates that the terminal voltage is directly proportional to the terminal current,  $v_t = 4i_t$ . In terms of Ohm's law, the device inside the box behaves like a  $4\ \Omega$  resistor. Therefore, the circuit model for the device inside the box is a  $4\ \Omega$  resistor, as seen in Fig. 2.14(b).

We come back to this technique of using terminal characteristics to construct a circuit model after introducing Kirchhoff's laws and circuit analysis.



**Figure 2.14** ▲ (a) The values of  $v_t$  versus  $i_t$  for the device in Fig. 2.13. (b) The circuit model for the device in Fig. 2.13.

**NOTE:** Assess your understanding of this example by trying Chapter Problems 2.14 and 2.15.



## 2.4 Kirchoff's Laws

A circuit is said to be solved when the voltage across and the current in every element have been determined. Ohm's law is an important equation for deriving such solutions. However, Ohm's law may not be enough to provide a complete solution. As we shall see in trying to solve the flashlight circuit from Example 2.4, we need to use two more important algebraic relationships, known as Kirchoff's laws, to solve most circuits.

We begin by redrawing the circuit as shown in Fig. 2.15, with the switch in the ON state. Note that we have also labeled the current and voltage variables associated with each resistor and the current associated with the voltage source. Labeling includes reference polarities, as always. For convenience, we attach the same subscript to the voltage and current labels as we do to the resistor labels. In Fig. 2.15, we also removed some of the terminal dots of Fig. 2.12 and have inserted nodes. Terminal dots are the start and end points of an individual circuit element. A **node** is a point where two or more circuit elements meet. It is necessary to identify nodes in order to use Kirchoff's current law, as we will see in a moment. In Fig. 2.15, the nodes are labeled a, b, c, and d. Node d connects the battery and the lamp and in essence stretches all the way across the top of the diagram, though we label a single point for convenience. The dots on either side of the switch indicate its terminals, but only one is needed to represent a node, so only one is labeled node c.

For the circuit shown in Fig. 2.15, we can identify seven unknowns:  $i_s$ ,  $i_1$ ,  $i_c$ ,  $i_l$ ,  $v_1$ ,  $v_c$ , and  $v_l$ . Recall that  $v_s$  is a known voltage, as it represents the sum of the terminal voltages of the two dry cells, a constant voltage of 3 V. The problem is to find the seven unknown variables. From algebra, you know that to find  $n$  unknown quantities you must solve  $n$  simultaneous independent equations. From our discussion of Ohm's law in Section 2.2, you know that three of the necessary equations are

$$v_1 = i_1 R_1, \quad (2.13)$$

$$v_c = i_c R_c, \quad (2.14)$$

$$v_l = i_l R_l. \quad (2.15)$$

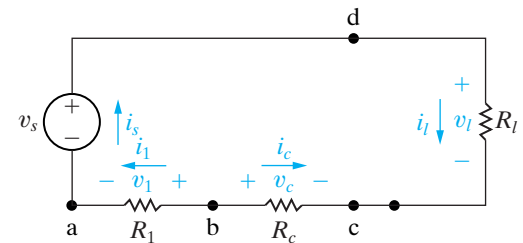
What about the other four equations?

The interconnection of circuit elements imposes constraints on the relationship between the terminal voltages and currents. These constraints are referred to as Kirchoff's laws, after Gustav Kirchoff, who first stated them in a paper published in 1848. The two laws that state the constraints in mathematical form are known as Kirchoff's current law and Kirchoff's voltage law.

We can now state **Kirchoff's current law**:

The algebraic sum of all the currents at any node in a circuit equals zero.

To use Kirchoff's current law, an algebraic sign corresponding to a reference direction must be assigned to every current at the node. Assigning a positive sign to a current leaving a node requires assigning a negative sign to a current entering a node. Conversely, giving a negative sign to a current leaving a node requires giving a positive sign to a current entering a node.



**Figure 2.15** ▲ Circuit model of the flashlight with assigned voltage and current variables.

### ◀ Kirchoff's current law (KCL)

Applying Kirchhoff's current law to the four nodes in the circuit shown in Fig. 2.15, using the convention that currents leaving a node are considered positive, yields four equations:

$$\text{node a} \quad i_s - i_1 = 0, \quad (2.16)$$

$$\text{node b} \quad i_1 + i_c = 0, \quad (2.17)$$

$$\text{node c} \quad -i_c - i_l = 0, \quad (2.18)$$

$$\text{node d} \quad i_l - i_s = 0. \quad (2.19)$$

Note that Eqs. 2.16–2.19 are not an independent set, because any one of the four can be derived from the other three. In any circuit with  $n$  nodes,  $n - 1$  independent current equations can be derived from Kirchhoff's current law.<sup>1</sup> Let's disregard Eq. 2.19 so that we have six independent equations, namely, Eqs. 2.13–2.18. We need one more, which we can derive from Kirchhoff's voltage law.

Before we can state Kirchhoff's voltage law, we must define a **closed path** or **loop**. Starting at an arbitrarily selected node, we trace a closed path in a circuit through selected basic circuit elements and return to the original node without passing through any intermediate node more than once. The circuit shown in Fig. 2.15 has only one closed path or loop. For example, choosing node a as the starting point and tracing the circuit clockwise, we form the closed path by moving through nodes d, c, b, and back to node a. We can now state **Kirchhoff's voltage law**:

### Kirchhoff's voltage law (KVL) ►

The algebraic sum of all the voltages around any closed path in a circuit equals zero.

To use Kirchhoff's voltage law, we must assign an algebraic sign (reference direction) to each voltage in the loop. As we trace a closed path, a voltage will appear either as a rise or a drop in the tracing direction. Assigning a positive sign to a voltage rise requires assigning a negative sign to a voltage drop. Conversely, giving a negative sign to a voltage rise requires giving a positive sign to a voltage drop.

We now apply Kirchhoff's voltage law to the circuit shown in Fig. 2.15. We elect to trace the closed path clockwise, assigning a positive algebraic sign to voltage drops. Starting at node d leads to the expression

$$v_l - v_c + v_1 - v_s = 0, \quad (2.20)$$

which represents the seventh independent equation needed to find the seven unknown circuit variables mentioned earlier.

The thought of having to solve seven simultaneous equations to find the current delivered by a pair of dry cells to a flashlight lamp is not very appealing. Thus in the coming chapters we introduce you to analytical techniques that will enable you to solve a simple one-loop circuit by writing a single equation. However, before moving on to a discussion of these circuit techniques, we need to make several observations about the detailed analysis of the flashlight circuit. In general, these observations are true and therefore are important to the discussions in subsequent chapters. They also support the contention that the flashlight circuit can be solved by defining a single unknown.

<sup>1</sup> We say more about this observation in Chapter 4.

First, note that if you know the current in a resistor, you also know the voltage across the resistor, because current and voltage are directly related through Ohm's law. Thus you can associate one unknown variable with each resistor, either the current or the voltage. Choose, say, the current as the unknown variable. Then, once you solve for the unknown current in the resistor, you can find the voltage across the resistor. In general, if you know the current in a passive element, you can find the voltage across it, greatly reducing the number of simultaneous equations to be solved. For example, in the flashlight circuit, we eliminate the voltages  $v_c$ ,  $v_l$ , and  $v_1$  as unknowns. Thus at the outset we reduce the analytical task to solving four simultaneous equations rather than seven.

The second general observation relates to the consequences of connecting only two elements to form a node. According to Kirchhoff's current law, when only two elements connect to a node, if you know the current in one of the elements, you also know it in the second element. In other words, you need define only one unknown current for the two elements. When just two elements connect at a single node, the elements are said to be **in series**. The importance of this second observation is obvious when you note that each node in the circuit shown in Fig. 2.15 involves only two elements. Thus you need to define only one unknown current. The reason is that Eqs. 2.16–2.18 lead directly to

$$i_s = i_1 = -i_c = i_l, \quad (2.21)$$

which states that if you know any one of the element currents, you know them all. For example, choosing to use  $i_s$  as the unknown eliminates  $i_1$ ,  $i_c$ , and  $i_l$ . The problem is reduced to determining one unknown, namely,  $i_s$ .

Examples 2.6 and 2.7 illustrate how to write circuit equations based on Kirchhoff's laws. Example 2.8 illustrates how to use Kirchhoff's laws and Ohm's law to find an unknown current. Example 2.9 expands on the technique presented in Example 2.5 for constructing a circuit model for a device whose terminal characteristics are known.

### Example 2.6 Using Kirchhoff's Current Law

Sum the currents at each node in the circuit shown in Fig. 2.16. Note that there is no connection dot ( $\bullet$ ) in the center of the diagram, where the  $4\ \Omega$  branch crosses the branch containing the ideal current source  $i_a$ .

#### Solution

In writing the equations, we use a positive sign for a current leaving a node. The four equations are

$$\text{node a} \quad i_1 + i_4 - i_2 - i_5 = 0,$$

$$\text{node b} \quad i_2 + i_3 - i_1 - i_b - i_a = 0,$$

$$\text{node c} \quad i_b - i_3 - i_4 - i_c = 0,$$

$$\text{node d} \quad i_5 + i_a + i_c = 0.$$

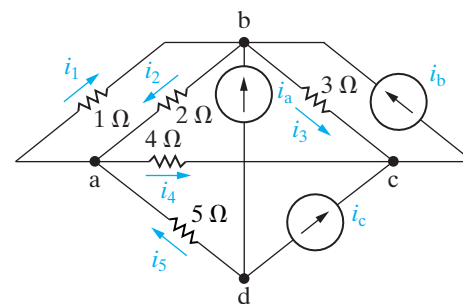


Figure 2.16 ▲ The circuit for Example 2.6.

**Example 2.7 Using Kirchhoff's Voltage Law**

Sum the voltages around each designated path in the circuit shown in Fig. 2.17.

**Solution**

In writing the equations, we use a positive sign for a voltage drop. The four equations are

path a  $-v_1 + v_2 + v_4 - v_b - v_3 = 0,$

path b  $-v_a + v_3 + v_5 = 0,$

path c  $v_b - v_4 - v_c - v_6 - v_5 = 0,$

path d  $-v_a - v_1 + v_2 - v_c + v_7 - v_d = 0.$

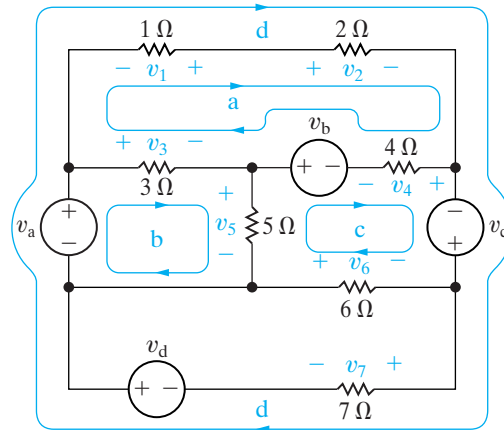


Figure 2.17 ▲ The circuit for Example 2.7.

**Example 2.8 Applying Ohm's Law and Kirchhoff's Laws to Find an Unknown Current**

a) Use Kirchhoff's laws and Ohm's law to find  $i_o$  in the circuit shown in Fig. 2.18.

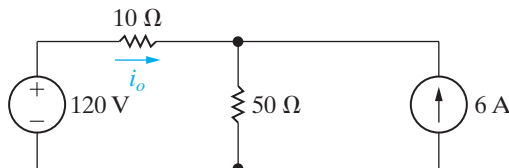


Figure 2.18 ▲ The circuit for Example 2.8.

b) Test the solution for  $i_o$  by verifying that the total power generated equals the total power dissipated.

**Solution**

a) We begin by redrawing the circuit and assigning an unknown current to the 50 Ω resistor and unknown voltages across the 10 Ω and 50 Ω resistors. Figure 2.19 shows the circuit. The nodes are labeled a, b, and c to aid the discussion.

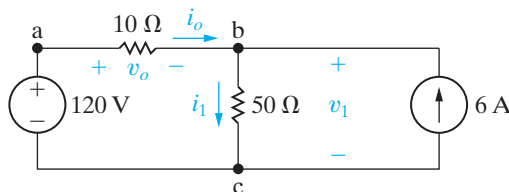


Figure 2.19 ▲ The circuit shown in Fig. 2.18, with the unknowns  $i_1$ ,  $v_o$ , and  $v_1$  defined.

Because  $i_o$  also is the current in the 120 V source, we have two unknown currents and

therefore must derive two simultaneous equations involving  $i_o$  and  $i_1$ . We obtain one of the equations by applying Kirchhoff's current law to either node b or c. Summing the currents at node b and assigning a positive sign to the currents leaving the node gives

$$i_1 - i_o - 6 = 0.$$

We obtain the second equation from Kirchhoff's voltage law in combination with Ohm's law. Noting from Ohm's law that  $v_o$  is  $10i_o$  and  $v_1$  is  $50i_1$ , we sum the voltages around the closed path abc to obtain

$$-120 + 10i_o + 50i_1 = 0.$$

In writing this equation, we assigned a positive sign to voltage drops in the clockwise direction. Solving these two equations for  $i_o$  and  $i_1$  yields

$$i_o = -3 \text{ A} \quad \text{and} \quad i_1 = 3 \text{ A}.$$

b) The power dissipated in the 50 Ω resistor is

$$p_{50\Omega} = (3)^2(50) = 450 \text{ W}.$$

The power dissipated in the 10 Ω resistor is

$$p_{10\Omega} = (-3)^2(10) = 90 \text{ W}.$$

The power delivered to the 120 V source is

$$p_{120\text{V}} = -120i_o = -120(-3) = 360 \text{ W.}$$

The power delivered to the 6 A source is

$$p_{6\text{A}} = -v_1(6), \quad \text{but} \quad v_1 = 50i_1 = 150 \text{ V.}$$

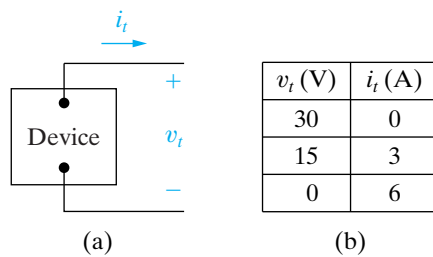
Therefore

$$p_{6\text{A}} = -150(6) = -900 \text{ W.}$$

The 6 A source is delivering 900 W, and the 120 V source is absorbing 360 W. The total power absorbed is  $360 + 450 + 90 = 900 \text{ W}$ . Therefore, the solution verifies that the power delivered equals the power absorbed.

### Example 2.9 Constructing a Circuit Model Based on Terminal Measurements

The terminal voltage and terminal current were measured on the device shown in Fig. 2.20(a), and the values of  $v_t$  and  $i_t$  are tabulated in Fig. 2.20(b).



**Figure 2.20** ▲ (a) Device and (b) data for Example 2.9.

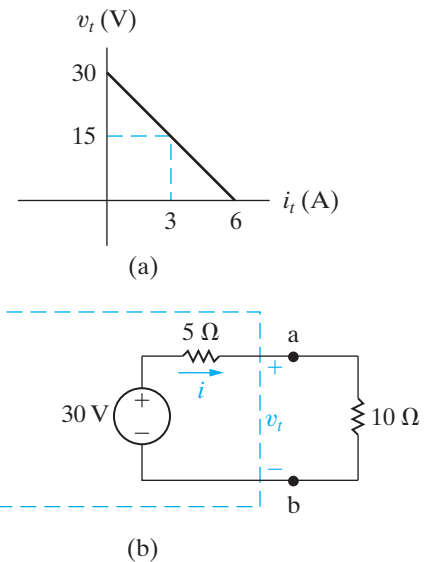
- Construct a circuit model of the device inside the box.
- Using this circuit model, predict the power this device will deliver to a  $10 \Omega$  resistor.

#### Solution

- Plotting the voltage as a function of the current yields the graph shown in Fig. 2.21(a). The equation of the line plotted is

$$v_t = 30 - 5i_t.$$

Now we need to identify the components of a circuit model that will produce the same relationship between voltage and current. Kirchhoff's voltage law tells us that the voltage drops across two components in series. From the equation, one of those components produces a 30 V drop regardless of the current. This component can be modeled as an ideal independent voltage source. The other component produces a positive voltage drop in the direction of the current  $i_t$ . Because the voltage drop is proportional to the current, Ohm's law tells us that this component can be modeled as an ideal resistor with a value of  $5 \Omega$ . The resulting circuit model is depicted in the dashed box in Fig. 2.21(b).



**Figure 2.21** ▲ (a) The graph of  $v_t$  versus  $i_t$  for the device in Fig. 2.20(a). (b) The resulting circuit model for the device in Fig. 2.20(a), connected to a  $10 \Omega$  resistor.

- Now we attach a  $10 \Omega$  resistor to the device in Fig. 2.21(b) to complete the circuit. Kirchhoff's current law tells us that the current in the  $10 \Omega$  resistor is the same as the current in the  $5 \Omega$  resistor. Using Kirchhoff's voltage law and Ohm's law, we can write the equation for the voltage drops around the circuit, starting at the voltage source and proceeding clockwise:

$$-30 + 5i + 10i = 0.$$

Solving for  $i$ , we get

$$i = 2 \text{ A.}$$

Because this is the value of current flowing in the  $10 \Omega$  resistor, we can use the power equation  $p = i^2 R$  to compute the power delivered to this resistor:

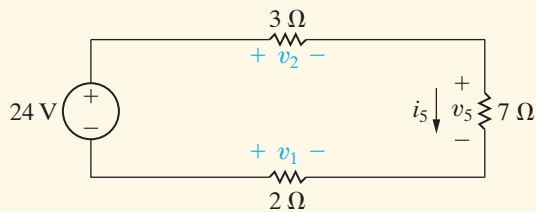
$$p_{10\Omega} = (2)^2(10) = 40 \text{ W.}$$

## ASSESSMENT PROBLEMS

**Objective 2—Be able to state and use Ohm's law and Kirchhoff's current and voltage laws**

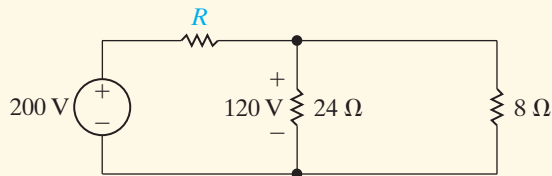
**2.5** For the circuit shown, calculate (a)  $i_5$ ; (b)  $v_1$ ; (c)  $v_2$ ; (d)  $v_5$ ; and (e) the power delivered by the 24 V source.

**Answer:** (a) 2 A;  
 (b) -4 V;  
 (c) 6 V;  
 (d) 14 V;  
 (e) 48 W.



**2.6** Use Ohm's law and Kirchhoff's laws to find the value of  $R$  in the circuit shown.

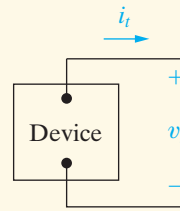
**Answer:**  $R = 4 \Omega$ .



**NOTE:** Also try Chapter Problems 2.18, 2.19, 2.29, and 2.31.

**2.7** a) The terminal voltage and terminal current were measured on the device shown. The values of  $v_t$  and  $i_t$  are provided in the table. Using these values, create the straight line plot of  $v_t$  versus  $i_t$ . Compute the equation of the line and use the equation to construct a circuit model for the device using an ideal voltage source and a resistor.  
 b) Use the model constructed in (a) to predict the power that the device will deliver to a 25  $\Omega$  resistor.

**Answer:** (a) A 25 V source in series with a 100  $\Omega$  resistor;  
 (b) 1 W.



$v_t$ (V)	$i_t$ (A)
25	0
15	0.1
5	0.2
0	0.25

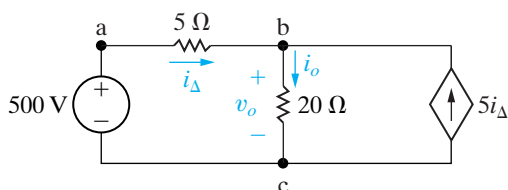
(a)

(b)

**2.8** Repeat Assessment Problem 2.7 but use the equation of the graphed line to construct a circuit model containing an ideal current source and a resistor.

**Answer:** (a) A 0.25 A current source connected between the terminals of a 100  $\Omega$  resistor;  
 (b) 1 W.

## 2.5 Analysis of a Circuit Containing Dependent Sources



**Figure 2.22** ▲ A circuit with a dependent source.

We conclude this introduction to elementary circuit analysis with a discussion of a circuit that contains a dependent source, as depicted in Fig. 2.22.

We want to use Kirchhoff's laws and Ohm's law to find  $v_o$  in this circuit. Before writing equations, it is good practice to examine the circuit diagram closely. This will help us identify the information that is known and the information we must calculate. It may also help us devise a strategy for solving the circuit using only a few calculations.

A look at the circuit in Fig. 2.22 reveals that

- Once we know  $i_o$ , we can calculate  $v_o$  using Ohm's law.
- Once we know  $i_\Delta$ , we also know the current supplied by the dependent source  $5i_\Delta$ .
- The current in the 500 V source is  $i_\Delta$ .

There are thus two unknown currents,  $i_\Delta$  and  $i_o$ . We need to construct and solve two independent equations involving these two currents to produce a value for  $v_o$ .

From the circuit, notice the closed path containing the voltage source, the 5  $\Omega$  resistor, and the 20  $\Omega$  resistor. We can apply Kirchhoff's voltage law around this closed path. The resulting equation contains the two unknown currents:

$$500 = 5i_\Delta + 20i_o. \quad (2.22)$$

Now we need to generate a second equation containing these two currents. Consider the closed path formed by the 20  $\Omega$  resistor and the dependent current source. If we attempt to apply Kirchhoff's voltage law to this loop, we fail to develop a useful equation, because we don't know the value of the voltage across the dependent current source. In fact, the voltage across the dependent source is  $v_o$ , which is the voltage we are trying to compute. Writing an equation for this loop does not advance us toward a solution. For this same reason, we do not use the closed path containing the voltage source, the 5  $\Omega$  resistor, and the dependent source.

There are three nodes in the circuit, so we turn to Kirchhoff's current law to generate the second equation. Node a connects the voltage source and the 5  $\Omega$  resistor; as we have already observed, the current in these two elements is the same. Either node b or node c can be used to construct the second equation from Kirchhoff's current law. We select node b and produce the following equation:

$$i_o = i_\Delta + 5i_\Delta = 6i_\Delta. \quad (2.23)$$

Solving Eqs. 2.22 and 2.23 for the currents, we get

$$\begin{aligned} i_\Delta &= 4 \text{ A}, \\ i_o &= 24 \text{ A}. \end{aligned} \quad (2.24)$$

Using Eq. 2.24 and Ohm's law for the 20  $\Omega$  resistor, we can solve for the voltage  $v_o$ :

$$v_o = 20i_o = 480 \text{ V}.$$

Think about a circuit analysis strategy before beginning to write equations. As we have demonstrated, not every closed path provides an opportunity to write a useful equation based on Kirchhoff's voltage law. Not every node provides for a useful application of Kirchhoff's current law. Some preliminary thinking about the problem can help in selecting the most fruitful approach and the most useful analysis tools for a particular



problem. Choosing a good approach and the appropriate tools will usually reduce the number and complexity of equations to be solved. Example 2.10 illustrates another application of Ohm's law and Kirchhoff's laws to a circuit with a dependent source. Example 2.11 involves a much more complicated circuit, but with a careful choice of analysis tools, the analysis is relatively uncomplicated.

### Example 2.10 Applying Ohm's Law and Kirchhoff's Laws to Find an Unknown Voltage

- a) Use Kirchhoff's laws and Ohm's law to find the voltage  $v_o$  as shown in Fig. 2.23.
- b) Show that your solution is consistent with the constraint that the total power developed in the circuit equals the total power dissipated.

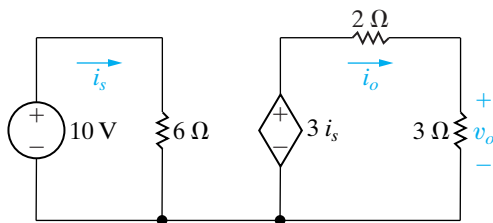


Figure 2.23 ▲ The circuit for Example 2.10.

#### Solution

- a) A close look at the circuit in Fig. 2.23 reveals that:
- There are two closed paths, the one on the left with the current  $i_s$  and the one on the right with the current  $i_o$ .
  - Once  $i_o$  is known, we can compute  $v_o$ .
- We need two equations for the two currents. Because there are two closed paths and both have voltage sources, we can apply Kirchhoff's voltage law to each to give the following equations:

$$10 = 6i_s,$$

$$3i_s = 2i_o + 3i_o.$$

Solving for the currents yields

$$i_s = 1.67 \text{ A},$$

$$i_o = 1 \text{ A}.$$

Applying Ohm's law to the  $3 \Omega$  resistor gives the desired voltage:

$$v_o = 3i_o = 3 \text{ V}.$$

- b) To compute the power delivered to the voltage sources, we use the power equation in the form  $p = vi$ . The power delivered to the independent voltage source is

$$p = (10)(-1.67) = -16.7 \text{ W}.$$

The power delivered to the dependent voltage source is

$$p = (3i_s)(-i_o) = (5)(-1) = -5 \text{ W}.$$

Both sources are developing power, and the total developed power is 21.7 W.

To compute the power delivered to the resistors, we use the power equation in the form  $p = i^2R$ . The power delivered to the  $6 \Omega$  resistor is

$$p = (1.67)^2(6) = 16.7 \text{ W}.$$

The power delivered to the  $2 \Omega$  resistor is

$$p = (1)^2(2) = 2 \text{ W}.$$

The power delivered to the  $3 \Omega$  resistor is

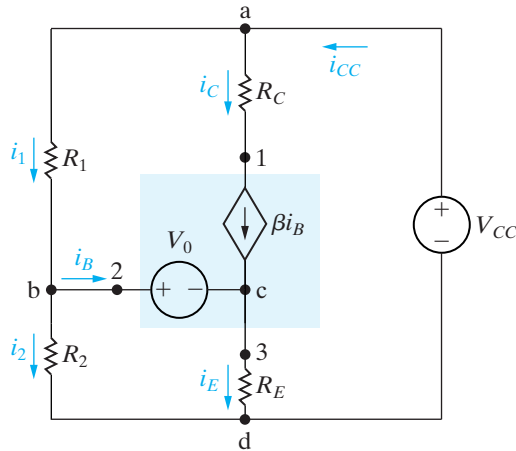
$$p = (1)^2(3) = 3 \text{ W}.$$

The resistors all dissipate power, and the total power dissipated is 21.7 W, equal to the total power developed in the sources.

**Example 2.11** Applying Ohm's Law and Kirchhoff's Law in an Amplifier Circuit

The circuit in Fig. 2.24 represents a common configuration encountered in the analysis and design of transistor amplifiers. Assume that the values of all the circuit elements— $R_1$ ,  $R_2$ ,  $R_C$ ,  $R_E$ ,  $V_{CC}$ , and  $V_0$ —are known.

- Develop the equations needed to determine the current in each element of this circuit.
- From these equations, devise a formula for computing  $i_B$  in terms of the circuit element values.



**Figure 2.24** ▲ The circuit for Example 2.11.

**Solution**

A careful examination of the circuit reveals a total of six unknown currents, designated  $i_1$ ,  $i_2$ ,  $i_B$ ,  $i_C$ ,  $i_E$ , and  $i_{CC}$ . In defining these six unknown currents, we used the observation that the resistor  $R_C$  is in series with the dependent current source  $\beta i_B$ . We now must derive six independent equations involving these six unknowns.

- We can derive three equations by applying Kirchhoff's current law to any three of the nodes a, b, c, and d. Let's use nodes a, b, and c and label the currents away from the nodes as positive:

$$(1) \quad i_1 + i_C - i_{CC} = 0,$$

$$(2) \quad i_B + i_2 - i_1 = 0,$$

$$(3) \quad i_E - i_B - i_C = 0.$$

A fourth equation results from imposing the constraint presented by the series connection of  $R_C$  and the dependent source:

$$(4) \quad i_C = \beta i_B.$$

We turn to Kirchhoff's voltage law in deriving the remaining two equations. We need to select two closed paths in order to use Kirchhoff's voltage law. Note that the voltage across the dependent current source is unknown, and that it cannot be determined from the source current  $\beta i_B$ . Therefore, we must select two closed paths that do not contain this dependent current source.

We choose the paths  $bcdb$  and  $badb$  and specify voltage drops as positive to yield

$$(5) \quad V_0 + i_E R_E - i_2 R_2 = 0,$$

$$(6) \quad -i_1 R_1 + V_{CC} - i_2 R_2 = 0.$$

- To get a single equation for  $i_B$  in terms of the known circuit variables, you can follow these steps:

- Solve Eq. (6) for  $i_1$ , and substitute this solution for  $i_1$  into Eq. (2).
- Solve the transformed Eq. (2) for  $i_2$ , and substitute this solution for  $i_2$  into Eq. (5).
- Solve the transformed Eq. (5) for  $i_E$ , and substitute this solution for  $i_E$  into Eq. (3). Use Eq. (4) to eliminate  $i_C$  in Eq. (3).
- Solve the transformed Eq. (3) for  $i_B$ , and rearrange the terms to yield

$$i_B = \frac{(V_{CC} R_2)/(R_1 + R_2) - V_0}{(R_1 R_2)/(R_1 + R_2) + (1 + \beta) R_E}. \quad (2.25)$$

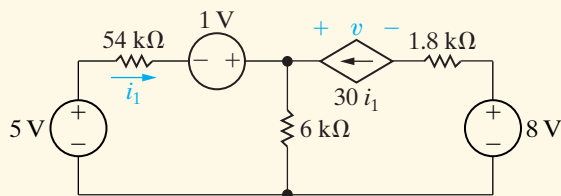
Problem 2.31 asks you to verify these steps. Note that once we know  $i_B$ , we can easily obtain the remaining currents.

**ASSESSMENT PROBLEMS**

**Objective 3—Know how to calculate power for each element in a simple circuit**

**2.9** For the circuit shown find (a) the current  $i_1$  in microamperes, (b) the voltage  $v$  in volts, (c) the total power generated, and (d) the total power absorbed.

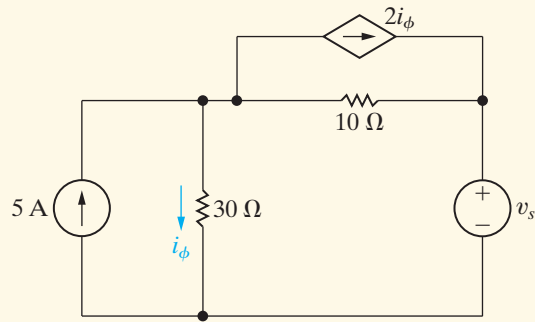
**Answer:** (a)  $25 \mu\text{A}$ ;  
 (b)  $-2 \text{ V}$ ;  
 (c)  $6150 \mu\text{W}$ ;  
 (d)  $6150 \mu\text{W}$ .



**2.10** The current  $i_\phi$  in the circuit shown is 2 A. Calculate  
 a)  $v_s$ ,  
 b) the power absorbed by the independent voltage source,

c) the power delivered by the independent current source,  
 d) the power delivered by the controlled current source,  
 e) the total power dissipated in the two resistors.

**Answer:** (a)  $70 \text{ V}$ ;  
 (b)  $210 \text{ W}$ ;  
 (c)  $300 \text{ W}$ ;  
 (d)  $40 \text{ W}$ ;  
 (e)  $130 \text{ W}$ .

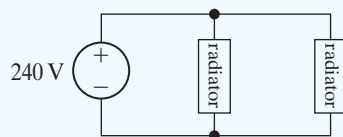


*NOTE: Also try Chapter Problems 2.32 and 2.33.*

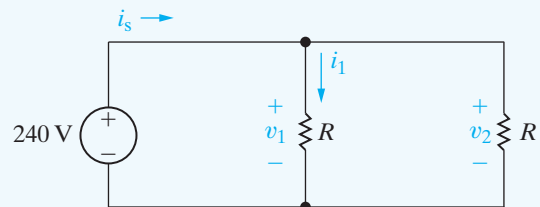
## Practical Perspective

### Heating with Electric Radiators

Let's determine which of the two wiring diagrams introduced at the beginning of this chapter should be used to wire the electric radiators to the power supplied to the garage. We begin with the diagram shown in Fig. 2.25. We can turn this into a circuit by modeling the radiators as resistors. The resulting circuit is shown in Fig. 2.26. Note that each radiator has the same resistance,  $R$ , and is labeled with a voltage and current value.



**Figure 2.25** A wiring diagram for two radiators.



**Figure 2.26** A circuit based on Fig. 2.25.

To find the unknown voltages and currents for the circuit in Fig. 2.26, begin by writing a KVL equation for the left side of the circuit:

$$-240 + v_1 = 0 \Rightarrow v_1 = 240 \text{ V}.$$

Now write a KVL equation for the right side of this circuit:

$$-v_1 + v_2 = 0 \quad \Rightarrow \quad v_2 = v_1 = 240 \text{ V.}$$

Remember that the power and voltage specifications for each radiator are 1200 W, 240 V. Therefore the configuration shown in Fig. 2.25 satisfies the voltage specification, since each radiator would have a supplied voltage of 240 V.

Next, calculate the value of resistance  $R$  that will correctly model each radiator. We want the power associated with each radiator to be 1200 W. Use the equation for resistor power that involves the resistance and the voltage:

$$P_1 = \frac{v_1^2}{R} = \frac{v_2^2}{R} = P_2 \quad \Rightarrow \quad R = \frac{v_1^2}{P_1} = \frac{240^2}{1200} = 48 \ \Omega.$$

Each radiator can be modeled as a  $48 \ \Omega$  resistor with a voltage drop of 240 V and power of 1200 W. The total power for two radiators is thus 2400 W.

Finally, calculate the power supplied by the 240 V source. To do this, calculate the current in the voltage source,  $i_s$ , by writing a KCL equation at the top node in Fig. 2.26, and use that current to calculate the power for the voltage source.

$$-i_s + i_1 + i_2 = 0 \quad \Rightarrow \quad i_s = i_1 + i_2 = \frac{v_1}{R} + \frac{v_2}{R} = \frac{240}{48} + \frac{240}{48} = 10 \text{ A.}$$

$$P_s = -(240)(i_s) = -(240)(10) = -2400 \text{ W.}$$

Thus, the total power in the circuit is  $-2400 + 2400 = 0$ , so the power balances.

Now look at the other wiring diagram for the radiators, shown in Fig. 2.27. We know that the radiators can be modeled using  $48 \ \Omega$  resistors, which are used to turn the wiring diagram into the circuit in Fig. 2.28.

Start analyzing the circuit in Fig. 2.28 by writing a KVL equation:

$$-240 + v_x + v_y = 0 \quad \Rightarrow \quad v_x + v_y = 240.$$

Next, write a KCL equation at the node labeled a:

$$-i_x + i_y = 0 \quad \Rightarrow \quad i_x = i_y = i.$$

The current in the two resistors is the same, and we can use that current in Ohm's Law equations to replace the two unknown voltages in the KVL equation:

$$48i = 48i = 240 = 96i \quad \Rightarrow \quad i = \frac{240}{96} = 2.5 \text{ A.}$$

Use the current in the two resistors to calculate the power for the two radiators.

$$P_x = P_y = Ri^2 = (48)(2.5)^2 = 300 \text{ W.}$$

Thus, if the radiators are wired as shown in Fig. 2.27, their total power will be only 600 W. This is insufficient to heat the garage.

Therefore, the way the radiators are wired has a big impact on the amount of heat that will be supplied. When they are wired using the diagram in Fig. 2.25, 2400 W of power will be available, but when they are wired using the diagram in Fig. 2.27, only 600 W of power will be available.

*NOTE: Assess your understanding of the Practical Perspective by solving Chapter Problems 2.41–2.43.*

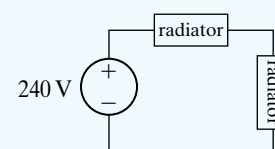


Figure 2.27 Another way to wire two radiators.

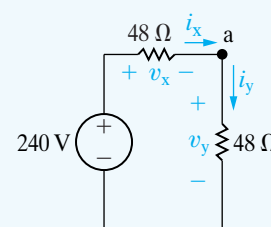


Figure 2.28 A circuit based on Fig. 2.27.

## Summary

- The circuit elements introduced in this chapter are voltage sources, current sources, and resistors:
  - An **ideal voltage source** maintains a prescribed voltage regardless of the current in the device. An **ideal current source** maintains a prescribed current regardless of the voltage across the device. Voltage and current sources are either **independent**, that is, not influenced by any other current or voltage in the circuit; or **dependent**, that is, determined by some other current or voltage in the circuit. (See pages 26 and 27.)
  - A **resistor** constrains its voltage and current to be proportional to each other. The value of the proportional constant relating voltage and current in a resistor is called its **resistance** and is measured in ohms. (See page 30.)
- Ohm's law** establishes the proportionality of voltage and current in a resistor. Specifically,

$$v = iR$$

if the current flow in the resistor is in the direction of the voltage drop across it, or

$$v = -iR$$

if the current flow in the resistor is in the direction of the voltage rise across it. (See page 31.)

- By combining the equation for power,  $p = vi$ , with Ohm's law, we can determine the power absorbed by a resistor:

$$p = i^2R = v^2/R.$$

(See page 32.)

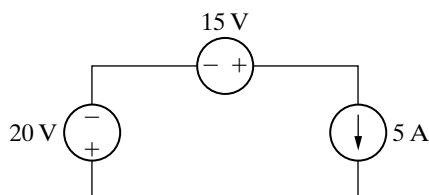
- Circuits are described by nodes and closed paths. A **node** is a point where two or more circuit elements join. When just two elements connect to form a node, they are said to be **in series**. A **closed path** is a loop traced through connecting elements, starting and ending at the same node and encountering intermediate nodes only once each. (See pages 37–39.)
- The voltages and currents of interconnected circuit elements obey Kirchhoff's laws:
  - Kirchhoff's current law** states that the algebraic sum of all the currents at any node in a circuit equals zero. (See page 37.)
  - Kirchhoff's voltage law** states that the algebraic sum of all the voltages around any closed path in a circuit equals zero. (See page 38.)
- A circuit is solved when the voltage across and the current in every element have been determined. By combining an understanding of independent and dependent sources, Ohm's law, and Kirchhoff's laws, we can solve many simple circuits.

## Problems

### Section 2.1

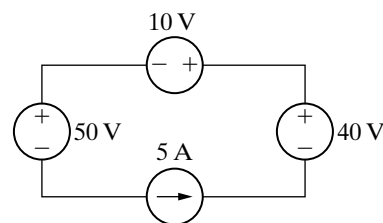
- 2.1 a) Is the interconnection of ideal sources in the circuit in Fig. P2.1 valid? Explain.
- b) Identify which sources are developing power and which sources are absorbing power.
- c) Verify that the total power developed in the circuit equals the total power absorbed.
- d) Repeat (a)–(c), reversing the polarity of the 20 V source.

Figure P2.1



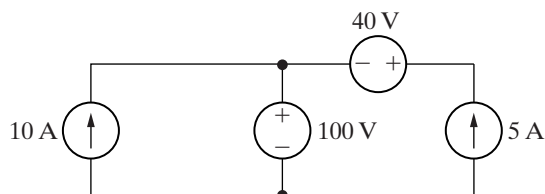
- 2.2 If the interconnection in Fig. P2.2 is valid, find the total power developed in the circuit. If the interconnection is not valid, explain why.

Figure P2.2



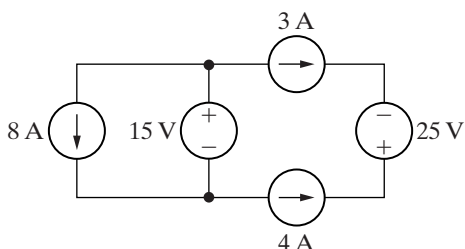
- 2.3 If the interconnection in Fig. P2.3 is valid, find the power developed by the current sources. If the interconnection is not valid, explain why.

Figure P2.3



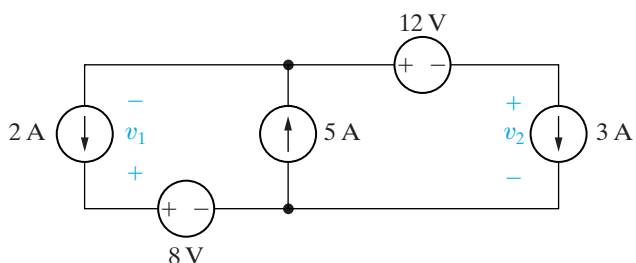
- 2.4 If the interconnection in Fig. P2.4 is valid, find the total power developed by the voltage sources. If the interconnection is not valid, explain why.

Figure P2.4



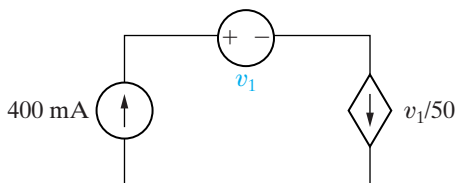
- 2.5 The interconnection of ideal sources can lead to an indeterminate solution. With this thought in mind, explain why the solutions for  $v_1$  and  $v_2$  in the circuit in Fig. P2.5 are not unique.

Figure P2.5



- 2.6 Consider the interconnection shown in Fig. P2.6.
- What value of  $v_1$  is required to make this a valid interconnection?
  - For this value of  $v_1$ , find the power associated with the voltage source.

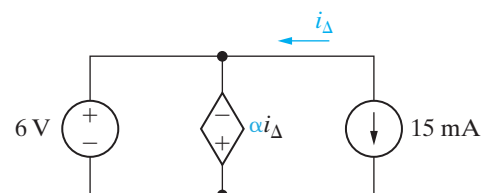
Figure P2.6



- 2.7 Consider the interconnection shown in Fig. P2.7.

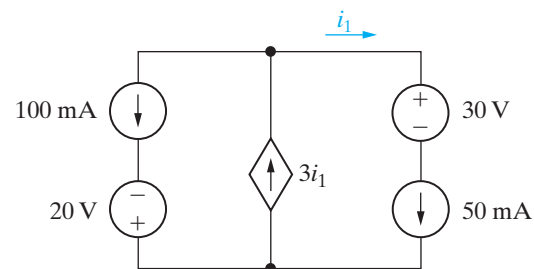
- What value of  $\alpha$  is required to make this a valid interconnection?
- For this value of  $\alpha$ , find the power associated with the current source.
- Is the current source supplying or absorbing power?

Figure P2.7



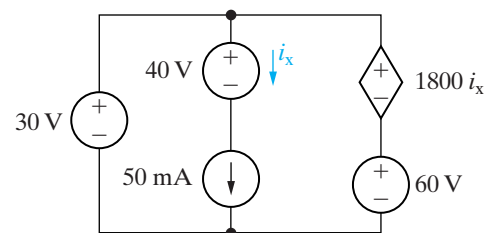
- 2.8 a) Is the interconnection in Fig. P2.8 valid? Explain.  
b) Can you find the total energy developed in the circuit? Explain.

Figure P2.8



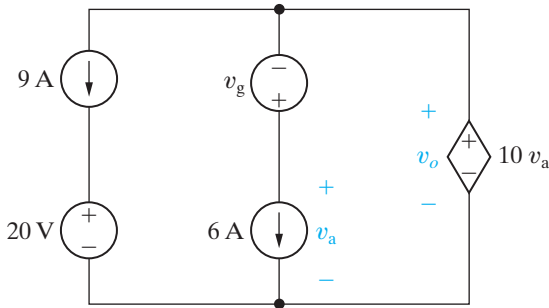
- 2.9 If the interconnection in Fig. P2.9 is valid, find the total power developed in the circuit. If the interconnection is not valid, explain why.

Figure P2.9



- 2.10 Find the total power developed in the circuit in Fig. P2.10 if  $v_o = 5$  V.

Figure P2.10

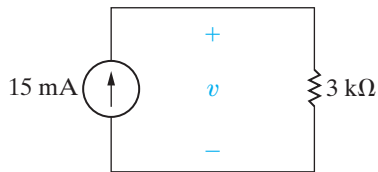


Sections 2.2–2.3

2.11 For the circuit shown in Fig. P2.11

- Find  $v$ .
- Find the power absorbed by the resistor.
- Reverse the direction of the current source and repeat parts (a) and (b).

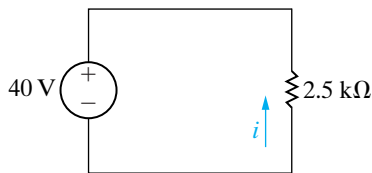
Figure P2.11



2.12 For the circuit shown in Fig. P2.12

- Find  $i$ .
- Find the power supplied by the voltage source.
- Reverse the polarity of the voltage source and repeat parts (a) and (b).

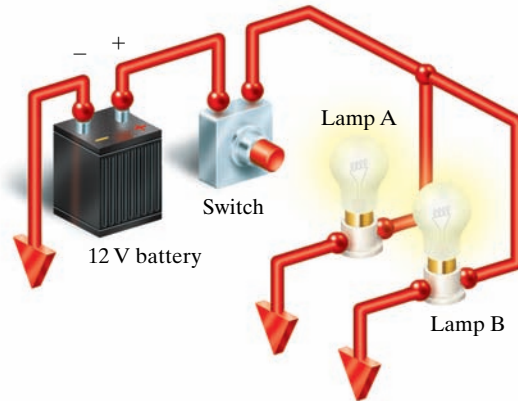
Figure P2.12



2.13 A pair of automotive headlamps is connected to a 12 V battery via the arrangement shown in Fig. P2.13. In the figure, the triangular symbol ▼ is used to indicate that the terminal is connected directly to the metal frame of the car.

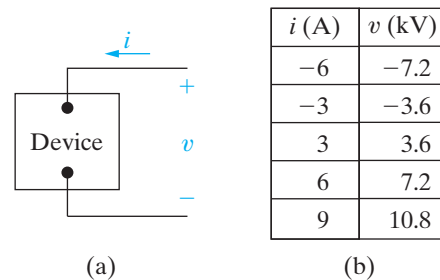
- Construct a circuit model using resistors and an independent voltage source.
- Identify the correspondence between the ideal circuit element and the symbol component that it represents.

Figure P2.13



2.14 The terminal voltage and terminal current were measured on the device shown in Fig. P2.14(a). The values of  $v$  and  $i$  are given in the table of Fig. P2.14(b). Use the values in the table to construct a circuit model for the device consisting of a single resistor from Appendix H.

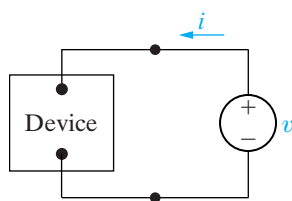
Figure P2.14



2.15 A variety of voltage source values were applied to the device shown in Fig. P2.15(a). The power absorbed by the device for each value of voltage is recorded in the table given in Fig. P2.15(b). Use the values in the table to construct a circuit model for the device consisting of a single resistor from Appendix H.



Figure P2.15



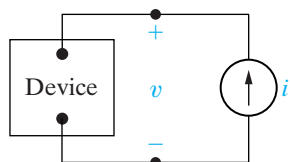
(a)

$v$ (V)	$p$ (mW)
-8	640
-4	160
4	160
8	640
12	1440
16	2560

(b)

- 2.16** A variety of current source values were applied to the device shown in Fig. P2.16(a). The power absorbed by the device for each value of current is recorded in the table given in Fig. P2.16(b). Use the values in the table to construct a circuit model for the device consisting of a single resistor from Appendix H.

Figure P2.16



(a)

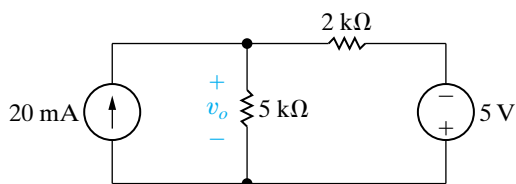
$i$ (mA)	$p$ (mW)
0.5	8.25
1.0	33.00
1.5	74.25
2.0	132.00
2.5	206.25
3.0	297.00

(b)

## Section 2.4

- 2.17** Consider the circuit shown in Fig. P2.17.
- Find  $v_o$  using Kirchoff's laws and Ohm's law.
  - Test the solution for  $v_o$  by verifying that the total power supplied equals the total power absorbed.

Figure P2.17

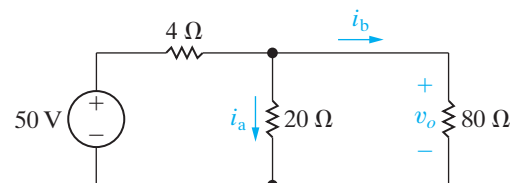


- 2.18** Given the circuit shown in Fig. P2.18, find

PSPICE  
MULTISIM

- the value of  $i_a$ ,
- the value of  $i_b$ ,
- the value of  $v_o$ ,
- the power dissipated in each resistor,
- the power delivered by the 50 V source.

Figure P2.18

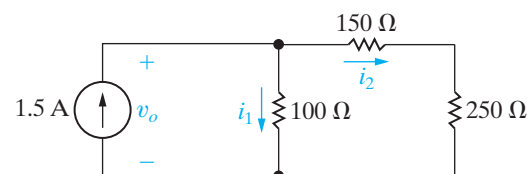


- 2.19** a) Find the currents  $i_1$  and  $i_2$  in the circuit in Fig. P2.19.

PSPICE  
MULTISIM

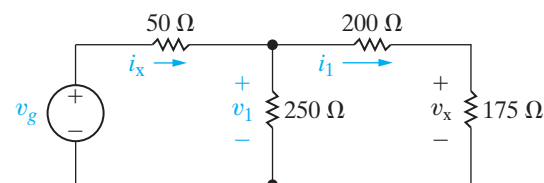
- Find the voltage  $v_o$ .
- Verify that the total power developed equals the total power dissipated.

Figure P2.19



- 2.20** The current  $i_x$  in the circuit shown in Fig. P2.20 is 50 mA and the voltage  $v_x$  is 3.5 V. Find (a)  $i_1$ ; (b)  $v_1$ ; (c)  $v_g$ ; and (d) the power supplied by the voltage source.

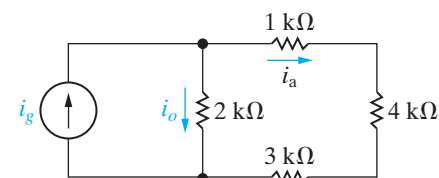
Figure P2.20



- 2.21** The current  $i_a$  in the circuit shown in Fig. P2.21 is 2 mA. Find (a)  $i_o$ ; (b)  $i_g$ ; and (c) the power delivered by the independent current source.

PSPICE  
MULTISIM

Figure P2.21



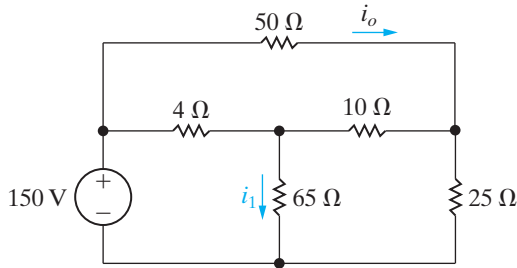
- 2.22** The current  $i_o$  in the circuit in Fig. P2.22 is 1 A.

PSPICE  
MULTISIM

- Find  $i_1$ .
- Find the power dissipated in each resistor.

- c) Verify that the total power dissipated in the circuit equals the power developed by the 150 V source.

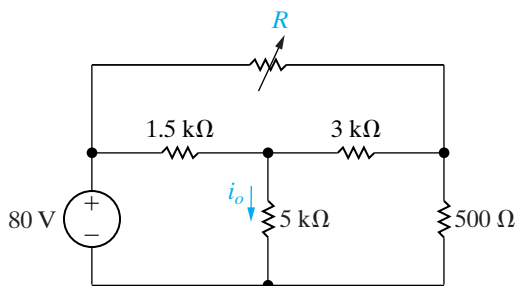
Figure P2.22



- 2.23** The variable resistor  $R$  in the circuit in Fig. P2.23 is adjusted until  $i_o$  equals 10 mA. Find the value of  $R$ .

PSPICE  
MULTISIM

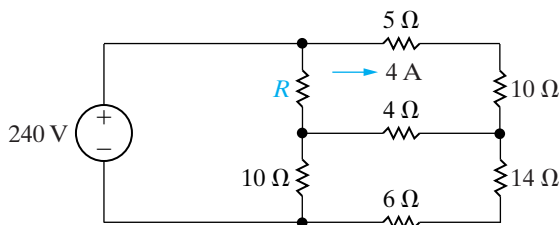
Figure P2.23



- 2.24** For the circuit shown in Fig. P2.24, find (a)  $R$  and (b) the power supplied by the 240 V source.

PSPICE  
MULTISIM

Figure P2.24

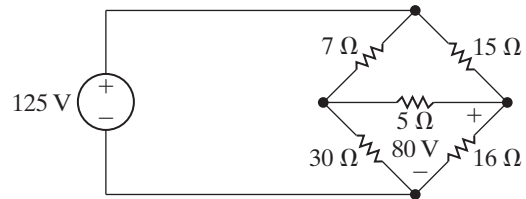


- 2.25** The voltage across the 16 Ω resistor in the circuit in Fig. P2.25 is 80 V, positive at the upper terminal.

PSPICE  
MULTISIM

- a) Find the power dissipated in each resistor.  
b) Find the power supplied by the 125 V ideal voltage source.  
c) Verify that the power supplied equals the total power dissipated.

Figure P2.25

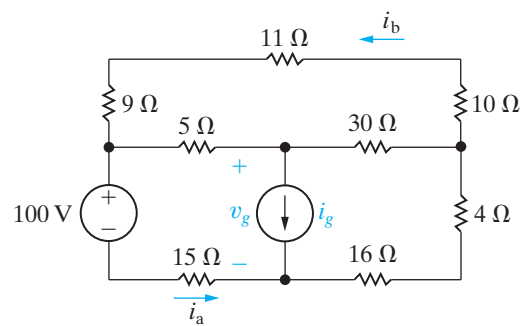


- 2.26** The currents  $i_a$  and  $i_b$  in the circuit in Fig. P2.26 are 4 A and  $-2$  A, respectively.

PSPICE  
MULTISIM

- a) Find  $i_g$ .  
b) Find the power dissipated in each resistor.  
c) Find  $v_g$ .  
d) Show that the power delivered by the current source is equal to the power absorbed by all the other elements.

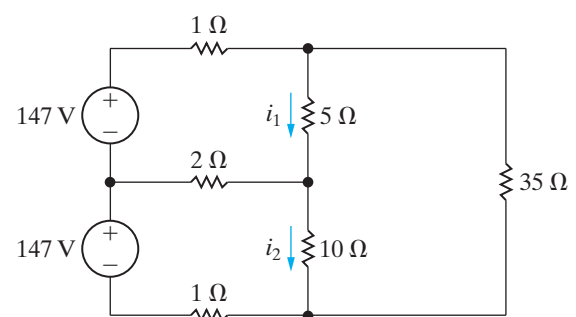
Figure P2.26



- 2.27** The currents  $i_1$  and  $i_2$  in the circuit in Fig. P2.27 are 21 A and 14 A, respectively.

- a) Find the power supplied by each voltage source.  
b) Show that the total power supplied equals the total power dissipated in the resistors.

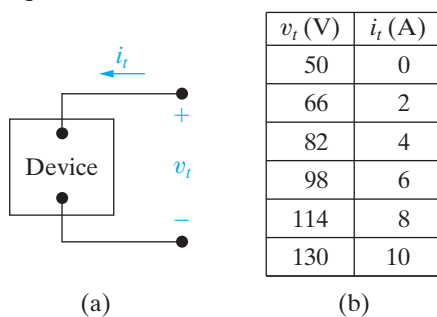
Figure P2.27



**2.28** The voltage and current were measured at the terminals of the device shown in Fig. P2.28(a). The results are tabulated in Fig. P2.28(b).

- Construct a circuit model for this device using an ideal voltage source in series with a resistor.
- Use the model to predict the value of  $i_t$  when  $v_t$  is zero.

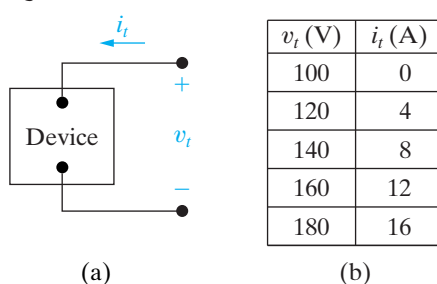
Figure P2.28



**2.29** The voltage and current were measured at the terminals of the device shown in Fig. P2.29(a). The results are tabulated in Fig. P2.29(b).

- Construct a circuit model for this device using an ideal current source in parallel with a resistor.
- Use the model to predict the amount of power the device will deliver to a  $20\ \Omega$  resistor.

Figure P2.29

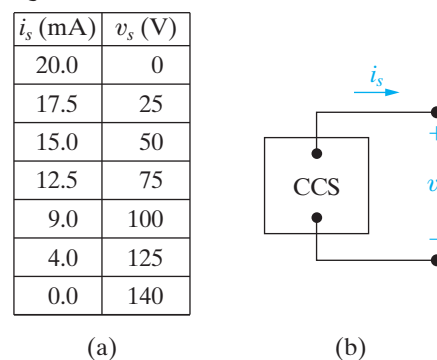


**2.30** The table in Fig. P2.30(a) gives the relationship between the terminal current and voltage of the practical constant current source shown in Fig. P2.30(b).

- Plot  $i_s$  versus  $v_s$ .
- Construct a circuit model of this current source that is valid for  $0 \leq v_s \leq 75\ \text{V}$ , based on the equation of the line plotted in (a).
- Use your circuit model to predict the current delivered to a  $2.5\ \text{k}\Omega$  resistor.
- Use your circuit model to predict the open-circuit voltage of the current source.

- What is the actual open-circuit voltage?
- Explain why the answers to (d) and (e) are not the same.

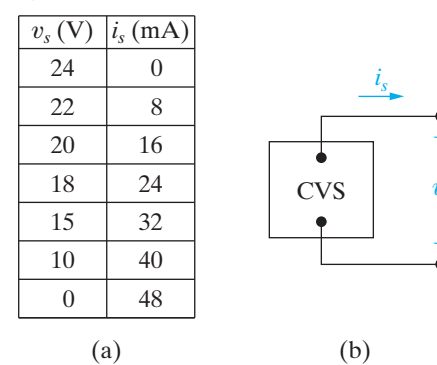
Figure P2.30



**2.31** The table in Fig. P2.31(a) gives the relationship between the terminal voltage and current of the practical constant voltage source shown in Fig. P2.31(b).

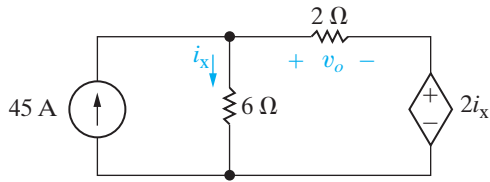
- Plot  $v_s$  versus  $i_s$ .
- Construct a circuit model of the practical source that is valid for  $0 \leq i_s \leq 24\ \text{mA}$ , based on the equation of the line plotted in (a). (Use an ideal voltage source in series with an ideal resistor.)
- Use your circuit model to predict the current delivered to a  $1\ \text{k}\Omega$  resistor connected to the terminals of the practical source.
- Use your circuit model to predict the current delivered to a short circuit connected to the terminals of the practical source.
- What is the actual short-circuit current?
- Explain why the answers to (d) and (e) are not the same.

Figure P2.31



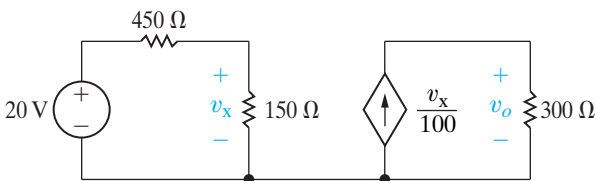
**2.32** For the circuit shown in Fig. P2.32, find  $v_o$  and the total power supplied in the circuit.

Figure P2.32



**2.33** For the circuit shown in Fig. P2.33, find  $v_o$  and the total power absorbed in the circuit.

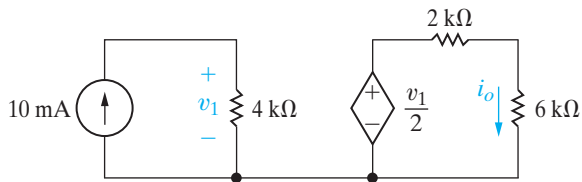
Figure P2.33



**2.34** Consider the circuit shown in Fig. P2.34.

- Find  $i_o$ .
- Verify the value of  $i_o$  by showing that the power generated in the circuit equals the power absorbed in the circuit.

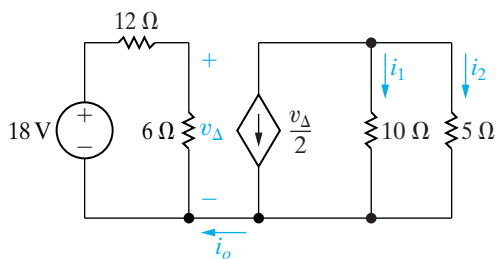
Figure P2.34



**2.35** Find (a)  $i_o$ , (b)  $i_1$ , and (c)  $i_2$  in the circuit in Fig. P2.35.

PSPICE  
MULTISIM

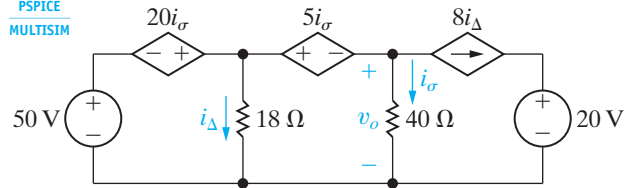
Figure P2.35



**2.36** For the circuit shown in Fig. P2.36, calculate (a)  $i_Δ$  and  $v_o$  and (b) show that the power developed equals the power absorbed.

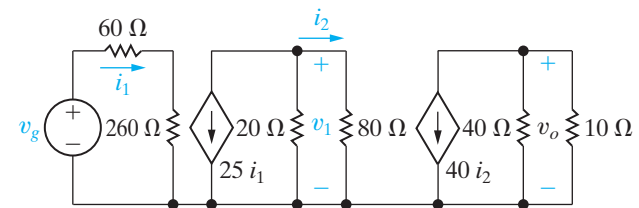
Figure P2.36

PSPICE  
MULTISIM



**2.37** Find  $v_1$  and  $v_g$  in the circuit shown in Fig. P2.37 when  $v_o$  equals 5 V. (Hint: Start at the right end of the circuit and work back toward  $v_g$ .)

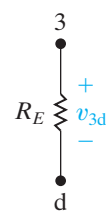
Figure P2.37



**2.38** Derive Eq. 2.25. Hint: Use Eqs. (3) and (4) from Example 2.11 to express  $i_E$  as a function of  $i_B$ . Solve Eq. (2) for  $i_2$  and substitute the result into both Eqs. (5) and (6). Solve the “new” Eq. (6) for  $i_1$  and substitute this result into the “new” Eq. (5). Replace  $i_E$  in the “new” Eq. (5) and solve for  $i_B$ . Note that because  $i_{CC}$  appears only in Eq. (1), the solution for  $i_B$  involves the manipulation of only five equations.

**2.39** For the circuit shown in Fig. 2.24,  $R_1 = 40 \text{ k}\Omega$ ,  $R_2 = 60 \text{ k}\Omega$ ,  $R_C = 750 \Omega$ ,  $R_E = 120 \Omega$ ,  $V_{CC} = 10 \text{ V}$ ,  $V_0 = 600 \text{ mV}$ , and  $\beta = 49$ . Calculate  $i_B$ ,  $i_C$ ,  $i_E$ ,  $v_{3d}$ ,  $v_{bd}$ ,  $i_2$ ,  $i_1$ ,  $v_{ab}$ ,  $i_{CC}$ , and  $v_{13}$ . (Note: In the double subscript notation on voltage variables, the first subscript is positive with respect to the second subscript. See Fig. P2.39.)

Figure P2.39



Sections 2.1–2.5

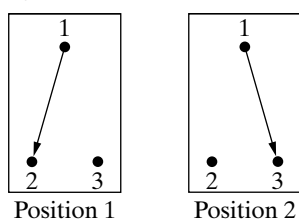
**2.40** It is often desirable in designing an electric wiring system to be able to control a single appliance from two or more locations, for example, to control a lighting fixture from both the top and bottom of a

DESIGN  
PROBLEM

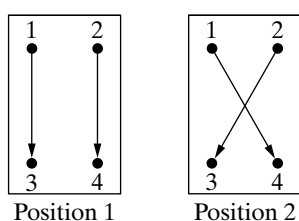
stairwell. In home wiring systems, this type of control is implemented with three-way and four-way switches. A three-way switch is a three-terminal, two-position switch, and a four-way switch is a four-terminal, two-position switch. The switches are shown schematically in Fig. P2.40(a), which illustrates a three-way switch, and P2.40(b), which illustrates a four-way switch.

- a) Show how two three-way switches can be connected between a and b in the circuit in Fig. P2.40(c) so that the lamp  $l$  can be turned ON or OFF from two locations.
- b) If the lamp (appliance) is to be controlled from more than two locations, four-way switches are used in conjunction with two three-way switches. One four-way switch is required for each location in excess of two. Show how one four-way switch plus two three-way switches can be connected between a and b in Fig. P2.40(c) to control the lamp from three locations. (*Hint:* The four-way switch is placed between the three-way switches.)

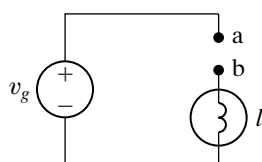
Figure P2.40



(a)



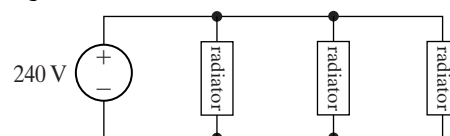
(b)



(c)

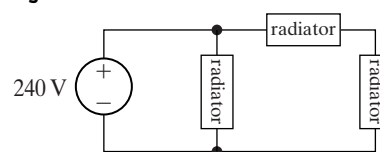
- 2.41 Suppose you want to add a third radiator to your garage that is identical to the two radiators you have already installed. All three radiators can be modeled by  $48\ \Omega$  resistors. Using the wiring diagram shown in Fig. P2.41, calculate the total power for the three radiators.

Figure P2.41



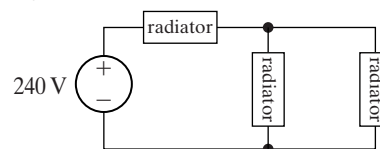
- 2.42 Repeat Problem 2.41 using the wiring diagram shown in Fig. P2.42. Compare the total radiator power in this configuration with the total radiator power in the configuration shown in Fig. P2.41.

Figure P2.42



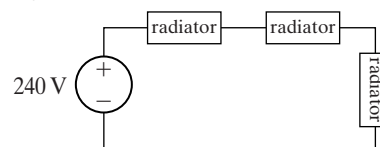
- 2.43 Repeat Problem 2.41 using the wiring diagram shown in Fig. P2.43. Compare the total radiator power in this configuration with the total radiator power in the configuration shown in Fig. P2.41.

Figure P2.43



- 2.44 Repeat Problem 2.41 using the wiring diagram shown in Fig. P2.44. Compare the total radiator power in this configuration with the total radiator power in the configuration shown in Fig. P2.41.

Figure P2.44



## CHAPTER CONTENTS

- 3.1 Resistors in Series p. 58
- 3.2 Resistors in Parallel p. 59
- 3.3 The Voltage-Divider and Current-Divider Circuits p. 61
- 3.4 Voltage Division and Current Division p. 64
- 3.5 Measuring Voltage and Current p. 66
- 3.6 Measuring Resistance—The Wheatstone Bridge p. 69
- 3.7 Delta-to-Wye (Pi-to-Tee) Equivalent Circuits p. 71

## ✓ CHAPTER OBJECTIVES

- 1 Be able to recognize resistors connected in series and in parallel and use the rules for combining series-connected resistors and parallel-connected resistors to yield equivalent resistance.
- 2 Know how to design simple voltage-divider and current-divider circuits.
- 3 Be able to use voltage division and current division appropriately to solve simple circuits.
- 4 Be able to determine the reading of an ammeter when added to a circuit to measure current; be able to determine the reading of a voltmeter when added to a circuit to measure voltage.
- 5 Understand how a Wheatstone bridge is used to measure resistance.
- 6 Know when and how to use delta-to-wye equivalent circuits to solve simple circuits.



## Simple Resistive Circuits

**Our analytical toolbox** now contains Ohm's law and Kirchhoff's laws. In Chapter 2 we used these tools in solving simple circuits. In this chapter we continue applying these tools, but on more-complex circuits. The greater complexity lies in a greater number of elements with more complicated interconnections. This chapter focuses on reducing such circuits into simpler, equivalent circuits. We continue to focus on relatively simple circuits for two reasons: (1) It gives us a chance to acquaint ourselves thoroughly with the laws underlying more sophisticated methods, and (2) it allows us to be introduced to some circuits that have important engineering applications.

The sources in the circuits discussed in this chapter are limited to voltage and current sources that generate either constant voltages or currents; that is, voltages and currents that are invariant with time. Constant sources are often called **dc sources**. The *dc* stands for *direct current*, a description that has a historical basis but can seem misleading now. Historically, a direct current was defined as a current produced by a constant voltage. Therefore, a constant voltage became known as a direct current, or dc, voltage. The use of *dc* for *constant* stuck, and the terms *dc current* and *dc voltage* are now universally accepted in science and engineering to mean constant current and constant voltage.

## Practical Perspective

### Resistive Touch Screens

Some mobile phones and tablet computers use resistive touch screens, created by applying a transparent resistive material to the glass or acrylic screens. Two screens are typically used, separated by a transparent insulating layer. The resulting touch screen can be modeled by a grid of resistors in the  $x$ -direction and a grid of resistors in the  $y$ -direction, as shown in the figure on the right.

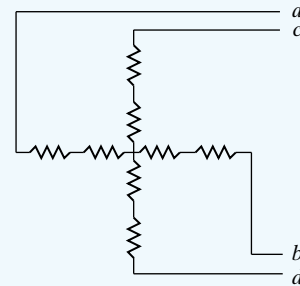
A separate electronic circuit applies a voltage drop across the grid in the  $x$ -direction, between the points  $a$  and  $b$  in the circuit, then removes that voltage and applies a voltage drop across the grid in the  $y$ -direction (between points  $c$  and  $d$ ),

and continues to repeat this process. When the screen is touched, the two resistive layers are pressed together, creating a voltage that is sensed in the  $x$ -grid and another voltage that is sensed in the  $y$ -grid. These two voltages precisely locate the point where the screen was touched.

How is the voltage created by touching the screen related to the position where the screen was touched? How are the properties of the grids used to calculate the touch position? We will answer these questions in the Practical Perspective at the end of this chapter. The circuit analysis required to answer these questions uses some circuit analysis tools developed next.



Denis Semchenko / Shutterstock





### 3.1 Resistors in Series

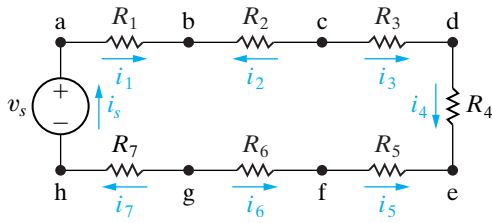


Figure 3.1 ▲ Resistors connected in series.

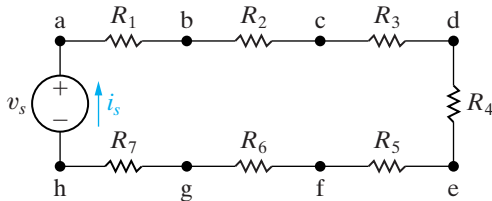


Figure 3.2 ▲ Series resistors with a single unknown current  $i_s$ .

In Chapter 2, we said that when just two elements connect at a single node, they are said to be in series. **Series-connected circuit elements** carry the same current. The resistors in the circuit shown in Fig. 3.1 are connected in series. We can show that these resistors carry the same current by applying Kirchhoff’s current law to each node in the circuit. The series interconnection in Fig. 3.1 requires that

$$i_s = i_1 = -i_2 = i_3 = i_4 = -i_5 = -i_6 = i_7, \tag{3.1}$$

which states that if we know any one of the seven currents, we know them all. Thus we can redraw Fig. 3.1 as shown in Fig. 3.2, retaining the identity of the single current  $i_s$ .

To find  $i_s$ , we apply Kirchhoff’s voltage law around the single closed loop. Defining the voltage across each resistor as a drop in the direction of  $i_s$  gives

$$-v_s + i_s R_1 + i_s R_2 + i_s R_3 + i_s R_4 + i_s R_5 + i_s R_6 + i_s R_7 = 0, \tag{3.2}$$

or

$$v_s = i_s(R_1 + R_2 + R_3 + R_4 + R_5 + R_6 + R_7). \tag{3.3}$$

The significance of Eq. 3.3 for calculating  $i_s$  is that the seven resistors can be replaced by a single resistor whose numerical value is the sum of the individual resistors, that is,

$$R_{eq} = R_1 + R_2 + R_3 + R_4 + R_5 + R_6 + R_7 \tag{3.4}$$

and

$$v_s = i_s R_{eq}. \tag{3.5}$$

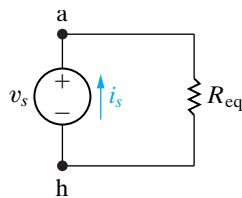


Figure 3.3 ▲ A simplified version of the circuit shown in Fig. 3.2.

Thus we can redraw Fig. 3.2 as shown in Fig. 3.3.

In general, if  $k$  resistors are connected in series, the equivalent single resistor has a resistance equal to the sum of the  $k$  resistances, or

$$R_{eq} = \sum_{i=1}^k R_i = R_1 + R_2 + \dots + R_k. \tag{3.6}$$

**Combining resistors in series ►**

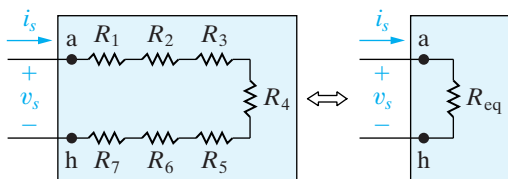


Figure 3.4 ▲ The black box equivalent of the circuit shown in Fig. 3.2.

Note that the resistance of the equivalent resistor is always larger than that of the largest resistor in the series connection.

Another way to think about this concept of an equivalent resistance is to visualize the string of resistors as being inside a black box. (An electrical engineer uses the term **black box** to imply an opaque container; that is, the contents are hidden from view. The engineer is then challenged to model the contents of the box by studying the relationship between the voltage and current at its terminals.) Determining whether the box contains  $k$  resistors or a single equivalent resistor is impossible. Figure 3.4 illustrates this method of studying the circuit shown in Fig. 3.2.

## 3.2 Resistors in Parallel

When two elements connect at a single node pair, they are said to be in parallel. **Parallel-connected circuit elements** have the same voltage across their terminals. The circuit shown in Fig. 3.5 illustrates resistors connected in parallel. Don't make the mistake of assuming that two elements are parallel connected merely because they are lined up in parallel in a circuit diagram. The defining characteristic of parallel-connected elements is that they have the same voltage across their terminals. In Fig. 3.6, you can see that  $R_1$  and  $R_3$  are not parallel connected because, between their respective terminals, another resistor dissipates some of the voltage.

Resistors in parallel can be reduced to a single equivalent resistor using Kirchhoff's current law and Ohm's law, as we now demonstrate. In the circuit shown in Fig. 3.5, we let the currents  $i_1, i_2, i_3,$  and  $i_4$  be the currents in the resistors  $R_1$  through  $R_4$ , respectively. We also let the positive reference direction for each resistor current be down through the resistor, that is, from node a to node b. From Kirchhoff's current law,

$$i_s = i_1 + i_2 + i_3 + i_4. \quad (3.7)$$

The parallel connection of the resistors means that the voltage across each resistor must be the same. Hence, from Ohm's law,

$$i_1 R_1 = i_2 R_2 = i_3 R_3 = i_4 R_4 = v_s. \quad (3.8)$$

Therefore,

$$\begin{aligned} i_1 &= \frac{v_s}{R_1}, \\ i_2 &= \frac{v_s}{R_2}, \\ i_3 &= \frac{v_s}{R_3}, \quad \text{and} \\ i_4 &= \frac{v_s}{R_4}. \end{aligned} \quad (3.9)$$

Substituting Eq. 3.9 into Eq. 3.7 yields

$$i_s = v_s \left( \frac{1}{R_1} + \frac{1}{R_2} + \frac{1}{R_3} + \frac{1}{R_4} \right), \quad (3.10)$$

from which

$$\frac{i_s}{v_s} = \frac{1}{R_{\text{eq}}} = \frac{1}{R_1} + \frac{1}{R_2} + \frac{1}{R_3} + \frac{1}{R_4}. \quad (3.11)$$

Equation 3.11 is what we set out to show: that the four resistors in the circuit shown in Fig. 3.5 can be replaced by a single equivalent resistor. The circuit shown in Fig. 3.7 illustrates the substitution. For  $k$  resistors connected in parallel, Eq. 3.11 becomes

$$\frac{1}{R_{\text{eq}}} = \sum_{i=1}^k \frac{1}{R_i} = \frac{1}{R_1} + \frac{1}{R_2} + \cdots + \frac{1}{R_k}. \quad (3.12)$$

Note that the resistance of the equivalent resistor is always smaller than the resistance of the smallest resistor in the parallel connection. Sometimes,

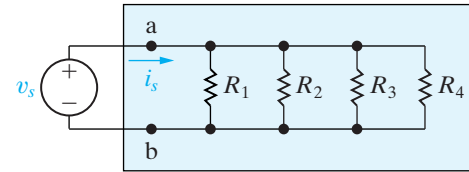


Figure 3.5 ▲ Resistors in parallel.

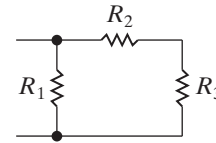


Figure 3.6 ▲ Nonparallel resistors.

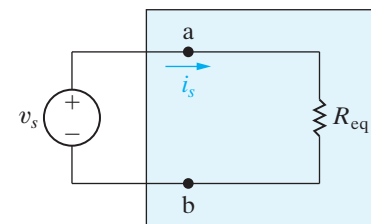


Figure 3.7 ▲ Replacing the four parallel resistors shown in Fig. 3.5 with a single equivalent resistor.

### ◀ Combining resistors in parallel

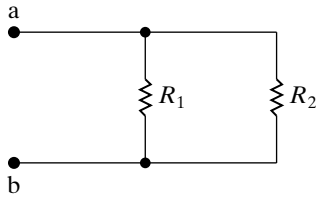


Figure 3.8 ▲ Two resistors connected in parallel.

using conductance when dealing with resistors connected in parallel is more convenient. In that case, Eq. 3.12 becomes

$$G_{\text{eq}} = \sum_{i=1}^k G_i = G_1 + G_2 + \cdots + G_k. \quad (3.13)$$

Many times only two resistors are connected in parallel. Figure 3.8 illustrates this special case. We calculate the equivalent resistance from Eq. 3.12:

$$\frac{1}{R_{\text{eq}}} = \frac{1}{R_1} + \frac{1}{R_2} = \frac{R_2 + R_1}{R_1 R_2}, \quad (3.14)$$

or

$$R_{\text{eq}} = \frac{R_1 R_2}{R_1 + R_2}. \quad (3.15)$$

Thus for just two resistors in parallel the equivalent resistance equals the product of the resistances divided by the sum of the resistances. Remember that you can only use this result in the special case of just two resistors in parallel. Example 3.1 illustrates the usefulness of these results.

### Example 3.1 Applying Series-Parallel Simplification

Find  $i_s$ ,  $i_1$ , and  $i_2$  in the circuit shown in Fig. 3.9.

#### Solution

We begin by noting that the  $3\ \Omega$  resistor is in series with the  $6\ \Omega$  resistor. We therefore replace this series combination with a  $9\ \Omega$  resistor, reducing the circuit to the one shown in Fig. 3.10(a). We now can replace the parallel combination of the  $9\ \Omega$  and  $18\ \Omega$  resistors with a single resistance of  $(18 \times 9)/(18 + 9)$ , or  $6\ \Omega$ . Figure 3.10(b) shows this further reduction of the circuit. The nodes  $x$  and  $y$  marked on all diagrams facilitate tracing through the reduction of the circuit.

From Fig. 3.10(b) you can verify that  $i_s$  equals  $120/10$ , or  $12\ \text{A}$ . Figure 3.11 shows the result at this point in the analysis. We added the voltage  $v_1$  to help clarify the subsequent discussion. Using Ohm's law we compute the value of  $v_1$ :

$$v_1 = (12)(6) = 72\ \text{V}. \quad (3.16)$$

But  $v_1$  is the voltage drop from node  $x$  to node  $y$ , so we can return to the circuit shown in Fig. 3.10(a) and again use Ohm's law to calculate  $i_1$  and  $i_2$ . Thus,

$$i_1 = \frac{v_1}{18} = \frac{72}{18} = 4\ \text{A}, \quad (3.17)$$

$$i_2 = \frac{v_1}{9} = \frac{72}{9} = 8\ \text{A}. \quad (3.18)$$

We have found the three specified currents by using series-parallel reductions in combination with Ohm's law.

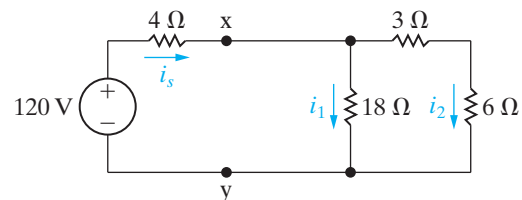


Figure 3.9 ▲ The circuit for Example 3.1.

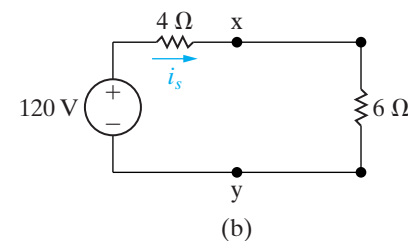
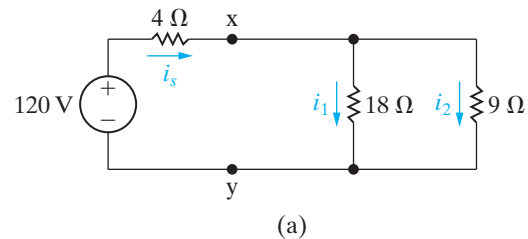


Figure 3.10 ▲ A simplification of the circuit shown in Fig. 3.9.

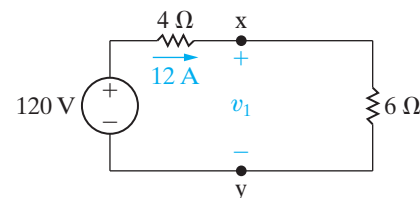


Figure 3.11 ▲ The circuit of Fig. 3.10(b) showing the numerical value of  $i_s$ .

Before leaving Example 3.1, we suggest that you take the time to show that the solution satisfies Kirchhoff's current law at every node and Kirchhoff's voltage law around every closed path. (Note that there are three closed paths that can be tested.) Showing that the power delivered by the voltage source equals the total power dissipated in the resistors also is informative. (See Problems 3.1 and 3.2.)

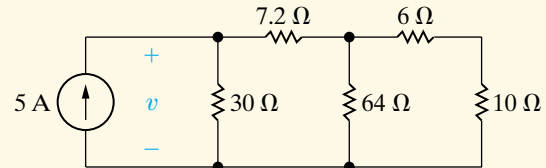
### ✓ ASSESSMENT PROBLEM

**Objective 1—Be able to recognize resistors connected in series and in parallel**

**3.1** For the circuit shown, find (a) the voltage  $v$ , (b) the power delivered to the circuit by the current source, and (c) the power dissipated in the  $10\ \Omega$  resistor.

**Answer:** (a) 60 V;  
(b) 300 W;  
(c) 57.6 W.

*NOTE:* Also try Chapter Problems 3.3–3.6.



## 3.3 The Voltage-Divider and Current-Divider Circuits

At times—especially in electronic circuits—developing more than one voltage level from a single voltage supply is necessary. One way of doing this is by using a **voltage-divider circuit**, such as the one in Fig. 3.12.

We analyze this circuit by directly applying Ohm's law and Kirchhoff's laws. To aid the analysis, we introduce the current  $i$  as shown in Fig. 3.12(b). From Kirchhoff's current law,  $R_1$  and  $R_2$  carry the same current. Applying Kirchhoff's voltage law around the closed loop yields

$$v_s = iR_1 + iR_2, \quad (3.19)$$

or

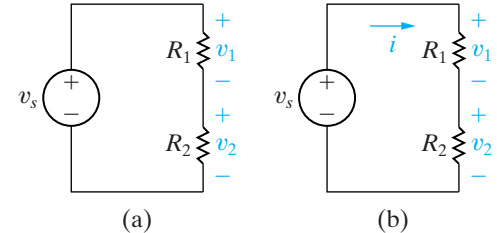
$$i = \frac{v_s}{R_1 + R_2}. \quad (3.20)$$

Now we can use Ohm's law to calculate  $v_1$  and  $v_2$ :

$$v_1 = iR_1 = v_s \frac{R_1}{R_1 + R_2}, \quad (3.21)$$

$$v_2 = iR_2 = v_s \frac{R_2}{R_1 + R_2}. \quad (3.22)$$

Equations 3.21 and 3.22 show that  $v_1$  and  $v_2$  are fractions of  $v_s$ . Each fraction is the ratio of the resistance across which the divided voltage is defined to the sum of the two resistances. Because this ratio is always less than 1.0, the divided voltages  $v_1$  and  $v_2$  are always less than the source voltage  $v_s$ .



**Figure 3.12** ▲ (a) A voltage-divider circuit and (b) the voltage-divider circuit with current  $i$  indicated.

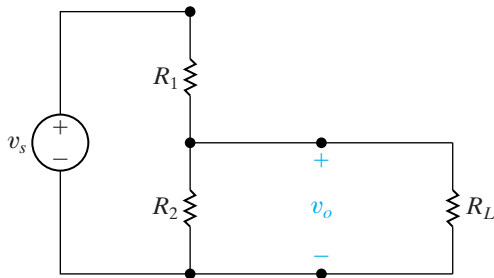


Figure 3.13 ▲ A voltage divider connected to a load  $R_L$ .

If you desire a particular value of  $v_2$ , and  $v_s$  is specified, an infinite number of combinations of  $R_1$  and  $R_2$  yield the proper ratio. For example, suppose that  $v_s$  equals 15 V and  $v_2$  is to be 5 V. Then  $v_2/v_s = \frac{1}{3}$  and, from Eq. 3.22, we find that this ratio is satisfied whenever  $R_2 = \frac{1}{2}R_1$ . Other factors that may enter into the selection of  $R_1$ , and hence  $R_2$ , include the power losses that occur in dividing the source voltage and the effects of connecting the voltage-divider circuit to other circuit components.

Consider connecting a resistor  $R_L$  in parallel with  $R_2$ , as shown in Fig. 3.13. The resistor  $R_L$  acts as a load on the voltage-divider circuit. A **load** on any circuit consists of one or more circuit elements that draw power from the circuit. With the load  $R_L$  connected, the expression for the output voltage becomes

$$v_o = \frac{R_{\text{eq}}}{R_1 + R_{\text{eq}}} v_s, \quad (3.23)$$

where

$$R_{\text{eq}} = \frac{R_2 R_L}{R_2 + R_L}. \quad (3.24)$$

Substituting Eq. 3.24 into Eq. 3.23 yields

$$v_o = \frac{R_2}{R_1[1 + (R_2/R_L)] + R_2} v_s. \quad (3.25)$$

Note that Eq. 3.25 reduces to Eq. 3.22 as  $R_L \rightarrow \infty$ , as it should. Equation 3.25 shows that, as long as  $R_L \gg R_2$ , the voltage ratio  $v_o/v_s$  is essentially undisturbed by the addition of the load on the divider.

Another characteristic of the voltage-divider circuit of interest is the sensitivity of the divider to the tolerances of the resistors. By *tolerance* we mean a range of possible values. The resistances of commercially available resistors always vary within some percentage of their stated value. Example 3.2 illustrates the effect of resistor tolerances in a voltage-divider circuit.

### Example 3.2 Analyzing the Voltage-Divider Circuit

The resistors used in the voltage-divider circuit shown in Fig. 3.14 have a tolerance of  $\pm 10\%$ . Find the maximum and minimum value of  $v_o$ .

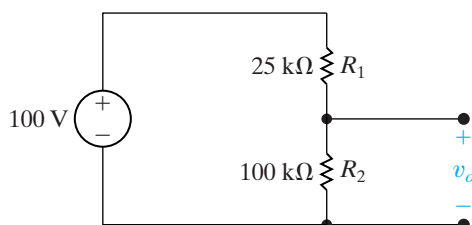


Figure 3.14 ▲ The circuit for Example 3.2.

### Solution

From Eq. 3.22, the maximum value of  $v_o$  occurs when  $R_2$  is 10% high and  $R_1$  is 10% low, and the minimum value of  $v_o$  occurs when  $R_2$  is 10% low and  $R_1$  is 10% high. Therefore

$$v_o(\text{max}) = \frac{(100)(110)}{110 + 22.5} = 83.02 \text{ V},$$

$$v_o(\text{min}) = \frac{(100)(90)}{90 + 27.5} = 76.60 \text{ V}.$$

Thus, in making the decision to use 10% resistors in this voltage divider, we recognize that the no-load output voltage will lie between 76.60 and 83.02 V.

## The Current-Divider Circuit

The **current-divider circuit** shown in Fig. 3.15 consists of two resistors connected in parallel across a current source. The current divider is designed to divide the current  $i_s$  between  $R_1$  and  $R_2$ . We find the relationship between the current  $i_s$  and the current in each resistor (that is,  $i_1$  and  $i_2$ ) by directly applying Ohm's law and Kirchoff's current law. The voltage across the parallel resistors is

$$v = i_1 R_1 = i_2 R_2 = \frac{R_1 R_2}{R_1 + R_2} i_s. \quad (3.26)$$

From Eq. 3.26,

$$i_1 = \frac{R_2}{R_1 + R_2} i_s, \quad (3.27)$$

$$i_2 = \frac{R_1}{R_1 + R_2} i_s. \quad (3.28)$$

Equations 3.27 and 3.28 show that the current divides between two resistors in parallel such that the current in one resistor equals the current entering the parallel pair multiplied by the other resistance and divided by the sum of the resistors. Example 3.3 illustrates the use of the current-divider equation.

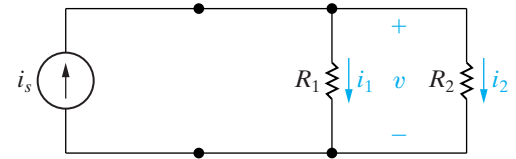


Figure 3.15 ▲ The current-divider circuit.

### Example 3.3 Analyzing a Current-Divider Circuit

Find the power dissipated in the  $6\ \Omega$  resistor shown in Fig. 3.16.

#### Solution

First, we must find the current in the resistor by simplifying the circuit with series-parallel reductions. Thus, the circuit shown in Fig. 3.16 reduces to the one shown in Fig. 3.17. We find the current  $i_o$  by using the formula for current division:

$$i_o = \frac{16}{16 + 4}(10) = 8\ \text{A}.$$

Note that  $i_o$  is the current in the  $1.6\ \Omega$  resistor in Fig. 3.16. We now can further divide  $i_o$  between the  $6\ \Omega$  and  $4\ \Omega$  resistors. The current in the  $6\ \Omega$  resistor is

$$i_6 = \frac{4}{6 + 4}(8) = 3.2\ \text{A},$$

and the power dissipated in the  $6\ \Omega$  resistor is  $p = (3.2)^2(6) = 61.44\ \text{W}$ .

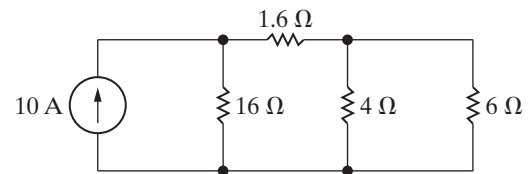


Figure 3.16 ▲ The circuit for Example 3.3.

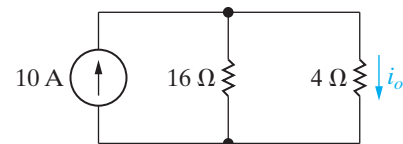
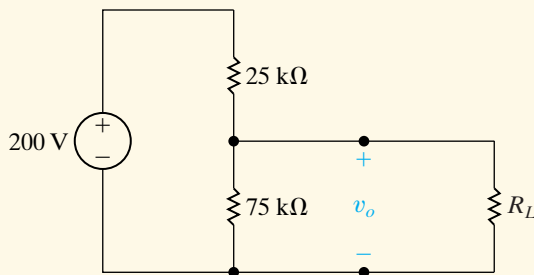


Figure 3.17 ▲ A simplification of the circuit shown in Fig. 3.16.

## ASSESSMENT PROBLEMS

**Objective 2—Know how to design simple voltage-divider and current-divider circuits**

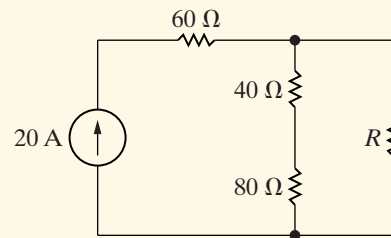
- 3.2**
- Find the no-load value of  $v_o$  in the circuit shown.
  - Find  $v_o$  when  $R_L$  is  $150\text{ k}\Omega$ .
  - How much power is dissipated in the  $25\text{ k}\Omega$  resistor if the load terminals are accidentally short-circuited?
  - What is the maximum power dissipated in the  $75\text{ k}\Omega$  resistor?



- Answer:**
- 150 V;
  - 133.33 V;
  - 1.6 W;
  - 0.3 W.

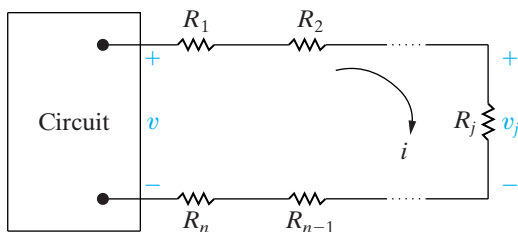
*NOTE:* Also try Chapter Problems 3.12, 3.14, and 3.16.

- 3.3**
- Find the value of  $R$  that will cause 4 A of current to flow through the  $80\text{ }\Omega$  resistor in the circuit shown.
  - How much power will the resistor  $R$  from part (a) need to dissipate?
  - How much power will the current source generate for the value of  $R$  from part (a)?



- Answer:**
- $30\text{ }\Omega$ ;
  - 7680 W;
  - 33,600 W.

## 3.4 Voltage Division and Current Division



**Figure 3.18** ▲ Circuit used to illustrate voltage division.

We can now generalize the results from analyzing the voltage divider circuit in Fig. 3.12 and the current-divider circuit in Fig. 3.15. The generalizations will yield two additional and very useful circuit analysis techniques known as **voltage division** and **current division**. Consider the circuit shown in Fig. 3.18.

The box on the left can contain a single voltage source or any other combination of basic circuit elements that results in the voltage  $v$  shown in the figure. To the right of the box are  $n$  resistors connected in series. We are interested in finding the voltage drop  $v_j$  across an arbitrary resistor  $R_j$  in terms of the voltage  $v$ . We start by using Ohm's law to calculate  $i$ , the current through all of the resistors in series, in terms of the voltage  $v$  and the  $n$  resistors:

$$i = \frac{v}{R_1 + R_2 + \cdots + R_n} = \frac{v}{R_{\text{eq}}} \quad (3.29)$$

The equivalent resistance,  $R_{\text{eq}}$ , is the sum of the  $n$  resistor values because the resistors are in series, as shown in Eq. 3.6. We apply Ohm's



law a second time to calculate the voltage drop  $v_j$  across the resistor  $R_j$ , using the current  $i$  calculated in Eq. 3.29:

$$v_j = iR_j = \frac{R_j}{R_{\text{eq}}}v. \quad (3.30) \quad \blacktriangleleft \text{Voltage-division equation}$$

Note that we used Eq. 3.29 to obtain the right-hand side of Eq. 3.30. Equation 3.30 is the voltage division equation. It says that the voltage drop  $v_j$  across a single resistor  $R_j$  from a collection of series-connected resistors is proportional to the total voltage drop  $v$  across the set of series-connected resistors. The constant of proportionality is the ratio of the single resistance to the equivalent resistance of the series connected set of resistors, or  $R_j/R_{\text{eq}}$ .

Now consider the circuit shown in Fig. 3.19. The box on the left can contain a single current source or any other combination of basic circuit elements that results in the current  $i$  shown in the figure. To the right of the box are  $n$  resistors connected in parallel. We are interested in finding the current  $i_j$  through an arbitrary resistor  $R_j$  in terms of the current  $i$ . We start by using Ohm's law to calculate  $v$ , the voltage drop across each of the resistors in parallel, in terms of the current  $i$  and the  $n$  resistors:

$$v = i(R_1 \parallel R_2 \parallel \dots \parallel R_n) = iR_{\text{eq}}. \quad (3.31)$$

The equivalent resistance of  $n$  resistors in parallel,  $R_{\text{eq}}$ , can be calculated using Eq. 3.12. We apply Ohm's law a second time to calculate the current  $i_j$  through the resistor  $R_j$ , using the voltage  $v$  calculated in Eq. 3.31:

$$i_j = \frac{v}{R_j} = \frac{R_{\text{eq}}}{R_j}i. \quad (3.32) \quad \blacktriangleleft \text{Current-division equation}$$

Note that we used Eq. 3.31 to obtain the right-hand side of Eq. 3.32. Equation 3.32 is the current division equation. It says that the current  $i$  through a single resistor  $R_j$  from a collection of parallel-connected resistors is proportional to the total current  $i$  supplied to the set of parallel-connected resistors. The constant of proportionality is the ratio of the equivalent resistance of the parallel-connected set of resistors to the single resistance, or  $R_{\text{eq}}/R_j$ . Note that the constant of proportionality in the current division equation is the inverse of the constant of proportionality in the voltage division equation!

Example 3.4 uses voltage division and current division to solve for voltages and currents in a circuit.

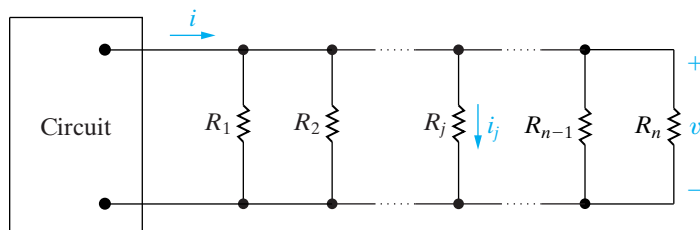


Figure 3.19  $\blacktriangle$  Circuit used to illustrate current division.

**Example 3.4** Using Voltage Division and Current Division to Solve a Circuit

Use current division to find the current  $i_o$  and use voltage division to find the voltage  $v_o$  for the circuit in Fig. 3.20.

**Solution**

We can use Eq. 3.32 if we can find the equivalent resistance of the four parallel branches containing resistors. Symbolically,

$$R_{\text{eq}} = (36 + 44) \parallel 10 \parallel (40 + 10 + 30) \parallel 24$$

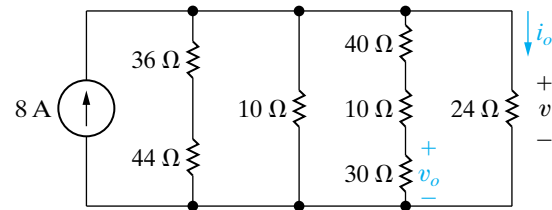
$$= 80 \parallel 10 \parallel 80 \parallel 24 = \frac{1}{\frac{1}{80} + \frac{1}{10} + \frac{1}{80} + \frac{1}{24}} = 6 \Omega.$$

Applying Eq. 3.32,

$$i_o = \frac{6}{24}(8 \text{ A}) = 2 \text{ A}.$$

We can use Ohm's law to find the voltage drop across the 24  $\Omega$  resistor:

$$v = (24)(2) = 48 \text{ V}.$$



**Figure 3.20** ▲ The circuit for Example 3.4.

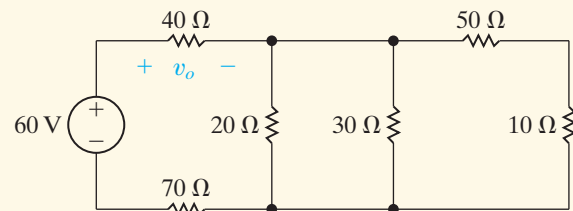
This is also the voltage drop across the branch containing the 40  $\Omega$ , the 10  $\Omega$ , and the 30  $\Omega$  resistors in series. We can then use voltage division to determine the voltage drop  $v_o$  across the 30  $\Omega$  resistor given that we know the voltage drop across the series-connected resistors, using Eq. 3.30. To do this, we recognize that the equivalent resistance of the series-connected resistors is  $40 + 10 + 30 = 80 \Omega$ :

$$v_o = \frac{30}{80}(48 \text{ V}) = 18 \text{ V}.$$

**ASSESSMENT PROBLEM**

**Objective 3**—Be able to use voltage and current division to solve simple circuits

- 3.4** a) Use voltage division to determine the voltage  $v_o$  across the 40  $\Omega$  resistor in the circuit shown.
- b) Use  $v_o$  from part (a) to determine the current through the 40  $\Omega$  resistor, and use this current and current division to calculate the current in the 30  $\Omega$  resistor.
- c) How much power is absorbed by the 50  $\Omega$  resistor?



- Answer:** (a) 20 V;  
 (b) 166.67 mA;  
 (c) 347.22 mW.

*NOTE:* Also try Chapter Problems 3.25 and 3.26.

## 3.5 Measuring Voltage and Current

When working with actual circuits, you will often need to measure voltages and currents. We will spend some time discussing several measuring devices here and in the next section, because they are relatively simple to analyze and offer practical examples of the current- and voltage-divider configurations we have just studied.

An **ammeter** is an instrument designed to measure current; it is placed in series with the circuit element whose current is being measured. A **voltmeter** is an instrument designed to measure voltage; it is placed in parallel with the element whose voltage is being measured. An ideal ammeter or voltmeter has no effect on the circuit variable it is designed to measure.

That is, an ideal ammeter has an equivalent resistance of  $0\ \Omega$  and functions as a short circuit in series with the element whose current is being measured. An ideal voltmeter has an infinite equivalent resistance and thus functions as an open circuit in parallel with the element whose voltage is being measured. The configurations for an ammeter used to measure the current in  $R_1$  and for a voltmeter used to measure the voltage in  $R_2$  are depicted in Fig. 3.21. The ideal models for these meters in the same circuit are shown in Fig. 3.22.

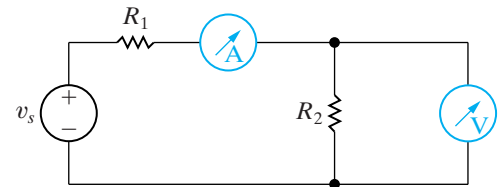
There are two broad categories of meters used to measure continuous voltages and currents: digital meters and analog meters. **Digital meters** measure the continuous voltage or current signal at discrete points in time, called the sampling times. The signal is thus converted from an analog signal, which is continuous in time, to a digital signal, which exists only at discrete instants in time. A more detailed explanation of the workings of digital meters is beyond the scope of this text and course. However, you are likely to see and use digital meters in lab settings because they offer several advantages over analog meters. They introduce less resistance into the circuit to which they are connected, they are easier to connect, and the precision of the measurement is greater due to the nature of the readout mechanism.

**Analog meters** are based on the d'Arsonval meter movement which implements the readout mechanism. A d'Arsonval meter movement consists of a movable coil placed in the field of a permanent magnet. When current flows in the coil, it creates a torque on the coil, causing it to rotate and move a pointer across a calibrated scale. By design, the deflection of the pointer is directly proportional to the current in the movable coil. The coil is characterized by both a voltage rating and a current rating. For example, one commercially available meter movement is rated at 50 mV and 1 mA. This means that when the coil is carrying 1 mA, the voltage drop across the coil is 50 mV and the pointer is deflected to its full-scale position. A schematic illustration of a d'Arsonval meter movement is shown in Fig. 3.23.

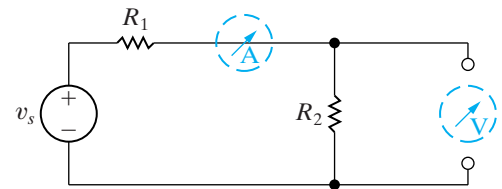
An analog ammeter consists of a d'Arsonval movement in parallel with a resistor, as shown in Fig. 3.24. The purpose of the parallel resistor is to limit the amount of current in the movement's coil by shunting some of it through  $R_A$ . An analog voltmeter consists of a d'Arsonval movement in series with a resistor, as shown in Fig. 3.25. Here, the resistor is used to limit the voltage drop across the meter's coil. In both meters, the added resistor determines the full-scale reading of the meter movement.

From these descriptions we see that an actual meter is nonideal; both the added resistor and the meter movement introduce resistance in the circuit to which the meter is attached. In fact, any instrument used to make physical measurements extracts energy from the system while making measurements. The more energy extracted by the instruments, the more severely the measurement is disturbed. A real ammeter has an equivalent resistance that is not zero, and it thus effectively adds resistance to the circuit in series with the element whose current the ammeter is reading. A real voltmeter has an equivalent resistance that is not infinite, so it effectively adds resistance to the circuit in parallel with the element whose voltage is being read.

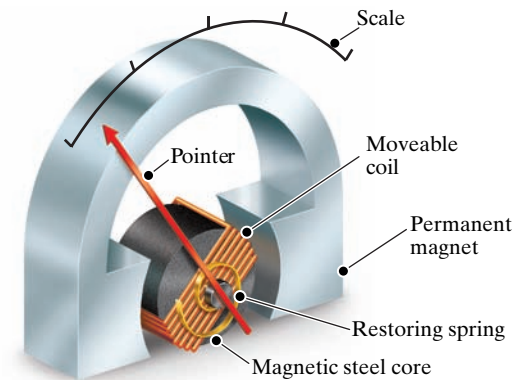
How much these meters disturb the circuit being measured depends on the effective resistance of the meters compared with the resistance in the circuit. For example, using the rule of 1/10th, the effective resistance of an ammeter should be no more than 1/10th of the value of the smallest resistance in the circuit to be sure that the current being measured is nearly the same with or without the ammeter. But in an analog meter, the value of resistance is determined by the desired full-scale reading we wish to make, and it cannot be arbitrarily selected. The following examples illustrate the calculations involved in determining the resistance needed in an analog ammeter or voltmeter. The examples also consider the resulting effective resistance of the meter when it is inserted in a circuit.



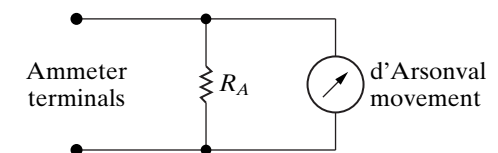
**Figure 3.21** ▲ An ammeter connected to measure the current in  $R_1$ , and a voltmeter connected to measure the voltage across  $R_2$ .



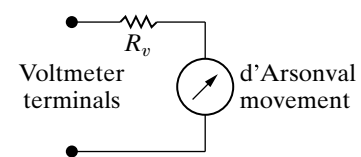
**Figure 3.22** ▲ A short-circuit model for the ideal ammeter, and an open-circuit model for the ideal voltmeter.



**Figure 3.23** ▲ A schematic diagram of a d'Arsonval meter movement.



**Figure 3.24** ▲ A dc ammeter circuit.



**Figure 3.25** ▲ A dc voltmeter circuit.

**Example 3.5 Using a d'Arsonval Ammeter**

- a) A 50 mV, 1 mA d'Arsonval movement is to be used in an ammeter with a full-scale reading of 10 mA. Determine  $R_A$ .
- b) Repeat (a) for a full-scale reading of 1 A.
- c) How much resistance is added to the circuit when the 10 mA ammeter is inserted to measure current?
- d) Repeat (c) for the 1 A ammeter.

**Solution**

- a) From the statement of the problem, we know that when the current at the terminals of the ammeter is 10 mA, 1 mA is flowing through the meter coil, which means that 9 mA must be diverted through  $R_A$ . We also know that when the movement carries 1 mA, the drop across its terminals is 50 mV. Ohm's law requires that

$$9 \times 10^{-3} R_A = 50 \times 10^{-3},$$

or

$$R_A = 50/9 = 5.555 \Omega.$$

- b) When the full-scale deflection of the ammeter is 1 A,  $R_A$  must carry 999 mA when the movement carries 1 mA. In this case, then,

$$999 \times 10^{-3} R_A = 50 \times 10^{-3},$$

or

$$R_A = 50/999 \approx 50.05 \text{ m}\Omega.$$

- c) Let  $R_m$  represent the equivalent resistance of the ammeter. For the 10 mA ammeter,

$$R_m = \frac{50 \text{ mV}}{10 \text{ mA}} = 5 \Omega,$$

or, alternatively,

$$R_m = \frac{(50)(50/9)}{50 + (50/9)} = 5 \Omega.$$

- d) For the 1 A ammeter

$$R_m = \frac{50 \text{ mV}}{1 \text{ A}} = 0.050 \Omega,$$

or, alternatively,

$$R_m = \frac{(50)(50/999)}{50 + (50/999)} = 0.050 \Omega.$$

**Example 3.6 Using a d'Arsonval Voltmeter**

- a) A 50 mV, 1 mA d'Arsonval movement is to be used in a voltmeter in which the full-scale reading is 150 V. Determine  $R_v$ .
- b) Repeat (a) for a full-scale reading of 5 V.
- c) How much resistance does the 150 V meter insert into the circuit?
- d) Repeat (c) for the 5 V meter.

**Solution**

- a) Full-scale deflection requires 50 mV across the meter movement, and the movement has a resistance of 50  $\Omega$ . Therefore we apply Eq. 3.22 with  $R_1 = R_v$ ,  $R_2 = 50$ ,  $v_s = 150$ , and  $v_2 = 50$  mV:

$$50 \times 10^{-3} = \frac{50}{R_v + 50}(150).$$

Solving for  $R_v$  gives

$$R_v = 149,950 \Omega.$$

- b) For a full-scale reading of 5 V,

$$50 \times 10^{-3} = \frac{50}{R_v + 50}(5),$$

or

$$R_v = 4950 \Omega.$$

- c) If we let  $R_m$  represent the equivalent resistance of the meter,

$$R_m = \frac{150 \text{ V}}{10^{-3} \text{ A}} = 150,000 \Omega,$$

or, alternatively,

$$R_m = 149,950 + 50 = 150,000 \Omega.$$

- d) Then,

$$R_m = \frac{5 \text{ V}}{10^{-3} \text{ A}} = 5000 \Omega,$$

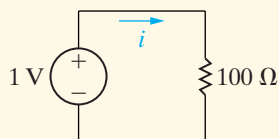
or, alternatively,

$$R_m = 4950 + 50 = 5000 \Omega.$$

## ASSESSMENT PROBLEMS

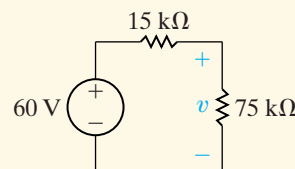
**Objective 4**—Be able to determine the reading of ammeters and voltmeters

- 3.5** a) Find the current in the circuit shown.  
b) If the ammeter in Example 3.5(a) is used to measure the current, what will it read?



**Answer:** (a) 10 mA;  
(b) 9.524 mA.

- 3.6** a) Find the voltage  $v$  across the 75 kΩ resistor in the circuit shown.  
b) If the 150 V voltmeter of Example 3.6(a) is used to measure the voltage, what will be the reading?



**Answer:** (a) 50 V;  
(b) 46.15 V.

*NOTE:* Also try Chapter Problems 3.34 and 3.37.

## 3.6 Measuring Resistance—The Wheatstone Bridge

Many different circuit configurations are used to measure resistance. Here we will focus on just one, the Wheatstone bridge. The Wheatstone bridge circuit is used to precisely measure resistances of medium values, that is, in the range of 1 Ω to 1 MΩ. In commercial models of the Wheatstone bridge, accuracies on the order of  $\pm 0.1\%$  are possible. The bridge circuit consists of four resistors, a dc voltage source, and a detector. The resistance of one of the four resistors can be varied, which is indicated in Fig. 3.26 by the arrow through  $R_3$ . The dc voltage source is usually a battery, which is indicated by the battery symbol for the voltage source  $v$  in Fig. 3.26. The detector is generally a d'Arsonval movement in the microamp range and is called a galvanometer. Figure 3.26 shows the circuit arrangement of the resistances, battery, and detector where  $R_1$ ,  $R_2$ , and  $R_3$  are known resistors and  $R_x$  is the unknown resistor.

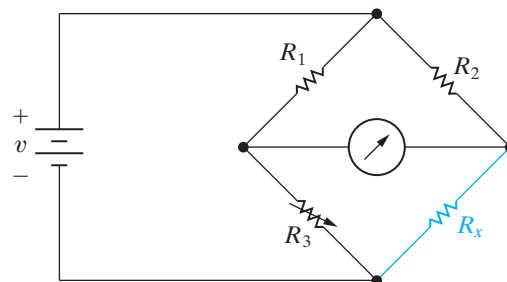
To find the value of  $R_x$ , we adjust the variable resistor  $R_3$  until there is no current in the galvanometer. We then calculate the unknown resistor from the simple expression

$$R_x = \frac{R_2}{R_1} R_3. \quad (3.33)$$

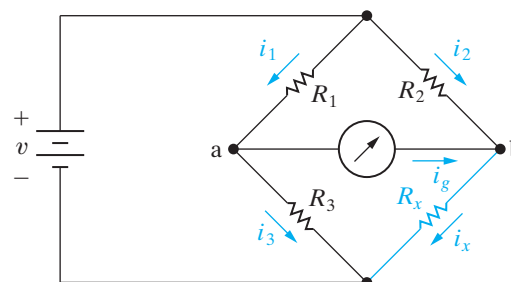
The derivation of Eq. 3.33 follows directly from the application of Kirchhoff's laws to the bridge circuit. We redraw the bridge circuit as Fig. 3.27 to show the currents appropriate to the derivation of Eq. 3.33. When  $i_g$  is zero, that is, when the bridge is balanced, Kirchhoff's current law requires that

$$i_1 = i_3, \quad (3.34)$$

$$i_2 = i_x. \quad (3.35)$$



**Figure 3.26** ▲ The Wheatstone bridge circuit.



**Figure 3.27** ▲ A balanced Wheatstone bridge ( $i_g = 0$ ).

Now, because  $i_g$  is zero, there is no voltage drop across the detector, and therefore points a and b are at the same potential. Thus when the bridge is balanced, Kirchhoff's voltage law requires that

$$i_3 R_3 = i_x R_x, \quad (3.36)$$

$$i_1 R_1 = i_2 R_2. \quad (3.37)$$

Combining Eqs. 3.34 and 3.35 with Eq. 3.36 gives

$$i_1 R_3 = i_2 R_x. \quad (3.38)$$

We obtain Eq. 3.33 by first dividing Eq. 3.38 by Eq. 3.37 and then solving the resulting expression for  $R_x$ :

$$\frac{R_3}{R_1} = \frac{R_x}{R_2}, \quad (3.39)$$

from which

$$R_x = \frac{R_2}{R_1} R_3. \quad (3.40)$$

Now that we have verified the validity of Eq. 3.33, several comments about the result are in order. First, note that if the ratio  $R_2/R_1$  is unity, the unknown resistor  $R_x$  equals  $R_3$ . In this case, the bridge resistor  $R_3$  must vary over a range that includes the value  $R_x$ . For example, if the unknown resistance were  $1000 \Omega$  and  $R_3$  could be varied from 0 to  $100 \Omega$ , the bridge could never be balanced. Thus to cover a wide range of unknown resistors, we must be able to vary the ratio  $R_2/R_1$ . In a commercial Wheatstone bridge,  $R_1$  and  $R_2$  consist of decimal values of resistances that can be switched into the bridge circuit. Normally, the decimal values are 1, 10, 100, and  $1000 \Omega$  so that the ratio  $R_2/R_1$  can be varied from 0.001 to 1000 in decimal steps. The variable resistor  $R_3$  is usually adjustable in integral values of resistance from 1 to  $11,000 \Omega$ .

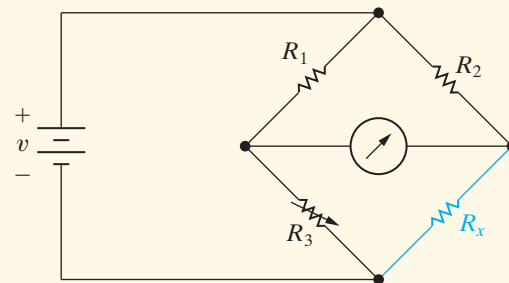
Although Eq. 3.33 implies that  $R_x$  can vary from zero to infinity, the practical range of  $R_x$  is approximately  $1 \Omega$  to  $1 \text{ M}\Omega$ . Lower resistances are difficult to measure on a standard Wheatstone bridge because of thermoelectric voltages generated at the junctions of dissimilar metals and because of thermal heating effects—that is,  $i^2 R$  effects. Higher resistances are difficult to measure accurately because of leakage currents. In other words, if  $R_x$  is large, the current leakage in the electrical insulation may be comparable to the current in the branches of the bridge circuit.

## ASSESSMENT PROBLEM

### Objective 5—Understand how a Wheatstone bridge is used to measure resistance

3.7 The bridge circuit shown is balanced when  $R_1 = 100 \Omega$ ,  $R_2 = 1000 \Omega$ , and  $R_3 = 150 \Omega$ . The bridge is energized from a 5 V dc source.

- What is the value of  $R_x$ ?
- Suppose each bridge resistor is capable of dissipating 250 mW. Can the bridge be left in the balanced state without exceeding the power-dissipating capacity of the resistors, thereby damaging the bridge?



**Answer:** (a)  $1500 \Omega$ ;  
(b) yes.

*NOTE:* Also try Chapter Problem 3.51.



### 3.7 Delta-to-Wye (Pi-to-Tee) Equivalent Circuits

The bridge configuration in Fig. 3.26 introduces an interconnection of resistances that warrants further discussion. If we replace the galvanometer with its equivalent resistance  $R_m$ , we can draw the circuit shown in Fig. 3.28. We cannot reduce the interconnected resistors of this circuit to a single equivalent resistance across the terminals of the battery if restricted to the simple series or parallel equivalent circuits introduced earlier in this chapter. The interconnected resistors can be reduced to a single equivalent resistor by means of a delta-to-wye ( $\Delta$ -to-Y) or pi-to-tee ( $\pi$ -to-T) equivalent circuit.<sup>1</sup>

The resistors  $R_1$ ,  $R_2$ , and  $R_m$  (or  $R_3$ ,  $R_m$  and  $R_x$ ) in the circuit shown in Fig. 3.28 are referred to as a **delta ( $\Delta$ ) interconnection** because the interconnection looks like the Greek letter  $\Delta$ . It also is referred to as a **pi interconnection** because the  $\Delta$  can be shaped into a  $\pi$  without disturbing the electrical equivalence of the two configurations. The electrical equivalence between the  $\Delta$  and  $\pi$  interconnections is apparent in Fig. 3.29.

The resistors  $R_1$ ,  $R_m$ , and  $R_3$  (or  $R_2$ ,  $R_m$  and  $R_x$ ) in the circuit shown in Fig. 3.28 are referred to as a **wye (Y) interconnection** because the interconnection can be shaped to look like the letter Y. It is easier to see the Y shape when the interconnection is drawn as in Fig. 3.30. The Y configuration also is referred to as a **tee (T) interconnection** because the Y structure can be shaped into a T structure without disturbing the electrical equivalence of the two structures. The electrical equivalence of the Y and the T configurations is apparent from Fig. 3.30.

Figure 3.31 illustrates the  $\Delta$ -to-Y (or  $\pi$ -to-T) equivalent circuit transformation. Note that we cannot transform the  $\Delta$  interconnection into the Y interconnection simply by changing the shape of the interconnections. Saying the  $\Delta$ -connected circuit is equivalent to the Y-connected circuit means that the  $\Delta$  configuration can be replaced with a Y configuration to make the terminal behavior of the two configurations identical. Thus if each circuit is placed in a black box, we can't tell by external measurements whether the box contains a set of  $\Delta$ -connected resistors or a set of Y-connected resistors. This condition is true only if the resistance between corresponding terminal pairs is the same for each box. For example, the resistance between terminals a and b must be the same whether we use the  $\Delta$ -connected set or the Y-connected set. For each pair of terminals in the  $\Delta$ -connected circuit, the equivalent resistance can be computed using series and parallel simplifications to yield

$$R_{ab} = \frac{R_c(R_a + R_b)}{R_a + R_b + R_c} = R_1 + R_2, \tag{3.41}$$

$$R_{bc} = \frac{R_a(R_b + R_c)}{R_a + R_b + R_c} = R_2 + R_3, \tag{3.42}$$

$$R_{ca} = \frac{R_b(R_c + R_a)}{R_a + R_b + R_c} = R_1 + R_3. \tag{3.43}$$

<sup>1</sup>  $\Delta$  and Y structures are present in a variety of useful circuits, not just resistive networks. Hence the  $\Delta$ -to-Y transformation is a helpful tool in circuit analysis.

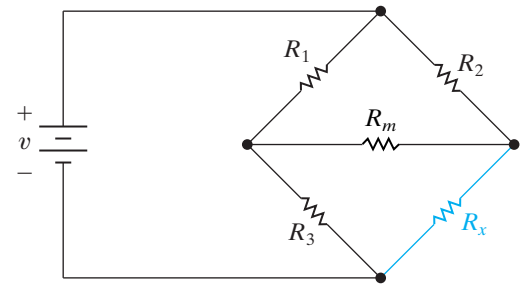


Figure 3.28 ▲ A resistive network generated by a Wheatstone bridge circuit.

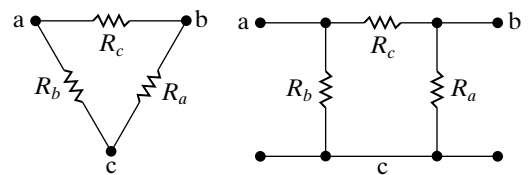


Figure 3.29 ▲ A  $\Delta$  configuration viewed as a  $\pi$  configuration.

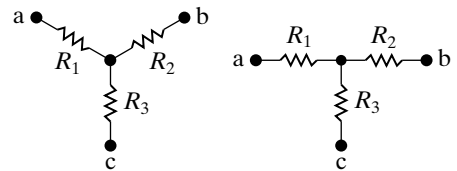


Figure 3.30 ▲ A Y structure viewed as a T structure.

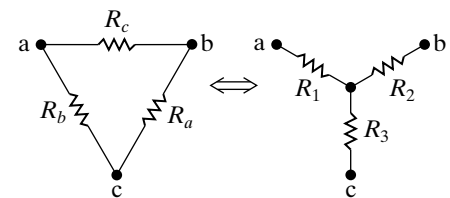


Figure 3.31 ▲ The  $\Delta$ -to-Y transformation.



Straightforward algebraic manipulation of Eqs. 3.41–3.43 gives values for the Y-connected resistors in terms of the  $\Delta$ -connected resistors required for the  $\Delta$ -to-Y equivalent circuit:

$$R_1 = \frac{R_b R_c}{R_a + R_b + R_c}, \quad (3.44)$$

$$R_2 = \frac{R_c R_a}{R_a + R_b + R_c}, \quad (3.45)$$

$$R_3 = \frac{R_a R_b}{R_a + R_b + R_c}. \quad (3.46)$$

Reversing the  $\Delta$ -to-Y transformation also is possible. That is, we can start with the Y structure and replace it with an equivalent  $\Delta$  structure. The expressions for the three  $\Delta$ -connected resistors as functions of the three Y-connected resistors are

$$R_a = \frac{R_1 R_2 + R_2 R_3 + R_3 R_1}{R_1}, \quad (3.47)$$

$$R_b = \frac{R_1 R_2 + R_2 R_3 + R_3 R_1}{R_2}, \quad (3.48)$$

$$R_c = \frac{R_1 R_2 + R_2 R_3 + R_3 R_1}{R_3}. \quad (3.49)$$

Example 3.7 illustrates the use of a  $\Delta$ -to-Y transformation to simplify the analysis of a circuit.

### Example 3.7 Applying a Delta-to-Wye Transform

Find the current and power supplied by the 40 V source in the circuit shown in Fig. 3.32.

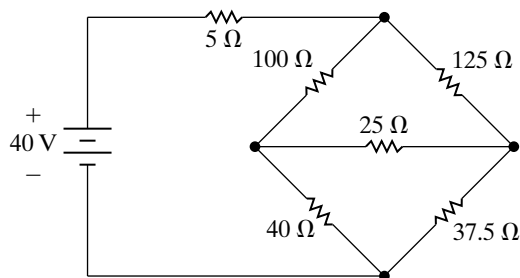


Figure 3.32 ▲ The circuit for Example 3.7.

### Solution

We are interested only in the current and power drain on the 40 V source, so the problem has been solved once we obtain the equivalent resistance across the terminals of the source. We can find this equivalent resistance easily after replacing either the upper  $\Delta$  (100, 125, 25  $\Omega$ ) or the lower  $\Delta$  (100, 25, 37.5  $\Omega$ ) with its equivalent Y. We choose to replace the upper  $\Delta$ . We then compute the three

Y resistances, defined in Fig. 3.33, from Eqs. 3.44 to 3.46. Thus,

$$R_1 = \frac{100 \times 125}{250} = 50 \Omega,$$

$$R_2 = \frac{125 \times 25}{250} = 12.5 \Omega,$$

$$R_3 = \frac{100 \times 25}{250} = 10 \Omega.$$

Substituting the Y-resistors into the circuit shown in Fig. 3.32 produces the circuit shown in Fig. 3.34. From Fig. 3.34, we can easily calculate the resistance across the terminals of the 40 V source by series-parallel simplifications:

$$R_{\text{eq}} = 55 + \frac{(50)(50)}{100} = 80 \Omega.$$

The final step is to note that the circuit reduces to an 80  $\Omega$  resistor across a 40 V source, as shown in Fig. 3.35, from which it is apparent that the 40 V source delivers 0.5 A and 20 W to the circuit.

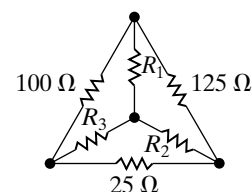
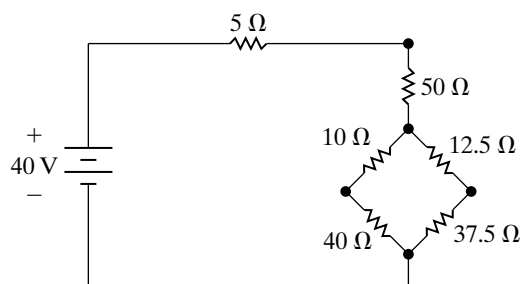
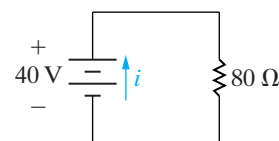


Figure 3.33 ▲ The equivalent Y resistors.



**Figure 3.34** ▲ A transformed version of the circuit shown in Fig. 3.32.



**Figure 3.35** ▲ The final step in the simplification of the circuit shown in Fig. 3.32.

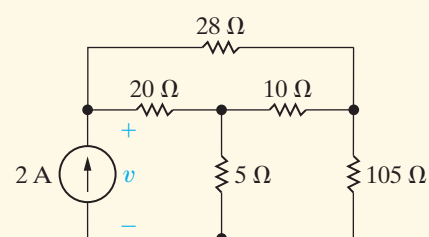
## ASSESSMENT PROBLEM

### Objective 6—Know when and how to use delta-to-wye equivalent circuits

- 3.8 Use a Y-to- $\Delta$  transformation to find the voltage  $v$  in the circuit shown.

**Answer:** 35 V.

*NOTE:* Also try Chapter Problems 3.60, 3.62, and 3.63.



## Practical Perspective

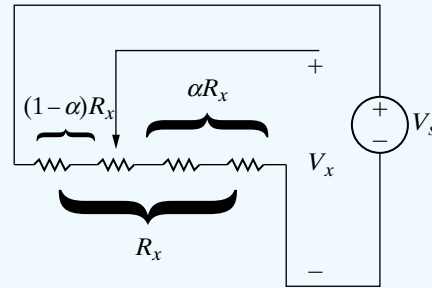
### Resistive Touch Screens

Begin by analyzing the resistive grid in the  $x$ -direction. We model the resistance of the grid in the  $x$ -direction with the resistance  $R_x$ , as shown in Fig. 3.34. The  $x$ -location where the screen is touched is indicated by the arrow. The resulting voltage drop across the resistance  $\alpha R_x$  is  $V_x$ . Touching the screen effectively divides the total resistance,  $R_x$ , into two separate resistances  $\alpha R_x$  and  $(1 - \alpha)R_x$ .

From the figure you can see that when the touch is on the far right side of the screen,  $\alpha = 0$ , and  $V_x = 0$ . Similarly, when the touch is on the far left side of the screen,  $\alpha = 1$ , and  $V_x = V_s$ . If the touch is in between the two edges of the screen, the value of  $\alpha$  is between 0 and 1 and the two parts of the resistance  $R_x$  form a voltage divider. We can calculate the voltage  $V_x$  using the equation for voltage division:

$$V_x = \frac{\alpha R_x}{\alpha R_x + (1 - \alpha)R_x} V_s = \frac{\alpha R_x}{R_x} V_s = \alpha V_s.$$

We can find the value of  $\alpha$ , which represents the location of the touch point with respect to the far right side of the screen, by dividing the voltage

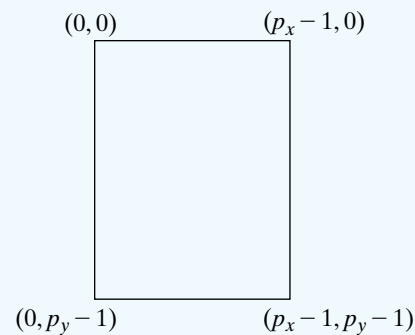


**Figure 3.36** ▲ The resistive touch screen grid in the  $x$ -direction.

across the grid resistance starting at the touch point,  $V_x$ , by the voltage applied across the entire resistive grid in the  $x$ -direction,  $V_s$ :

$$\alpha = \frac{V_x}{V_s}.$$

Now we want to use the value of  $\alpha$  to determine the  $x$ -coordinate of the touch location on the screen. Typically the screen coordinates are specified in terms of pixels (short for “picture elements”). For example, the screen of a mobile phone would be divided into a grid of pixels with  $p_x$  pixels in the  $x$ -direction, and  $p_y$  pixels in the  $y$ -direction. Each pixel is identified by its  $x$ -location (a number between 0 and  $p_x - 1$ ) and its  $y$ -location (a number between 0 and  $p_y - 1$ ). The pixel with the location  $(0, 0)$  is in the upper left hand corner of the screen, as shown in Fig. 3.37.



**Figure 3.37** ▲ The pixel coordinates of a screen with  $p_x$  pixels in the  $x$ -direction and  $p_y$  pixels in the  $y$ -direction.

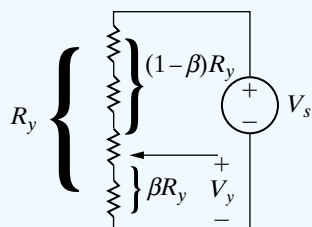
Since  $\alpha$  represents the location of the touch point with respect to the right side of the screen,  $(1 - \alpha)$  represents the location of the touch point with respect to the left side of the screen. Therefore, the  $x$ -coordinate of the pixel corresponding to the touch point is

$$x = (1 - \alpha)p_x.$$

Note that the value of  $x$  is capped at  $(p_x - 1)$ .

Using the model of the resistive screen grid in the  $y$ -direction shown in Fig. 3.38, it is easy to show that the voltage created by a touch at the arrow is given by

$$V_y = \beta V_s.$$



**Figure 3.38** ▲ The resistive touch screen grid in the  $y$ -direction.

Therefore, the  $y$ -coordinate of the pixel corresponding to the touch point is

$$y = (1 - \beta)p_y,$$

where the value of  $y$  is capped at  $(p_y - 1)$ . (See Problem 3.72.)

*NOTE: Assess your understanding of the Practical Perspective by solving Chapter Problems 3.72–3.75.*

## Summary

- **Series resistors** can be combined to obtain a single equivalent resistance according to the equation

$$R_{\text{eq}} = \sum_{i=1}^k R_i = R_1 + R_2 + \dots + R_k.$$

(See page 58.)

- **Parallel resistors** can be combined to obtain a single equivalent resistance according to the equation

$$\frac{1}{R_{\text{eq}}} = \sum_{i=1}^k \frac{1}{R_i} = \frac{1}{R_1} + \frac{1}{R_2} + \dots + \frac{1}{R_k}.$$

When just two resistors are in parallel, the equation for equivalent resistance can be simplified to give

$$R_{\text{eq}} = \frac{R_1 R_2}{R_1 + R_2}.$$

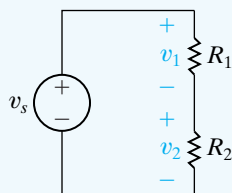
(See pages 59–60.)

- When voltage is divided between series resistors, as shown in the figure, the voltage across each resistor can be found according to the equations

$$v_1 = \frac{R_1}{R_1 + R_2} v_s,$$

$$v_2 = \frac{R_2}{R_1 + R_2} v_s.$$

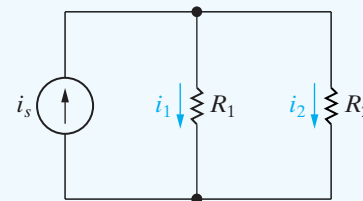
(See page 61.)



- When current is divided between parallel resistors, as shown in the figure, the current through each resistor can be found according to the equations

$$i_1 = \frac{R_2}{R_1 + R_2} i_s.$$

$$i_2 = \frac{R_1}{R_1 + R_2} i_s.$$



(See page 63.)

- **Voltage division** is a circuit analysis tool that is used to find the voltage drop across a single resistance from a collection of series-connected resistances when the voltage drop across the collection is known:

$$v_j = \frac{R_j}{R_{\text{eq}}} v,$$

where  $v_j$  is the voltage drop across the resistance  $R_j$  and  $v$  is the voltage drop across the series-connected resistances whose equivalent resistance is  $R_{\text{eq}}$ . (See page 65.)

- **Current division** is a circuit analysis tool that is used to find the current through a single resistance from a collection of parallel-connected resistances when the current into the collection is known:

$$I_j = \frac{R_{\text{eq}}}{R_j} i,$$

where  $i_j$  is the current through the resistance  $R_j$  and  $i$  is the current into the parallel-connected resistances whose equivalent resistance is  $R_{eq}$ . (See page 65.)

- A **voltmeter** measures voltage and must be placed in parallel with the voltage being measured. An ideal voltmeter has infinite internal resistance and thus does not alter the voltage being measured. (See page 66.)
- An **ammeter** measures current and must be placed in series with the current being measured. An ideal ammeter has zero internal resistance and thus does not alter the current being measured. (See page 66.)
- **Digital meters** and **analog meters** have internal resistance, which influences the value of the circuit variable being measured. Meters based on the d'Arsonval meter

movement deliberately include internal resistance as a way to limit the current in the movement's coil. (See page 67.)

- The **Wheatstone bridge** circuit is used to make precise measurements of a resistor's value using four resistors, a dc voltage source, and a galvanometer. A Wheatstone bridge is balanced when the resistors obey Eq. 3.33, resulting in a galvanometer reading of 0 A. (See page 69.)
- A circuit with three resistors connected in a  $\Delta$  configuration (or a  $\pi$  configuration) can be transformed into an equivalent circuit in which the three resistors are Y connected (or T connected). The  $\Delta$ -to-Y transformation is given by Eqs. 3.44–3.46; the Y-to- $\Delta$  transformation is given by Eqs. 3.47–3.49. (See page 72.)

## Problems

### Sections 3.1–3.2

- 3.1** a) Show that the solution of the circuit in Fig. 3.9 (see Example 3.1) satisfies Kirchhoff's current law at junctions  $x$  and  $y$ .  
PSPICE MULTISIM
- b) Show that the solution of the circuit in Fig. 3.9 satisfies Kirchhoff's voltage law around every closed loop.
- 3.2** a) Find the power dissipated in each resistor in the circuit shown in Fig. 3.9.  
PSPICE MULTISIM
- b) Find the power delivered by the 120 V source.
- c) Show that the power delivered equals the power dissipated.

- 3.3** For each of the circuits shown in Fig. P3.3, a) identify the resistors connected in series, b) simplify the circuit by replacing the series-connected resistors with equivalent resistors.
- 3.4** For each of the circuits shown in Fig. P3.4, a) identify the resistors connected in parallel, b) simplify the circuit by replacing the parallel-connected resistors with equivalent resistors.
- 3.5** For each of the circuits shown in Fig. P3.3, a) find the equivalent resistance seen by the source, b) find the power developed by the source.

Figure P3.3

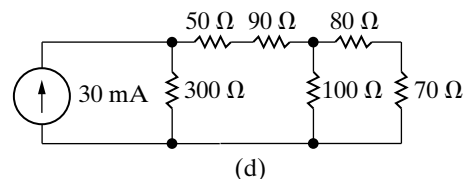
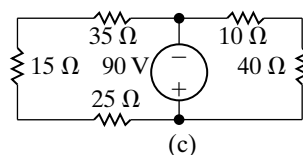
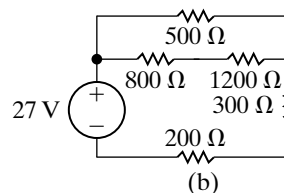
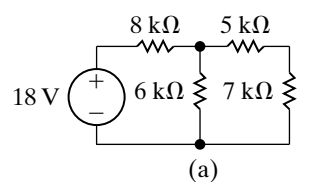
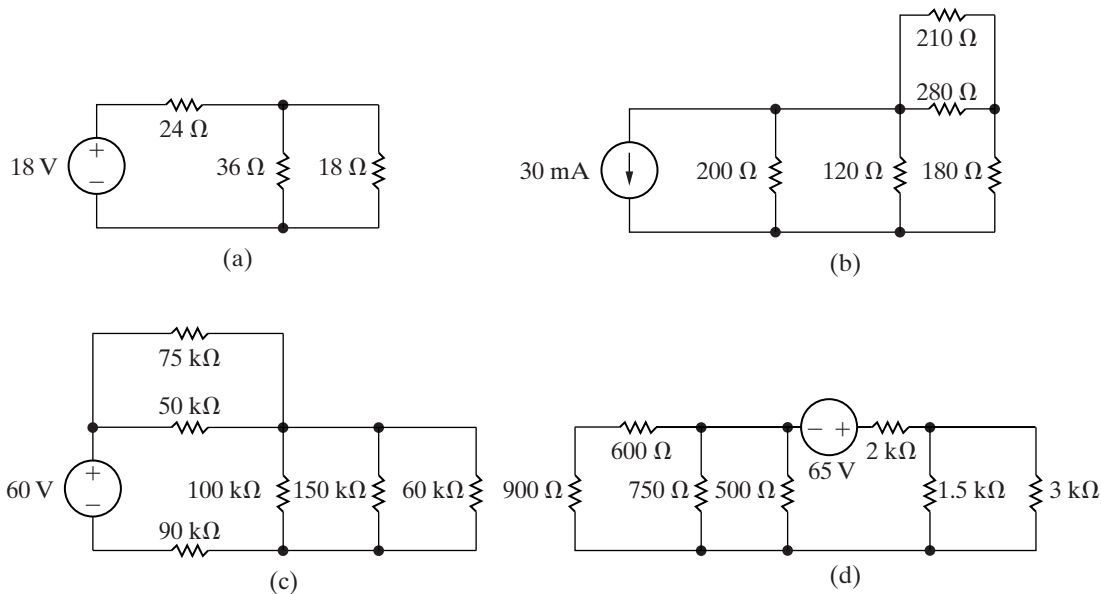


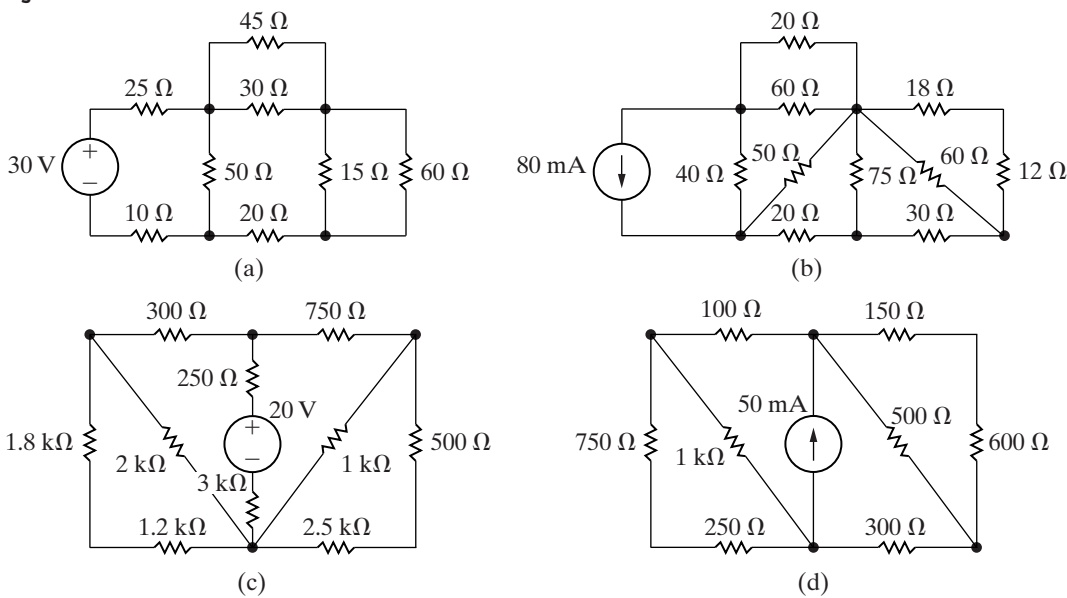
Figure P3.4



- 3.6** For each of the circuits shown in Fig. P3.4,  
 a) find the equivalent resistance seen by the source,  
 b) find the power developed by the source.

- 3.7** a) In the circuits in Fig. P3.7(a)–(d), find the equivalent resistance seen by the source.  
 b) For each circuit find the power delivered by the source.

Figure P3.7



- 3.8** Find the equivalent resistance  $R_{ab}$  for each of the circuits in Fig. P3.8.

- 3.9** Find the equivalent resistance  $R_{ab}$  for each of the circuits in Fig. P3.9.

Figure P3.8

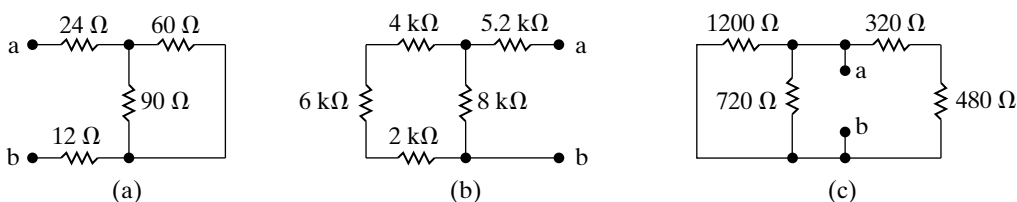
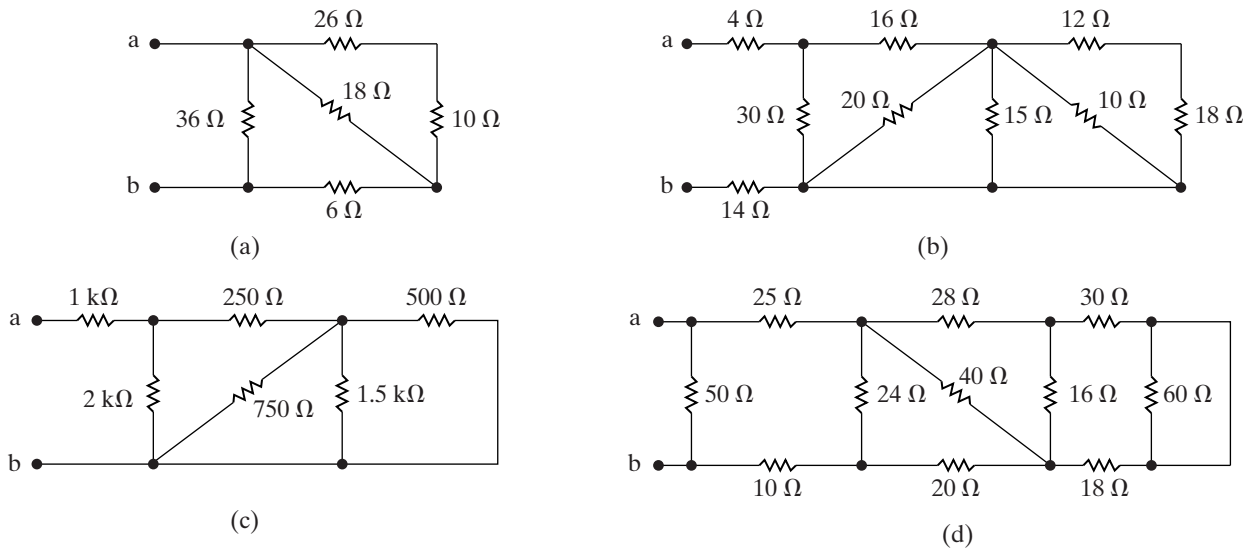


Figure P3.9



- 3.10** a) Find an expression for the equivalent resistance of two resistors of value  $R$  in series.  
 b) Find an expression for the equivalent resistance of  $n$  resistors of value  $R$  in series.  
 c) Using the results of (a), design a resistive network with an equivalent resistance of  $3 \text{ k}\Omega$  using two resistors with the same value from Appendix H.  
 d) Using the results of (b), design a resistive network with an equivalent resistance of  $4 \text{ k}\Omega$  using a minimum number of identical resistors from Appendix H.

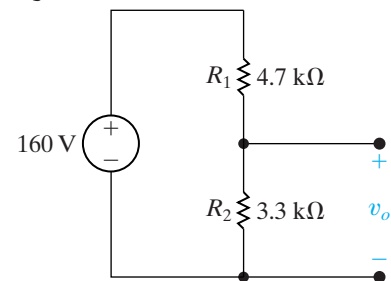
- 3.11** a) Find an expression for the equivalent resistance of two resistors of value  $R$  in parallel.  
 b) Find an expression for the equivalent resistance of  $n$  resistors of value  $R$  in parallel.  
 c) Using the results of (a), design a resistive network with an equivalent resistance of  $5 \text{ k}\Omega$  using two resistors with the same value from Appendix H.  
 d) Using the results of (b), design a resistive network with an equivalent resistance of  $4 \text{ k}\Omega$  using a minimum number of identical resistors from Appendix H.

### Section 3.3

- 3.12** a) Calculate the no-load voltage  $v_o$  for the voltage-divider circuit shown in Fig. P3.12.  
 b) Calculate the power dissipated in  $R_1$  and  $R_2$ .  
 c) Assume that only  $0.5 \text{ W}$  resistors are available. The no-load voltage is to be the same as in (a). Specify the smallest ohmic values of  $R_1$  and  $R_2$ .

DESIGN  
PROBLEM  
PSPICE  
MULTISIM

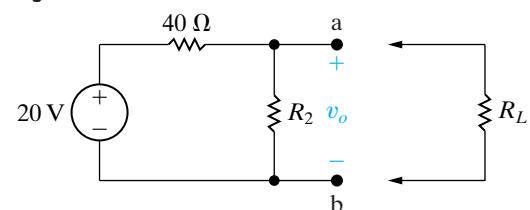
Figure P3.12



- 3.13** In the voltage-divider circuit shown in Fig. P3.13, the no-load value of  $v_o$  is  $4 \text{ V}$ . When the load resistance  $R_L$  is attached across the terminals a and b,  $v_o$  drops to  $3 \text{ V}$ . Find  $R_L$ .

PSPICE  
MULTISIM

Figure P3.13



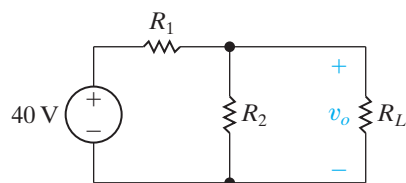
- 3.14** The no-load voltage in the voltage-divider circuit shown in Fig. P3.14 is  $8 \text{ V}$ . The smallest load resistor that is ever connected to the divider is  $3.6 \text{ k}\Omega$ . When the divider is loaded,  $v_o$  is not to drop below  $7.5 \text{ V}$ .

DESIGN  
PROBLEM  
PSPICE  
MULTISIM

- a) Design the divider circuit to meet the specifications just mentioned. Specify the numerical values of  $R_1$  and  $R_2$ .  
 b) Assume the power ratings of commercially available resistors are  $1/16$ ,  $1/8$ ,  $1/4$ ,  $1$ , and  $2 \text{ W}$ . What power rating would you specify?



Figure P3.14

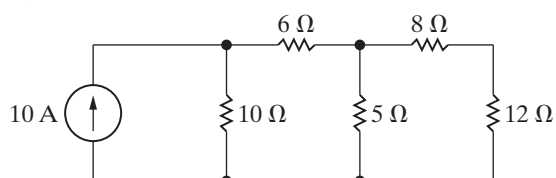


**3.15** Assume the voltage divider in Fig. P3.14 has been constructed from 1 W resistors. What is the smallest resistor from Appendix H that can be used as  $R_L$  before one of the resistors in the divider is operating at its dissipation limit?

**3.16** Find the power dissipated in the  $5\ \Omega$  resistor in the current divider circuit in Fig. P3.16.

PSPICE  
MULTISIM

Figure P3.16

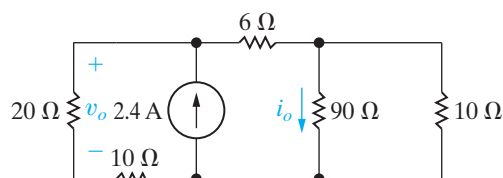


**3.17** For the current divider circuit in Fig. P3.17 calculate

PSPICE  
MULTISIM

- $i_o$  and  $v_o$ .
- the power dissipated in the  $6\ \Omega$  resistor.
- the power developed by the current source.

Figure P3.17



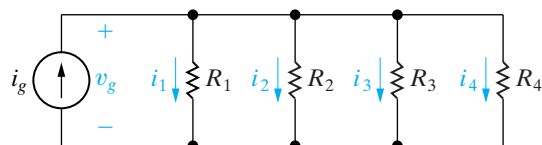
**3.18** Specify the resistors in the current divider circuit in Fig. P3.18 to meet the following design criteria:

DESIGN  
PROBLEM

$$i_g = 50\ \text{mA}; v_g = 25\ \text{V}; i_1 = 0.6i_2;$$

$$i_3 = 2i_2; \text{ and } i_4 = 4i_1.$$

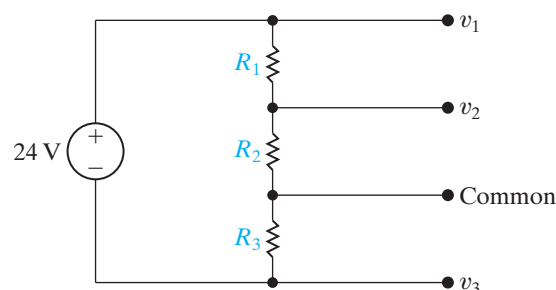
Figure P3.18



**3.19** There is often a need to produce more than one voltage using a voltage divider. For example, the memory components of many personal computers require voltages of  $-12\ \text{V}$ ,  $5\ \text{V}$ , and  $+12\ \text{V}$ , all with respect to a common reference terminal. Select the values of  $R_1$ ,  $R_2$ , and  $R_3$  in the circuit in Fig. P3.19 to meet the following design requirements:

- The total power supplied to the divider circuit by the  $24\ \text{V}$  source is  $80\ \text{W}$  when the divider is unloaded.
- The three voltages, all measured with respect to the common reference terminal, are  $v_1 = 12\ \text{V}$ ,  $v_2 = 5\ \text{V}$ , and  $v_3 = -12\ \text{V}$ .

Figure P3.19

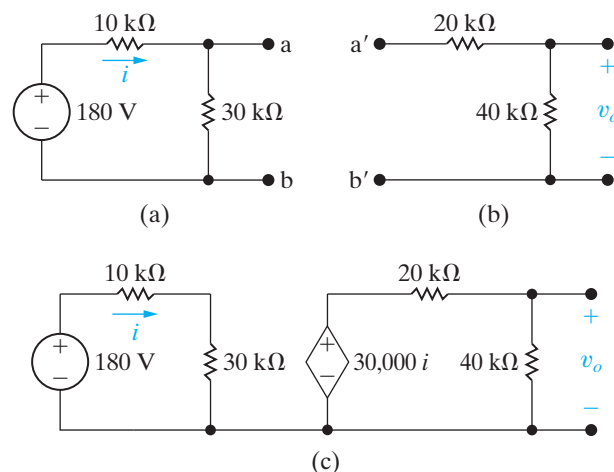


**3.20** a) The voltage divider in Fig. P3.20(a) is loaded with the voltage divider shown in Fig. P3.20(b); that is, a is connected to a', and b is connected to b'. Find  $v_o$ .

PSPICE  
MULTISIM

- Now assume the voltage divider in Fig. P3.20(b) is connected to the voltage divider in Fig. P3.20(a) by means of a current-controlled voltage source as shown in Fig. P3.20(c). Find  $v_o$ .
- What effect does adding the dependent-voltage source have on the operation of the voltage divider that is connected to the  $380\ \text{V}$  source?

Figure P3.20



**3.21** A voltage divider like that in Fig. 3.13 is to be designed so that  $v_o = kv_s$  at no load ( $R_L = \infty$ ) and  $v_o = \alpha v_s$  at full load ( $R_L = R_o$ ). Note that by definition  $\alpha < k < 1$ .

DESIGN  
PROBLEM

- Show that

$$R_1 = \frac{k - \alpha}{\alpha k} R_o$$

and

$$R_2 = \frac{k - \alpha}{\alpha(1 - k)} R_o.$$

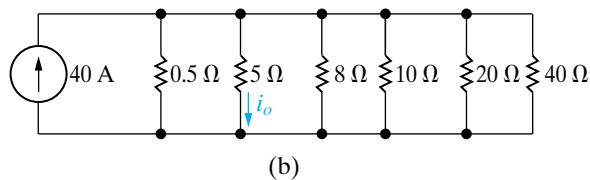
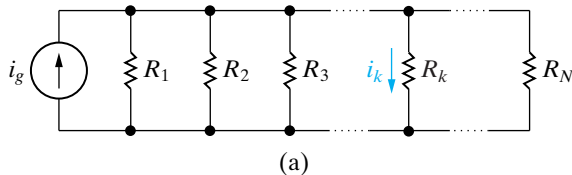
- Specify the numerical values of  $R_1$  and  $R_2$  if  $k = 0.85$ ,  $\alpha = 0.80$ , and  $R_o = 34 \text{ k}\Omega$ .
- If  $v_s = 60 \text{ V}$ , specify the maximum power that will be dissipated in  $R_1$  and  $R_2$ .
- Assume the load resistor is accidentally short circuited. How much power is dissipated in  $R_1$  and  $R_2$ ?

- 3.22** a) Show that the current in the  $k$ th branch of the circuit in Fig. P3.22(a) is equal to the source current  $i_g$  times the conductance of the  $k$ th branch divided by the sum of the conductances, that is,

$$i_k = \frac{i_g G_k}{G_1 + G_2 + G_3 + \cdots + G_k + \cdots + G_N}.$$

- Use the result derived in (a) to calculate the current in the  $5 \Omega$  resistor in the circuit in Fig. P3.22(b).

Figure P3.22



### Section 3.4

- 3.23** Look at the circuit in Fig. P3.3(a).

- Use voltage division to find the voltage across the  $6 \text{ k}\Omega$  resistor, positive at the top.
- Use the result from part (a) and voltage division to find the voltage across the  $5 \text{ k}\Omega$  resistor, positive on the left.

- 3.24** Look at the circuit in Fig. P3.3(d).

- Use current division to find the current in the  $50 \Omega$  resistor from left to right.
- Use the result from part (a) and current division to find the current in the  $70 \Omega$  resistor from top to bottom.

- 3.25** Look at the circuit in Fig. P3.7(a).

- Use voltage division to find the voltage drop across the  $25 \Omega$  resistor, positive at the left.
- Using your result from (a), find the current flowing in the  $25 \Omega$  resistor from left to right.
- Starting with your result from (b), use current division to find the current in the  $50 \Omega$  resistor from top to bottom.
- Using your result from part (c), find the voltage drop across the  $50 \Omega$  resistor, positive at the top.
- Starting with your result from (d), use voltage division to find the voltage drop across the  $60 \Omega$  resistor, positive at the top.

- 3.26** Attach a  $450 \text{ mA}$  current source between the terminals a–b in Fig. P3.9(a), with the current arrow pointing up.

- Use current division to find the current in the  $36 \Omega$  resistor from top to bottom.
- Use the result from part (a) to find the voltage across the  $36 \Omega$  resistor, positive at the top.
- Use the result from part (b) and voltage division to find the voltage across the  $18 \Omega$  resistor, positive at the top.
- Use the result from part (c) and voltage division to find the voltage across the  $10 \Omega$  resistor, positive at the top.

- 3.27** Attach a  $6 \text{ V}$  voltage source between the terminals a–b in Fig. P3.9(b), with the positive terminal at the top.

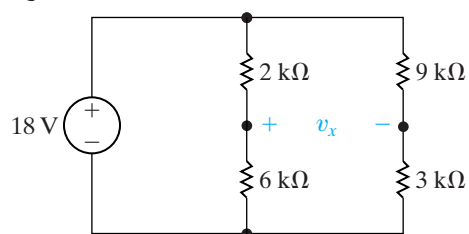
- Use voltage division to find the voltage across the  $4 \Omega$  resistor, positive at the top.
- Use the result from part (a) to find the current in the  $4 \Omega$  resistor from left to right.
- Use the result from part (b) and current division to find the current in the  $16 \Omega$  resistor from left to right.
- Use the result from part (c) and current division to find the current in the  $10 \Omega$  resistor from top to bottom.
- Use the result from part (d) to find the voltage across the  $10 \Omega$  resistor, positive at the top.
- Use the result from part (e) and voltage division to find the voltage across the  $18 \Omega$  resistor, positive at the top.

- 3.28** a) Find the voltage  $v_x$  in the circuit in Fig. P3.28 using voltage and/or current division.

PSPICE  
MULTISIM

- b) Replace the 18 V source with a general voltage source equal to  $V_s$ . Assume  $V_s$  is positive at the upper terminal. Find  $v_x$  as a function of  $V_s$ .

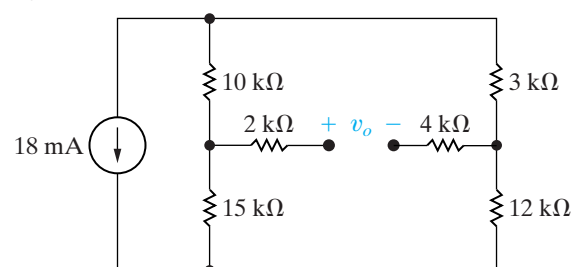
Figure P3.28



- 3.29** Find  $v_o$  in the circuit in Fig. P3.29 using voltage and/or current division.

PSPICE  
MULTISIM

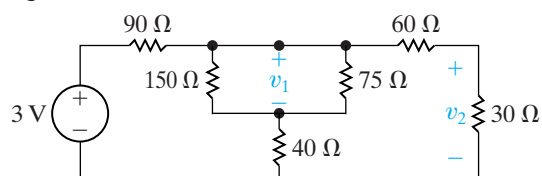
Figure P3.29



- 3.30** Find  $v_1$  and  $v_2$  in the circuit in Fig. P3.30 using voltage and/or current division.

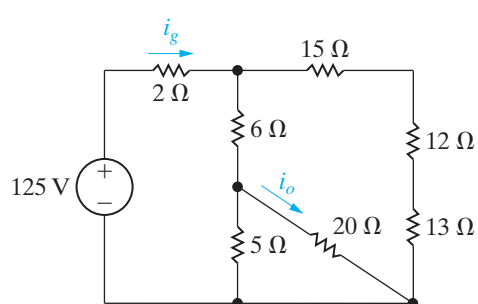
PSPICE  
MULTISIM

Figure P3.30



- 3.31** For the circuit in Fig. P3.31, find  $i_g$  and then use current division to find  $i_o$ .

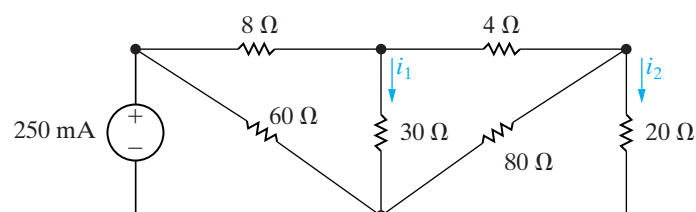
Figure P3.31



- 3.32** For the circuit in Fig. P3.32, calculate  $i_1$  and  $i_2$  using current division.

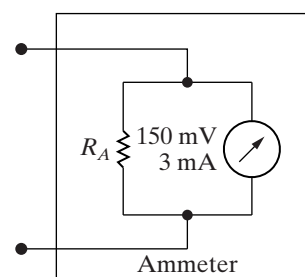
PSPICE  
MULTISIM

Figure P3.32



- 3.33** A d'Arsonval ammeter is shown in Fig. P3.33.
- Calculate the value of the shunt resistor,  $R_A$ , to give a full-scale current reading of 5 A.
  - How much resistance is added to a circuit when the 5 A ammeter in part (a) is inserted to measure current?
  - Calculate the value of the shunt resistor,  $R_A$ , to give a full-scale current reading of 100 mA.
  - How much resistance is added to a circuit when the 100 mA ammeter in part (c) is inserted to measure current?

Figure P3.33

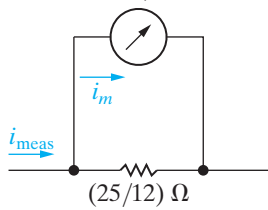


- 3.34** A shunt resistor and a 50 mV, 1 mA d'Arsonval movement are used to build a 5 A ammeter. A resistance of 20 mΩ is placed across the terminals of the ammeter. What is the new full-scale range of the ammeter?

- 3.35** A d'Arsonval movement is rated at 2 mA and 200 mV. Assume 1 W precision resistors are available to use as shunts. What is the largest full-scale-reading ammeter that can be designed using a single resistor? Explain.

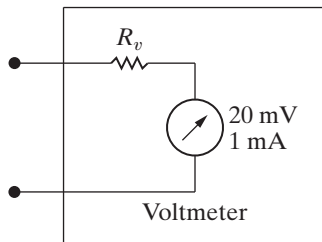
- 3.36**
- Show for the ammeter circuit in Fig. P3.36 that the current in the d'Arsonval movement is always 1/25th of the current being measured.
  - What would the fraction be if the 100 mV, 2 mA movement were used in a 5 A ammeter?
  - Would you expect a uniform scale on a dc d'Arsonval ammeter?

**Figure P3.36**  
100 mV, 2 mA



**3.37** A d'Arsonval voltmeter is shown in Fig. P3.37. Find the value of  $R_v$  for each of the following full-scale readings: (a) 50 V, (b) 5 V, (c) 250 mV, and (d) 25 mV.

**Figure P3.37**

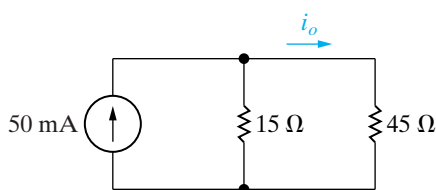


**3.38** Suppose the d'Arsonval voltmeter described in Problem 3.37 is used to measure the voltage across the 45  $\Omega$  resistor in Fig. P3.38.

- a) What will the voltmeter read?
- b) Find the percentage of error in the voltmeter reading if

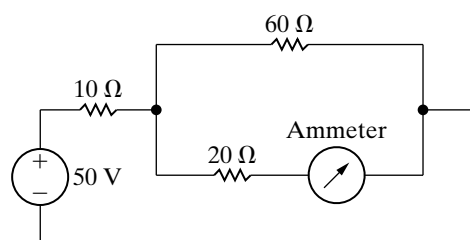
$$\% \text{ error} = \left( \frac{\text{measured value}}{\text{true value}} - 1 \right) \times 100.$$

**Figure P3.38**



**3.39** The ammeter in the circuit in Fig. P3.39 has a resistance of 0.1  $\Omega$ . Using the definition of the percentage error in a meter reading found in Problem 3.38, what is the percentage of error in the reading of this ammeter?

**Figure P3.39**



**3.40** The ammeter described in Problem 3.39 is used to measure the current  $i_o$  in the circuit in Fig. P3.38. What is the percentage of error in the measured value?

**3.41** The elements in the circuit in Fig. 2.24 have the following values:  $R_1 = 20 \text{ k}\Omega$ ,  $R_2 = 80 \text{ k}\Omega$ ,  $R_C = 0.82 \text{ k}\Omega$ ,  $R_E = 0.2 \text{ k}\Omega$ ,  $V_{CC} = 7.5 \text{ V}$ ,  $V_0 = 0.6 \text{ V}$ , and  $\beta = 39$ .

- a) Calculate the value of  $i_B$  in microamperes.
- b) Assume that a digital multimeter, when used as a dc ammeter, has a resistance of 1 k $\Omega$ . If the meter is inserted between terminals b and 2 to measure the current  $i_B$ , what will the meter read?
- c) Using the calculated value of  $i_B$  in (a) as the correct value, what is the percentage of error in the measurement?

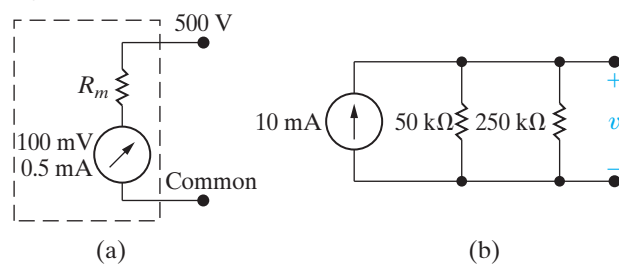
**3.42** You have been told that the dc voltage of a power supply is about 350 V. When you go to the instrument room to get a dc voltmeter to measure the power supply voltage, you find that there are only two dc voltmeters available. One voltmeter is rated 300 V full scale and has a sensitivity of 900  $\Omega/\text{V}$ . The other voltmeter is rated 150 V full scale and has a sensitivity of 1200  $\Omega/\text{V}$ . (*Hint*: you can find the effective resistance of a voltmeter by multiplying its rated full-scale voltage and its sensitivity.)

- a) How can you use the two voltmeters to check the power supply voltage?
- b) What is the maximum voltage that can be measured?
- c) If the power supply voltage is 320 V, what will each voltmeter read?

**3.43** Assume that in addition to the two voltmeters described in Problem 3.42, a 50 k $\Omega$  precision resistor is also available. The 50 k $\Omega$  resistor is connected in series with the series-connected voltmeters. This circuit is then connected across the terminals of the power supply. The reading on the 300 V meter is 205.2 V and the reading on the 150 V meter is 136.8 V. What is the voltage of the power supply?

**3.44** The voltmeter shown in Fig. P3.44(a) has a full-scale reading of 500 V. The meter movement is rated 100 mV and 0.5 mA. What is the percentage of error in the meter reading if it is used to measure the voltage  $v$  in the circuit of Fig. P3.44(b)?

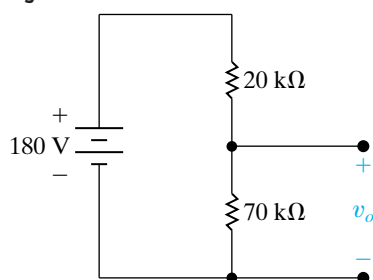
**Figure P3.44**



**3.45** The voltage-divider circuit shown in Fig. P3.45 is designed so that the no-load output voltage is  $7/9$ ths of the input voltage. A d'Arsonval voltmeter having a sensitivity of  $100 \Omega/\text{V}$  and a full-scale rating of  $200 \text{ V}$  is used to check the operation of the circuit.

- What will the voltmeter read if it is placed across the  $180 \text{ V}$  source?
- What will the voltmeter read if it is placed across the  $70 \text{ k}\Omega$  resistor?
- What will the voltmeter read if it is placed across the  $20 \text{ k}\Omega$  resistor?
- Will the voltmeter readings obtained in parts (b) and (c) add to the reading recorded in part (a)? Explain why or why not.

Figure P3.45

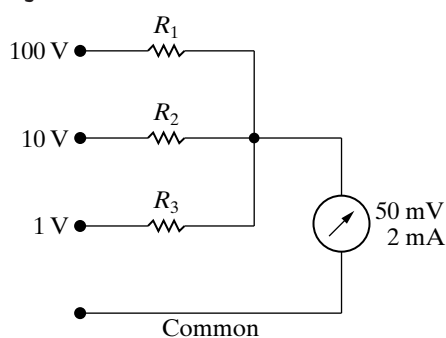


**3.46** Assume in designing the multirange voltmeter shown in Fig. P3.46 that you ignore the resistance of the meter movement.

DESIGN PROBLEM

- Specify the values of  $R_1$ ,  $R_2$ , and  $R_3$ .
- For each of the three ranges, calculate the percentage of error that this design strategy produces.

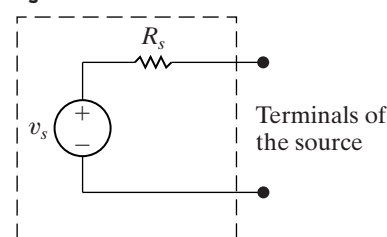
Figure P3.46



**3.47** The circuit model of a dc voltage source is shown in Fig. P3.47. The following voltage measurements are made at the terminals of the source: (1) With the terminals of the source open, the voltage is measured at  $50 \text{ mV}$ , and (2) with a  $15 \text{ M}\Omega$  resistor connected to the terminals, the voltage is measured at  $48.75 \text{ mV}$ . All measurements are made with a digital voltmeter that has a meter resistance of  $10 \text{ M}\Omega$ .

- What is the internal voltage of the source ( $v_s$ ) in millivolts?
- What is the internal resistance of the source ( $R_s$ ) in kilo-ohms?

Figure P3.47

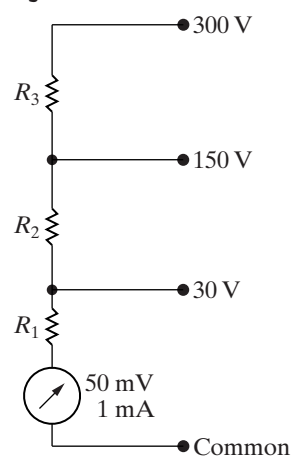


**3.48** Design a d'Arsonval voltmeter that will have the three voltage ranges shown in Fig. P3.48.

DESIGN PROBLEM

- Specify the values of  $R_1$ ,  $R_2$ , and  $R_3$ .
- Assume that a  $750 \text{ k}\Omega$  resistor is connected between the  $150 \text{ V}$  terminal and the common terminal. The voltmeter is then connected to an unknown voltage using the common terminal and the  $300 \text{ V}$  terminal. The voltmeter reads  $288 \text{ V}$ . What is the unknown voltage?
- What is the maximum voltage the voltmeter in (b) can measure?

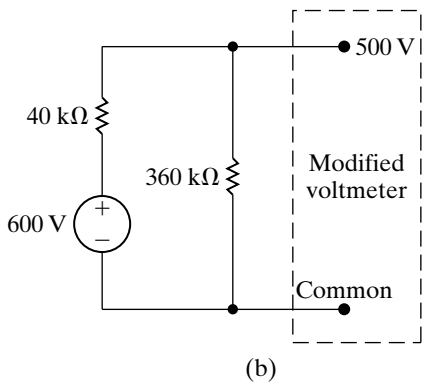
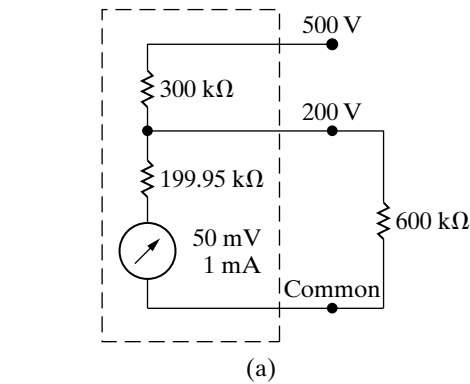
Figure P3.48



**3.49** A  $600 \text{ k}\Omega$  resistor is connected from the  $200 \text{ V}$  terminal to the common terminal of a dual-scale voltmeter, as shown in Fig. P3.49(a). This modified voltmeter is then used to measure the voltage across the  $360 \text{ k}\Omega$  resistor in the circuit in Fig. P3.49(b).

- What is the reading on the  $500 \text{ V}$  scale of the meter?
- What is the percentage of error in the measured voltage?

Figure P3.49



Section 3.6

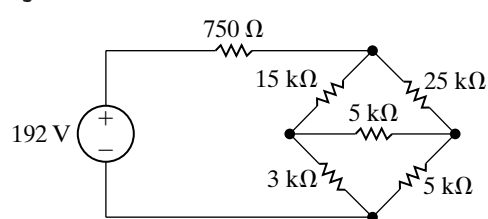
**3.50** Assume the ideal voltage source in Fig. 3.26 is replaced by an ideal current source. Show that Eq. 3.33 is still valid.

**3.51** The bridge circuit shown in Fig. 3.26 is energized from a 24 V dc source. The bridge is balanced when  $R_1 = 500 \Omega$ ,  $R_2 = 1000 \Omega$ , and  $R_3 = 750 \Omega$ .

- What is the value of  $R_x$ ?
- How much current (in milliamperes) does the dc source supply?
- Which resistor in the circuit absorbs the most power? How much power does it absorb?
- Which resistor absorbs the least power? How much power does it absorb?

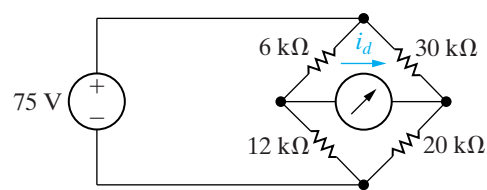
**3.52** Find the power dissipated in the 3 kΩ resistor in the circuit in Fig. P3.52.

Figure P3.52



**3.53** Find the detector current  $i_d$  in the unbalanced bridge in Fig. P3.53 if the voltage drop across the detector is negligible.

Figure P3.53



**3.54** In the Wheatstone bridge circuit shown in Fig. 3.26, the ratio  $R_2/R_1$  can be set to the following values: 0.001, 0.01, 0.1, 1, 10, 100, and 1000. The resistor  $R_3$  can be varied from 1 to 11,110 Ω, in increments of 1 Ω. An unknown resistor is known to lie between 4 and 5 Ω. What should be the setting of the  $R_2/R_1$  ratio so that the unknown resistor can be measured to four significant figures?

Section 3.7

**3.55** Find the current and power supplied by the 40 V source in the circuit for Example 3.7 (Fig. 3.32) by replacing the lower Δ (25, 37.5, and 40 Ω) with its equivalent Y.

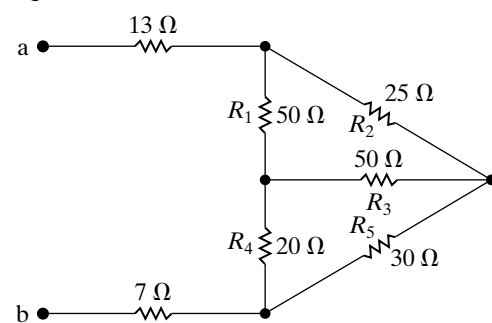
**3.56** Find the current and power supplied by the 40 V source in the circuit for Example 3.7 (Fig. 3.32) by replacing the Y on the left (25, 40, and 100 Ω) with its equivalent Δ.

**3.57** Find the current and power supplied by the 40 V source in the circuit for Example 3.7 (Fig. 3.32) by replacing the Y on the right (25, 37.5, and 125 Ω) with its equivalent Δ.

**3.58** a) Find the equivalent resistance  $R_{ab}$  in the circuit in Fig. P3.58 by using a Y-to-Δ transformation involving resistors  $R_2$ ,  $R_3$ , and  $R_5$ .

- Repeat (a) using a Δ-to-Y transformation involving resistors  $R_3$ ,  $R_4$ , and  $R_5$ .
- Give two additional Δ-to-Y or Y-to-Δ transformations that could be used to find  $R_{ab}$ .

Figure P3.58

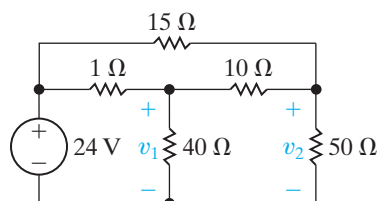




- 3.59** Use a  $\Delta$ -to- $Y$  transformation to find the voltages  $v_1$  and  $v_2$  in the circuit in Fig. P3.59.

PSPICE  
MULTISIM

Figure P3.59

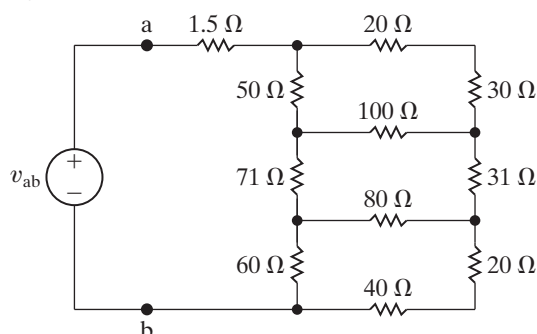


- 3.60** a) Find the resistance seen by the ideal voltage source in the circuit in Fig. P3.60.

PSPICE  
MULTISIM

- b) If  $v_{ab}$  equals 400 V, how much power is dissipated in the 31  $\Omega$  resistor?

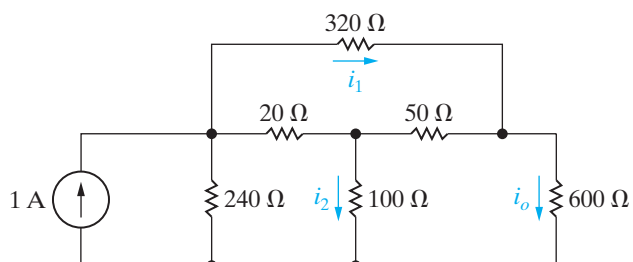
Figure P3.60



- 3.61** Use a  $Y$ -to- $\Delta$  transformation to find (a)  $i_o$ ; (b)  $i_1$ ; (c)  $i_2$ ; and (d) the power delivered by the ideal current source in the circuit in Fig. P3.61.

PSPICE  
MULTISIM

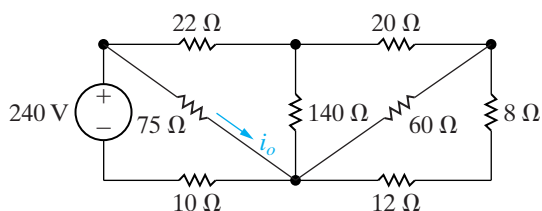
Figure P3.61



- 3.62** Find  $i_o$  and the power dissipated in the 140  $\Omega$  resistor in the circuit in Fig. P3.62.

PSPICE  
MULTISIM

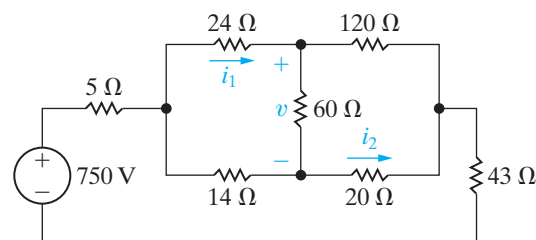
Figure P3.62



- 3.63** For the circuit shown in Fig. P3.63, find (a)  $i_1$ , (b)  $v$ , (c)  $i_2$ , and (d) the power supplied by the voltage source.

PSPICE  
MULTISIM

Figure P3.63



- 3.64** Show that the expressions for  $\Delta$  conductances as functions of the three  $Y$  conductances are

$$G_a = \frac{G_2 G_3}{G_1 + G_2 + G_3},$$

$$G_b = \frac{G_1 G_3}{G_1 + G_2 + G_3},$$

$$G_c = \frac{G_1 G_2}{G_1 + G_2 + G_3},$$

where

$$G_a = \frac{1}{R_a}, \quad G_1 = \frac{1}{R_1}, \quad \text{etc.}$$

- 3.65** Derive Eqs. 3.44–3.49 from Eqs. 3.41–3.43. The following two hints should help you get started in the right direction:

- To find  $R_1$  as a function of  $R_a$ ,  $R_b$ , and  $R_c$ , first subtract Eq. 3.42 from Eq. 3.43 and then add this result to Eq. 3.41. Use similar manipulations to find  $R_2$  and  $R_3$  as functions of  $R_a$ ,  $R_b$ , and  $R_c$ .
- To find  $R_b$  as a function of  $R_1$ ,  $R_2$ , and  $R_3$ , take advantage of the derivations obtained by hint (1), namely, Eqs. 3.44–3.46. Note that these equations can be divided to obtain

$$\frac{R_2}{R_3} = \frac{R_c}{R_b}, \quad \text{or} \quad R_c = \frac{R_2}{R_3} R_b,$$

and

$$\frac{R_1}{R_2} = \frac{R_b}{R_a}, \quad \text{or} \quad R_a = \frac{R_2}{R_1} R_b.$$

Now use these ratios in Eq. 3.43 to eliminate  $R_a$  and  $R_c$ . Use similar manipulations to find  $R_a$  and  $R_c$  as functions of  $R_1$ ,  $R_2$ , and  $R_3$ .

### Sections 3.1–3.7

- 3.66** Resistor networks are sometimes used as volume-control circuits. In this application, they are referred to as *resistance attenuators* or *pads*.

DESIGN  
PROBLEM



A typical fixed-attenuator pad is shown in Fig. P3.66. In designing an attenuation pad, the circuit designer will select the values of  $R_1$  and  $R_2$  so that the ratio of  $v_o/v_i$  and the resistance seen by the input voltage source  $R_{ab}$  both have a specified value.

a) Show that if  $R_{ab} = R_L$ , then

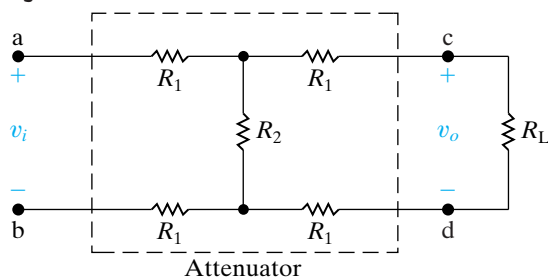
$$R_L^2 = 4R_1(R_1 + R_2),$$

$$\frac{v_o}{v_i} = \frac{R_2}{2R_1 + R_2 + R_L}.$$

b) Select the values of  $R_1$  and  $R_2$  so that  $R_{ab} = R_L = 300 \Omega$  and  $v_o/v_i = 0.5$ .

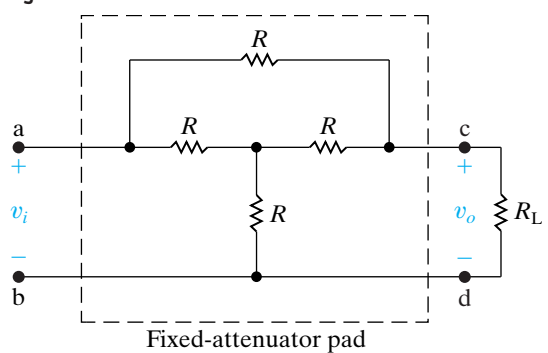
c) Choose values from Appendix H that are closest to  $R_1$  and  $R_2$  from part (b). Calculate the percent error in the resulting values for  $R_{ab}$  and  $v_o/v_i$  if these new resistor values are used.

Figure P3.66



- 3.67** a) The fixed-attenuator pad shown in Fig. P3.67 is called a *bridged tee*. Use a Y-to- $\Delta$  transformation to show that  $R_{ab} = R_L$  if  $R = R_L$ .  
 b) Show that when  $R = R_L$ , the voltage ratio  $v_o/v_i$  equals 0.50.

Figure P3.67



**3.68** The design equations for the bridged-tee attenuator circuit in Fig. P3.68 are

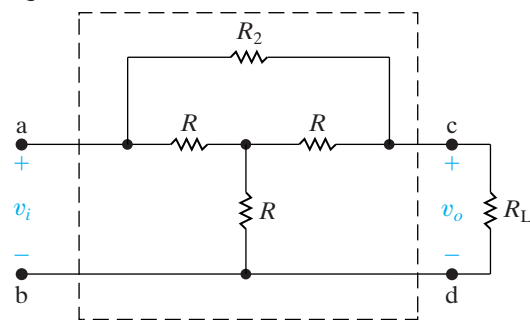
$$R_2 = \frac{2RR_L^2}{3R^2 - R_L^2},$$

$$\frac{v_o}{v_i} = \frac{3R - R_L}{3R + R_L},$$

when  $R_2$  has the value just given.

- a) Design a fixed attenuator so that  $v_i = 3.5v_o$  when  $R_L = 300 \Omega$ .  
 b) Assume the voltage applied to the input of the pad designed in (a) is 42 V. Which resistor in the pad dissipates the most power?  
 c) How much power is dissipated in the resistor in part (b)?  
 d) Which resistor in the pad dissipates the least power?  
 e) How much power is dissipated in the resistor in part (d)?

Figure P3.68

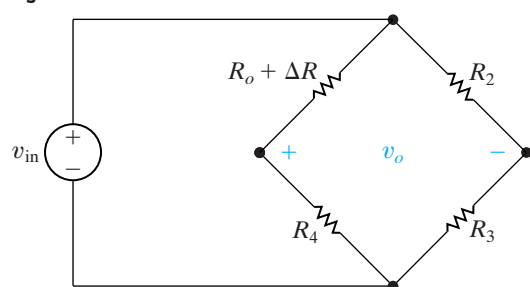


**3.69** a) For the circuit shown in Fig. P3.69 the bridge is balanced when  $\Delta R = 0$ . Show that if  $\Delta R \ll R_o$  the bridge output voltage is approximately

$$v_o \approx \frac{-\Delta R R_4}{(R_o + R_4)^2} v_{in}$$

- b) Given  $R_2 = 1 \text{ k}\Omega$ ,  $R_3 = 500 \Omega$ ,  $R_4 = 5 \text{ k}\Omega$ , and  $v_{in} = 6 \text{ V}$ , what is the approximate bridge output voltage if  $\Delta R$  is 3% of  $R_o$ ?  
 c) Find the actual value of  $v_o$  in part (b).

Figure P3.69



**3.70** a) If percent error is defined as

$$\% \text{ error} = \left[ \frac{\text{approximate value}}{\text{true value}} - 1 \right] \times 100,$$

show that the percent error in the approximation of  $v_o$  in Problem 3.69 is

$$\% \text{ error} = \frac{-(\Delta R)R_3}{(R_2 + R_3)R_4} \times 100.$$

b) Calculate the percent error in  $v_o$ , using the values in Problem 3.69(b).

**3.71** Assume the error in  $v_o$  in the bridge circuit in Fig. P3.69 is not to exceed 0.5%. What is the largest percent change in  $R_o$  that can be tolerated?

DESIGN  
PROBLEM

**3.72** a) Using Fig. 3.38 derive the expression for the voltage  $V_y$ .

b) Assuming that there are  $p_y$  pixels in the  $y$ -direction, derive the expression for the  $y$ -coordinate of the touch point, using the result from part (a).

**3.73** A resistive touch screen has 5 V applied to the grid in the  $x$ -direction and in the  $y$ -direction. The screen has 480 pixels in the  $x$ -direction and 800 pixels in

PRACTICAL  
PERSPECTIVE  
PSPICE  
MULTISIM

the  $y$ -direction. When the screen is touched, the voltage in the  $x$ -grid is 1 V and the voltage in the  $y$ -grid is 3.75 V.)

a) Calculate the values of  $\alpha$  and  $\beta$ .

a) Calculate the  $x$ - and  $y$ -coordinates of the pixel at the point where the screen was touched.

**3.74** A resistive touch screen has 640 pixels in the  $x$ -direction and 1024 pixels in the  $y$ -direction. The resistive grid has 8 V applied in both the  $x$ - and  $y$ -directions. The pixel coordinates at the touch point are (480, 192). Calculate the voltages  $V_x$  and  $V_y$ .

PRACTICAL  
PERSPECTIVE  
DESIGN  
PROBLEM  
PSPICE  
MULTISIM

**3.75** Suppose the resistive touch screen described in Problem 3.74 is simultaneously touched at two points, one with coordinates (480, 192) and the other with coordinates (240, 384).

a) Calculate the voltage measured in the  $x$ - and  $y$ -grids.

b) Which touch point has your calculation in (a) identified?

# Techniques of Circuit Analysis

## CHAPTER CONTENTS

- 4.1 Terminology *p. 90*
- 4.2 Introduction to the Node-Voltage Method *p. 93*
- 4.3 The Node-Voltage Method and Dependent Sources *p. 95*
- 4.4 The Node-Voltage Method: Some Special Cases *p. 96*
- 4.5 Introduction to the Mesh-Current Method *p. 99*
- 4.6 The Mesh-Current Method and Dependent Sources *p. 102*
- 4.7 The Mesh-Current Method: Some Special Cases *p. 103*
- 4.8 The Node-Voltage Method Versus the Mesh-Current Method *p. 106*
- 4.9 Source Transformations *p. 109*
- 4.10 Thévenin and Norton Equivalent Circuits *p. 113*
- 4.11 More on Deriving a Thévenin Equivalent *p. 117*
- 4.12 Maximum Power Transfer *p. 120*
- 4.13 Superposition *p. 122*

## ✓ CHAPTER OBJECTIVES

- 1 Understand and be able to use the node-voltage method to solve a circuit.
- 2 Understand and be able to use the mesh-current method to solve a circuit.
- 3 Be able to decide whether the node-voltage method or the mesh-current method is the preferred approach to solving a particular circuit.
- 4 Understand source transformation and be able to use it to solve a circuit.
- 5 Understand the concept of the Thévenin and Norton equivalent circuits and be able to construct a Thévenin or Norton equivalent for a circuit.
- 6 Know the condition for maximum power transfer to a resistive load and be able to calculate the value of the load resistor that satisfies this condition.

So far, we have analyzed relatively simple resistive circuits by applying Kirchhoff's laws in combination with Ohm's law. We can use this approach for all circuits, but as they become structurally more complicated and involve more and more elements, this direct method soon becomes cumbersome. In this chapter we introduce two powerful techniques of circuit analysis that aid in the analysis of complex circuit structures: the node-voltage method and the mesh-current method. These techniques give us two systematic methods of describing circuits with the minimum number of simultaneous equations.

In addition to these two general analytical methods, in this chapter we also discuss other techniques for simplifying circuits. We have already demonstrated how to use series-parallel reductions and  $\Delta$ -to- $Y$  transformations to simplify a circuit's structure. We now add source transformations and Thévenin and Norton equivalent circuits to those techniques.

We also consider two other topics that play a role in circuit analysis. One, maximum power transfer, considers the conditions necessary to ensure that the power delivered to a resistive load by a source is maximized. Thévenin equivalent circuits are used in establishing the maximum power transfer conditions. The final topic in this chapter, superposition, looks at the analysis of circuits with more than one independent source.

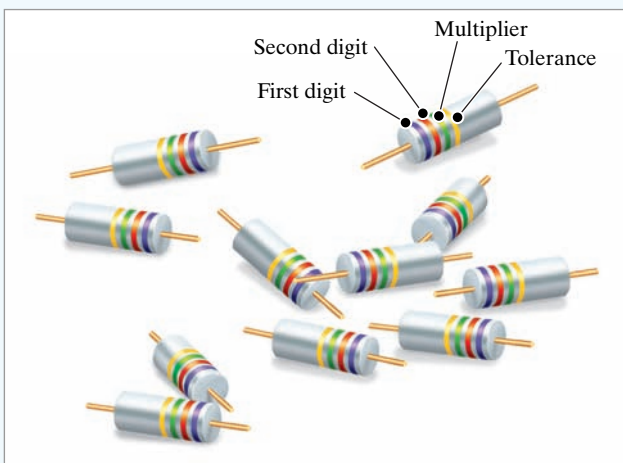
## Practical Perspective

### Circuits with Realistic Resistors

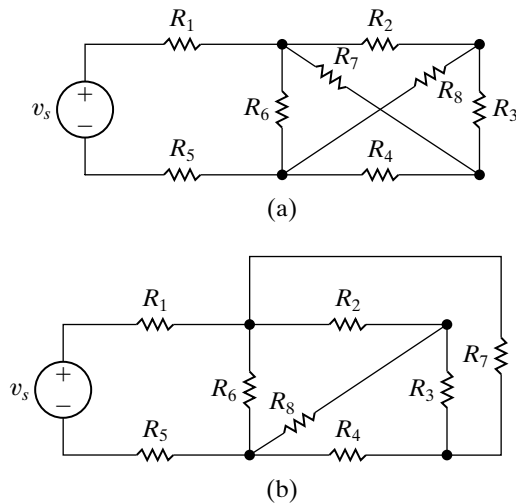
In the last chapter we began to explore the effect of imprecise resistor values on the performance of a circuit; specifically, on the performance of a voltage divider. Resistors are manufactured for only a small number of discrete values, and any given resistor from a batch of resistors will vary from its stated value within some tolerance. Resistors with tighter tolerance, say 1%, are more expensive than resistors with greater tolerance, say 10%. Therefore, in a circuit that uses many resistors, it would be important to understand which resistor's value has the greatest impact on the expected performance of the circuit.

In other words, we would like to predict the effect of varying each resistor's value on the output of the circuit. If we know that a particular resistor must be very close to its stated value for the circuit to function correctly, we can then decide to spend the extra money necessary to achieve a tighter tolerance on that resistor's value.

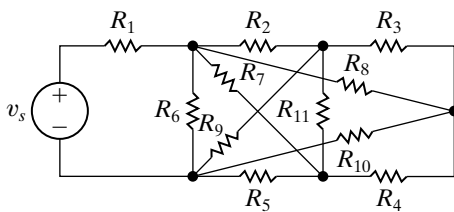
Exploring the effect of a circuit component's value on the circuit's output is known as **sensitivity analysis**. Once we have presented additional circuit analysis techniques, the topic of sensitivity analysis will be examined.



Ocean/Corbis



**Figure 4.1** ▲ (a) A planar circuit. (b) The same circuit redrawn to verify that it is planar.



**Figure 4.2** ▲ A nonplanar circuit.

## 4.1 Terminology

To discuss the more involved methods of circuit analysis, we must define a few basic terms. So far, all the circuits presented have been **planar circuits**—that is, those circuits that can be drawn on a plane with no crossing branches. A circuit that is drawn with crossing branches still is considered planar if it can be redrawn with no crossover branches. For example, the circuit shown in Fig. 4.1(a) can be redrawn as Fig. 4.1(b); the circuits are equivalent because all the node connections have been maintained. Therefore, Fig. 4.1(a) is a planar circuit because it can be redrawn as one. Figure 4.2 shows a nonplanar circuit—it cannot be redrawn in such a way that all the node connections are maintained and no branches overlap. The node-voltage method is applicable to both planar and nonplanar circuits, whereas the mesh-current method is limited to planar circuits.

### Describing a Circuit—The Vocabulary

In Section 1.5 we defined an ideal basic circuit element. When basic circuit elements are interconnected to form a circuit, the resulting interconnection is described in terms of nodes, paths, branches, loops, and meshes. We defined both a node and a closed path, or loop, in Section 2.4. Here we restate those definitions and then define the terms *path*, *branch*, and *mesh*. For your convenience, all of these definitions are presented in Table 4.1. Table 4.1 also includes examples of each definition taken from the circuit in Fig. 4.3, which are developed in Example 4.1.

#### Example 4.1 Identifying Node, Branch, Mesh and Loop in a Circuit

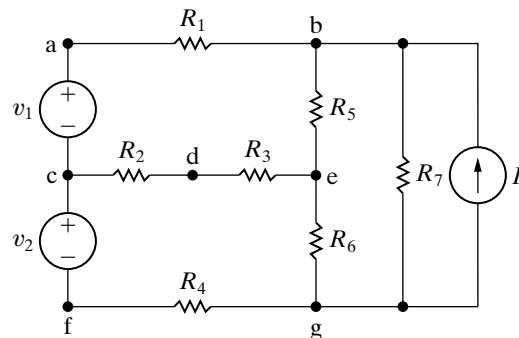
For the circuit in Fig. 4.3, identify

- all nodes.
- all essential nodes.
- all branches.
- all essential branches.
- all meshes.
- two paths that are not loops or essential branches.
- two loops that are not meshes.

#### Solution

- The nodes are a, b, c, d, e, f, and g.
- The essential nodes are b, c, e, and g.
- The branches are  $v_1$ ,  $v_2$ ,  $R_1$ ,  $R_2$ ,  $R_3$ ,  $R_4$ ,  $R_5$ ,  $R_6$ ,  $R_7$ , and  $I$ .
- The essential branches are  $v_1 - R_1$ ,  $R_2 - R_3$ ,  $v_2 - R_4$ ,  $R_5$ ,  $R_6$ ,  $R_7$ , and  $I$ .
- The meshes are  $v_1 - R_1 - R_5 - R_3 - R_2$ ,  $v_2 - R_2 - R_3 - R_6 - R_4$ ,  $R_5 - R_7 - R_6$ , and  $R_7 - I$ .

**NOTE:** Assess your understanding of this material by trying Chapter Problems 4.1 and 4.5.



**Figure 4.3** ▲ A circuit illustrating nodes, branches, meshes, paths, and loops.

- $R_1 - R_5 - R_6$  is a path, but it is not a loop (because it does not have the same starting and ending nodes), nor is it an essential branch (because it does not connect two essential nodes).  $v_2 - R_2$  is also a path but is neither a loop nor an essential branch, for the same reasons.
- $v_1 - R_1 - R_5 - R_6 - R_4 - v_2$  is a loop but is not a mesh, because there are two loops within it.  $I - R_5 - R_6$  is also a loop but not a mesh.

TABLE 4.1 Terms for Describing Circuits

Name	Definition	Example From Fig. 4.3
node	A point where two or more circuit elements join	a
essential node	A node where three or more circuit elements join	b
path	A trace of adjoining basic elements with no elements included more than once	$v_1 - R_1 - R_5 - R_6$
branch	A path that connects two nodes	$R_1$
essential branch	A path which connects two essential nodes without passing through an essential node	$v_1 - R_1$
loop	A path whose last node is the same as the starting node	$v_1 - R_1 - R_5 - R_6 - R_4 - v_2$
mesh	A loop that does not enclose any other loops	$v_1 - R_1 - R_5 - R_3 - R_2$
planar circuit	A circuit that can be drawn on a plane with no crossing branches	Fig. 4.3 is a planar circuit Fig. 4.2 is a nonplanar circuit

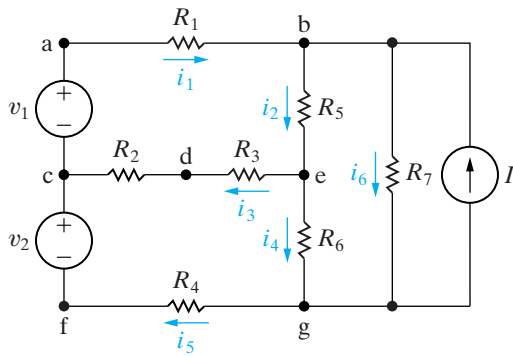
## Simultaneous Equations—How Many?

The number of unknown currents in a circuit equals the number of branches,  $b$ , where the current is not known. For example, the circuit shown in Fig. 4.3 has nine branches in which the current is unknown. Recall that we must have  $b$  independent equations to solve a circuit with  $b$  unknown currents. If we let  $n$  represent the number of nodes in the circuit, we can derive  $n - 1$  independent equations by applying Kirchhoff's current law to any set of  $n - 1$  nodes. (Application of the current law to the  $n$ th node does not generate an independent equation, because this equation can be derived from the previous  $n - 1$  equations. See Problem 4.5.) Because we need  $b$  equations to describe a given circuit and because we can obtain  $n - 1$  of these equations from Kirchhoff's current law, we must apply Kirchhoff's voltage law to loops or meshes to obtain the remaining  $b - (n - 1)$  equations.

Thus by counting nodes, meshes, and branches where the current is unknown, we have established a systematic method for writing the necessary number of equations to solve a circuit. Specifically, we apply Kirchhoff's current law to  $n - 1$  nodes and Kirchhoff's voltage law to  $b - (n - 1)$  loops (or meshes). These observations also are valid in terms of essential nodes and essential branches. Thus if we let  $n_e$  represent the number of essential nodes and  $b_e$  the number of essential branches where the current is unknown, we can apply Kirchhoff's current law at  $n_e - 1$  nodes and Kirchhoff's voltage law around  $b_e - (n_e - 1)$  loops or meshes. In circuits, the number of essential nodes is less than or equal to the number of nodes, and the number of essential branches is less than or equal to the number of branches. Thus it is often convenient to use essential nodes and essential branches when analyzing a circuit, because they produce fewer independent equations to solve.

A circuit may consist of disconnected parts. An example of such a circuit is examined in Problem 4.3. The statements pertaining to the number of equations that can be derived from Kirchhoff's current law,  $n - 1$ , and voltage law,  $b - (n - 1)$ , apply to connected circuits. If a circuit has  $n$  nodes and  $b$  branches and is made up of  $s$  parts, the current law can be





**Figure 4.4** ▲ The circuit shown in Fig. 4.3 with six unknown branch currents defined.

applied  $n - s$  times, and the voltage law  $b - n + s$  times. Any two separate parts can be connected by a single conductor. This connection always causes two nodes to form one node. Moreover, no current exists in the single conductor, so any circuit made up of  $s$  disconnected parts can always be reduced to a connected circuit.

### The Systematic Approach—An Illustration

We now illustrate this systematic approach by using the circuit shown in Fig. 4.4. We write the equations on the basis of essential nodes and branches. The circuit has four essential nodes and six essential branches, denoted  $i_1 - i_6$ , for which the current is unknown.

We derive three of the six simultaneous equations needed by applying Kirchhoff's current law to any three of the four essential nodes. We use the nodes b, c, and e to get

$$\begin{aligned} -i_1 + i_2 + i_6 - I &= 0, \\ i_1 - i_3 - i_5 &= 0, \\ i_3 + i_4 - i_2 &= 0. \end{aligned} \quad (4.1)$$

We derive the remaining three equations by applying Kirchhoff's voltage law around three meshes. Because the circuit has four meshes, we need to dismiss one mesh. We choose  $R_7 - I$ , because we don't know the voltage across  $I$ .<sup>1</sup>

Using the other three meshes gives

$$\begin{aligned} R_1 i_1 + R_5 i_2 + i_3(R_2 + R_3) - v_1 &= 0, \\ -i_3(R_2 + R_3) + i_4 R_6 + i_5 R_4 - v_2 &= 0, \\ -i_2 R_5 + i_6 R_7 - i_4 R_6 &= 0. \end{aligned} \quad (4.2)$$

Rearranging Eqs. 4.1 and 4.2 to facilitate their solution yields the set

$$\begin{aligned} -i_1 + i_2 + 0i_3 + 0i_4 + 0i_5 + i_6 &= I, \\ i_1 + 0i_2 - i_3 + 0i_4 - i_5 + 0i_6 &= 0, \\ 0i_1 - i_2 + i_3 + i_4 + 0i_5 + 0i_6 &= 0, \\ R_1 i_1 + R_5 i_2 + (R_2 + R_3)i_3 + 0i_4 + 0i_5 + 0i_6 &= v_1, \\ 0i_1 + 0i_2 - (R_2 + R_3)i_3 + R_6 i_4 + R_4 i_5 + 0i_6 &= v_2, \\ 0i_1 - R_5 i_2 + 0i_3 - R_6 i_4 + 0i_5 + R_7 i_6 &= 0. \end{aligned} \quad (4.3)$$

Note that summing the current at the  $n$ th node (g in this example) gives

$$i_5 - i_4 - i_6 + I = 0. \quad (4.4)$$

<sup>1</sup> We say more about this decision in Section 4.7.



Equation 4.4 is not independent, because we can derive it by summing Eqs. 4.1 and then multiplying the sum by  $-1$ . Thus Eq. 4.4 is a linear combination of Eqs. 4.1 and therefore is not independent of them. We now carry the procedure one step further. By introducing new variables, we can describe a circuit with just  $n - 1$  equations or just  $b - (n - 1)$  equations. Therefore these new variables allow us to obtain a solution by manipulating fewer equations, a desirable goal even if a computer is to be used to obtain a numerical solution.

The new variables are known as node voltages and mesh currents. The node-voltage method enables us to describe a circuit in terms of  $n_e - 1$  equations; the mesh-current method enables us to describe a circuit in terms of  $b_e - (n_e - 1)$  equations. We begin in Section 4.2 with the node-voltage method.

*NOTE:* Assess your understanding of this material by trying Chapter Problems 4.2 and 4.3.

## 4.2 Introduction to the Node-Voltage Method

We introduce the node-voltage method by using the essential nodes of the circuit. The first step is to make a neat layout of the circuit so that no branches cross over and to mark clearly the essential nodes on the circuit diagram, as in Fig. 4.5. This circuit has three essential nodes ( $n_e = 3$ ); therefore, we need two ( $n_e - 1$ ) node-voltage equations to describe the circuit. The next step is to select one of the three essential nodes as a reference node. Although theoretically the choice is arbitrary, practically the choice for the reference node often is obvious. For example, the node with the most branches is usually a good choice. The optimum choice of the reference node (if one exists) will become apparent after you have gained some experience using this method. In the circuit shown in Fig. 4.5, the lower node connects the most branches, so we use it as the reference node. We flag the chosen reference node with the symbol  $\blacktriangledown$ , as in Fig. 4.6.

After selecting the reference node, we define the node voltages on the circuit diagram. A **node voltage** is defined as the voltage rise from the reference node to a nonreference node. For this circuit, we must define two node voltages, which are denoted  $v_1$  and  $v_2$  in Fig. 4.6.

We are now ready to generate the node-voltage equations. We do so by first writing the current leaving each branch connected to a nonreference node as a function of the node voltages and then summing these currents to zero in accordance with Kirchhoff's current law. For the circuit in Fig. 4.6, the current away from node 1 through the  $1\ \Omega$  resistor is the voltage drop across the resistor divided by the resistance (Ohm's law). The voltage drop across the resistor, in the direction of the current away from the node, is  $v_1 - 10$ . Therefore the current in the  $1\ \Omega$  resistor is  $(v_1 - 10)/1$ . Figure 4.7 depicts these observations. It shows the  $10\text{ V}-1\ \Omega$  branch, with the appropriate voltages and current.

This same reasoning yields the current in every branch where the current is unknown. Thus the current away from node 1 through the  $5\ \Omega$  resistor is  $v_1/5$ , and the current away from node 1 through the  $2\ \Omega$  resistor is  $(v_1 - v_2)/2$ . The sum of the three currents leaving node 1 must equal zero; therefore the node-voltage equation derived at node 1 is

$$\frac{v_1 - 10}{1} + \frac{v_1}{5} + \frac{v_1 - v_2}{2} = 0. \quad (4.5)$$

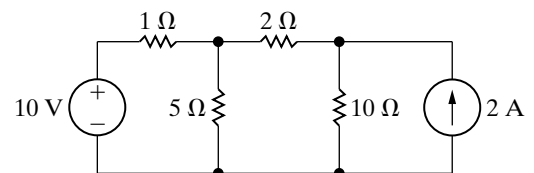


Figure 4.5 ▲ A circuit used to illustrate the node-voltage method of circuit analysis.

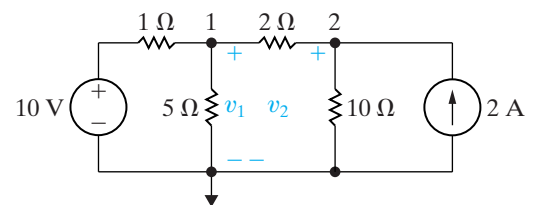


Figure 4.6 ▲ The circuit shown in Fig. 4.5 with a reference node and the node voltages.

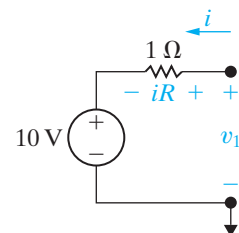


Figure 4.7 ▲ Computation of the branch current  $i$ .

The node-voltage equation derived at node 2 is

$$\frac{v_2 - v_1}{2} + \frac{v_2}{10} - 2 = 0. \quad (4.6)$$

Note that the first term in Eq. 4.6 is the current away from node 2 through the  $2\ \Omega$  resistor, the second term is the current away from node 2 through the  $10\ \Omega$  resistor, and the third term is the current away from node 2 through the current source.

Equations 4.5 and 4.6 are the two simultaneous equations that describe the circuit shown in Fig. 4.6 in terms of the node voltages  $v_1$  and  $v_2$ . Solving for  $v_1$  and  $v_2$  yields

$$v_1 = \frac{100}{11} = 9.09\ \text{V}$$

$$v_2 = \frac{120}{11} = 10.91\ \text{V}.$$

Once the node voltages are known, all the branch currents can be calculated. Once these are known, the branch voltages and powers can be calculated. Example 4.2 illustrates the use of the node-voltage method.

### Example 4.2 Using the Node-Voltage Method

- Use the node-voltage method of circuit analysis to find the branch currents  $i_a$ ,  $i_b$ , and  $i_c$  in the circuit shown in Fig. 4.8.
- Find the power associated with each source, and state whether the source is delivering or absorbing power.

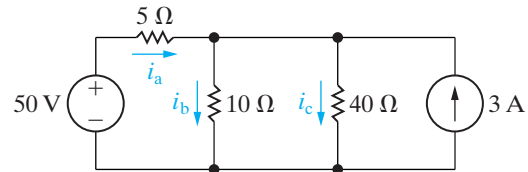


Figure 4.8 ▲ The circuit for Example 4.2.

### Solution

- We begin by noting that the circuit has two essential nodes; thus we need to write a single node-voltage expression. We select the lower node as the reference node and define the unknown node voltage as  $v_1$ . Figure 4.9 illustrates these decisions. Summing the currents away from node 1 generates the node-voltage equation

$$\frac{v_1 - 50}{5} + \frac{v_1}{10} + \frac{v_1}{40} - 3 = 0.$$

Solving for  $v_1$  gives

$$v_1 = 40\ \text{V}.$$

Hence

$$i_a = \frac{50 - 40}{5} = 2\ \text{A},$$

$$i_b = \frac{40}{10} = 4\ \text{A},$$

$$i_c = \frac{40}{40} = 1\ \text{A}.$$

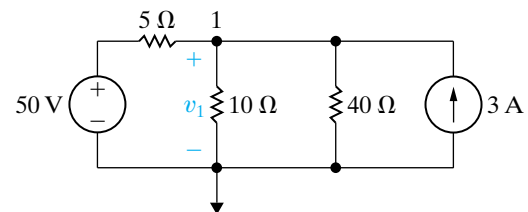


Figure 4.9 ▲ The circuit shown in Fig. 4.8 with a reference node and the unknown node voltage  $v_1$ .

- The power associated with the 50 V source is

$$p_{50\text{V}} = -50i_a = -100\ \text{W (delivering)}.$$

The power associated with the 3 A source is

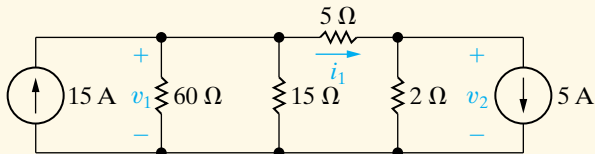
$$p_{3\text{A}} = -3v_1 = -3(40) = -120\ \text{W (delivering)}.$$

We check these calculations by noting that the total delivered power is 220 W. The total power absorbed by the three resistors is  $4(5) + 16(10) + 1(40)$ , or 220 W, as we calculated and as it must be.

## ASSESSMENT PROBLEMS

### Objective 1—Understand and be able to use the node-voltage method

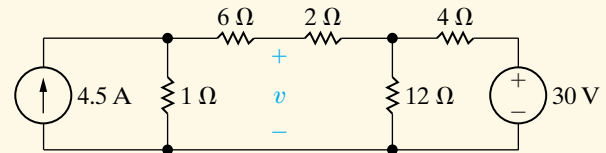
- 4.1 a) For the circuit shown, use the node-voltage method to find  $v_1$ ,  $v_2$ , and  $i_1$ .  
 b) How much power is delivered to the circuit by the 15 A source?  
 c) Repeat (b) for the 5 A source



- Answer:** (a) 60 V, 10 V, 10 A;  
 (b) 900 W;  
 (c) -50 W.

*NOTE:* Also try Chapter Problems 4.6, 4.11, and 4.13.

- 4.2 Use the node-voltage method to find  $v$  in the circuit shown.



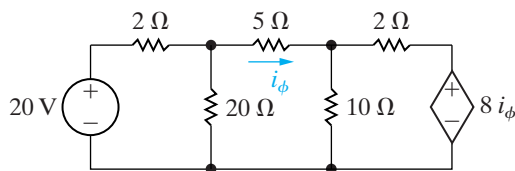
**Answer:** 15 V.

## 4.3 The Node-Voltage Method and Dependent Sources

If the circuit contains dependent sources, the node-voltage equations must be supplemented with the constraint equations imposed by the presence of the dependent sources. Example 4.3 illustrates the application of the node-voltage method to a circuit containing a dependent source.

### Example 4.3 Using the Node-Voltage Method with Dependent Sources

Use the node-voltage method to find the power dissipated in the 5 Ω resistor in the circuit shown in Fig. 4.10.



**Figure 4.10** ▲ The circuit for Example 4.3.

### Solution

We begin by noting that the circuit has three essential nodes. Hence we need two node-voltage equations to describe the circuit. Four branches terminate

on the lower node, so we select it as the reference node. The two unknown node voltages are defined on the circuit shown in Fig. 4.11. Summing the currents away from node 1 generates the equation

$$\frac{v_1 - 20}{2} + \frac{v_1}{20} + \frac{v_1 - v_2}{5} = 0.$$

Summing the currents away from node 2 yields

$$\frac{v_2 - v_1}{5} + \frac{v_2}{10} + \frac{v_2 - 8i_\phi}{2} = 0.$$

As written, these two node-voltage equations contain three unknowns, namely,  $v_1$ ,  $v_2$ , and  $i_\phi$ . To eliminate  $i_\phi$  we must express this controlling current in terms of the node voltages, or

$$i_\phi = \frac{v_1 - v_2}{5}.$$

Substituting this relationship into the node 2 equation simplifies the two node-voltage equations to

$$\begin{aligned} 0.75v_1 - 0.2v_2 &= 10, \\ -v_1 + 1.6v_2 &= 0. \end{aligned}$$

Solving for  $v_1$  and  $v_2$  gives

$$v_1 = 16 \text{ V}$$

and

$$v_2 = 10 \text{ V}.$$

Then,

$$i_\phi = \frac{16 - 10}{5} = 1.2 \text{ A},$$

$$p_{5\Omega} = (1.2)(5) = 6 \text{ W}.$$

A good exercise to build your problem-solving intuition is to reconsider this example, using node 2 as the reference node. Does it make the analysis easier or harder?

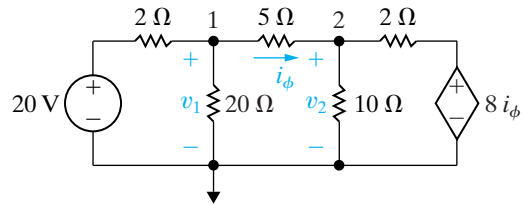


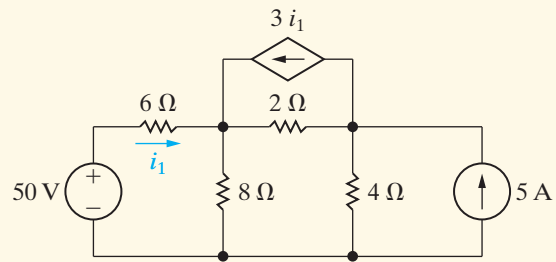
Figure 4.11 ▲ The circuit shown in Fig. 4.10, with a reference node and the node voltages.

### ASSESSMENT PROBLEM

#### Objective 1—Understand and be able to use the node-voltage method

- 4.3 a) Use the node-voltage method to find the power associated with each source in the circuit shown.  
 b) State whether the source is delivering power to the circuit or extracting power from the circuit.

**Answer:** (a)  $p_{50V} = -150 \text{ W}$ ,  $p_{3i_1} = -144 \text{ W}$ ,  
 $p_{5A} = -80 \text{ W}$ ;  
 (b) all sources are delivering power to the circuit.



NOTE: Also try Chapter Problems 4.18 and 4.19.

## 4.4 The Node-Voltage Method: Some Special Cases

When a voltage source is the only element between two essential nodes, the node-voltage method is simplified. As an example, look at the circuit in Fig. 4.12. There are three essential nodes in this circuit, which means that two simultaneous equations are needed. From these three essential nodes, a reference node has been chosen and two other nodes have been labeled. But the 100 V source constrains the voltage between node 1 and the reference node to 100 V. This means that there is only one unknown node voltage ( $v_2$ ). Solution of this circuit thus involves only a single node-voltage equation at node 2:

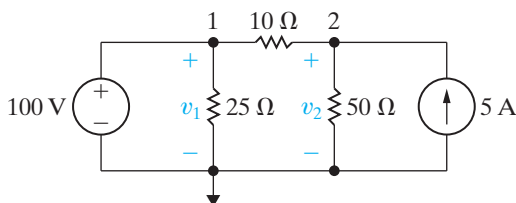


Figure 4.12 ▲ A circuit with a known node voltage.

$$\frac{v_2 - v_1}{10} + \frac{v_2}{50} - 5 = 0. \tag{4.7}$$

But  $v_1 = 100 \text{ V}$ , so Eq. 4.7 can be solved for  $v_2$ :

$$v_2 = 125 \text{ V}. \tag{4.8}$$

Knowing  $v_2$ , we can calculate the current in every branch. You should verify that the current into node 1 in the branch containing the independent voltage source is 1.5 A.

In general, when you use the node-voltage method to solve circuits that have voltage sources connected directly between essential nodes, the number of unknown node voltages is reduced. The reason is that, whenever a voltage source connects two essential nodes, it constrains the difference between the node voltages at these nodes to equal the voltage of the source. Taking the time to see if you can reduce the number of unknowns in this way will simplify circuit analysis.

Suppose that the circuit shown in Fig. 4.13 is to be analyzed using the node-voltage method. The circuit contains four essential nodes, so we anticipate writing three node-voltage equations. However, two essential nodes are connected by an independent voltage source, and two other essential nodes are connected by a current-controlled dependent voltage source. Hence, there actually is only one unknown node voltage.

Choosing which node to use as the reference node involves several possibilities. Either node on each side of the dependent voltage source looks attractive because, if chosen, one of the node voltages would be known to be either  $+10i_\phi$  (left node is the reference) or  $-10i_\phi$  (right node is the reference). The lower node looks even better because one node voltage is immediately known (50 V) and five branches terminate there. We therefore opt for the lower node as the reference.

Figure 4.14 shows the redrawn circuit, with the reference node flagged and the node voltages defined. Also, we introduce the current  $i$  because we cannot express the current in the dependent voltage source branch as a function of the node voltages  $v_2$  and  $v_3$ . Thus, at node 2

$$\frac{v_2 - v_1}{5} + \frac{v_2}{40} + i = 0, \quad (4.9)$$

and at node 3

$$\frac{v_3}{100} - i - 4 = 0. \quad (4.10)$$

We eliminate  $i$  simply by adding Eqs. 4.9 and 4.10 to get

$$\frac{v_2 - v_1}{5} + \frac{v_2}{40} + \frac{v_3}{100} - 4 = 0. \quad (4.11)$$

## The Concept of a Supernode

Equation 4.11 may be written directly, without resorting to the intermediate step represented by Eqs. 4.9 and 4.10. To do so, we consider nodes 2 and 3 to be a single node and simply sum the currents away from the node in terms of the node voltages  $v_2$  and  $v_3$ . Figure 4.15 illustrates this approach.

When a voltage source is between two essential nodes, we can combine those nodes to form a **supernode**. Obviously, Kirchhoff's current law must hold for the supernode. In Fig. 4.15, starting with the  $5\ \Omega$  branch and moving counterclockwise around the supernode, we generate the equation

$$\frac{v_2 - v_1}{5} + \frac{v_2}{40} + \frac{v_3}{100} - 4 = 0, \quad (4.12)$$

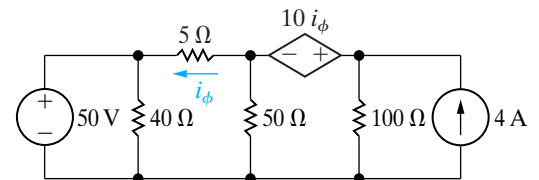


Figure 4.13 ▲ A circuit with a dependent voltage source connected between nodes.

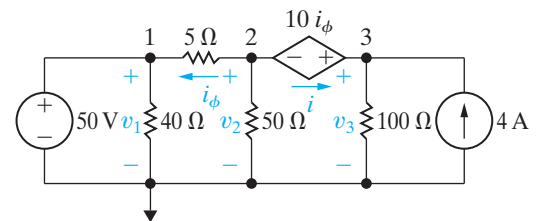


Figure 4.14 ▲ The circuit shown in Fig. 4.13, with the selected node voltages defined.

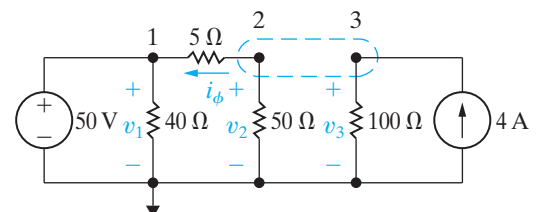


Figure 4.15 ▲ Considering nodes 2 and 3 to be a supernode.

which is identical to Eq. 4.11. Creating a supernode at nodes 2 and 3 has made the task of analyzing this circuit easier. It is therefore always worth taking the time to look for this type of shortcut before writing any equations.

After Eq. 4.12 has been derived, the next step is to reduce the expression to a single unknown node voltage. First we eliminate  $v_1$  from the equation because we know that  $v_1 = 50$  V. Next we express  $v_3$  as a function of  $v_2$ :

$$v_3 = v_2 + 10i_\phi \tag{4.13}$$

We now express the current controlling the dependent voltage source as a function of the node voltages:

$$i_\phi = \frac{v_2 - 50}{5} \tag{4.14}$$

Using Eqs. 4.13 and 4.14 and  $v_1 = 50$  V reduces Eq. 4.12 to

$$\begin{aligned} v_2 \left( \frac{1}{50} + \frac{1}{5} + \frac{1}{100} + \frac{10}{500} \right) &= 10 + 4 + 1, \\ v_2(0.25) &= 15, \\ v_2 &= 60 \text{ V}. \end{aligned}$$

From Eqs. 4.13 and 4.14:

$$\begin{aligned} i_\phi &= \frac{60 - 50}{5} = 2 \text{ A}, \\ v_3 &= 60 + 20 = 80 \text{ V}. \end{aligned}$$

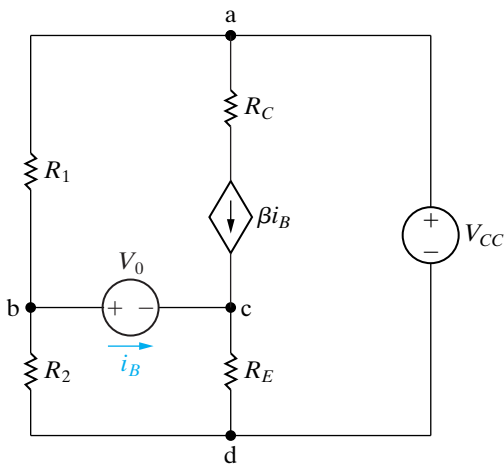


Figure 4.16 ▲ The transistor amplifier circuit shown in Fig. 2.24.

### Node-Voltage Analysis of the Amplifier Circuit

Let's use the node-voltage method to analyze the circuit first introduced in Section 2.5 and shown again in Fig. 4.16.

When we used the branch-current method of analysis in Section 2.5, we faced the task of writing and solving six simultaneous equations. Here we will show how nodal analysis can simplify our task.

The circuit has four essential nodes: Nodes a and d are connected by an independent voltage source as are nodes b and c. Therefore the problem reduces to finding a single unknown node voltage, because  $(n_e - 1) - 2 = 1$ . Using d as the reference node, combine nodes b and c into a supernode, label the voltage drop across  $R_2$  as  $v_b$ , and label the voltage drop across  $R_E$  as  $v_c$ , as shown in Fig. 4.17. Then,

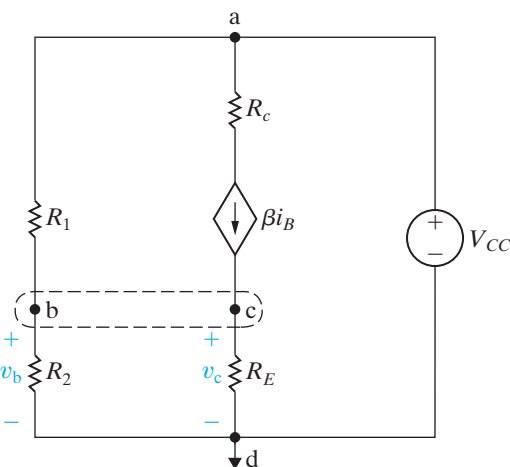


Figure 4.17 ▲ The circuit shown in Fig. 4.16, with voltages and the supernode identified.

$$\frac{v_b}{R_2} + \frac{v_b - V_{CC}}{R_1} + \frac{v_c}{R_E} - \beta i_B = 0. \tag{4.15}$$

We now eliminate both  $v_c$  and  $i_B$  from Eq. 4.15 by noting that

$$v_c = (i_B + \beta i_B)R_E, \tag{4.16}$$

$$v_c = v_b - V_0. \tag{4.17}$$

Substituting Eqs. 4.16 and 4.17 into Eq. 4.15 yields

$$v_b \left[ \frac{1}{R_1} + \frac{1}{R_2} + \frac{1}{(1 + \beta)R_E} \right] = \frac{V_{CC}}{R_1} + \frac{V_0}{(1 + \beta)R_E}. \quad (4.18)$$

Solving Eq. 4.18 for  $v_b$  yields

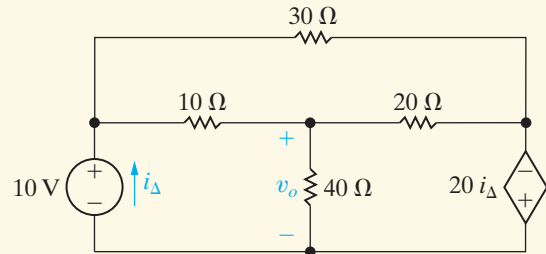
$$v_b = \frac{V_{CC}R_2(1 + \beta)R_E + V_0R_1R_2}{R_1R_2 + (1 + \beta)R_ER_1 + R_2}. \quad (4.19)$$

Using the node-voltage method to analyze this circuit reduces the problem from manipulating six simultaneous equations (see Problem 2.27) to manipulating three simultaneous equations. You should verify that, when Eq. 4.19 is combined with Eqs. 4.16 and 4.17, the solution for  $i_B$  is identical to Eq. 2.25. (See Problem 4.30.)

### ASSESSMENT PROBLEMS

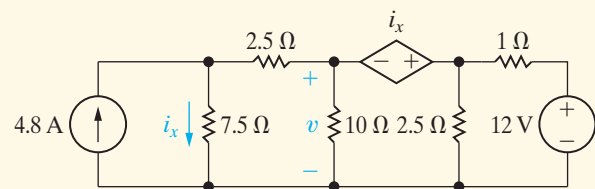
#### Objective 1—Understand and be able to use the node-voltage method

- 4.4 Use the node-voltage method to find  $v_o$  in the circuit shown.



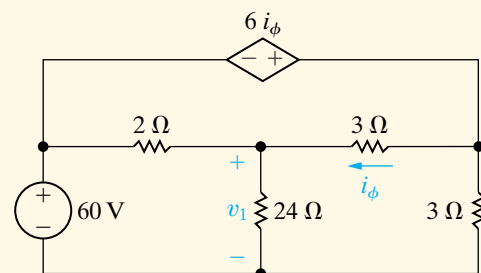
Answer: 24 V.

- 4.5 Use the node-voltage method to find  $v$  in the circuit shown.



Answer: 8 V.

- 4.6 Use the node-voltage method to find  $v_1$  in the circuit shown.



Answer: 48 V.

NOTE: Also try Chapter Problems 4.22, 4.23, and 4.26.

## 4.5 Introduction to the Mesh-Current Method

As stated in Section 4.1, the mesh-current method of circuit analysis enables us to describe a circuit in terms of  $b_e - (n_e - 1)$  equations. Recall that a mesh is a loop with no other loops inside it. The circuit in Fig. 4.1(b) is shown again in Fig. 4.18, with current arrows inside each loop to distinguish it. Recall also that the mesh-current method is applicable only to planar circuits. The

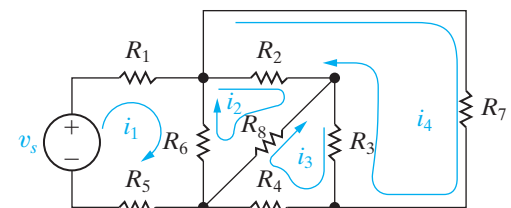


Figure 4.18 ▲ The circuit shown in Fig. 4.1(b), with the mesh currents defined.



circuit in Fig. 4.18 contains seven essential branches where the current is unknown and four essential nodes. Therefore, to solve it via the mesh-current method, we must write four  $[7 - (4 - 1)]$  mesh-current equations.

A **mesh current** is the current that exists only in the perimeter of a mesh. On a circuit diagram it appears as either a closed solid line or an almost-closed solid line that follows the perimeter of the appropriate mesh. An arrowhead on the solid line indicates the reference direction for the mesh current. Figure 4.18 shows the four mesh currents that describe the circuit in Fig. 4.1(b). Note that by definition, mesh currents automatically satisfy Kirchhoff's current law. That is, at any node in the circuit, a given mesh current both enters and leaves the node.

Figure 4.18 also shows that identifying a mesh current in terms of a branch current is not always possible. For example, the mesh current  $i_2$  is not equal to any branch current, whereas mesh currents  $i_1, i_3,$  and  $i_4$  can be identified with branch currents. Thus measuring a mesh current is not always possible; note that there is no place where an ammeter can be inserted to measure the mesh current  $i_2$ . The fact that a mesh current can be a fictitious quantity doesn't mean that it is a useless concept. On the contrary, the mesh-current method of circuit analysis evolves quite naturally from the branch-current equations.

We can use the circuit in Fig. 4.19 to show the evolution of the mesh-current technique. We begin by using the branch currents ( $i_1, i_2,$  and  $i_3$ ) to formulate the set of independent equations. For this circuit,  $b_e = 3$  and  $n_e = 2$ . We can write only one independent current equation, so we need two independent voltage equations. Applying Kirchhoff's current law to the upper node and Kirchhoff's voltage law around the two meshes generates the following set of equations:

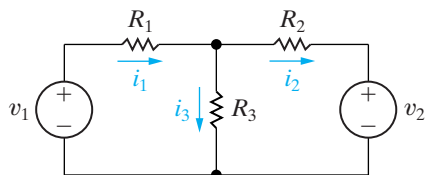


Figure 4.19 ▲ A circuit used to illustrate development of the mesh-current method of circuit analysis.

$$i_1 = i_2 + i_3, \tag{4.20}$$

$$v_1 = i_1 R_1 + i_3 R_3, \tag{4.21}$$

$$-v_2 = i_2 R_2 - i_3 R_3. \tag{4.22}$$

We reduce this set of three equations to a set of two equations by solving Eq. 4.20 for  $i_3$  and then substituting this expression into Eqs. 4.21 and 4.22:

$$v_1 = i_1(R_1 + R_3) - i_2 R_3, \tag{4.23}$$

$$-v_2 = -i_1 R_3 + i_2(R_2 + R_3). \tag{4.24}$$

We can solve Eqs. 4.23 and 4.24 for  $i_1$  and  $i_2$  to replace the solution of three simultaneous equations with the solution of two simultaneous equations. We derived Eqs. 4.23 and 4.24 by substituting the  $n_e - 1$  current equations into the  $b_e - (n_e - 1)$  voltage equations. The value of the mesh-current method is that, by defining mesh currents, we automatically eliminate the  $n_e - 1$  current equations. Thus the mesh-current method is equivalent to a systematic substitution of the  $n_e - 1$  current equations into the  $b_e - (n_e - 1)$  voltage equations. The mesh currents in Fig. 4.19 that are equivalent to eliminating the branch current  $i_3$  from Eqs. 4.21 and 4.22 are shown in Fig. 4.20. We now apply Kirchhoff's voltage law around the two meshes, expressing all voltages across resistors in terms of the mesh currents, to get the equations

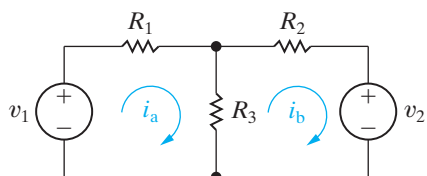


Figure 4.20 ▲ Mesh currents  $i_a$  and  $i_b$ .

$$v_1 = i_a R_1 + (i_a - i_b) R_3, \tag{4.25}$$

$$-v_2 = (i_b - i_a) R_3 + i_b R_2. \tag{4.26}$$

Collecting the coefficients of  $i_a$  and  $i_b$  in Eqs. 4.25 and 4.26 gives

$$v_1 = i_a(R_1 + R_3) - i_b R_3, \tag{4.27}$$

$$-v_2 = -i_a R_3 + i_b(R_2 + R_3). \tag{4.28}$$

Note that Eqs. 4.27 and 4.28 and Eqs. 4.23 and 4.24 are identical in form, with the mesh currents  $i_a$  and  $i_b$  replacing the branch currents  $i_1$  and  $i_2$ . Note also that the branch currents shown in Fig. 4.19 can be expressed in terms of the mesh currents shown in Fig. 4.20, or

$$i_1 = i_a, \quad (4.29)$$

$$i_2 = i_b, \quad (4.30)$$

$$i_3 = i_a - i_b. \quad (4.31)$$

The ability to write Eqs. 4.29–4.31 by inspection is crucial to the mesh-current method of circuit analysis. Once you know the mesh currents, you also know the branch currents. And once you know the branch currents, you can compute any voltages or powers of interest.

Example 4.4 illustrates how the mesh-current method is used to find source powers and a branch voltage.

### Example 4.4 Using the Mesh-Current Method

- Use the mesh-current method to determine the power associated with each voltage source in the circuit shown in Fig. 4.21.
- Calculate the voltage  $v_o$  across the  $8\ \Omega$  resistor.

#### Solution

- To calculate the power associated with each source, we need to know the current in each source. The circuit indicates that these source currents will be identical to mesh currents. Also, note that the circuit has seven branches where

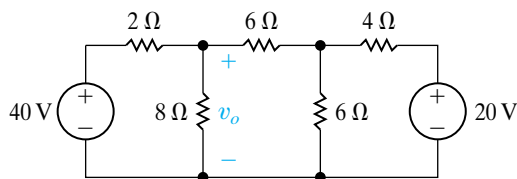


Figure 4.21 ▲ The circuit for Example 4.4.

the current is unknown and five nodes. Therefore we need three  $[b - (n - 1) = 7 - (5 - 1)]$  mesh-current equations to describe the circuit. Figure 4.22 shows the three mesh currents used to describe the circuit in Fig. 4.21. If we assume that the voltage drops are positive, the three mesh equations are

$$-40 + 2i_a + 8(i_a - i_b) = 0,$$

$$8(i_b - i_a) + 6i_b + 6(i_b - i_c) = 0,$$

$$6(i_c - i_b) + 4i_c + 20 = 0. \quad (4.32)$$

Your calculator can probably solve these equations, or you can use a computer tool. Cramer's method is a useful tool when solving three or more simultaneous equations by hand. You can review this important tool in Appendix A. Reorganizing Eqs. 4.32 in anticipation of using your calculator, a computer program, or Cramer's method gives

$$10i_a - 8i_b + 0i_c = 40;$$

$$-8i_a + 20i_b - 6i_c = 0;$$

$$0i_a - 6i_b + 10i_c = -20. \quad (4.33)$$

The three mesh currents are

$$i_a = 5.6\ \text{A},$$

$$i_b = 2.0\ \text{A},$$

$$i_c = -0.80\ \text{A}.$$

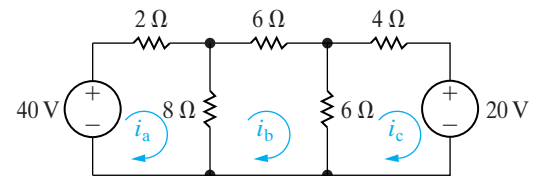


Figure 4.22 ▲ The three mesh currents used to analyze the circuit shown in Fig. 4.21.

The mesh current  $i_a$  is identical with the branch current in the  $40\ \text{V}$  source, so the power associated with this source is

$$p_{40\text{V}} = -40i_a = -224\ \text{W}.$$

The minus sign means that this source is delivering power to the network. The current in the 20 V source is identical to the mesh current  $i_c$ ; therefore

$$p_{20V} = 20i_c = -16 \text{ W.}$$

The 20 V source also is delivering power to the network.

- b) The branch current in the 8  $\Omega$  resistor in the direction of the voltage drop  $v_o$  is  $i_a - i_b$ . Therefore

$$v_o = 8(i_a - i_b) = 8(3.6) = 28.8 \text{ V.}$$

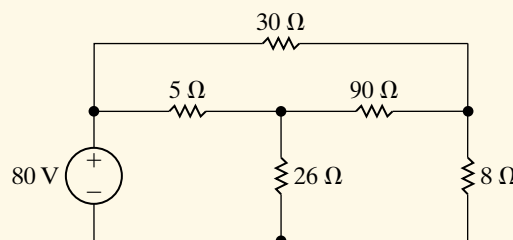
## ASSESSMENT PROBLEM

### Objective 2—Understand and be able to use the mesh-current method

- 4.7 Use the mesh-current method to find (a) the power delivered by the 80 V source to the circuit shown and (b) the power dissipated in the 8  $\Omega$  resistor.

**Answer:** (a) 400 W;  
(b) 50 W.

*NOTE:* Also try Chapter Problems 4.32 and 4.36.

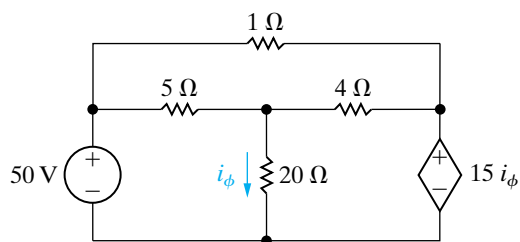


## 4.6 The Mesh-Current Method and Dependent Sources

If the circuit contains dependent sources, the mesh-current equations must be supplemented by the appropriate constraint equations. Example 4.5 illustrates the application of the mesh-current method when the circuit includes a dependent source.

### Example 4.5 Using the Mesh-Current Method with Dependent Sources

Use the mesh-current method of circuit analysis to determine the power dissipated in the 4  $\Omega$  resistor in the circuit shown in Fig. 4.23.



**Figure 4.23** ▲ The circuit for Example 4.5.

### Solution

This circuit has six branches where the current is unknown and four nodes. Therefore we need three mesh currents to describe the circuit. They are

defined on the circuit shown in Fig. 4.24. The three mesh-current equations are

$$50 = 5(i_1 - i_2) + 20(i_1 - i_3),$$

$$0 = 5(i_2 - i_1) + 1i_2 + 4(i_2 - i_3),$$

$$0 = 20(i_3 - i_1) + 4(i_3 - i_2) + 15i_\phi. \quad (4.34)$$

We now express the branch current controlling the dependent voltage source in terms of the mesh currents as

$$i_\phi = i_1 - i_3, \quad (4.35)$$

which is the supplemental equation imposed by the presence of the dependent source. Substituting Eq. 4.35 into Eqs. 4.34 and collecting the coefficients of  $i_1$ ,  $i_2$ , and  $i_3$  in each equation generates

$$50 = 25i_1 - 5i_2 - 20i_3,$$

$$0 = -5i_1 + 10i_2 - 4i_3,$$

$$0 = -5i_1 - 4i_2 + 9i_3.$$

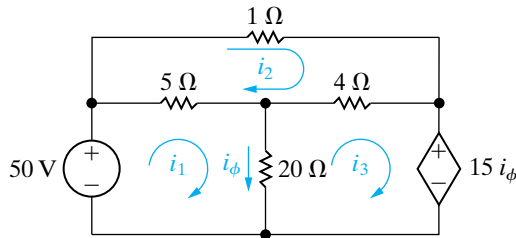


Figure 4.24 ▲ The circuit shown in Fig. 4.23 with the three mesh currents.

Because we are calculating the power dissipated in the  $4\ \Omega$  resistor, we compute the mesh currents  $i_2$  and  $i_3$ :

$$i_2 = 26\ \text{A},$$

$$i_3 = 28\ \text{A}.$$

The current in the  $4\ \Omega$  resistor oriented from left to right is  $i_3 - i_2$ , or  $2\ \text{A}$ . Therefore the power dissipated is

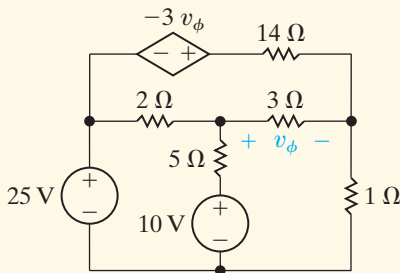
$$p_{4\Omega} = (i_3 - i_2)^2(4) = (2)^2(4) = 16\ \text{W}.$$

What if you had not been told to use the mesh-current method? Would you have chosen the node-voltage method? It reduces the problem to finding one unknown node voltage because of the presence of two voltage sources between essential nodes. We present more about making such choices later.

### ASSESSMENT PROBLEMS

#### Objective 2—Understand and be able to use the mesh-current method

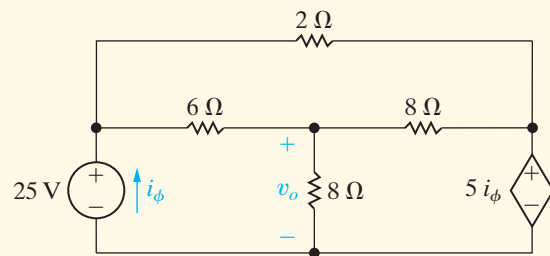
- 4.8 a) Determine the number of mesh-current equations needed to solve the circuit shown.  
 b) Use the mesh-current method to find how much power is being delivered to the dependent voltage source.



NOTE: Also try Chapter Problems 4.39 and 4.40.

Answer: (a) 3;  
 (b)  $-36\ \text{W}$ .

- 4.9 Use the mesh-current method to find  $v_o$  in the circuit shown.



Answer:  $16\ \text{V}$ .

## 4.7 The Mesh-Current Method: Some Special Cases

When a branch includes a current source, the mesh-current method requires some additional manipulations. The circuit shown in Fig. 4.25 depicts the nature of the problem.

We have defined the mesh currents  $i_a$ ,  $i_b$ , and  $i_c$ , as well as the voltage across the  $5\ \text{A}$  current source, to aid the discussion. Note that the circuit contains five essential branches where the current is unknown and four essential nodes. Hence we need to write two  $[5 - (4 - 1)]$  mesh-current

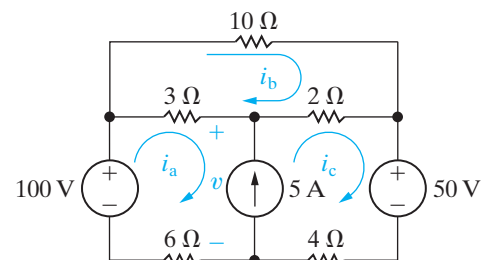


Figure 4.25 ▲ A circuit illustrating mesh analysis when a branch contains an independent current source.

equations to solve the circuit. The presence of the current source reduces the three unknown mesh currents to two such currents, because it constrains the difference between  $i_a$  and  $i_c$  to equal 5 A. Hence, if we know  $i_a$ , we know  $i_c$ , and vice versa.

However, when we attempt to sum the voltages around either mesh a or mesh c, we must introduce into the equations the unknown voltage across the 5 A current source. Thus, for mesh a:

$$100 = 3(i_a - i_b) + v + 6i_a, \quad (4.36)$$

and for mesh c:

$$-50 = 4i_c - v + 2(i_c - i_b). \quad (4.37)$$

We now add Eqs. 4.36 and 4.37 to eliminate  $v$  and obtain

$$50 = 9i_a - 5i_b + 6i_c. \quad (4.38)$$

Summing voltages around mesh b gives

$$0 = 3(i_b - i_a) + 10i_b + 2(i_b - i_c). \quad (4.39)$$

We reduce Eqs. 4.38 and 4.39 to two equations and two unknowns by using the constraint that

$$i_c - i_a = 5. \quad (4.40)$$

We leave to you the verification that, when Eq. 4.40 is combined with Eqs. 4.38 and 4.39, the solutions for the three mesh currents are

$$i_a = 1.75 \text{ A}, \quad i_b = 1.25 \text{ A}, \quad \text{and} \quad i_c = 6.75 \text{ A}.$$

## The Concept of a Supermesh

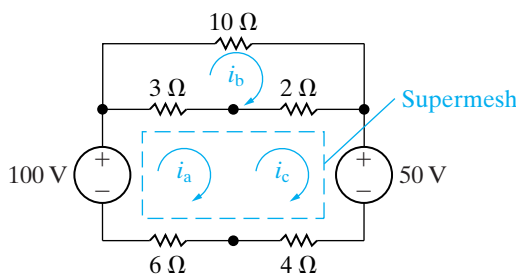
We can derive Eq. 4.38 without introducing the unknown voltage  $v$  by using the concept of a supermesh. To create a supermesh, we mentally remove the current source from the circuit by simply avoiding this branch when writing the mesh-current equations. We express the voltages around the supermesh in terms of the original mesh currents. Figure 4.26 illustrates the supermesh concept. When we sum the voltages around the supermesh (denoted by the dashed line), we obtain the equation

$$-100 + 3(i_a - i_b) + 2(i_c - i_b) + 50 + 4i_c + 6i_a = 0, \quad (4.41)$$

which reduces to

$$50 = 9i_a - 5i_b + 6i_c. \quad (4.42)$$

Note that Eqs. 4.42 and 4.38 are identical. Thus the supermesh has eliminated the need for introducing the unknown voltage across the current source. Once again, taking time to look carefully at a circuit to identify a shortcut such as this provides a big payoff in simplifying the analysis.



**Figure 4.26** ▲ The circuit shown in Fig. 4.25, illustrating the concept of a supermesh.

### Mesh-Current Analysis of the Amplifier Circuit

We can use the circuit first introduced in Section 2.5 (Fig. 2.24) to illustrate how the mesh-current method works when a branch contains a dependent current source. Figure 4.27 shows that circuit, with the three mesh currents denoted  $i_a$ ,  $i_b$ , and  $i_c$ . This circuit has four essential nodes and five essential branches where the current is unknown. Therefore we know that the circuit can be analyzed in terms of two  $[5 - (4 - 1)]$  mesh-current equations. Although we defined three mesh currents in Fig. 4.27, the dependent current source forces a constraint between mesh currents  $i_a$  and  $i_c$ , so we have only two unknown mesh currents. Using the concept of the supermesh, we redraw the circuit as shown in Fig. 4.28.

We now sum the voltages around the supermesh in terms of the mesh currents  $i_a$ ,  $i_b$ , and  $i_c$  to obtain

$$R_1 i_a + v_{CC} + R_E (i_c - i_b) - V_0 = 0. \quad (4.43)$$

The mesh b equation is

$$R_2 i_b + V_0 + R_E (i_b - i_c) = 0. \quad (4.44)$$

The constraint imposed by the dependent current source is

$$\beta i_B = i_a - i_c. \quad (4.45)$$

The branch current controlling the dependent current source, expressed as a function of the mesh currents, is

$$i_B = i_b - i_a. \quad (4.46)$$

From Eqs. 4.45 and 4.46,

$$i_c = (1 + \beta) i_a - \beta i_b. \quad (4.47)$$

We now use Eq. 4.47 to eliminate  $i_c$  from Eqs. 4.43 and 4.44:

$$[R_1 + (1 + \beta) R_E] i_a - (1 + \beta) R_E i_b = V_0 - V_{CC}, \quad (4.48)$$

$$-(1 + \beta) R_E i_a + [R_2 + (1 + \beta) R_E] i_b = -V_0. \quad (4.49)$$

You should verify that the solution of Eqs. 4.48 and 4.49 for  $i_a$  and  $i_b$  gives

$$i_a = \frac{V_0 R_2 - V_{CC} R_2 - V_{CC} (1 + \beta) R_E}{R_1 R_2 + (1 + \beta) R_E (R_1 + R_2)}, \quad (4.50)$$

$$i_b = \frac{-V_0 R_1 - (1 + \beta) R_E V_{CC}}{R_1 R_2 + (1 + \beta) R_E (R_1 + R_2)}. \quad (4.51)$$

We also leave you to verify that, when Eqs. 4.50 and 4.51 are used to find  $i_B$ , the result is the same as that given by Eq. 2.25.

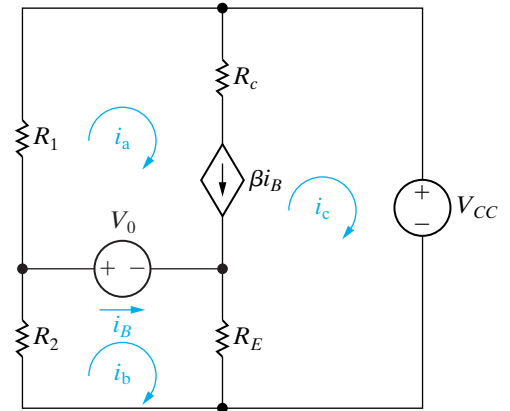


Figure 4.27 ▲ The circuit shown in Fig. 2.24 with the mesh currents  $i_a$ ,  $i_b$ , and  $i_c$ .

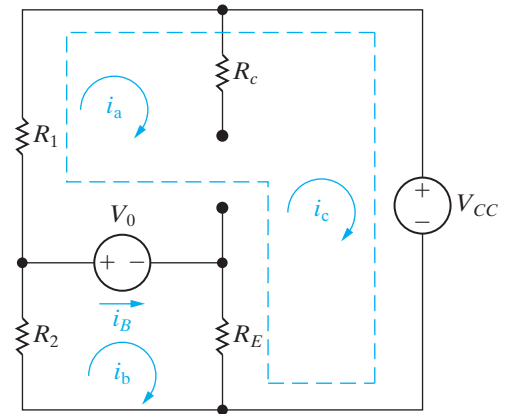
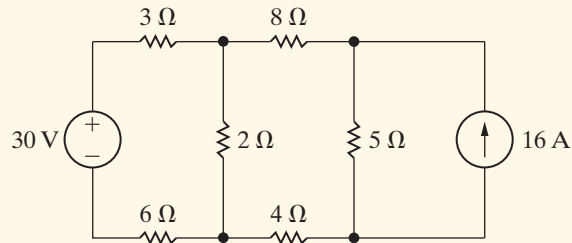


Figure 4.28 ▲ The circuit shown in Fig. 4.27, depicting the supermesh created by the presence of the dependent current source.

## ASSESSMENT PROBLEMS

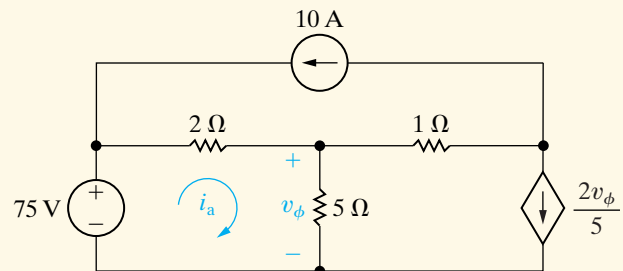
### Objective 2—Understand and be able to use the mesh-current method

- 4.10 Use the mesh-current method to find the power dissipated in the  $2\ \Omega$  resistor in the circuit shown.



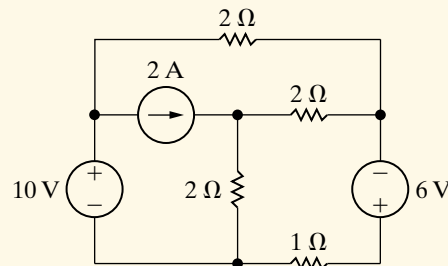
Answer: 72 W.

- 4.11 Use the mesh-current method to find the mesh current  $i_a$  in the circuit shown.



Answer: 15 A.

- 4.12 Use the mesh-current method to find the power dissipated in the  $1\ \Omega$  resistor in the circuit shown.



Answer: 36 W.

NOTE: Also try Chapter Problems 4.43, 4.47, 4.49, and 4.52.

## 4.8 The Node-Voltage Method Versus the Mesh-Current Method

The greatest advantage of both the node-voltage and mesh-current methods is that they reduce the number of simultaneous equations that must be manipulated. They also require the analyst to be quite systematic in terms of organizing and writing these equations. It is natural to ask, then, “When is the node-voltage method preferred to the mesh-current method and vice versa?” As you might suspect, there is no clear-cut answer. Asking a number of questions, however, may help you identify the more efficient method before plunging into the solution process:

- Does one of the methods result in fewer simultaneous equations to solve?
- Does the circuit contain supernodes? If so, using the node-voltage method will permit you to reduce the number of equations to be solved.



- Does the circuit contain supermeshes? If so, using the mesh-current method will permit you to reduce the number of equations to be solved.
- Will solving some portion of the circuit give the requested solution? If so, which method is most efficient for solving just the pertinent portion of the circuit?

Perhaps the most important observation is that, for any situation, some time spent thinking about the problem in relation to the various analytical approaches available is time well spent. Examples 4.6 and 4.7 illustrate the process of deciding between the node-voltage and mesh-current methods.

### Example 4.6 Understanding the Node-Voltage Method Versus Mesh-Current Method

Find the power dissipated in the  $300\ \Omega$  resistor in the circuit shown in Fig. 4.29.

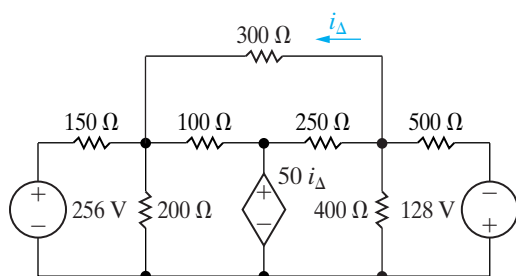


Figure 4.29 ▲ The circuit for Example 4.6.

#### Solution

To find the power dissipated in the  $300\ \Omega$  resistor, we need to find either the current in the resistor or the voltage across it. The mesh-current method yields the current in the resistor; this approach requires solving five simultaneous mesh equations, as depicted in Fig. 4.30. In writing the five equations, we must include the constraint  $i_{\Delta} = -i_b$ .

Before going further, let's also look at the circuit in terms of the node-voltage method. Note that, once we know the node voltages, we can calculate either the current in the  $300\ \Omega$  resistor or the voltage across it. The circuit has four essential nodes, and therefore only three node-voltage equations are required to describe the circuit. Because of the dependent voltage source between two essential nodes, we have to sum the currents at only two nodes. Hence the problem is reduced to writing two node-voltage equations and a constraint equation. Because the node-voltage method requires only three simultaneous equations, it is the more attractive approach.

Once the decision to use the node-voltage method has been made, the next step is to select a reference node. Two essential nodes in the circuit in Fig. 4.29 merit consideration. The first is the reference node in Fig. 4.31. If this node is selected, one of the unknown node voltages is the voltage across the

$300\ \Omega$  resistor, namely,  $v_2$  in Fig. 4.31. Once we know this voltage, we calculate the power in the  $300\ \Omega$  resistor by using the expression

$$p_{300\Omega} = v_2^2/300.$$

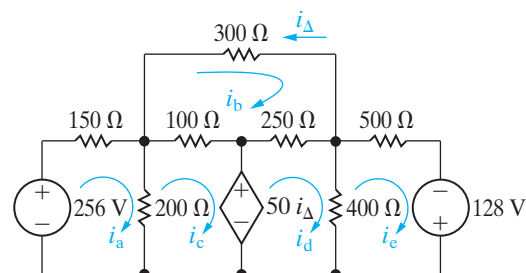


Figure 4.30 ▲ The circuit shown in Fig. 4.29, with the five mesh currents.

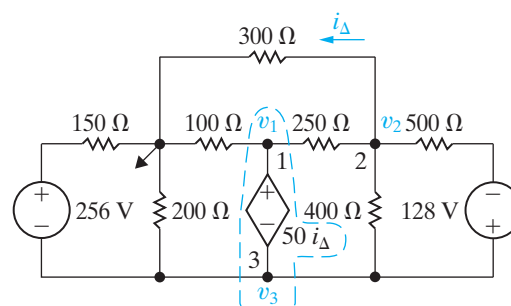
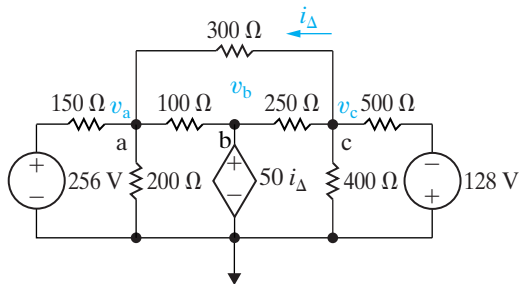


Figure 4.31 ▲ The circuit shown in Fig. 4.29, with a reference node.

Note that, in addition to selecting the reference node, we defined the three node voltages  $v_1$ ,  $v_2$ , and  $v_3$  and indicated that nodes 1 and 3 form a super-node, because they are connected by a dependent voltage source. It is understood that a node voltage is a rise from the reference node; therefore, in Fig. 4.31, we have not placed the node voltage polarity references on the circuit diagram.

The second node that merits consideration as the reference node is the lower node in the circuit, as shown in Fig. 4.32. It is attractive because it has the most branches connected to it, and the node-voltage equations are thus easier to write. However, to find either the current in the 300 Ω resistor or the voltage across it requires an additional calculation once we know the node voltages  $v_a$  and  $v_c$ . For example, the current in the 300 Ω resistor is  $(v_c - v_a)/300$ , whereas the voltage across the resistor is  $v_c - v_a$ .



**Figure 4.32** ▲ The circuit shown in Fig. 4.29 with an alternative reference node.

We compare these two possible reference nodes by means of the following sets of equations. The first set pertains to the circuit shown in Fig. 4.31, and the second set is based on the circuit shown in Fig. 4.32.

- Set 1 (Fig 4.31)  
At the supernode,

$$\frac{v_1}{100} + \frac{v_1 - v_2}{250} + \frac{v_3}{200} + \frac{v_3 - v_2}{400} + \frac{v_3 - (v_2 + 128)}{500}$$

$$+ \frac{v_3 + 256}{150} = 0.$$

At  $v_2$ ,

$$\frac{v_2}{300} + \frac{v_2 - v_1}{250} + \frac{v_2 - v_3}{400} + \frac{v_2 + 128 - v_3}{500} = 0.$$

From the supernode, the constraint equation is

$$v_3 = v_1 - 50i_\Delta = v_1 - \frac{v_2}{6}.$$

- Set 2 (Fig 4.32)  
At  $v_a$ ,

$$\frac{v_a}{200} + \frac{v_a - 256}{150} + \frac{v_a - v_b}{100} + \frac{v_a - v_c}{300} = 0.$$

At  $v_c$ ,

$$\frac{v_c}{400} + \frac{v_c + 128}{500} + \frac{v_c - v_b}{250} + \frac{v_c - v_a}{300} = 0.$$

From the supernode, the constraint equation is

$$v_b = 50i_\Delta = \frac{50(v_c - v_a)}{300} = \frac{v_c - v_a}{6}.$$

You should verify that the solution of either set leads to a power calculation of 16.57 W dissipated in the 300 Ω resistor.

**Example 4.7** Comparing the Node-Voltage and Mesh-Current Methods

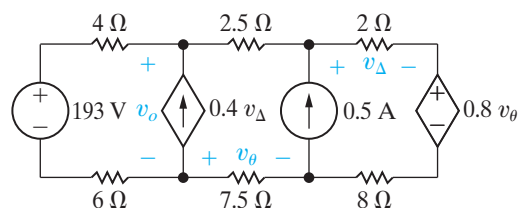
Find the voltage  $v_o$  in the circuit shown in Fig. 4.33.

**Solution**

At first glance, the node-voltage method looks appealing, because we may define the unknown voltage as a node voltage by choosing the lower terminal of the dependent current source as the reference node. The circuit has four essential nodes and two voltage-controlled dependent sources, so the node-voltage method requires manipulation of three node-voltage equations and two constraint equations.

Let's now turn to the mesh-current method for finding  $v_o$ . The circuit contains three meshes, and we can use the leftmost one to calculate  $v_o$ . If we

let  $i_a$  denote the leftmost mesh current, then  $v_o = 193 - 10i_a$ . The presence of the two current sources reduces the problem to manipulating a single supermesh equation and two constraint equations. Hence the mesh-current method is the more attractive technique here.



**Figure 4.33** ▲ The circuit for Example 4.7.

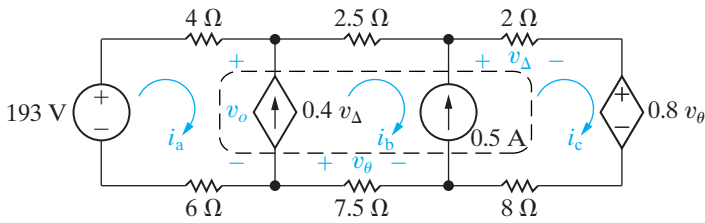


Figure 4.34 ▲ The circuit shown in Fig. 4.33 with the three mesh currents.

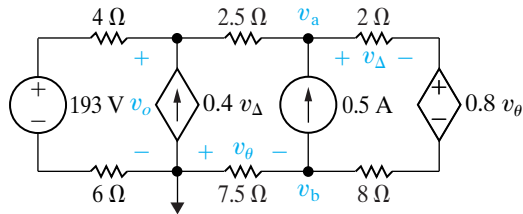


Figure 4.35 ▲ The circuit shown in Fig. 4.33 with node voltages.

To help you compare the two approaches, we summarize both methods. The mesh-current equations are based on the circuit shown in Fig. 4.34, and the node-voltage equations are based on the circuit shown in Fig. 4.35. The supermesh equation is

$$193 = 10i_a + 10i_b + 10i_c + 0.8v_\theta,$$

and the constraint equations are

$$i_b - i_a = 0.4v_\Delta = 0.8i_c;$$

$$v_\theta = -7.5i_b; \text{ and}$$

$$i_c - i_b = 0.5.$$

We use the constraint equations to write the supermesh equation in terms of  $i_a$ :

$$160 = 80i_a, \text{ or } i_a = 2 \text{ A},$$

$$v_o = 193 - 20 = 173 \text{ V}.$$

The node-voltage equations are

$$\frac{v_o - 193}{10} - 0.4v_\Delta + \frac{v_o - v_a}{2.5} = 0,$$

$$\frac{v_a - v_o}{2.5} - 0.5 + \frac{v_a - (v_b + 0.8v_\theta)}{10} = 0,$$

$$\frac{v_b}{7.5} + 0.5 + \frac{v_b + 0.8v_\theta - v_a}{10} = 0.$$

The constraint equations are

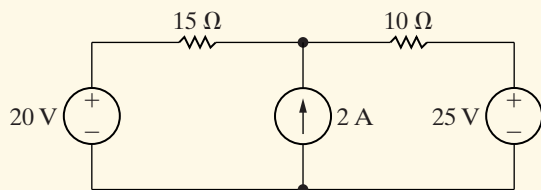
$$v_\theta = -v_b, \quad v_\Delta = \left[ \frac{v_a - (v_b + 0.8v_\theta)}{10} \right] 2.$$

We use the constraint equations to reduce the node-voltage equations to three simultaneous equations involving  $v_o$ ,  $v_a$ , and  $v_b$ . You should verify that the node-voltage approach also gives  $v_o = 173 \text{ V}$ .

## ASSESSMENT PROBLEMS

### Objective 3—Deciding between the node-voltage and mesh-current methods

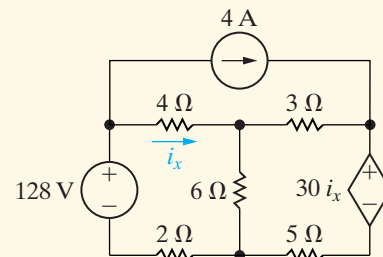
4.13 Find the power delivered by the 2 A current source in the circuit shown.



Answer: 70 W.

NOTE: Also try Chapter Problems 4.54 and 4.56.

4.14 Find the power delivered by the 4 A current source in the circuit shown.



Answer: 40 W.

## 4.9 Source Transformations

Even though the node-voltage and mesh-current methods are powerful techniques for solving circuits, we are still interested in methods that can be used to simplify circuits. Series-parallel reductions and  $\Delta$ -to-Y transformations are

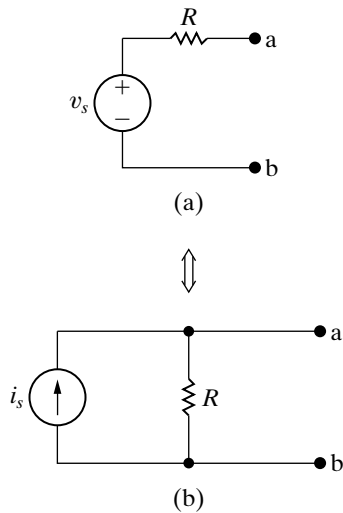


Figure 4.36 ▲ Source transformations.

already on our list of simplifying techniques. We begin expanding this list with source transformations. A **source transformation**, shown in Fig. 4.36, allows a voltage source in series with a resistor to be replaced by a current source in parallel with the same resistor or vice versa. The double-headed arrow emphasizes that a source transformation is bilateral; that is, we can start with either configuration and derive the other.

We need to find the relationship between  $v_s$  and  $i_s$  that guarantees the two configurations in Fig. 4.36 are equivalent with respect to nodes a,b. Equivalence is achieved if any resistor  $R_L$  experiences the same current flow, and thus the same voltage drop, whether connected between nodes a,b in Fig. 4.36(a) or Fig. 4.36(b).

Suppose  $R_L$  is connected between nodes a,b in Fig. 4.36(a). Using Ohm's law, the current in  $R_L$  is

$$i_L = \frac{v_s}{R + R_L}. \quad (4.52)$$

Now suppose the same resistor  $R_L$  is connected between nodes a,b in Fig. 4.36(b). Using current division, the current in  $R_L$  is

$$i_L = \frac{R}{R + R_L} i_s. \quad (4.53)$$

If the two circuits in Fig. 4.36 are equivalent, these resistor currents must be the same. Equating the right-hand sides of Eqs. 4.52 and 4.53 and simplifying,

$$i_s = \frac{v_s}{R}. \quad (4.54)$$

When Eq. 4.54 is satisfied for the circuits in Fig. 4.36, the current in  $R_L$  is the same for both circuits in the figure for all values of  $R_L$ . If the current through  $R_L$  is the same in both circuits, then the voltage drop across  $R_L$  is the same in both circuits, and the circuits are equivalent at nodes a,b.

If the polarity of  $v_s$  is reversed, the orientation of  $i_s$  must be reversed to maintain equivalence.

Example 4.8 illustrates the usefulness of making source transformations to simplify a circuit-analysis problem.

### Example 4.8 Using Source Transformations to Solve a Circuit

- For the circuit shown in Fig. 4.37, find the power associated with the 6 V source.
- State whether the 6 V source is absorbing or delivering the power calculated in (a).

#### Solution

- If we study the circuit shown in Fig. 4.37, knowing that the power associated with the 6 V source is of interest, several approaches come to mind. The circuit has four essential nodes and six essential branches where the current is unknown. Thus we can find the current in the branch containing the 6 V source by solving either three  $[6 - (4 - 1)]$  mesh-current equations or three  $[4 - 1]$  node-voltage equations. Choosing the mesh-current approach involves

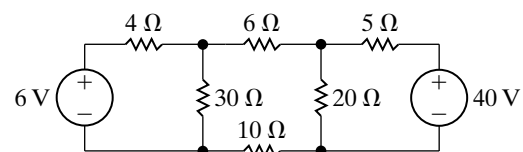


Figure 4.37 ▲ The circuit for Example 4.8.

solving for the mesh current that corresponds to the branch current in the 6 V source. Choosing the node-voltage approach involves solving for the voltage across the 30 Ω resistor, from which the branch current in the 6 V source can be calculated. But by focusing on just one branch current, we can first simplify the circuit by using source transformations.

We must reduce the circuit in a way that preserves the identity of the branch containing the 6 V source. We have no reason to preserve the identity of the branch containing the 40 V source. Beginning with

this branch, we can transform the 40 V source in series with the 5 Ω resistor into an 8 A current source in parallel with a 5 Ω resistor, as shown in Fig. 4.38(a).

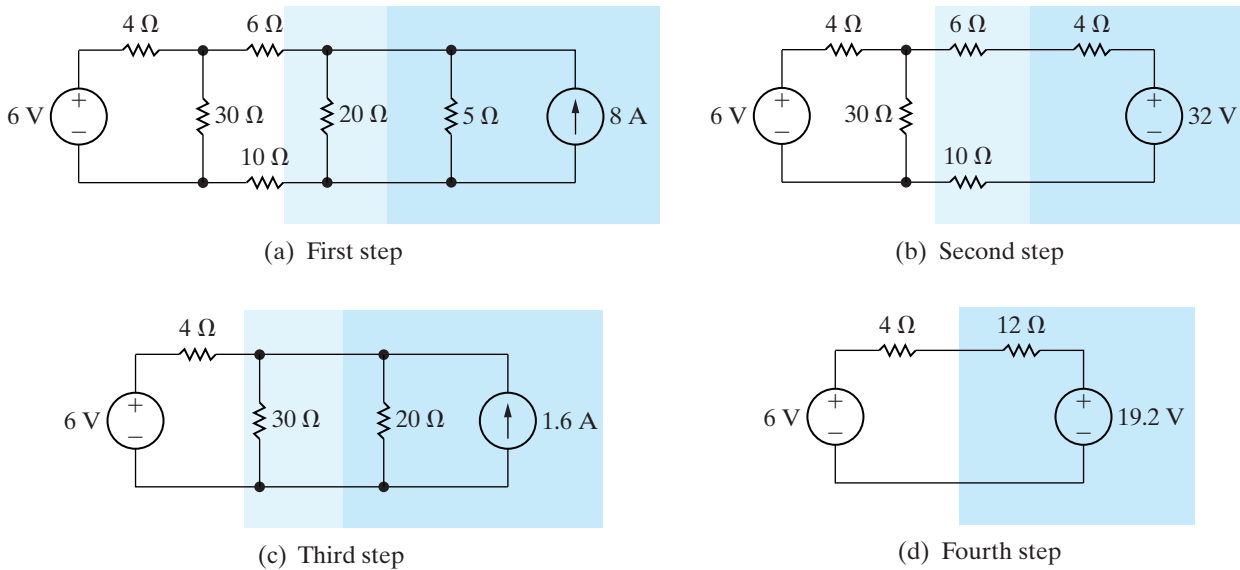


Figure 4.38 ▲ Step-by-step simplification of the circuit shown in Fig. 4.37.

Next, we can replace the parallel combination of the 20 Ω and 5 Ω resistors with a 4 Ω resistor. This 4 Ω resistor is in parallel with the 8 A source and therefore can be replaced with a 32 V source in series with a 4 Ω resistor, as shown in Fig. 4.38(b). The 32 V source is in series with 20 Ω of resistance and, hence, can be replaced by a current source of 1.6 A in parallel with 20 Ω, as shown in Fig. 4.38(c). The 20 Ω and 30 Ω parallel resistors can be reduced to a single 12 Ω resistor. The parallel combination of the 1.6 A current source

and the 12 Ω resistor transforms into a voltage source of 19.2 V in series with 12 Ω. Figure 4.38(d) shows the result of this last transformation. The current in the direction of the voltage drop across the 6 V source is  $(19.2 - 6)/16$ , or 0.825 A. Therefore the power associated with the 6 V source is

$$p_{6V} = (0.825)(6) = 4.95 \text{ W.}$$

b) The voltage source is absorbing power.

A question that arises from use of the source transformation depicted in Fig. 4.38 is, “What happens if there is a resistance  $R_p$  in parallel with the voltage source or a resistance  $R_s$  in series with the current source?” In both cases, the resistance has no effect on the equivalent circuit that predicts behavior with respect to terminals a,b. Figure 4.39 summarizes this observation.

The two circuits depicted in Fig. 4.39(a) are equivalent with respect to terminals a,b because they produce the same voltage and current in any resistor  $R_L$  inserted between nodes a,b. The same can be said for the circuits in Fig. 4.39(b). Example 4.9 illustrates an application of the equivalent circuits depicted in Fig. 4.39.

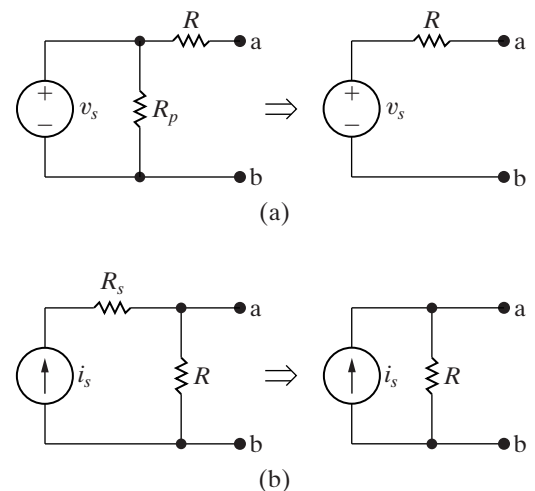
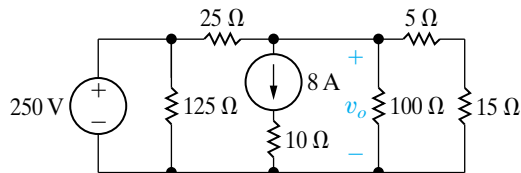


Figure 4.39 ▲ Equivalent circuits containing a resistance in parallel with a voltage source or in series with a current source.

**Example 4.9** Using Special Source Transformation Techniques

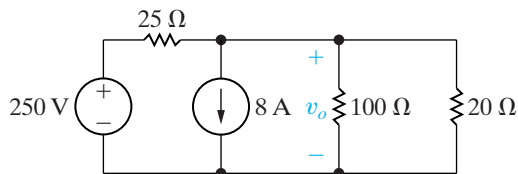
- a) Use source transformations to find the voltage  $v_o$  in the circuit shown in Fig. 4.40.
- b) Find the power developed by the 250 V voltage source.
- c) Find the power developed by the 8 A current source.



**Figure 4.40** ▲ The circuit for Example 4.9.

**Solution**

- a) We begin by removing the 125 Ω and 10 Ω resistors, because the 125 Ω resistor is connected across the 250 V voltage source and the 10 Ω resistor is connected in series with the 8 A current source. We also combine the series-connected resistors into a single resistance of 20 Ω. Figure 4.41 shows the simplified circuit.



**Figure 4.41** ▲ A simplified version of the circuit shown in Fig. 4.40.

We now use a source transformation to replace the 250 V source and 25 Ω resistor with a 10 A source in parallel with the 25 Ω resistor, as shown in Fig. 4.42. We can now simplify the circuit shown in Fig. 4.42 by using Kirchhoff's current law to combine the parallel current sources into a single source. The parallel resistors combine into a single resistor. Figure 4.43 shows the result. Hence  $v_o = 20$  V.

- b) The current supplied by the 250 V source equals the current in the 125 Ω resistor plus the current in the 25 Ω resistor. Thus

$$i_s = \frac{250}{125} + \frac{250 - 20}{25} = 11.2 \text{ A.}$$

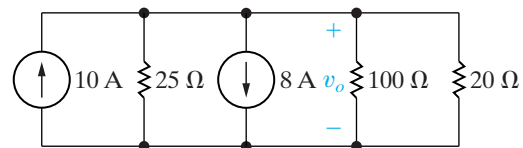
Therefore the power developed by the voltage source is

$$p_{250\text{V}}(\text{developed}) = (250)(11.2) = 2800 \text{ W.}$$

- c) To find the power developed by the 8 A current source, we first find the voltage across the source. If we let  $v_s$  represent the voltage across the source, positive at the upper terminal of the source, we obtain

$$v_s + 8(10) = v_o = 20, \quad \text{or} \quad v_s = -60 \text{ V,}$$

and the power developed by the 8 A source is 480 W. Note that the 125 Ω and 10 Ω resistors do not affect the value of  $v_o$  but do affect the power calculations.



**Figure 4.42** ▲ The circuit shown in Fig. 4.41 after a source transformation.



**Figure 4.43** ▲ The circuit shown in Fig. 4.42 after combining sources and resistors.

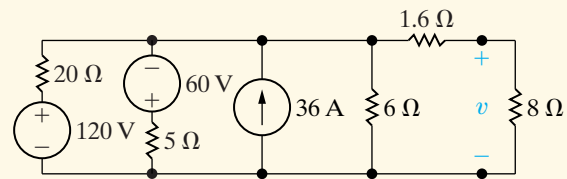
## ASSESSMENT PROBLEM

### Objective 4—Understand source transformation

- 4.15 a) Use a series of source transformations to find the voltage  $v$  in the circuit shown.  
 b) How much power does the 120 V source deliver to the circuit?

**Answer:** (a) 48 V;  
 (b) 374.4 W.

*NOTE:* Also try Chapter Problems 4.61 and 4.62.



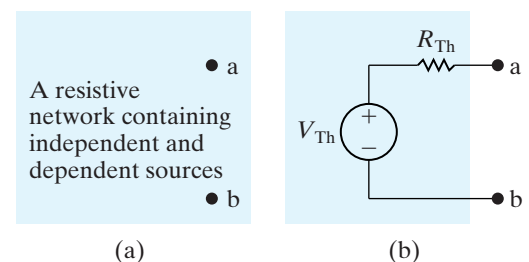
## 4.10 Thévenin and Norton Equivalents

At times in circuit analysis, we want to concentrate on what happens at a specific pair of terminals. For example, when we plug a toaster into an outlet, we are interested primarily in the voltage and current at the terminals of the toaster. We have little or no interest in the effect that connecting the toaster has on voltages or currents elsewhere in the circuit supplying the outlet. We can expand this interest in terminal behavior to a set of appliances, each requiring a different amount of power. We then are interested in how the voltage and current delivered at the outlet change as we change appliances. In other words, we want to focus on the behavior of the circuit supplying the outlet, but only at the outlet terminals.

Thévenin and Norton equivalents are circuit simplification techniques that focus on terminal behavior and thus are extremely valuable aids in analysis. Although here we discuss them as they pertain to resistive circuits, Thévenin and Norton equivalent circuits may be used to represent any circuit made up of linear elements.

We can best describe a Thévenin equivalent circuit by reference to Fig. 4.44, which represents any circuit made up of sources (both independent and dependent) and resistors. The letters a and b denote the pair of terminals of interest. Figure 4.44(b) shows the Thévenin equivalent. Thus, a **Thévenin equivalent circuit** is an independent voltage source  $V_{Th}$  in series with a resistor  $R_{Th}$ , which replaces an interconnection of sources and resistors. This series combination of  $V_{Th}$  and  $R_{Th}$  is equivalent to the original circuit in the sense that, if we connect the same load across the terminals a,b of each circuit, we get the same voltage and current at the terminals of the load. This equivalence holds for all possible values of load resistance.

To represent the original circuit by its Thévenin equivalent, we must be able to determine the Thévenin voltage  $V_{Th}$  and the Thévenin resistance  $R_{Th}$ . First, we note that if the load resistance is infinitely large, we have an open-circuit condition. The open-circuit voltage at the terminals a,b in the circuit shown in Fig. 4.44(b) is  $V_{Th}$ . By hypothesis, this must be



**Figure 4.44** ▲ (a) A general circuit. (b) The Thévenin equivalent circuit.



the same as the open-circuit voltage at the terminals a,b in the original circuit. Therefore, to calculate the Thévenin voltage  $V_{Th}$ , we simply calculate the open-circuit voltage in the original circuit.

Reducing the load resistance to zero gives us a short-circuit condition. If we place a short circuit across the terminals a,b of the Thévenin equivalent circuit, the short-circuit current directed from a to b is

$$i_{sc} = \frac{V_{Th}}{R_{Th}}. \quad (4.55)$$

By hypothesis, this short-circuit current must be identical to the short-circuit current that exists in a short circuit placed across the terminals a,b of the original network. From Eq. 4.55,

$$R_{Th} = \frac{V_{Th}}{i_{sc}}. \quad (4.56)$$

Thus the Thévenin resistance is the ratio of the open-circuit voltage to the short-circuit current.

### Finding a Thévenin Equivalent

To find the Thévenin equivalent of the circuit shown in Fig. 4.45, we first calculate the open-circuit voltage of  $v_{ab}$ . Note that when the terminals a,b are open, there is no current in the  $4\ \Omega$  resistor. Therefore the open-circuit voltage  $v_{ab}$  is identical to the voltage across the  $3\text{ A}$  current source, labeled  $v_1$ . We find the voltage by solving a single node-voltage equation. Choosing the lower node as the reference node, we get

$$\frac{v_1 - 25}{5} + \frac{v_1}{20} - 3 = 0. \quad (4.57)$$

Solving for  $v_1$  yields

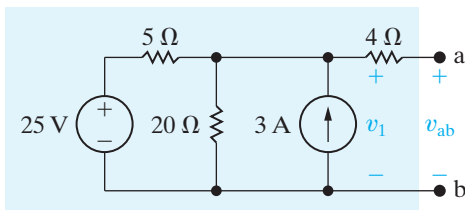
$$v_1 = 32\text{ V}. \quad (4.58)$$

Hence the Thévenin voltage for the circuit is  $32\text{ V}$ .

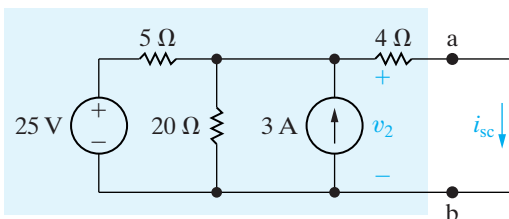
The next step is to place a short circuit across the terminals and calculate the resulting short-circuit current. Figure 4.46 shows the circuit with the short in place. Note that the short-circuit current is in the direction of the open-circuit voltage drop across the terminals a,b. If the short-circuit current is in the direction of the open-circuit voltage rise across the terminals, a minus sign must be inserted in Eq. 4.56.

The short-circuit current ( $i_{sc}$ ) is found easily once  $v_2$  is known. Therefore the problem reduces to finding  $v_2$  with the short in place. Again, if we use the lower node as the reference node, the equation for  $v_2$  becomes

$$\frac{v_2 - 25}{5} + \frac{v_2}{20} - 3 + \frac{v_2}{4} = 0. \quad (4.59)$$



**Figure 4.45** ▲ A circuit used to illustrate a Thévenin equivalent.



**Figure 4.46** ▲ The circuit shown in Fig. 4.45 with terminals a and b short-circuited.

Solving Eq. 4.59 for  $v_2$  gives

$$v_2 = 16 \text{ V.} \quad (4.60)$$

Hence, the short-circuit current is

$$i_{sc} = \frac{16}{4} = 4 \text{ A.} \quad (4.61)$$

We now find the Thévenin resistance by substituting the numerical results from Eqs. 4.58 and 4.61 into Eq. 4.56:

$$R_{Th} = \frac{V_{Th}}{i_{sc}} = \frac{32}{4} = 8 \Omega. \quad (4.62)$$

Figure 4.47 shows the Thévenin equivalent for the circuit shown in Fig. 4.45.

You should verify that, if a  $24 \Omega$  resistor is connected across the terminals a,b in Fig. 4.45, the voltage across the resistor will be  $24 \text{ V}$  and the current in the resistor will be  $1 \text{ A}$ , as would be the case with the Thévenin circuit in Fig. 4.47. This same equivalence between the circuit in Figs. 4.45 and 4.47 holds for any resistor value connected between nodes a,b.

## The Norton Equivalent

A **Norton equivalent circuit** consists of an independent current source in parallel with the Norton equivalent resistance. We can derive it from a Thévenin equivalent circuit simply by making a source transformation. Thus the Norton current equals the short-circuit current at the terminals of interest, and the Norton resistance is identical to the Thévenin resistance.

## Using Source Transformations

Sometimes we can make effective use of source transformations to derive a Thévenin or Norton equivalent circuit. For example, we can derive the Thévenin and Norton equivalents of the circuit shown in Fig. 4.45 by making the series of source transformations shown in Fig. 4.48. This technique is most useful when the network contains only independent sources. The presence of dependent sources requires retaining the identity of the controlling voltages and/or currents, and this constraint usually prohibits continued reduction of the circuit by source transformations. We discuss the problem of finding the Thévenin equivalent when a circuit contains dependent sources in Example 4.10.

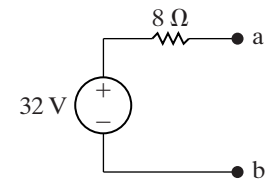


Figure 4.47 ▲ The Thévenin equivalent of the circuit shown in Fig. 4.45.

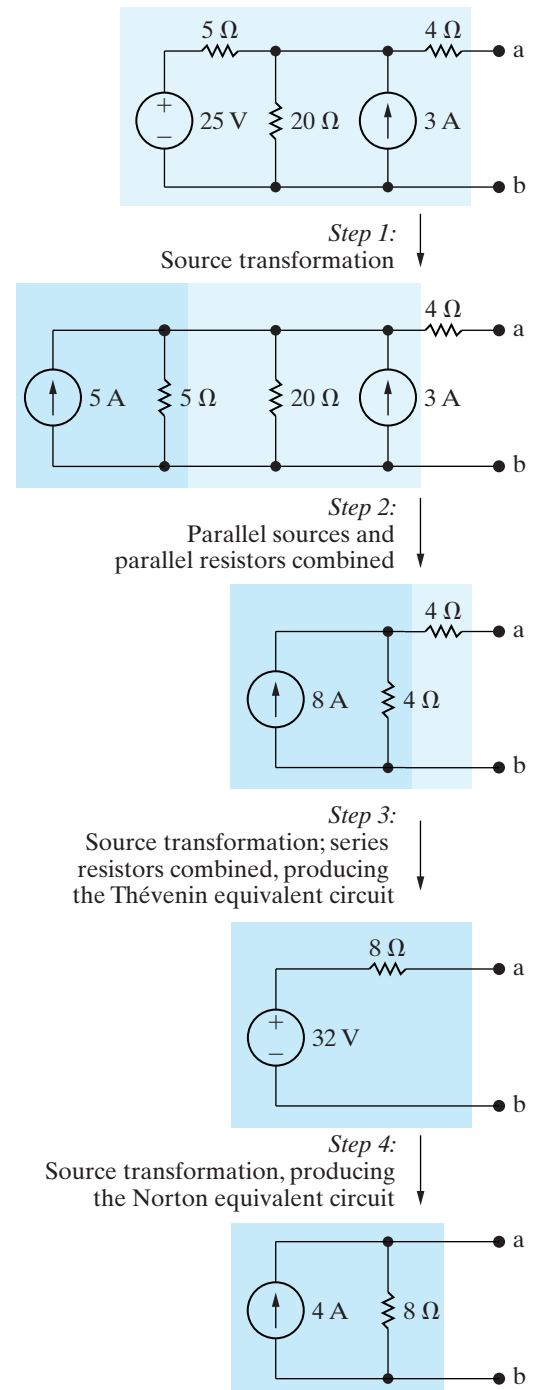
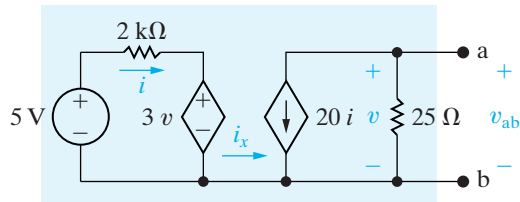


Figure 4.48 ▲ Step-by-step derivation of the Thévenin and Norton equivalents of the circuit shown in Fig. 4.45.

**Example 4.10** Finding the Thévenin Equivalent of a Circuit with a Dependent Source

Find the Thévenin equivalent for the circuit containing dependent sources shown in Fig. 4.49.



**Figure 4.49** ▲ A circuit used to illustrate a Thévenin equivalent when the circuit contains dependent sources.

**Solution**

The first step in analyzing the circuit in Fig. 4.49 is to recognize that the current labeled  $i_x$  must be zero. (Note the absence of a return path for  $i_x$  to enter the left-hand portion of the circuit.) The open-circuit, or Thévenin, voltage will be the voltage across the  $25\ \Omega$  resistor. With  $i_x = 0$ ,

$$V_{\text{Th}} = v_{\text{ab}} = (-20i)(25) = -500i.$$

The current  $i$  is

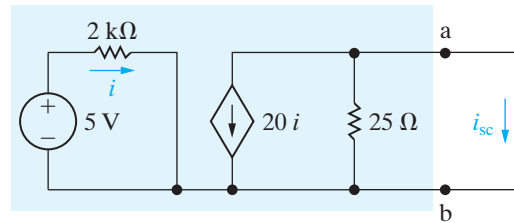
$$i = \frac{5 - 3v}{2000} = \frac{5 - 3V_{\text{Th}}}{2000}.$$

In writing the equation for  $i$ , we recognize that the Thévenin voltage is identical to the control voltage. When we combine these two equations, we obtain

$$V_{\text{Th}} = -5\ \text{V}.$$

To calculate the short-circuit current, we place a short circuit across a,b. When the terminals a,b are shorted together, the control voltage  $v$  is reduced to zero. Therefore, with the short in place, the circuit shown in Fig. 4.49 becomes the one shown in Fig. 4.50. With the short circuit shunting the  $25\ \Omega$  resistor, all the current from the dependent current source appears in the short, so

$$i_{\text{sc}} = -20i.$$



**Figure 4.50** ▲ The circuit shown in Fig. 4.49 with terminals a and b short-circuited.

As the voltage controlling the dependent voltage source has been reduced to zero, the current controlling the dependent current source is

$$i = \frac{5}{2000} = 2.5\ \text{mA}.$$

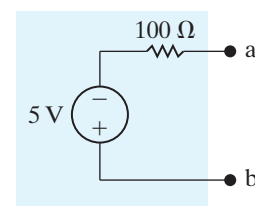
Combining these two equations yields a short-circuit current of

$$i_{\text{sc}} = -20(2.5) = -50\ \text{mA}.$$

From  $i_{\text{sc}}$  and  $V_{\text{Th}}$  we get

$$R_{\text{Th}} = \frac{V_{\text{Th}}}{i_{\text{sc}}} = \frac{-5}{-50} \times 10^3 = 100\ \Omega.$$

Figure 4.51 illustrates the Thévenin equivalent for the circuit shown in Fig. 4.49. Note that the reference polarity marks on the Thévenin voltage source in Fig. 4.51 agree with the preceding equation for  $V_{\text{Th}}$ .

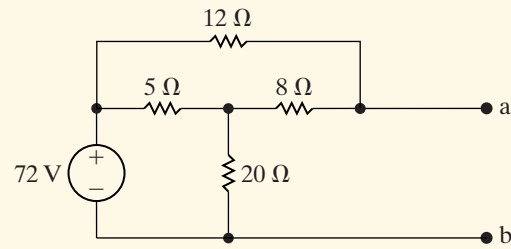


**Figure 4.51** ▲ The Thévenin equivalent for the circuit shown in Fig. 4.49.

## ASSESSMENT PROBLEMS

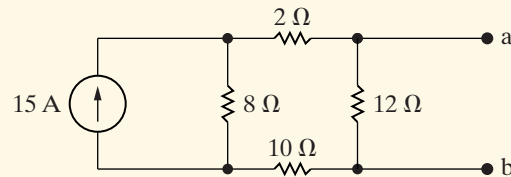
### Objective 5—Understand Thévenin and Norton equivalents

**4.16** Find the Thévenin equivalent circuit with respect to the terminals a,b for the circuit shown.



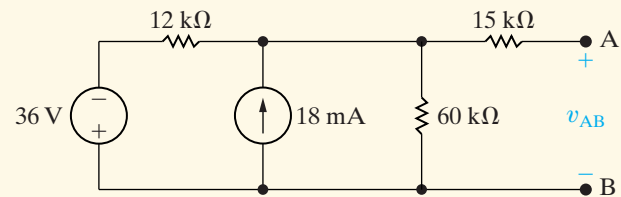
**Answer:**  $V_{ab} = V_{Th} = 64.8 \text{ V}$ ,  $R_{Th} = 6 \Omega$ .

**4.17** Find the Norton equivalent circuit with respect to the terminals a,b for the circuit shown.



**Answer:**  $I_N = 6 \text{ A}$  (directed toward a),  $R_N = 7.5 \Omega$ .

**4.18** A voltmeter with an internal resistance of  $100 \text{ k}\Omega$  is used to measure the voltage  $v_{AB}$  in the circuit shown. What is the voltmeter reading?



**Answer:** 120 V.

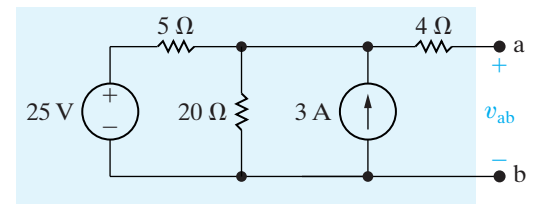
*NOTE:* Also try Chapter Problems 4.64, 4.68, and 4.72.

## 4.11 More on Deriving a Thévenin Equivalent

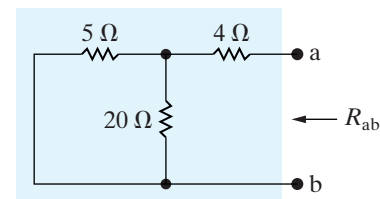
The technique for determining  $R_{Th}$  that we discussed and illustrated in Section 4.10 is not always the easiest method available. Two other methods generally are simpler to use. The first is useful if the network contains only independent sources. To calculate  $R_{Th}$  for such a network, we first deactivate all independent sources and then calculate the resistance seen looking into the network at the designated terminal pair. A voltage source is deactivated by replacing it with a short circuit. A current source is deactivated by replacing it with an open circuit. For example, consider the circuit shown in Fig. 4.52. Deactivating the independent sources simplifies the circuit to the one shown in Fig. 4.53. The resistance seen looking into the terminals a,b is denoted  $R_{ab}$ , which consists of the  $4 \Omega$  resistor in series with the parallel combinations of the  $5 \Omega$  and  $20 \Omega$  resistors. Thus,

$$R_{ab} = R_{Th} = 4 + \frac{5 \times 20}{25} = 8 \Omega. \quad (4.63)$$

Note that the derivation of  $R_{Th}$  with Eq. 4.63 is much simpler than the same derivation with Eqs. 4.57–4.62.



**Figure 4.52** ▲ A circuit used to illustrate a Thévenin equivalent.



**Figure 4.53** ▲ The circuit shown in Fig. 4.52 after deactivation of the independent sources.

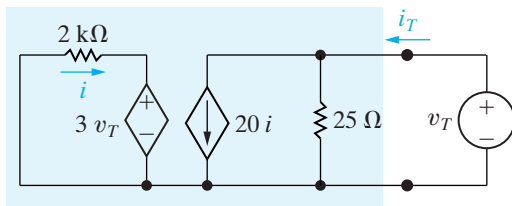
If the circuit or network contains dependent sources, an alternative procedure for finding the Thévenin resistance  $R_{Th}$  is as follows. We first deactivate all independent sources, and we then apply either a test voltage source or a test current source to the Thévenin terminals a,b. The Thévenin resistance equals the ratio of the voltage across the test source to the current delivered by the test source. Example 4.11 illustrates this alternative procedure for finding  $R_{Th}$ , using the same circuit as Example 4.10.

**Example 4.11** Finding the Thévenin Equivalent Using a Test Source

Find the Thévenin resistance  $R_{Th}$  for the circuit in Fig. 4.49, using the alternative method described.

**Solution**

We first deactivate the independent voltage source from the circuit and then excite the circuit from the terminals a,b with either a test voltage source or a test current source. If we apply a test voltage source, we will know the voltage of the dependent voltage source and hence the controlling current  $i$ . Therefore we opt for the test voltage source. Figure 4.54 shows the circuit for computing the Thévenin resistance.



**Figure 4.54** ▲ An alternative method for computing the Thévenin resistance.

The externally applied test voltage source is denoted  $v_T$ , and the current that it delivers to the circuit is labeled  $i_T$ . To find the Thévenin resistance, we simply solve the circuit shown in Fig. 4.54 for the ratio of the voltage to the current at the test source; that is,  $R_{Th} = v_T/i_T$ . From Fig. 4.54,

$$i_T = \frac{v_T}{25} + 20i, \tag{4.64}$$

$$i = \frac{-3v_T}{2} \text{ mA}. \tag{4.65}$$

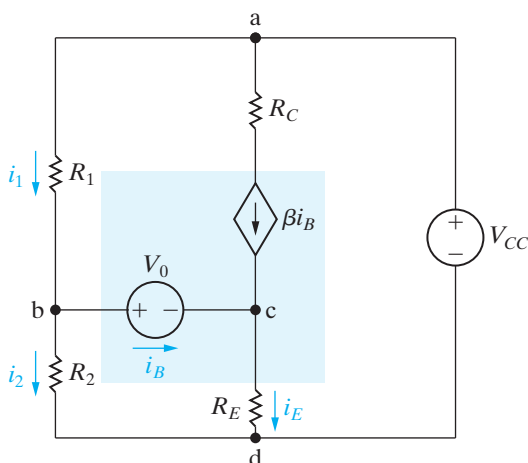
We then substitute Eq. 4.65 into Eq. 4.64 and solve the resulting equation for the ratio  $v_T/i_T$ :

$$i_T = \frac{v_T}{25} - \frac{60v_T}{2000}, \tag{4.66}$$

$$\frac{i_T}{v_T} = \frac{1}{25} - \frac{6}{200} = \frac{50}{5000} = \frac{1}{100}. \tag{4.67}$$

From Eqs. 4.66 and 4.67,

$$R_{Th} = \frac{v_T}{i_T} = 100 \Omega. \tag{4.68}$$



**Figure 4.55** ▲ The application of a Thévenin equivalent in circuit analysis.

In general, these computations are easier than those involved in computing the short-circuit current. Moreover, in a network containing only resistors and dependent sources, you must use the alternative method, because the ratio of the Thévenin voltage to the short-circuit current is indeterminate. That is, it is the ratio 0/0.

**Using the Thévenin Equivalent in the Amplifier Circuit**

At times we can use a Thévenin equivalent to reduce one portion of a circuit to greatly simplify analysis of the larger network. Let's return to the circuit first introduced in Section 2.5 and subsequently analyzed in Sections 4.4 and 4.7. To aid our discussion, we redrew the circuit and identified the branch currents of interest, as shown in Fig. 4.55.

As our previous analysis has shown,  $i_B$  is the key to finding the other branch currents. We redraw the circuit as shown in Fig. 4.56 to prepare to replace the subcircuit to the left of  $V_0$  with its Thévenin equivalent. You

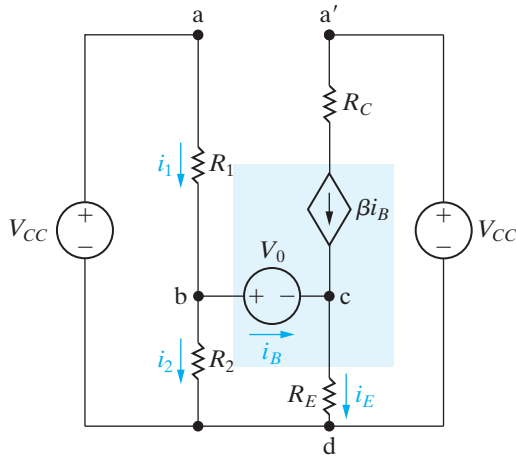


Figure 4.56 ▲ A modified version of the circuit shown in Fig. 4.55.

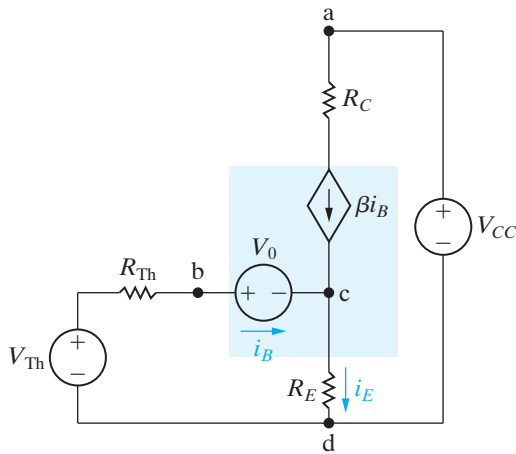


Figure 4.57 ▲ The circuit shown in Fig. 4.56 modified by a Thévenin equivalent.

should be able to determine that this modification has no effect on the branch currents  $i_1$ ,  $i_2$ ,  $i_B$ , and  $i_E$ .

Now we replace the circuit made up of  $V_{CC}$ ,  $R_1$ , and  $R_2$  with a Thévenin equivalent, with respect to the terminals b,d. The Thévenin voltage and resistance are

$$V_{Th} = \frac{V_{CC}R_2}{R_1 + R_2}, \quad (4.69)$$

$$R_{Th} = \frac{R_1R_2}{R_1 + R_2}. \quad (4.70)$$

With the Thévenin equivalent, the circuit in Fig. 4.56 becomes the one shown in Fig. 4.57.

We now derive an equation for  $i_B$  simply by summing the voltages around the left mesh. In writing this mesh equation, we recognize that  $i_E = (1 + \beta)i_B$ . Thus,

$$V_{Th} = R_{Th}i_B + V_0 + R_E(1 + \beta)i_B, \quad (4.71)$$

from which

$$i_B = \frac{V_{Th} - V_0}{R_{Th} + (1 + \beta)R_E}. \quad (4.72)$$

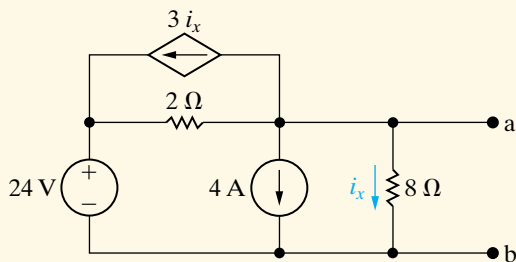
When we substitute Eqs. 4.69 and 4.70 into Eq. 4.72, we get the same expression obtained in Eq. 2.25. Note that when we have incorporated the Thévenin equivalent into the original circuit, we can obtain the solution for  $i_B$  by writing a single equation.

## ASSESSMENT PROBLEMS

### Objective 5—Understand Thévenin and Norton equivalents

4.19 Find the Thévenin equivalent circuit with respect to the terminals a,b for the circuit shown.

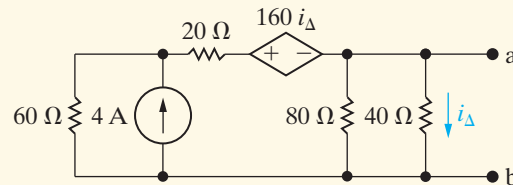
Answer:  $V_{Th} = v_{ab} = 8 \text{ V}$ ,  $R_{Th} = 1 \Omega$ .



NOTE: Also try Chapter Problems 4.74 and 4.79.

4.20 Find the Thévenin equivalent circuit with respect to the terminals a,b for the circuit shown. (Hint: Define the voltage at the left-most node as  $v$ , and write two nodal equations with  $V_{Th}$  as the right node voltage.)

Answer:  $V_{Th} = v_{ab} = 30 \text{ V}$ ,  $R_{Th} = 10 \Omega$ .



## 4.12 Maximum Power Transfer

Circuit analysis plays an important role in the analysis of systems designed to transfer power from a source to a load. We discuss power transfer in terms of two basic types of systems. The first emphasizes the efficiency of the power transfer. Power utility systems are a good example of this type because they are concerned with the generation, transmission, and distribution of large quantities of electric power. If a power utility system is inefficient, a large percentage of the power generated is lost in the transmission and distribution processes, and thus wasted.

The second basic type of system emphasizes the amount of power transferred. Communication and instrumentation systems are good examples because in the transmission of information, or data, via electric signals, the power available at the transmitter or detector is limited. Thus, transmitting as much of this power as possible to the receiver, or load, is desirable. In such applications the amount of power being transferred is small, so the efficiency of transfer is not a primary concern. We now consider maximum power transfer in systems that can be modeled by a purely resistive circuit.

Maximum power transfer can best be described with the aid of the circuit shown in Fig. 4.58. We assume a resistive network containing independent and dependent sources and a designated pair of terminals, a,b, to which a load,  $R_L$ , is to be connected. The problem is to determine the value of  $R_L$  that permits maximum power delivery to  $R_L$ . The first step in this process is to recognize that a resistive network can always be replaced by its Thévenin equivalent. Therefore, we redraw the circuit shown in Fig. 4.58 as the one shown in Fig. 4.59. Replacing the original network by its Thévenin equivalent greatly simplifies the task of finding  $R_L$ . Derivation of  $R_L$  requires expressing the power dissipated in  $R_L$  as a function of the three circuit parameters  $V_{Th}$ ,  $R_{Th}$ , and  $R_L$ . Thus

$$p = i^2 R_L = \left( \frac{V_{Th}}{R_{Th} + R_L} \right)^2 R_L. \quad (4.73)$$

Next, we recognize that for a given circuit,  $V_{Th}$  and  $R_{Th}$  will be fixed. Therefore the power dissipated is a function of the single variable  $R_L$ . To find the value of  $R_L$  that maximizes the power, we use elementary calculus. We begin by writing an equation for the derivative of  $p$  with respect to  $R_L$ :

$$\frac{dp}{dR_L} = V_{Th}^2 \left[ \frac{(R_{Th} + R_L)^2 - R_L \cdot 2(R_{Th} + R_L)}{(R_{Th} + R_L)^4} \right]. \quad (4.74)$$

The derivative is zero and  $p$  is maximized when

$$(R_{Th} + R_L)^2 = 2R_L(R_{Th} + R_L). \quad (4.75)$$

Solving Eq. 4.75 yields

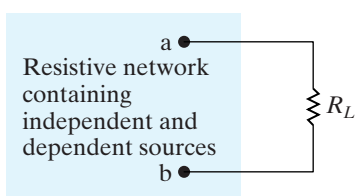
**Condition for maximum power transfer** ►

$$R_L = R_{Th}. \quad (4.76)$$

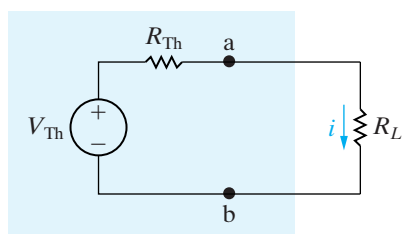
Thus maximum power transfer occurs when the load resistance  $R_L$  equals the Thévenin resistance  $R_{Th}$ . To find the maximum power delivered to  $R_L$ , we simply substitute Eq. 4.76 into Eq. 4.73:

$$p_{\max} = \frac{V_{Th}^2 R_L}{(2R_L)^2} = \frac{V_{Th}^2}{4R_L}. \quad (4.77)$$

The analysis of a circuit when the load resistor is adjusted for maximum power transfer is illustrated in Example 4.12.



**Figure 4.58** ▲ A circuit describing maximum power transfer.

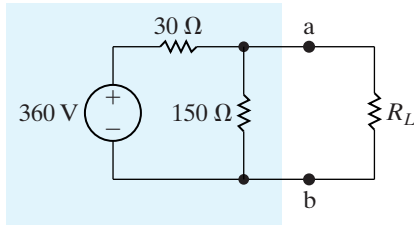


**Figure 4.59** ▲ A circuit used to determine the value of  $R_L$  for maximum power transfer.



**Example 4.12** Calculating the Condition for Maximum Power Transfer

- a) For the circuit shown in Fig. 4.60, find the value of  $R_L$  that results in maximum power being transferred to  $R_L$ .



**Figure 4.60** ▲ The circuit for Example 4.12.

- b) Calculate the maximum power that can be delivered to  $R_L$ .  
 c) When  $R_L$  is adjusted for maximum power transfer, what percentage of the power delivered by the 360 V source reaches  $R_L$ ?

**Solution**

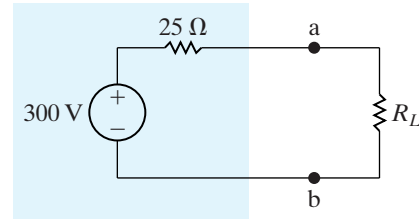
- a) The Thévenin voltage for the circuit to the left of the terminals a,b is

$$V_{\text{Th}} = \frac{150}{180}(360) = 300 \text{ V.}$$

The Thévenin resistance is

$$R_{\text{Th}} = \frac{(150)(30)}{180} = 25 \Omega.$$

Replacing the circuit to the left of the terminals a,b with its Thévenin equivalent gives us the circuit shown in Fig. 4.61, which indicates that  $R_L$  must equal  $25 \Omega$  for maximum power transfer.



**Figure 4.61** ▲ Reduction of the circuit shown in Fig. 4.60 by means of a Thévenin equivalent.

- b) The maximum power that can be delivered to  $R_L$  is

$$p_{\text{max}} = \left(\frac{300}{50}\right)^2 (25) = 900 \text{ W.}$$

- c) When  $R_L$  equals  $25 \Omega$ , the voltage  $v_{ab}$  is

$$v_{ab} = \left(\frac{300}{50}\right)(25) = 150 \text{ V.}$$

From Fig. 4.60, when  $v_{ab}$  equals 150 V, the current in the voltage source in the direction of the voltage rise across the source is

$$i_s = \frac{360 - 150}{30} = \frac{210}{30} = 7 \text{ A.}$$

Therefore, the source is delivering 2520 W to the circuit, or

$$p_s = -i_s(360) = -2520 \text{ W.}$$

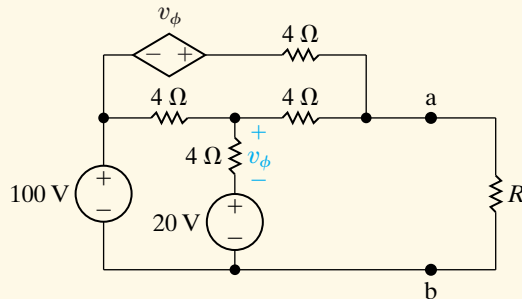
The percentage of the source power delivered to the load is

$$\frac{900}{2520} \times 100 = 35.71\%.$$

## ASSESSMENT PROBLEMS

### Objective 6—Know the condition for and calculate maximum power transfer to resistive load

- 4.21 a) Find the value of  $R$  that enables the circuit shown to deliver maximum power to the terminals a,b.  
b) Find the maximum power delivered to  $R$ .



- Answer:** (a)  $3 \Omega$ ;  
(b)  $1.2 \text{ kW}$ .

*NOTE:* Also try Chapter Problems 4.88 and 4.90.

- 4.22 Assume that the circuit in Assessment Problem 4.21 is delivering maximum power to the load resistor  $R$ .
- How much power is the  $100 \text{ V}$  source delivering to the network?
  - Repeat (a) for the dependent voltage source.
  - What percentage of the total power generated by these two sources is delivered to the load resistor  $R$ ?

- Answer:** (a)  $3000 \text{ W}$ ;  
(b)  $800 \text{ W}$ ;  
(c)  $31.58\%$ .

## 4.13 Superposition

A linear system obeys the principle of **superposition**, which states that whenever a linear system is excited, or driven, by more than one independent source of energy, the total response is the sum of the individual responses. An individual response is the result of an independent source acting alone. Because we are dealing with circuits made up of interconnected linear-circuit elements, we can apply the principle of superposition directly to the analysis of such circuits when they are driven by more than one independent energy source. At present, we restrict the discussion to simple resistive networks; however, the principle is applicable to any linear system.

Superposition is applied in both the analysis and the design of circuits. In analyzing a complex circuit with multiple independent voltage and current sources, there are often fewer, simpler equations to solve when the effects of the independent sources are considered one at a time. Applying superposition can thus simplify circuit analysis. Be aware, though, that sometimes applying superposition actually complicates the analysis, producing more equations to solve than with an alternative method. Superposition is required only if the independent sources in a circuit are fundamentally different. In these early chapters, all independent sources are dc sources, so superposition is not required. We introduce superposition here in anticipation of later chapters in which circuits will require it.

Superposition is applied in design to synthesize a desired circuit response that could not be achieved in a circuit with a single source. If the desired circuit response can be written as a sum of two or more terms, the response can be realized by including one independent source for each term of the response. This approach to the design of circuits with complex responses allows a designer to consider several simple designs instead of one complex design.

We demonstrate the superposition principle by using it to find the branch currents in the circuit shown in Fig. 4.62. We begin by finding the branch currents resulting from the 120 V voltage source. We denote those currents with a prime. Replacing the ideal current source with an open circuit deactivates it; Fig. 4.63 shows this. The branch currents in this circuit are the result of only the voltage source.

We can easily find the branch currents in the circuit in Fig. 4.63 once we know the node voltage across the 3  $\Omega$  resistor. Denoting this voltage  $v_1$ , we write

$$\frac{v_1 - 120}{6} + \frac{v_1}{3} + \frac{v_1}{2 + 4} = 0, \quad (4.78)$$

from which

$$v_1 = 30 \text{ V}. \quad (4.79)$$

Now we can write the expressions for the branch currents  $i'_1 - i'_4$  directly:

$$i'_1 = \frac{120 - 30}{6} = 15 \text{ A}, \quad (4.80)$$

$$i'_2 = \frac{30}{3} = 10 \text{ A}, \quad (4.81)$$

$$i'_3 = i'_4 = \frac{30}{6} = 5 \text{ A}. \quad (4.82)$$

To find the component of the branch currents resulting from the current source, we deactivate the ideal voltage source and solve the circuit shown in Fig. 4.64. The double-prime notation for the currents indicates they are the components of the total current resulting from the ideal current source.

We determine the branch currents in the circuit shown in Fig. 4.64 by first solving for the node voltages across the 3 and 4  $\Omega$  resistors, respectively. Figure 4.65 shows the two node voltages. The two node-voltage equations that describe the circuit are

$$\frac{v_3}{3} + \frac{v_3}{6} + \frac{v_3 - v_4}{2} = 0, \quad (4.83)$$

$$\frac{v_4 - v_3}{2} + \frac{v_4}{4} + 12 = 0. \quad (4.84)$$

Solving Eqs. 4.83 and 4.84 for  $v_3$  and  $v_4$ , we get

$$v_3 = -12 \text{ V}, \quad (4.85)$$

$$v_4 = -24 \text{ V}. \quad (4.86)$$

Now we can write the branch currents  $i''_1$  through  $i''_4$  directly in terms of the node voltages  $v_3$  and  $v_4$ :

$$i''_1 = \frac{-v_3}{6} = \frac{12}{6} = 2 \text{ A}, \quad (4.87)$$

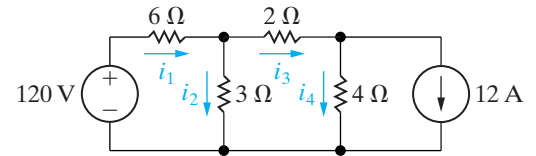


Figure 4.62 ▲ A circuit used to illustrate superposition.

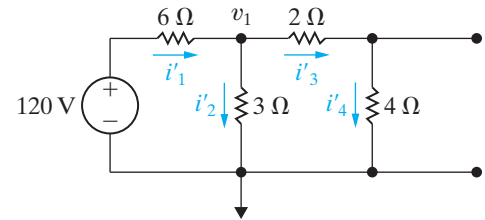


Figure 4.63 ▲ The circuit shown in Fig. 4.62 with the current source deactivated.

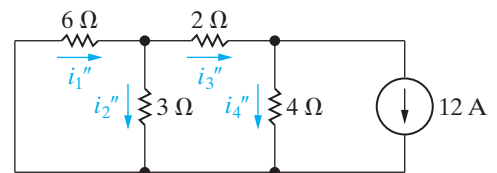


Figure 4.64 ▲ The circuit shown in Fig. 4.62 with the voltage source deactivated.

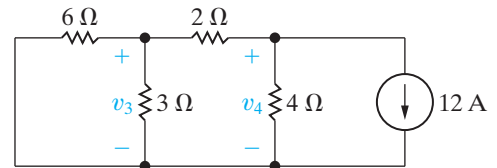


Figure 4.65 ▲ The circuit shown in Fig. 4.64 showing the node voltages  $v_3$  and  $v_4$ .

$$i_2'' = \frac{v_3}{3} = \frac{-12}{3} = -4 \text{ A}, \quad (4.88)$$

$$i_3'' = \frac{v_3 - v_4}{2} = \frac{-12 + 24}{2} = 6 \text{ A}, \quad (4.89)$$

$$i_4'' = \frac{v_4}{4} = \frac{-24}{4} = -6 \text{ A}. \quad (4.90)$$

To find the branch currents in the original circuit, that is, the currents  $i_1$ ,  $i_2$ ,  $i_3$ , and  $i_4$  in Fig. 4.62, we simply add the currents given by Eqs. 4.87–4.90 to the currents given by Eqs. 4.80–4.82:

$$i_1 = i_1' + i_1'' = 15 + 2 = 17 \text{ A}, \quad (4.91)$$

$$i_2 = i_2' + i_2'' = 10 - 4 = 6 \text{ A}, \quad (4.92)$$

$$i_3 = i_3' + i_3'' = 5 + 6 = 11 \text{ A}, \quad (4.93)$$

$$i_4 = i_4' + i_4'' = 5 - 6 = -1 \text{ A}. \quad (4.94)$$

You should verify that the currents given by Eqs. 4.91–4.94 are the correct values for the branch currents in the circuit shown in Fig. 4.62.

When applying superposition to linear circuits containing both independent and dependent sources, you must recognize that the dependent sources are never deactivated. Example 4.13 illustrates the application of superposition when a circuit contains both dependent and independent sources.

### Example 4.13 Using Superposition to Solve a Circuit

Use the principle of superposition to find  $v_o$  in the circuit shown in Fig. 4.66.

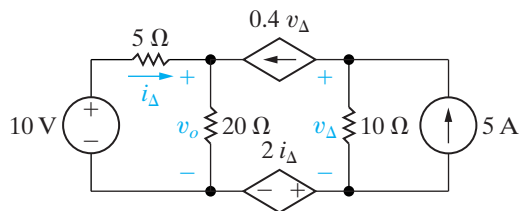


Figure 4.66 ▲ The circuit for Example 4.13.

#### Solution

We begin by finding the component of  $v_o$  resulting from the 10 V source. Figure 4.67 shows the circuit. With the 5 A source deactivated,  $v_\Delta'$  must equal

$(-0.4v_\Delta')(10)$ . Hence,  $v_\Delta'$  must be zero, the branch containing the two dependent sources is open, and

$$v_o' = \frac{20}{25}(10) = 8 \text{ V}.$$

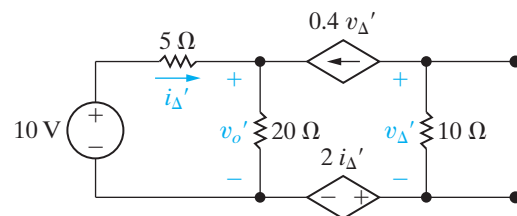


Figure 4.67 ▲ The circuit shown in Fig. 4.66 with the 5 A source deactivated.

When the 10 V source is deactivated, the circuit reduces to the one shown in Fig. 4.68. We have added a reference node and the node designations a, b, and c to aid the discussion. Summing the currents away from node a yields

$$\frac{v_o''}{20} + \frac{v_o''}{5} - 0.4v_\Delta'' = 0, \quad \text{or} \quad 5v_o'' - 8v_\Delta'' = 0.$$

Summing the currents away from node b gives

$$0.4v_\Delta'' + \frac{v_b - 2i_\Delta''}{10} - 5 = 0, \quad \text{or}$$

$$4v_\Delta'' + v_b - 2i_\Delta'' = 50.$$

We now use

$$v_b = 2i_\Delta'' + v_\Delta''$$

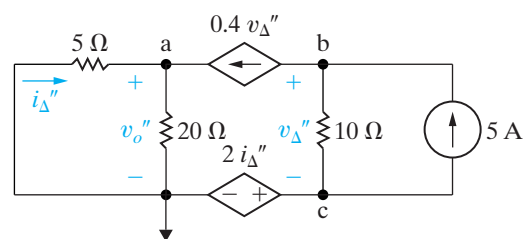
to find the value for  $v_\Delta''$ . Thus,

$$5v_\Delta'' = 50, \quad \text{or} \quad v_\Delta'' = 10 \text{ V.}$$

From the node a equation,

$$5v_o'' = 80, \quad \text{or} \quad v_o'' = 16 \text{ V.}$$

The value of  $v_o$  is the sum of  $v_o'$  and  $v_o''$ , or 24 V.



**Figure 4.68** ▲ The circuit shown in Fig. 4.66 with the 10 V source deactivated.

*NOTE:* Assess your understanding of this material by trying Chapter Problems 4.93 and 4.98.

## Practical Perspective

### Circuits with Realistic Resistors

It is not possible to fabricate identical electrical components. For example, resistors produced from the same manufacturing process can vary in value by as much as 20%. Therefore, in creating an electrical system the designer must consider the impact that component variation will have on the performance of the system. One way to evaluate this impact is by performing sensitivity analysis. Sensitivity analysis permits the designer to calculate the impact of variations in the component values on the output of the system. We will see how this information enables a designer to specify an acceptable component value tolerance for each of the system's components.

Consider the circuit shown in Fig. 4.69. To illustrate sensitivity analysis, we will investigate the sensitivity of the node voltages  $v_1$  and  $v_2$  to changes in the resistor  $R_1$ . Using nodal analysis we can derive the expressions for  $v_1$  and  $v_2$  as functions of the circuit resistors and source currents. The results are given in Eqs. 4.95 and 4.96:

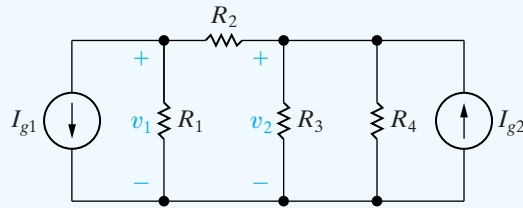
$$v_1 = \frac{R_1\{R_3R_4I_{g2} - [R_2(R_3 + R_4) + R_3R_4]I_{g1}\}}{(R_1 + R_2)(R_3 + R_4) + R_3R_4}, \quad (4.95)$$

$$v_2 = \frac{R_3R_4[(R_1 + R_2)I_{g2} - R_1I_{g1}]}{(R_1 + R_2)(R_3 + R_4) + R_3R_4}. \quad (4.96)$$

The sensitivity of  $v_1$  with respect to  $R_1$  is found by differentiating Eq. 4.95 with respect to  $R_1$ , and similarly the sensitivity of  $v_2$  with respect to  $R_1$  is found by differentiating Eq. 4.96 with respect to  $R_1$ . We get

$$\frac{dv_1}{dR_1} = \frac{[R_3R_4 + R_2(R_3 + R_4)]\{R_3R_4I_{g2} - [R_3R_4 + R_2(R_3 + R_4)]I_{g1}\}}{[(R_1 + R_2)(R_3 + R_4) + R_3R_4]^2}, \quad (4.97)$$

$$\frac{dv_2}{dR_1} = \frac{R_3 R_4 \{ R_3 R_4 I_{g2} - [R_2(R_3 + R_4) + R_3 R_4] I_{g1} \}}{[(R_1 + R_2)(R_3 + R_4) + R_3 R_4]^2}. \quad (4.98)$$



**Figure 4.69** ▲ Circuit used to introduce sensitivity analysis.

We now consider an example with actual component values to illustrate the use of Eqs. 4.97 and 4.98.

### EXAMPLE

Assume the nominal values of the components in the circuit in Fig. 4.69 are:  $R_1 = 25 \Omega$ ;  $R_2 = 5 \Omega$ ;  $R_3 = 50 \Omega$ ;  $R_4 = 75 \Omega$ ;  $I_{g1} = 12 \text{ A}$  and  $I_{g2} = 16 \text{ A}$ . Use sensitivity analysis to predict the values of  $v_1$  and  $v_2$  if the value of  $R_1$  is different by 10% from its nominal value.

### Solution

From Eqs. 4.95 and 4.96 we find the nominal values of  $v_1$  and  $v_2$ . Thus

$$v_1 = \frac{25\{3750(16) - [5(125) + 3750]12\}}{30(125) + 3750} = 25 \text{ V}, \quad (4.99)$$

and

$$v_2 = \frac{3750[30(16) - 25(12)]}{30(125) + 3750} = 90 \text{ V}. \quad (4.100)$$

Now from Eqs. 4.97 and 4.98 we can find the sensitivity of  $v_1$  and  $v_2$  to changes in  $R_1$ . Hence

$$\begin{aligned} \frac{dv_1}{dR_1} &= \frac{[3750 + 5(125)] - \{3750(16) - [3750 + 5(125)]12\}}{[(30)(125) + 3750]^2} \\ &= \frac{7}{12} \text{ V}/\Omega, \end{aligned} \quad (4.101)$$

and

$$\begin{aligned} \frac{dv_2}{dR_1} &= \frac{3750\{3750(16) - [5(125) + 3750]12\}}{(7500)^2} \\ &= 0.5 \text{ V}/\Omega. \end{aligned} \quad (4.102)$$

How do we use the results given by Eqs. 4.101 and 4.102? Assume that  $R_1$  is 10% less than its nominal value, that is,  $R_1 = 22.5 \Omega$ . Then  $\Delta R_1 = -2.5 \Omega$  and Eq. 4.101 predicts  $\Delta v_1$  will be

$$\Delta v_1 = \left( \frac{7}{12} \right) (-2.5) = -1.4583 \text{ V.}$$

Therefore, if  $R_1$  is 10% less than its nominal value, our analysis predicts that  $v_1$  will be

$$v_1 = 25 - 1.4583 = 23.5417 \text{ V.} \quad (4.103)$$

Similarly for Eq. 4.102 we have

$$\begin{aligned} \Delta v_2 &= 0.5(-2.5) = -1.25 \text{ V,} \\ v_2 &= 90 - 1.25 = 88.75 \text{ V.} \end{aligned} \quad (4.104)$$

We attempt to confirm the results in Eqs. 4.103 and 4.104 by substituting the value  $R_1 = 22.5 \Omega$  into Eqs. 4.95 and 4.96. When we do, the results are

$$v_1 = 23.4780 \text{ V,} \quad (4.105)$$

$$v_2 = 88.6960 \text{ V.} \quad (4.106)$$

Why is there a difference between the values predicted from the sensitivity analysis and the exact values computed by substituting for  $R_1$  in the equations for  $v_1$  and  $v_2$ ? We can see from Eqs. 4.97 and 4.98 that the sensitivity of  $v_1$  and  $v_2$  with respect to  $R_1$  is a function of  $R_1$ , because  $R_1$  appears in the denominator of both Eqs. 4.97 and 4.98. This means that as  $R_1$  changes, the sensitivities change and hence we cannot expect Eqs. 4.97 and 4.98 to give exact results for large changes in  $R_1$ . Note that for a 10% change in  $R_1$ , the percent error between the predicted and exact values of  $v_1$  and  $v_2$  is small. Specifically, the percent error in  $v_1 = 0.2713\%$  and the percent error in  $v_2 = 0.0676\%$ .

From this example, we can see that a tremendous amount of work is involved if we are to determine the sensitivity of  $v_1$  and  $v_2$  to changes in the remaining component values, namely  $R_2$ ,  $R_3$ ,  $R_4$ ,  $I_{g1}$ , and  $I_{g2}$ . Fortunately, PSpice has a sensitivity function that will perform sensitivity analysis for us. The sensitivity function in PSpice calculates two types of sensitivity. The first is known as the one-unit sensitivity, and the second is known as the 1% sensitivity. In the example circuit, a one-unit change in a resistor would change its value by  $1 \Omega$  and a one-unit change in a current source would change its value by  $1 \text{ A}$ . In contrast, 1% sensitivity analysis determines the effect of changing resistors or sources by 1% of their nominal values.

The result of PSpice sensitivity analysis of the circuit in Fig. 4.69 is shown in Table 4.2. Because we are analyzing a linear circuit, we can use superposition to predict values of  $v_1$  and  $v_2$  if more than one component's value changes. For example, let us assume  $R_1$  decreases to  $24 \Omega$  and  $R_2$  decreases to  $4 \Omega$ . From Table 4.2 we can combine the unit sensitivity of  $v_1$  to changes in  $R_1$  and  $R_2$  to get

$$\frac{\Delta v_1}{\Delta R_1} + \frac{\Delta v_1}{\Delta R_2} = 0.5833 - 5.417 = -4.8337 \text{ V}/\Omega.$$



Similarly,

$$\frac{\Delta v_2}{\Delta R_1} + \frac{\Delta v_2}{\Delta R_2} = 0.5 + 6.5 = 7.0 \text{ V}/\Omega.$$

Thus if both  $R_1$  and  $R_2$  decreased by  $1 \Omega$  we would predict

$$v_1 = 25 + 4.8227 = 29.8337 \text{ V},$$

$$v_2 = 90 - 7 = 83 \text{ V}.$$

**TABLE 4.2 PSpice Sensitivity Analysis Results**

Element Name	Element Value	Element Sensitivity (Volts/Unit)	Normalized Sensitivity (Volts/Percent)
<i>(a) DC Sensitivities of Node Voltage V1</i>			
R1	25	0.5833	0.1458
R2	5	-5.417	-0.2708
R3	50	0.45	0.225
R4	75	0.2	0.15
IG1	12	-14.58	-1.75
IG2	16	12.5	2
<i>(b) Sensitivities of Output V2</i>			
R1	25	0.5	0.125
R2	5	6.5	0.325
R3	50	0.54	0.27
R4	75	0.24	0.18
IG1	12	-12.5	-1.5
IG2	16	15	2.4

If we substitute  $R_1 = 24 \Omega$  and  $R_2 = 4 \Omega$  into Eqs. 4.95 and 4.96 we get

$$v_1 = 29.793 \text{ V},$$

$$v_2 = 82.759 \text{ V}.$$

In both cases our predictions are within a fraction of a volt of the actual node voltage values.

Circuit designers use the results of sensitivity analysis to determine which component value variation has the greatest impact on the output of the circuit. As we can see from the PSpice sensitivity analysis in Table 4.2, the node voltages  $v_1$  and  $v_2$  are much more sensitive to changes in  $R_2$  than to changes in  $R_1$ . Specifically,  $v_1$  is  $(5.417/0.5833)$  or approximately 9 times more sensitive to changes in  $R_2$  than to changes in  $R_1$  and  $v_2$  is  $(6.5/0.5)$  or 13 times more sensitive to changes in  $R_2$  than to changes in  $R_1$ . Hence in the example circuit, the tolerance on  $R_2$  must be more stringent than the tolerance on  $R_1$  if it is important to keep  $v_1$  and  $v_2$  close to their nominal values.

*NOTE: Assess your understanding of this Practical Perspective by trying Chapter Problems 4.105–4.107.*

## Summary

- For the topics in this chapter, mastery of some basic terms, and the concepts they represent, is necessary. Those terms are **node**, **essential node**, **path**, **branch**, **essential branch**, **mesh**, and **planar circuit**. Table 4.1 provides definitions and examples of these terms. (See page 91.)
- Two new circuit analysis techniques were introduced in this chapter:
  - The **node-voltage method** works with both planar and nonplanar circuits. A reference node is chosen from among the essential nodes. Voltage variables are assigned at the remaining essential nodes, and Kirchhoff's current law is used to write one equation per voltage variable. The number of equations is  $n_e - 1$ , where  $n_e$  is the number of essential nodes. (See page 93.)
  - The **mesh-current method** works only with planar circuits. Mesh currents are assigned to each mesh, and Kirchhoff's voltage law is used to write one equation per mesh. The number of equations is  $b - (n - 1)$ , where  $b$  is the number of branches in which the current is unknown, and  $n$  is the number of nodes. The mesh currents are used to find the branch currents. (See page 99.)
- Several new circuit simplification techniques were introduced in this chapter:
  - **Source transformations** allow us to exchange a voltage source ( $v_s$ ) and a series resistor ( $R$ ) for a current source ( $i_s$ ) and a parallel resistor ( $R$ ) and vice versa. The combinations must be equivalent in terms of their terminal voltage and current. Terminal equivalence holds provided that

$$i_s = \frac{v_s}{R}.$$

(See page 109.)

- **Thévenin equivalents** and **Norton equivalents** allow us to simplify a circuit comprised of sources and resistors into an equivalent circuit consisting of a voltage source and a series resistor (Thévenin) or a current source and a parallel resistor (Norton). The simplified circuit and the original circuit must be equivalent in terms of their terminal voltage and current. Thus keep in mind that (1) the Thévenin voltage ( $V_{Th}$ ) is the open-circuit voltage across the terminals of the original circuit, (2) the Thévenin resistance ( $R_{Th}$ ) is the ratio of the Thévenin voltage to the short-circuit current across the terminals of the original circuit; and (3) the Norton equivalent is obtained by performing a source transformation on a Thévenin equivalent. (See page 113.)
- **Maximum power transfer** is a technique for calculating the maximum value of  $p$  that can be delivered to a load,  $R_L$ . Maximum power transfer occurs when  $R_L = R_{Th}$ , the Thévenin resistance as seen from the resistor  $R_L$ . The equation for the maximum power transferred is

$$p = \frac{V_{Th}^2}{4R_L}.$$

(See page 120.)

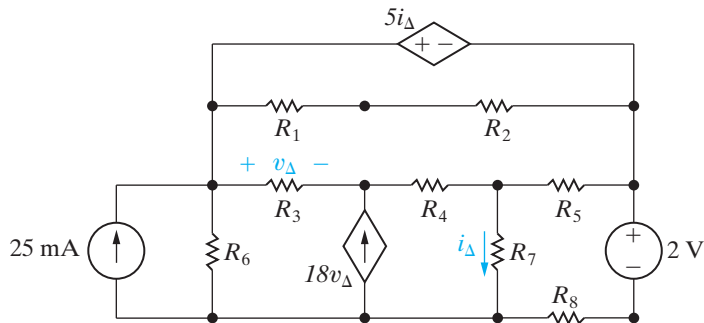
- In a circuit with multiple independent sources, **superposition** allows us to activate one source at a time and sum the resulting voltages and currents to determine the voltages and currents that exist when all independent sources are active. Dependent sources are never deactivated when applying superposition. (See page 122.)

## Problems

### Section 4.1

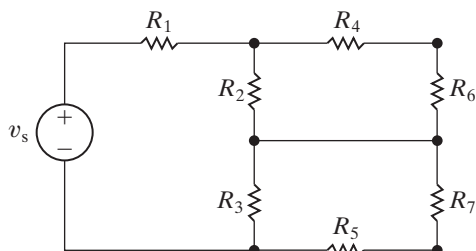
- 4.1** For the circuit shown in Fig. P4.1, state the numerical value of the number of (a) branches, (b) branches where the current is unknown, (c) essential branches, (d) essential branches where the current is unknown, (e) nodes, (f) essential nodes, and (g) meshes.

Figure P4.1



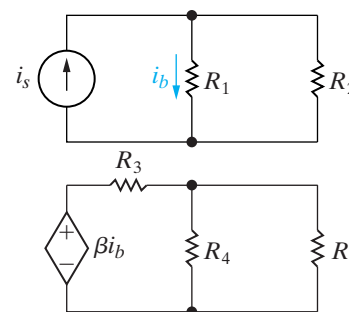
- 4.2** a) If only the essential nodes and branches are identified in the circuit in Fig. P4.1, how many simultaneous equations are needed to describe the circuit?  
 b) How many of these equations can be derived using Kirchhoff's current law?  
 c) How many must be derived using Kirchhoff's voltage law?  
 d) What two meshes should be avoided in applying the voltage law?
- 4.3** Assume the voltage  $v_s$  in the circuit in Fig. P4.3 is known. The resistors  $R_1 - R_7$  are also known.  
 a) How many unknown currents are there?  
 b) How many independent equations can be written using Kirchhoff's current law (KCL)?  
 c) Write an independent set of KCL equations.  
 d) How many independent equations can be derived from Kirchhoff's voltage law (KVL)?  
 e) Write a set of independent KVL equations.

Figure P4.3



- 4.4** A current leaving a node is defined as positive.  
 a) Sum the currents at each node in the circuit shown in Fig. P4.3.  
 b) Show that any one of the equations in (a) can be derived from the remaining three equations.
- 4.5** a) How many separate parts does the circuit in Fig. P4.5 have?  
 b) How many nodes?  
 c) How many branches are there?  
 d) Assume that the lower node in each part of the circuit is joined by a single conductor. Repeat the calculations in (a)–(c).

Figure P4.5

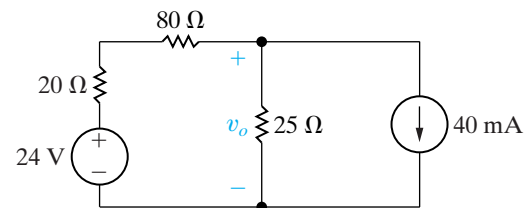


### Section 4.2

- 4.6** Use the node-voltage method to find  $v_o$  in the circuit in Fig. P4.6.

PSPICE  
MULTISIM

Figure P4.6



- 4.7** a) Find the power developed by the 40 mA current source in the circuit in Fig. P4.6.  
 b) Find the power developed by the 24 V voltage source in the circuit in Fig. P4.6.  
 c) Verify that the total power developed equals the total power dissipated.
- 4.8** A 50 Ω resistor is connected in series with the 40 mA current source in the circuit in Fig. P4.6.  
 a) Find  $v_o$ .  
 b) Find the power developed by the 40 mA current source.

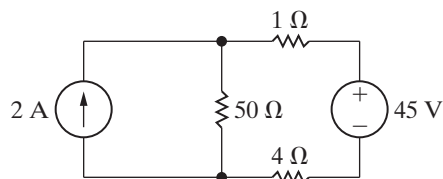
PSPICE  
MULTISIM

- c) Find the power developed by the 24 V voltage source.
- d) Verify that the total power developed equals the total power dissipated.
- e) What effect will any finite resistance connected in series with the 40 mA current source have on the value of  $v_o$ ?

**4.9** Use the node-voltage method to find how much power the 2 A source extracts from the circuit in Fig. P4.9.

PSPICE  
MULTISIM

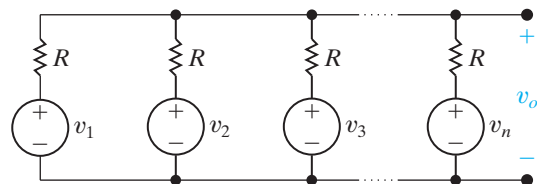
Figure P4.9



- 4.10** a) Use the node-voltage method to show that the output voltage  $v_o$  in the circuit in Fig. P4.10 is equal to the average value of the source voltages.
- b) Find  $v_o$  if  $v_1 = 100$  V,  $v_2 = 80$  V, and  $v_3 = -60$  V.

PSPICE  
MULTISIM

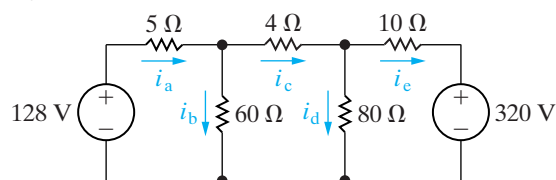
Figure P4.10



- 4.11** a) Use the node-voltage method to find the branch currents  $i_a - i_e$  in the circuit shown in Fig. P4.11.
- b) Find the total power developed in the circuit.

PSPICE  
MULTISIM

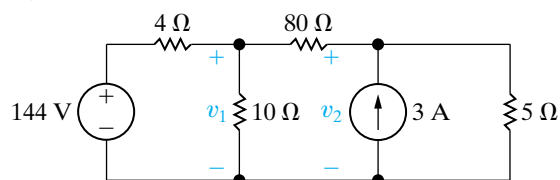
Figure P4.11



- 4.12** Use the node-voltage method to find  $v_1$  and  $v_2$  in the circuit in Fig. P4.12.

PSPICE  
MULTISIM

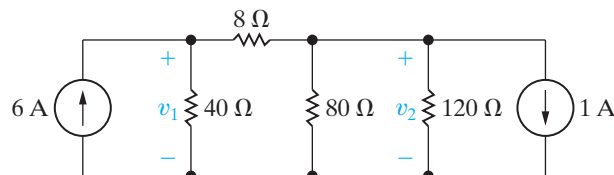
Figure P4.12



- 4.13** Use the node-voltage method to find  $v_1$  and  $v_2$  in the circuit shown in Fig. P4.13.

PSPICE  
MULTISIM

Figure P4.13

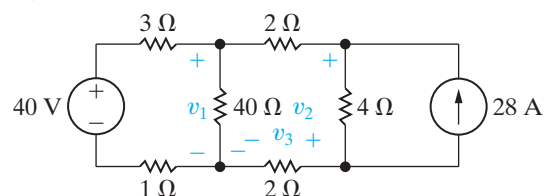


- 4.14** a) Use the node-voltage method to find  $v_1$ ,  $v_2$ , and  $v_3$  in the circuit in Fig. P4.14.

PSPICE  
MULTISIM

- b) How much power does the 40 V voltage source deliver to the circuit?

Figure P4.14

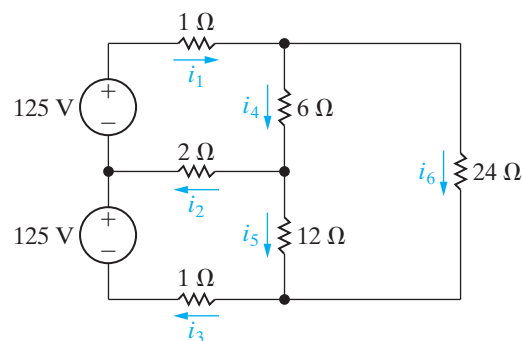


- 4.15** The circuit shown in Fig. P4.15 is a dc model of a residential power distribution circuit.

PSPICE  
MULTISIM

- a) Use the node-voltage method to find the branch currents  $i_1 - i_6$ .
- b) Test your solution for the branch currents by showing that the total power dissipated equals the total power developed.

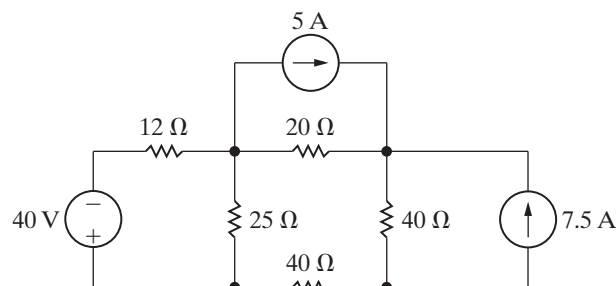
Figure P4.15



- 4.16** Use the node-voltage method to find the total power dissipated in the circuit in Fig. P4.16.

PSPICE  
MULTISIM

Figure P4.16

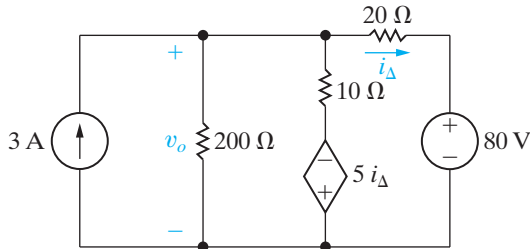


**Section 4.3**

- 4.17** a) Use the node-voltage method to find  $v_o$  in the circuit in Fig. P4.17.  
 b) Find the power absorbed by the dependent source.  
 c) Find the total power developed by the independent sources.

PSPICE  
MULTISIM

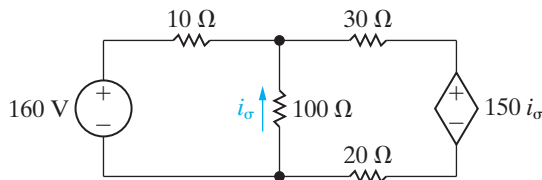
Figure P4.17



- 4.18** Use the node-voltage method to calculate the power delivered by the dependent voltage source in the circuit in Fig. P4.18.

PSPICE  
MULTISIM

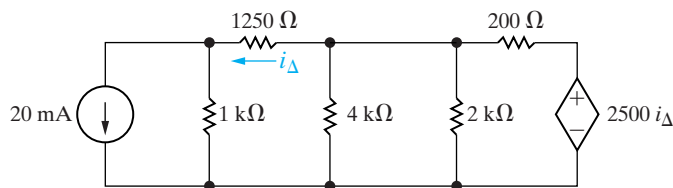
Figure P4.18



- 4.19** a) Use the node-voltage method to find the total power developed in the circuit in Fig. P4.19.  
 b) Check your answer by finding the total power absorbed in the circuit.

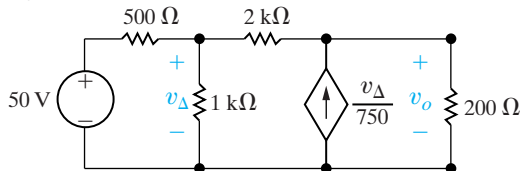
PSPICE  
MULTISIM

Figure P4.19



- 4.20** a) Use the node voltage method to find  $v_o$  for the circuit in Fig. P4.20.  
 b) Find the total power supplied in the circuit.

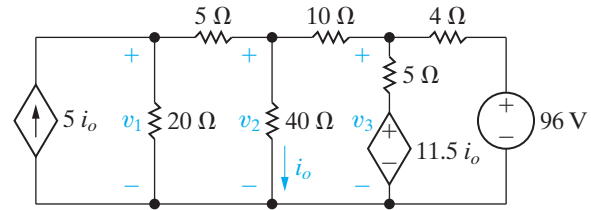
Figure P4.20



- 4.21** a) Find the node voltages  $v_1$ ,  $v_2$ , and  $v_3$  in the circuit in Fig. P4.21.  
 b) Find the total power dissipated in the circuit.

PSPICE  
MULTISIM

Figure P4.21

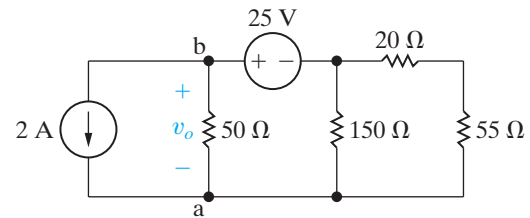


**Section 4.4**

- 4.22** a) Use the node-voltage method to find  $v_o$  and the power delivered by the 2 A current source in the circuit in Fig. P4.22. Use node a as the reference node.  
 b) Repeat part (a), but use node b as the reference node.  
 c) Compare the choice of reference node in (a) and (b). Which is better, and why?

PSPICE  
MULTISIM

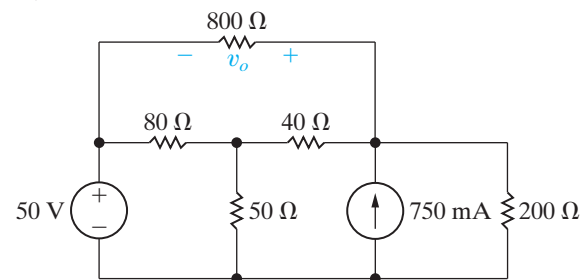
Figure P4.22



- 4.23** Use the node-voltage method to find the value of  $v_o$  in the circuit in Fig. P4.23.

PSPICE  
MULTISIM

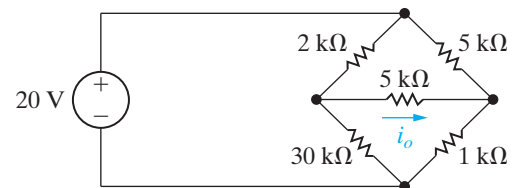
Figure P4.23



- 4.24** Use the node-voltage method to find  $i_o$  in the circuit in Fig. P4.24.

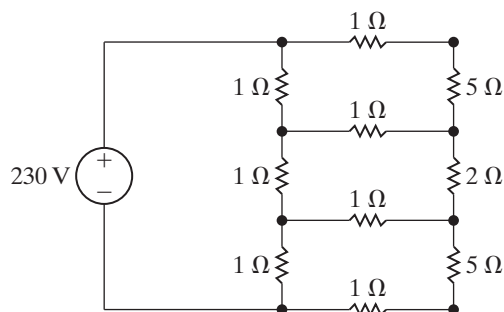
PSPICE  
MULTISIM

Figure P4.24



- 4.25** a) Use the node-voltage method to find the power dissipated in the 2 Ω resistor in the circuit in Fig. P4.25.  
 b) Find the power supplied by the 230 V source.

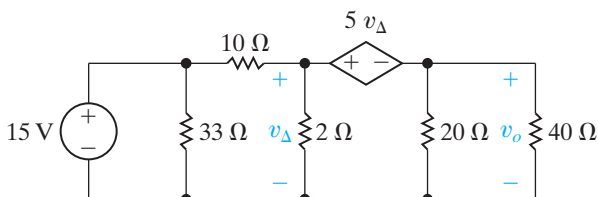
Figure P4.25



**4.26** Use the node-voltage method to find  $v_o$  in the circuit in Fig. P4.26.

PSPICE  
MULTISIM

Figure P4.26

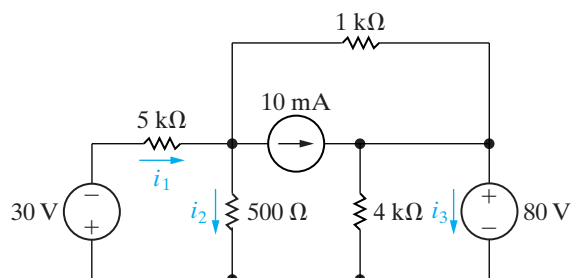


**4.27** a) Use the node-voltage method to find the branch currents  $i_1$ ,  $i_2$ , and  $i_3$  in the circuit in Fig. P4.27.

PSPICE  
MULTISIM

b) Check your solution for  $i_1$ ,  $i_2$ , and  $i_3$  by showing that the power dissipated in the circuit equals the power developed.

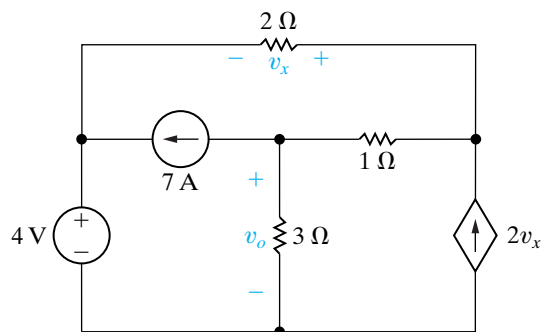
Figure P4.27



**4.28** Use the node-voltage method to find the value of  $v_o$  in the circuit in Fig. P4.28.

PSPICE  
MULTISIM

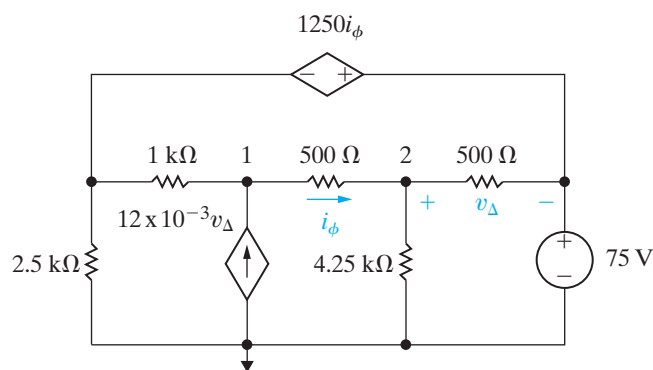
Figure P4.28



**4.29** Assume you are a project engineer and one of your staff is assigned to analyze the circuit shown in Fig. P4.29. The reference node and node numbers given on the figure were assigned by the analyst. Her solution gives the values of  $v_1$  and  $v_2$  as 105 V and 85 V, respectively.

- What values did the analyst use for the left-most and right-most node voltages when writing KCL equations at nodes 1 and 2?
- Use the values supplied by the analyst to calculate the total power developed in the circuit and the total power dissipated in the circuit.
- Do you agree with the solution submitted by the analyst?

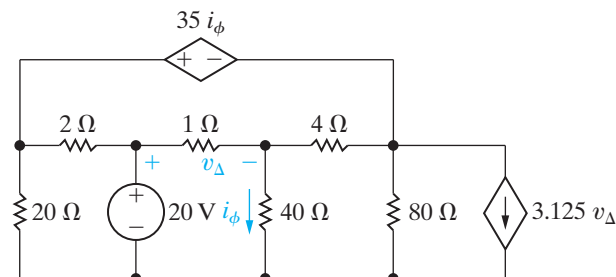
Figure P4.29



**4.30** Use the node-voltage method to find the power developed by the 20 V source in the circuit in Fig. P4.30.

PSPICE  
MULTISIM

Figure P4.30



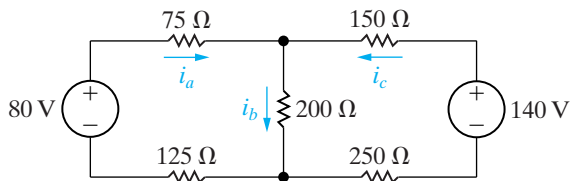
**4.31** Show that when Eqs. 4.16, 4.17, and 4.19 are solved for  $i_B$ , the result is identical to Eq. 2.25.

**4.32** a) Use the mesh-current method to find the branch currents  $i_a$ ,  $i_b$ , and  $i_c$  in the circuit in Fig. P4.32.

PSPICE  
MULTISIM

b) Repeat (a) if the polarity of the 140 V source is reversed.

Figure P4.32



Section 4.5

4.33 Solve Problem 4.11 using the mesh-current method.

4.34 Solve Problem 4.15 using the mesh-current method.

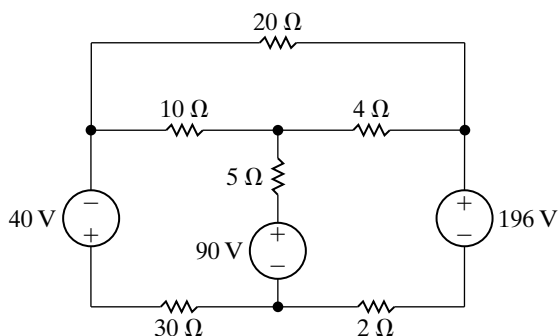
4.35 Solve Problem 4.24 using the mesh-current method.

4.36 a) Use the mesh-current method to find the total power developed in the circuit in Fig. P4.36.

PSPICE  
MULTISIM

b) Check your answer by showing that the total power developed equals the total power dissipated.

Figure P4.36



4.37 Solve Problem 4.25 using the mesh-current method.

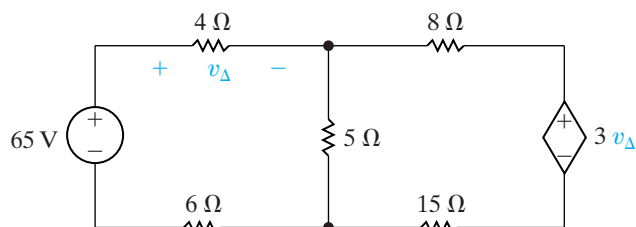
Section 4.6

4.38 Solve Problem 4.18 using the mesh-current method.

4.39 Use the mesh-current method to find the power dissipated in the 15 Ω resistor in the circuit in Fig. P4.39.

PSPICE  
MULTISIM

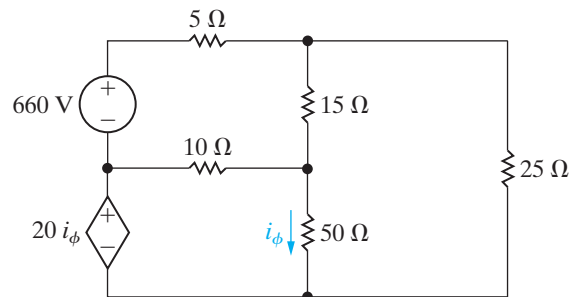
Figure P4.39



4.40 Use the mesh-current method to find the power delivered by the dependent voltage source in the circuit seen in Fig. P4.40.

PSPICE  
MULTISIM

Figure P4.40

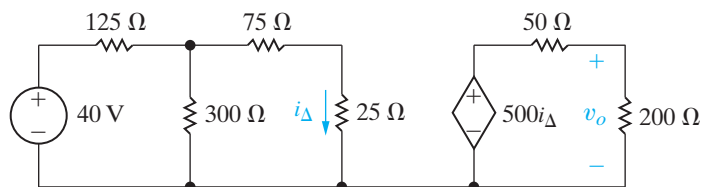


4.41 a) Use the mesh-current method to find  $v_o$  in the circuit in Fig. P4.41.

PSPICE  
MULTISIM

b) Find the power delivered by the dependent source.

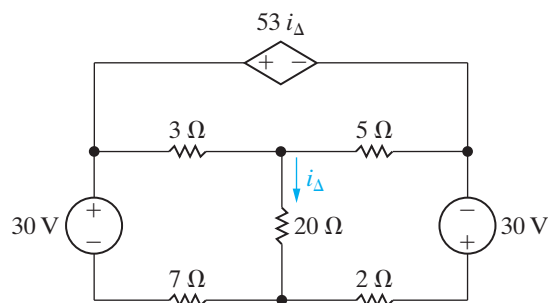
Figure P4.41



4.42 Use the mesh-current method to find the power developed in the dependent voltage source in the circuit in Fig. P4.42.

PSPICE  
MULTISIM

Figure P4.42



Section 4.7

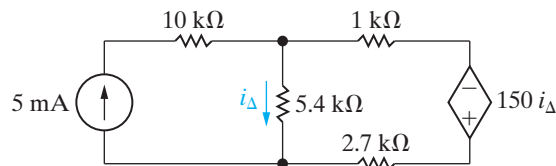
4.43 a) Use the mesh-current method to solve for  $i_Δ$  in the circuit in Fig. P4.43.

PSPICE  
MULTISIM

b) Find the power delivered by the independent current source.

c) Find the power delivered by the dependent voltage source.

Figure P4.43





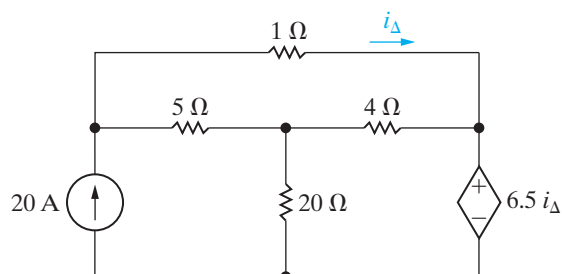
4.44 Solve Problem 4.13 using the mesh-current method.

4.45 Solve Problem 4.21 using the mesh-current method.

4.46 Use the mesh-current method to find the total power developed in the circuit in Fig. P4.46.

PSPICE  
MULTISIM

Figure P4.46

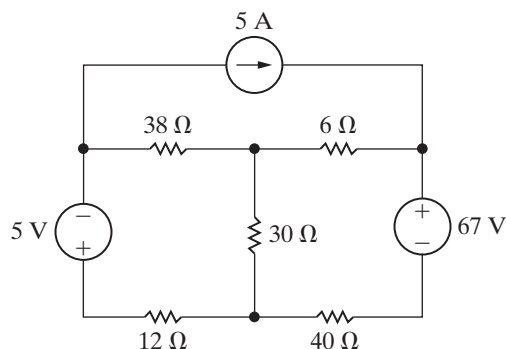


4.47 a) Use the mesh-current method to find how much power the 5 A current source delivers to the circuit in Fig. P4.47.

b) Find the total power delivered to the circuit.

c) Check your calculations by showing that the total power developed in the circuit equals the total power dissipated

Figure P4.47

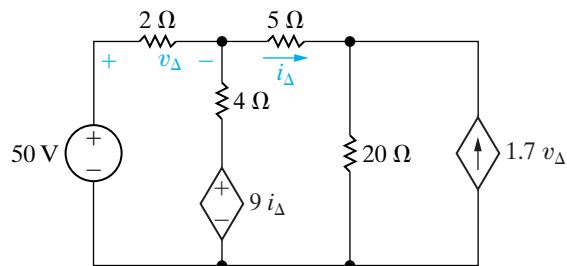


4.48 a) Use the mesh-current method to determine which sources in the circuit in Fig. P4.48 are generating power.

PSPICE  
MULTISIM

b) Find the total power dissipated in the circuit.

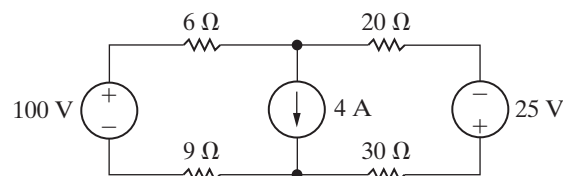
Figure P4.48



4.49 Use the mesh-current method to find the total power dissipated in the circuit in Fig. P4.49.

PSPICE  
MULTISIM

Figure P4.49



4.50 a) Assume the 100 V source in the circuit in Fig. P4.49 is changed to 67.5 V. Find the total power dissipated in the circuit.

b) Repeat (a) with the 4 A current source replaced by a short circuit.

c) Explain why the answers to (a) and (b) are the same.

c) Now assume you wish to change the value of the 25 V source, instead of the 100 V source, in the circuit in Fig. P4.49 to get the same power dissipated by the current source that you found in (a) and (b). Use the results in part (c) to calculate the new value of this voltage source.

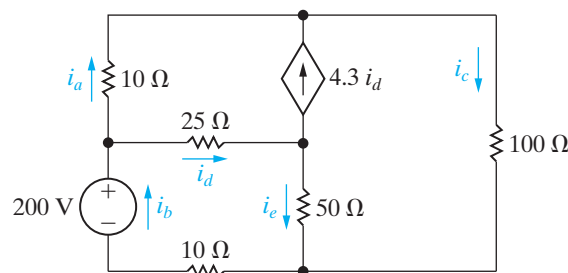
4.51 Solve Problem 4.27 using the mesh-current method.

4.52 a) Use the mesh-current method to find the branch currents in  $i_a - i_e$  in the circuit in Fig. P4.52.

PSPICE  
MULTISIM

b) Check your solution by showing that the total power developed in the circuit equals the total power dissipated.

Figure P4.52

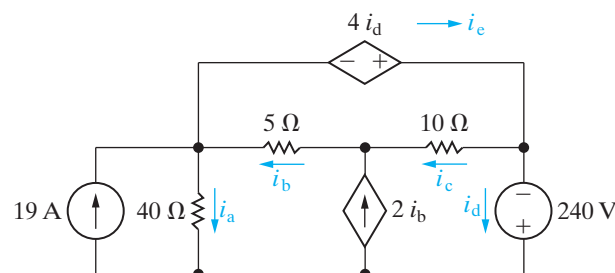


4.53 a) Find the branch currents  $i_a - i_e$  for the circuit shown in Fig. P4.53.

PSPICE  
MULTISIM

b) Check your answers by showing that the total power generated equals the total power dissipated.

Figure P4.53



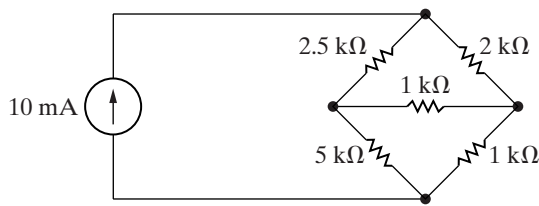
**Section 4.8**

**4.54** Assume you have been asked to find the power dissipated in the horizontal  $1\text{ k}\Omega$  resistor in the circuit in Fig. P4.54.

PSPICE  
MULTISIM

- Which method of circuit analysis would you recommend? Explain why.
- Use your recommended method of analysis to find the power dissipated in the horizontal  $1\text{ k}\Omega$  resistor.
- Would you change your recommendation if the problem had been to find the power developed by the  $10\text{ mA}$  current source? Explain.
- Find the power delivered by the  $10\text{ mA}$  current source.

**Figure P4.54**



**4.55** A  $4\text{ k}\Omega$  resistor is placed in parallel with the  $10\text{ mA}$  current source in the circuit in Fig. P4.54. Assume you have been asked to calculate the power developed by the current source.

PSPICE  
MULTISIM

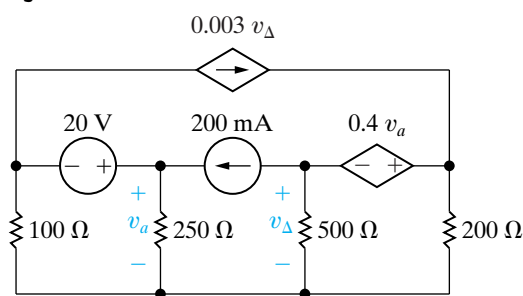
- Which method of circuit analysis would you recommend? Explain why.
- Find the power developed by the current source.

**4.56** a) Would you use the node-voltage or mesh-current method to find the power absorbed by the  $20\text{ V}$  source in the circuit in Fig. P4.56? Explain your choice.

PSPICE  
MULTISIM

- Use the method you selected in (a) to find the power.

**Figure P4.56**

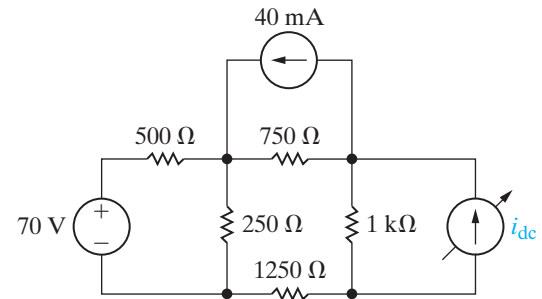


**4.57** The variable dc current source in the circuit in Fig. P4.57 is adjusted so that the power developed by the  $40\text{ mA}$  current source is zero. You want to find the value of  $i_{dc}$ .

PSPICE  
MULTISIM

- Would you use the node-voltage or mesh-current method to find  $i_{dc}$ ? Explain your choice.
- Use the method selected in (a) to find  $i_{dc}$ .

**Figure P4.57**

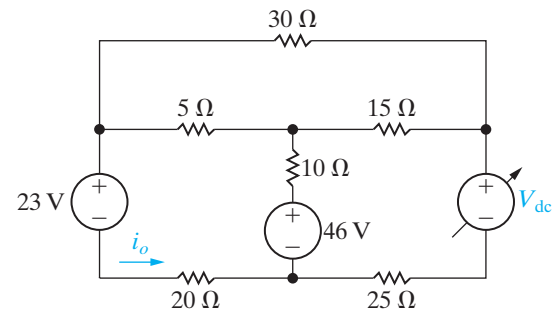


**4.58** The variable dc voltage source in the circuit in Fig. P4.58 is adjusted so that  $i_o$  is zero.

PSPICE  
MULTISIM

- Would you use the node-voltage or mesh-current method to find  $V_{dc}$ ? Explain your choice.
- Find the value of  $V_{dc}$ , using the method selected in (a).
- Check your solution by showing the power developed equals the power dissipated.

**Figure P4.58**

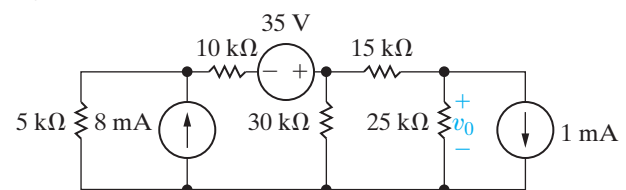


**Section 4.9**

**4.59** a) Make a series of source transformations to find the voltage  $v_o$  in the circuit in Fig. P4.59.

- Verify your solution using the mesh-current method.

**Figure P4.59**

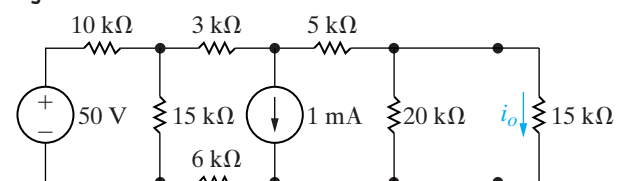


**4.60** a) Find the current  $i_o$  in the circuit in Fig. P4.60 by making a succession of appropriate source transformations.

PSPICE  
MULTISIM

- Using the result obtained in (a), work back through the circuit to find the power developed by the  $50\text{ V}$  source.

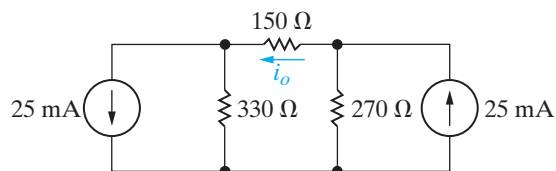
**Figure P4.60**



- 4.61** a) Use source transformations to find the current  $i_o$  in the circuit in Fig. P4.61.  
 b) Verify your solution by using the node-voltage method to find  $i_o$ .

PSPICE  
MULTISIM

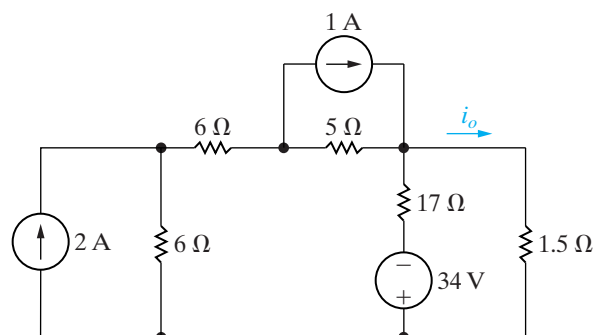
Figure P4.61



- 4.62** a) Use a series of source transformations to find  $i_o$  in the circuit in Fig. P4.62.  
 b) Verify your solution by using the mesh-current method to find  $i_o$ .

PSPICE  
MULTISIM

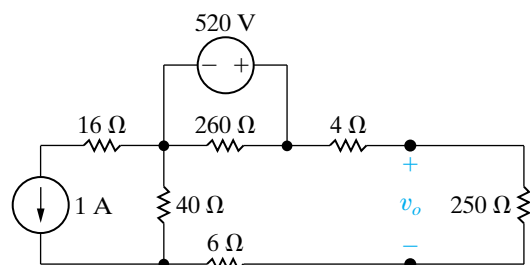
Figure P4.62



- 4.63** a) Use source transformations to find  $v_o$  in the circuit in Fig. P4.63.  
 b) Find the power developed by the 520 V source.  
 c) Find the power developed by the 1 A current source.  
 d) Verify that the total power developed equals the total power dissipated.

PSPICE  
MULTISIM

Figure P4.63

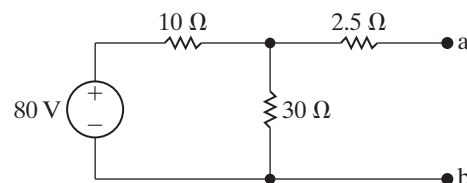


### Section 4.10

- 4.64** Find the Thévenin equivalent with respect to the terminals a,b for the circuit in Fig. P4.64.

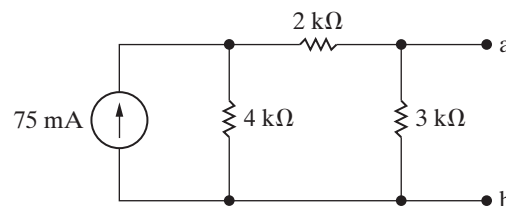
PSPICE  
MULTISIM

Figure P4.64



- 4.65** Find the Norton equivalent with respect to the terminals a,b for the circuit in Fig. P4.65.

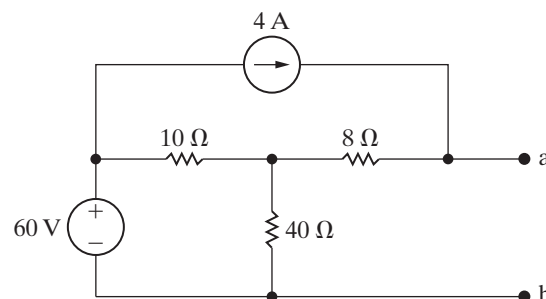
Figure P4.65



- 4.66** Find the Norton equivalent with respect to the terminals a,b for the circuit in Fig. P4.66.

PSPICE  
MULTISIM

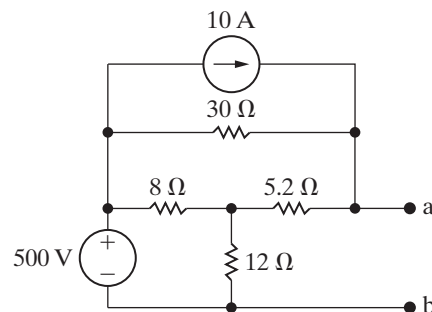
Figure P4.66



- 4.67** Find the Thévenin equivalent with respect to the terminals a,b for the circuit in Fig. P4.67.

PSPICE  
MULTISIM

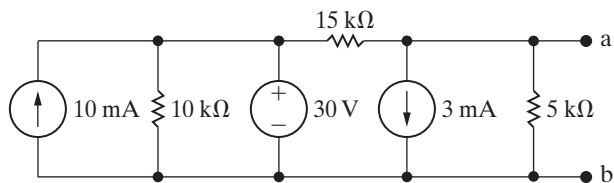
Figure P4.67



- 4.68** Find the Norton equivalent with respect to the terminals a,b in the circuit in Fig. P4.68.

PSPICE  
MULTISIM

Figure P4.68



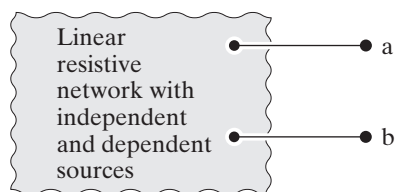
4.69 A Thévenin equivalent can also be determined from measurements made at the pair of terminals of interest. Assume the following measurements were made at the terminals a,b in the circuit in Fig. P4.69.

When a  $20\ \Omega$  resistor is connected to the terminals a,b, the voltage  $v_{ab}$  is measured and found to be 100 V.

When a  $50\ \Omega$  resistor is connected to the terminals a,b, the voltage is measured and found to be 200 V.

Find the Thévenin equivalent of the network with respect to the terminals a,b.

Figure P4.69

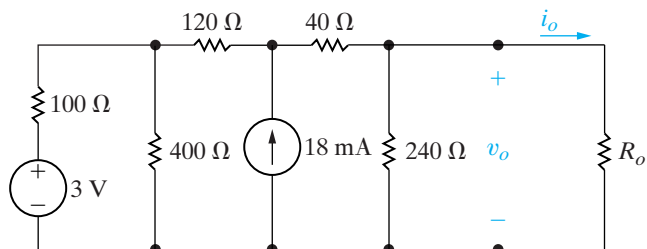


4.70 An automobile battery, when connected to a car radio, provides 12.5 V to the radio. When connected to a set of headlights, it provides 11.7 V to the headlights. Assume the radio can be modeled as a  $6.25\ \Omega$  resistor and the headlights can be modeled as a  $0.65\ \Omega$  resistor. What are the Thévenin and Norton equivalents for the battery?

4.71 Determine  $i_o$  and  $v_o$  in the circuit shown in Fig. P4.71 when  $R_o$  is a resistor from Appendix H such that  $100\ \Omega \leq R_o < 200\ \Omega$ .

PSPICE  
MULTISIM

Figure P4.71

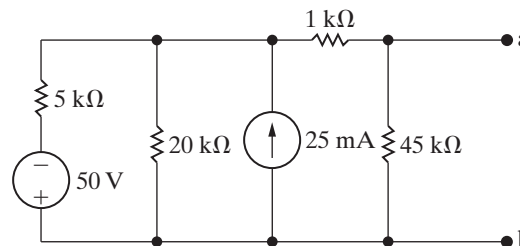


4.72 A voltmeter with a resistance of  $85.5\ \text{k}\Omega$  is used to measure the voltage  $v_{ab}$  in the circuit in Fig. P4.72.

PSPICE  
MULTISIM

- What is the voltmeter reading?
- What is the percentage of error in the voltmeter reading if the percentage of error is defined as  $[(\text{measured} - \text{actual})/\text{actual}] \times 100\%$ ?

Figure P4.72

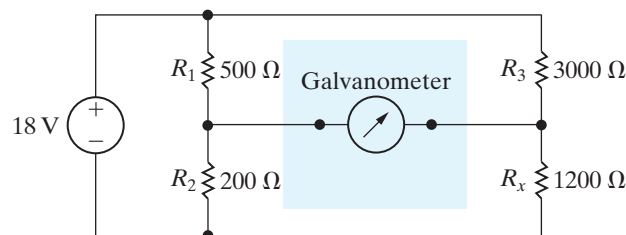


4.73 The Wheatstone bridge in the circuit shown in Fig. P4.73 is balanced when  $R_3$  equals  $3000\ \Omega$ . If the galvanometer has a resistance of  $50\ \Omega$ , how much current will the galvanometer detect, when the bridge is unbalanced by setting  $R_3$  to  $3003\ \Omega$ ?

PSPICE  
MULTISIM

(Hint: Find the Thévenin equivalent with respect to the galvanometer terminals when  $R_3 = 3003\ \Omega$ . Note that once we have found this Thévenin equivalent, it is easy to find the amount of unbalanced current in the galvanometer branch for different galvanometer movements.)

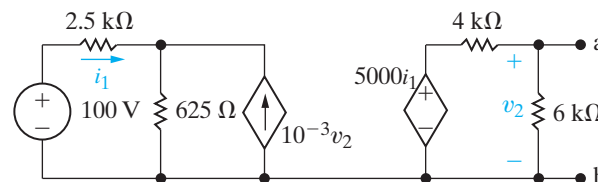
Figure P4.73



4.74 Determine the Thévenin equivalent with respect to the terminals a,b for the circuit shown in Fig. P4.74.

PSPICE  
MULTISIM

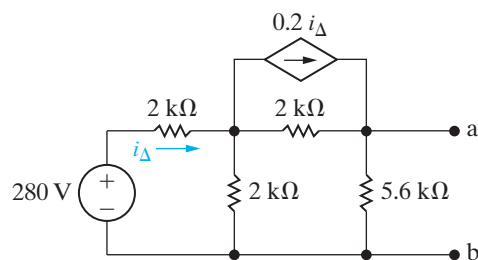
Figure P4.74



- 4.75** Find the Norton equivalent with respect to the terminals a,b for the circuit seen in Fig. P4.75.

PSPICE  
MULTISIM

Figure P4.75

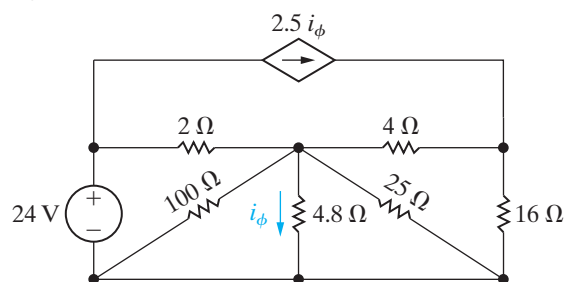


- 4.76** When an ammeter is used to measure the current  $i_\phi$  in the circuit shown in Fig. P4.76, it reads 6 A.

PSPICE  
MULTISIM

- What is the resistance of the ammeter?
- What is the percentage of error in the current measurement?

Figure P4.76



### Section 4.11

- 4.77** a) Find the Thévenin equivalent resistance with respect to the terminals a,b in the circuit in Fig. P4.64 without finding either the open circuit voltage or the short circuit current.

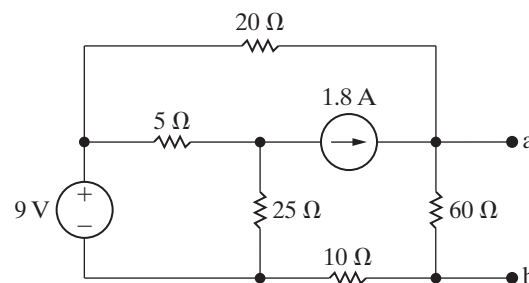
- b) Find the Norton equivalent resistance with respect to the terminals a,b in the circuit in Fig. P4.66 without finding either the open circuit voltage or the short circuit current.

- 4.78** a) Find the Thévenin equivalent with respect to the terminals a,b for the circuit in Fig. P4.78 by finding the open-circuit voltage and the short-circuit current.

PSPICE  
MULTISIM

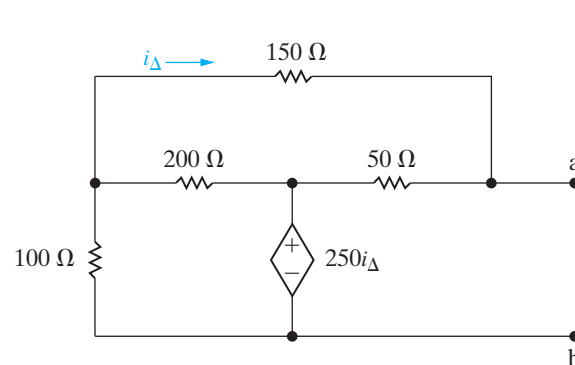
- b) Solve for the Thévenin resistance by removing the independent sources. Compare your result to the Thévenin resistance found in (a).

Figure P4.78



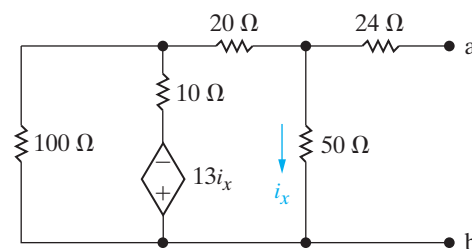
- 4.79** Find the Thévenin equivalent with respect to the terminals a,b in the circuit in Fig. P4.79.

Figure P4.79



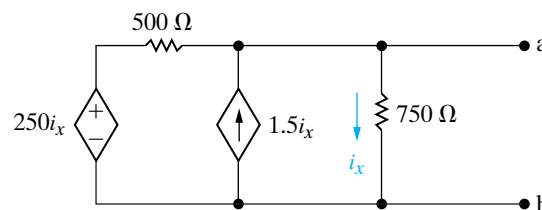
- 4.80** Find the Thévenin equivalent with respect to the terminals a,b in the circuit in Fig. P4.80.

Figure P4.80



- 4.81** Find the Norton equivalent with respect to the terminals a,b for the circuit seen in Fig. P4.81.

Figure P4.81



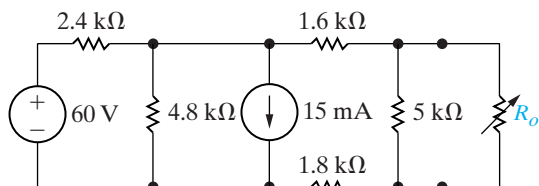
**Section 4.12**

**4.82** The variable resistor in the circuit in Fig. P4.82 is adjusted for maximum power transfer to  $R_o$ .

PSPICE  
MULTISIM

- Find the value of  $R_o$ .
- Find the maximum power that can be delivered to  $R_o$ .
- Find a resistor in Appendix H closest to the value in part (a). How much power is delivered to this resistor?

**Figure P4.82**



**4.83** What percentage of the total power developed in the circuit in Fig. P4.82 is delivered to  $R_o$  when  $R_o$  is set for maximum power transfer?

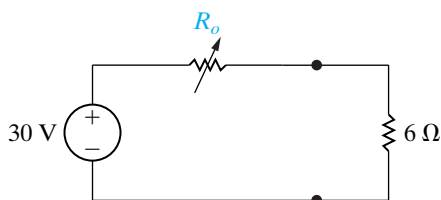
PSPICE  
MULTISIM

- Calculate the power delivered for each value of  $R_o$  used in Problem 4.71.
- Plot the power delivered to  $R_o$  versus the resistance  $R_o$ .
- At what value of  $R_o$  is the power delivered to  $R_o$  a maximum?

**4.85** a) Find the value of the variable resistor  $R_o$  in the circuit in Fig. P4.85 that will result in maximum power dissipation in the  $6 \Omega$  resistor. (*Hint: Hasty conclusions could be hazardous to your career.*)

- What is the maximum power that can be delivered to the  $6 \Omega$  resistor?

**Figure P4.85**



**4.86** A variable resistor  $R_o$  is connected across the terminals a,b in the circuit in Fig. P4.75. The variable resistor is adjusted until maximum power is transferred to  $R_o$ .

PSPICE  
MULTISIM

- Find the value of  $R_o$ .
- Find the maximum power delivered to  $R_o$ .
- Find the percentage of the total power developed in the circuit that is delivered to  $R_o$ .

d) Find the resistor from Appendix H closest in value to the  $R_o$  from part (a).

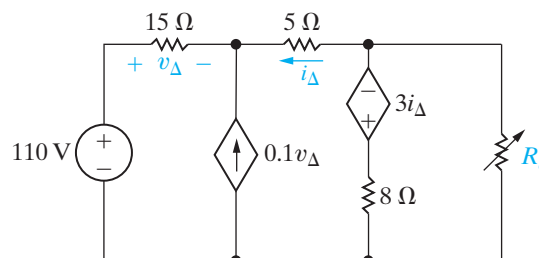
e) Find the percentage of the total power developed in the circuit that is delivered to the resistor in part (d).

**4.87** The variable resistor ( $R_o$ ) in the circuit in Fig. P4.87 is adjusted until it absorbs maximum power from the circuit.

PSPICE  
MULTISIM

- Find the value of  $R_o$ .
- Find the maximum power.
- Find the percentage of the total power developed in the circuit that is delivered to  $R_o$ .

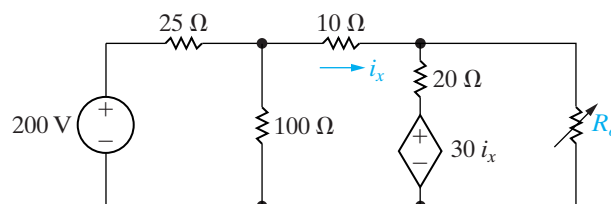
**Figure P4.87**



**4.88** The variable resistor ( $R_o$ ) in the circuit in Fig. P4.88 is adjusted until the power dissipated in the resistor is 250 W. Find the values of  $R_o$  that satisfy this condition.

PSPICE  
MULTISIM

**Figure P4.88**

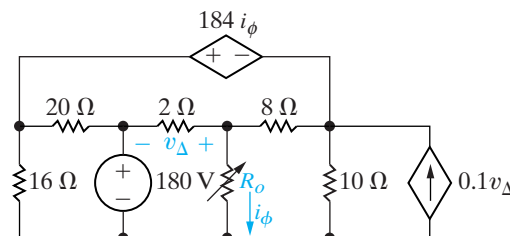


**4.89** The variable resistor in the circuit in Fig. P4.89 is adjusted for maximum power transfer to  $R_o$ .

PSPICE  
MULTISIM

- Find the numerical value of  $R_o$ .
- Find the maximum power delivered to  $R_o$ .
- How much power does the 180 V source deliver to the circuit when  $R_o$  is adjusted to the value found in (a)?

**Figure P4.89**

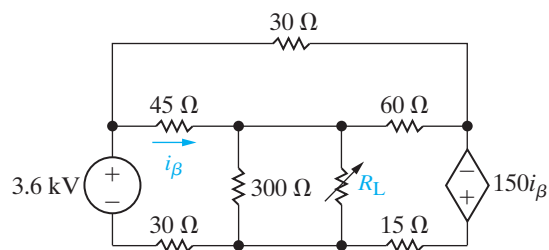


**4.90** The variable resistor ( $R_L$ ) in the circuit in Fig. P4.90 is adjusted for maximum power transfer to  $R_L$ .

PSPICE  
MULTISIM

- Find the numerical value of  $R_L$ .
- Find the maximum power transferred to  $R_L$ .

Figure P4.90

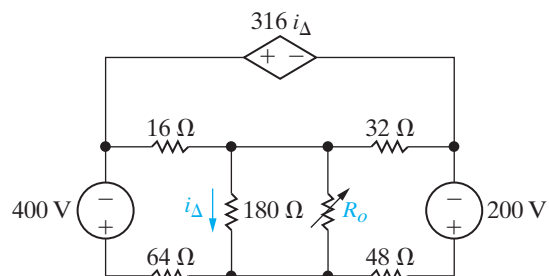


**4.91** The variable resistor ( $R_o$ ) in the circuit in Fig. P4.91 is adjusted for maximum power transfer to  $R_o$ .

PSPICE  
MULTISIM

- Find the value of  $R_o$ .
- Find the maximum power that can be delivered to  $R_o$ .
- What percentage of the total power developed in the circuit is delivered to  $R_o$  found in part(a)?
- If  $R_o$  is selected from Appendix H, which resistor value will result in the greatest amount of power delivered to  $R_o$ ?

Figure P4.91



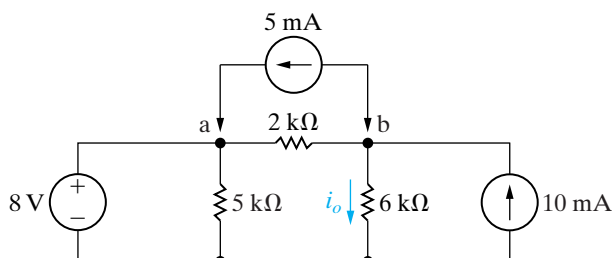
### Section 4.13

**4.92** a) In the circuit in Fig. P4.92, before the 5 mA current source is attached to the terminals a,b, the current  $i_o$  is calculated and found to be 3.5 mA. Use superposition to find the value of  $i_o$  after the current source is attached.

PSPICE  
MULTISIM

- Verify your solution by finding  $i_o$  when all three sources are acting simultaneously.

Figure P4.92

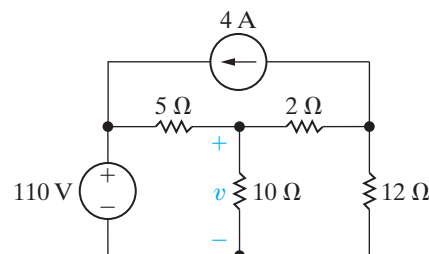


**4.93** a) Use the principle of superposition to find the voltage  $v$  in the circuit of Fig. P4.93.

PSPICE  
MULTISIM

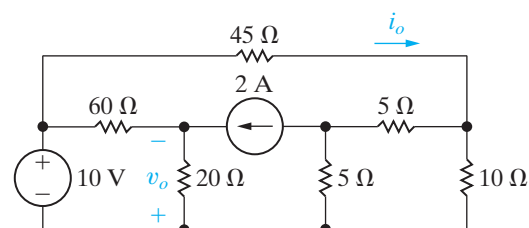
- Find the power dissipated in the 10 Ω resistor.

Figure P4.93



**4.94** Use superposition to solve for  $i_o$  and  $v_o$  in the circuit in Fig. P4.94.

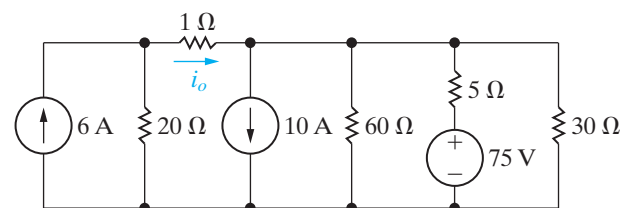
Figure P4.94



**4.95** Use the principle of superposition to find the current  $i_o$  in the circuit shown in Fig. P4.95.

PSPICE  
MULTISIM

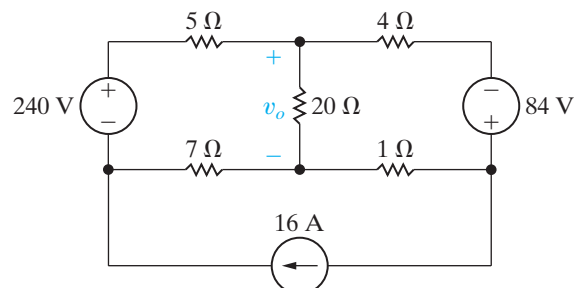
Figure P4.95



**4.96** Use the principle of superposition to find the voltage  $v_o$  in the circuit in Fig. P4.96.

PSPICE  
MULTISIM

Figure P4.96

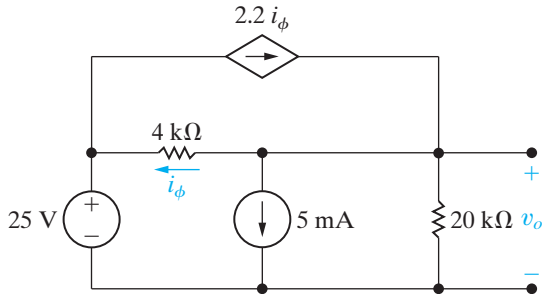




**4.97** Use the principle of superposition to find  $v_o$  in the circuit in Fig. P4.97.

PSPICE  
MULTISIM

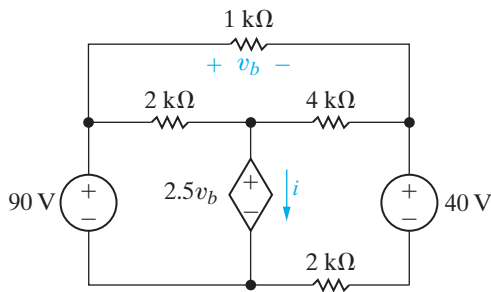
Figure P4.97



**4.98** Use the principle of superposition to find the current  $i$  in the circuit of Fig. P4.98.

PSPICE  
MULTISIM

Figure P4.98

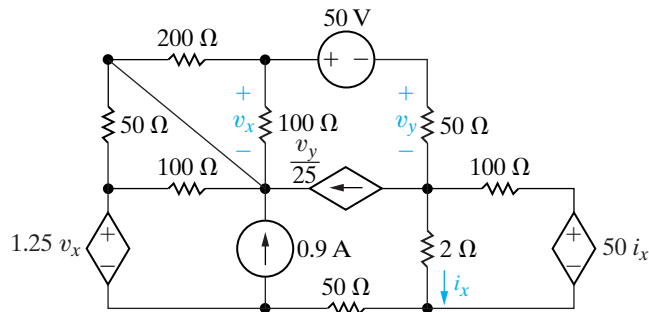


**Sections 4.1–4.13**

**4.99** Assume your supervisor has asked you to determine the power developed by the 50 V source in the circuit in Fig. P4.99. Before calculating the power developed by the 50 V source, the supervisor asks you to submit a proposal describing how you plan to attack the problem. Furthermore, he asks you to explain why you have chosen your proposed method of solution.

- Describe your plan of attack, explaining your reasoning.
- Use the method you have outlined in (a) to find the power developed by the 50 V source.

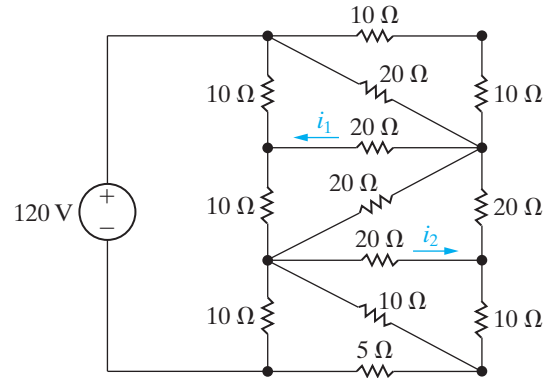
Figure P4.99



**4.100** Find  $i_1$  and  $i_2$  in the circuit in Fig. P4.100.

PSPICE  
MULTISIM

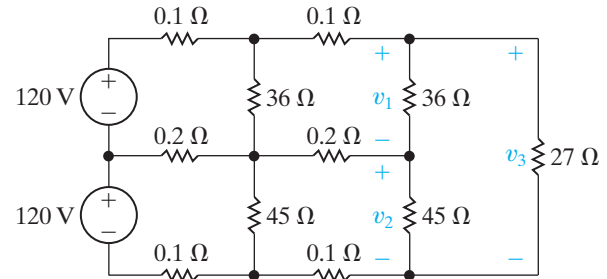
Figure P4.100



**4.101** Find  $v_1$ ,  $v_2$ , and  $v_3$  in the circuit in Fig. P4.101.

PSPICE  
MULTISIM

Figure P4.101



**4.102** Two ideal dc voltage sources are connected by electrical conductors that have a resistance of  $r \Omega/\text{m}$ , as shown in Fig. P4.102. A load having a resistance of  $R \Omega$  moves between the two voltage sources. Let  $x$  equal the distance between the load and the source  $v_1$ , and let  $L$  equal the distance between the sources.

- Show that

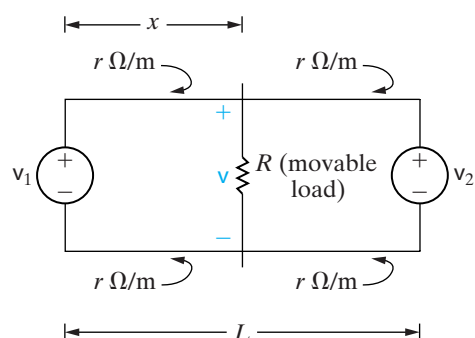
$$v = \frac{v_1 RL + R(v_2 - v_1)x}{RL + 2rLx - 2rx^2}.$$

- Show that the voltage  $v$  will be minimum when

$$x = \frac{L}{v_2 - v_1} \left[ -v_1 \pm \sqrt{v_1 v_2 - \frac{R}{2rL}(v_1 - v_2)^2} \right].$$

- Find  $x$  when  $L = 16 \text{ km}$ ,  $v_1 = 1000 \text{ V}$ ,  $v_2 = 1200 \text{ V}$ ,  $R = 3.9 \Omega$ , and  $r = 5 \times 10^{-5} \Omega/\text{m}$ .
- What is the minimum value of  $v$  for the circuit of part (c)?

Figure P4.102



**4.103** Laboratory measurements on a dc voltage source yield a terminal voltage of 75 V with no load connected to the source and 60 V when loaded with a 20  $\Omega$  resistor.

PSPICE  
MULTISIM

- What is the Thévenin equivalent with respect to the terminals of the dc voltage source?
- Show that the Thévenin resistance of the source is given by the expression

$$R_{\text{Th}} = \left( \frac{v_{\text{Th}}}{v_o} - 1 \right) R_L,$$

where

$v_{\text{Th}}$  = the Thévenin voltage,

$v_o$  = the terminal voltage corresponding to the load resistance  $R_L$ .

**4.104** For the circuit in Fig. 4.69 derive the expressions for the sensitivity of  $v_1$  and  $v_2$  to changes in the source currents  $I_{g1}$  and  $I_{g2}$ .

DESIGN  
PROBLEM

**4.105** Assume the nominal values for the components in the circuit in Fig. 4.69 are:  $R_1 = 25 \Omega$ ;  $R_2 = 5 \Omega$ ;  $R_3 = 50 \Omega$ ;  $R_4 = 75 \Omega$ ;  $I_{g1} = 12 \text{ A}$ ; and  $I_{g2} = 16 \text{ A}$ . Predict the values of  $v_1$  and  $v_2$  if  $I_{g1}$  decreases to 11 A and all other components stay at their nominal values. Check your predictions using a tool like PSpice or MATLAB.

PRACTICAL  
PERSPECTIVE  
PSPICE  
MULTISIM

**4.106** Repeat Problem 4.105 if  $I_{g2}$  increases to 17 A, and all other components stay at their nominal values. Check your predictions using a tool like PSpice or MATLAB.

PRACTICAL  
PERSPECTIVE

**4.107** Repeat Problem 4.105 if  $I_{g1}$  decreases to 11 A and  $I_{g2}$  increases to 17 A. Check your predictions using a tool like PSpice or MATLAB.

PRACTICAL  
PERSPECTIVE  
PSPICE  
MULTISIM

**4.108** Use the results given in Table 4.2 to predict the values of  $v_1$  and  $v_2$  if  $R_1$  and  $R_3$  increase to 10% above their nominal values and  $R_2$  and  $R_4$  decrease to 10% below their nominal values.  $I_{g1}$  and  $I_{g2}$  remain at their nominal values. Compare your predicted values of  $v_1$  and  $v_2$  with their actual values.

PRACTICAL  
PERSPECTIVE

## CHAPTER CONTENTS

- 5.1 Operational Amplifier Terminals *p. 146*
- 5.2 Terminal Voltages and Currents *p. 146*
- 5.3 The Inverting-Amplifier Circuit *p. 150*
- 5.4 The Summing-Amplifier Circuit *p. 152*
- 5.5 The Noninverting-Amplifier Circuit *p. 153*
- 5.6 The Difference-Amplifier Circuit *p. 155*
- 5.7 A More Realistic Model for the Operational Amplifier *p. 159*

## ✓ CHAPTER OBJECTIVES

- 1 Be able to name the five op amp terminals and describe and use the voltage and current constraints and the resulting simplifications they lead to in an ideal op amp.
- 2 Be able to analyze simple circuits containing ideal op amps, and recognize the following op amp circuits: inverting amplifier, summing amplifier, noninverting amplifier, and difference amplifier.
- 3 Understand the more realistic model for an op amp and be able to use this model to analyze simple circuits containing op amps.

# The Operational Amplifier

The electronic circuit known as an operational amplifier has become increasingly important. However, a detailed analysis of this circuit requires an understanding of electronic devices such as diodes and transistors. You may wonder, then, why we are introducing the circuit before discussing the circuit's electronic components. There are several reasons. First, you can develop an appreciation for how the operational amplifier can be used as a circuit building block by focusing on its terminal behavior. At an introductory level, you need not fully understand the operation of the electronic components that govern terminal behavior. Second, the circuit model of the operational amplifier requires the use of a dependent source. Thus you have a chance to use this type of source in a practical circuit rather than as an abstract circuit component. Third, you can combine the operational amplifier with resistors to perform some very useful functions, such as scaling, summing, sign changing, and subtracting. Finally, after introducing inductors and capacitors in Chapter 6, we can show you how to use the operational amplifier to design integrating and differentiating circuits.

Our focus on the terminal behavior of the operational amplifier implies taking a black box approach to its operation; that is, we are not interested in the internal structure of the amplifier nor in the currents and voltages that exist in this structure. The important thing to remember is that the internal behavior of the amplifier accounts for the voltage and current constraints imposed at the terminals. (For now, we ask that you accept these constraints on faith.)

## Practical Perspective

### Strain Gages

How could you measure the amount of bending in a metal bar such as the one shown in the figure without physically contacting the bar? One method would be to use a strain gage. A strain gage is a type of **transducer**. A transducer is a device that measures a quantity by converting it into a more convenient form. The quantity we wish to measure in the metal bar is the bending angle, but measuring the angle directly is quite difficult and could even be dangerous. Instead, we attach a strain gage (shown in the line drawing here) to the metal bar. A strain gage is a grid of thin wires whose resistance changes when the wires are lengthened or shortened:

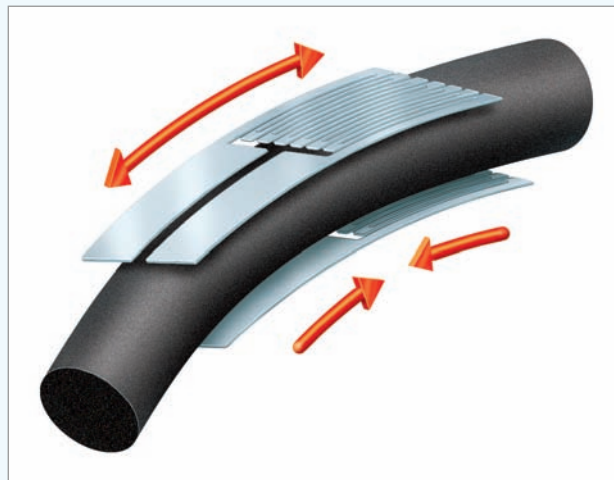
$$\Delta R = 2R \frac{\Delta L}{L}$$

where  $R$  is the resistance of the gage at rest,  $\Delta L/L$  is the fractional lengthening of the gage (which is the definition of "strain"), the constant 2 is typical of the manufacturer's gage factor, and  $\Delta R$  is the change in resistance due to the bending of the bar. Typically, pairs of strain gages are attached to opposite sides of a bar. When the bar is bent, the wires in one pair of gages get longer and thinner, increasing the resistance, while the wires in the other pair of gages get shorter and thicker, decreasing the resistance.

But how can the change in resistance be measured? One way would be to use an ohmmeter. However, the change in resistance experienced by the strain gage is typically much smaller than could be accurately measured by an ohmmeter. Usually the pairs of strain gages are connected to form a Wheatstone bridge, and the voltage difference between two legs of the bridge is measured. In order to make an accurate

measurement of the voltage difference, we use an operational amplifier circuit to amplify, or increase, the voltage difference. After we introduce the operational amplifier and some of the important circuits that employ these devices, we will present the circuit used together with the strain gages for measuring the amount of bending in a metal bar.

The operational amplifier circuit first came into existence as a basic building block in analog computers. It was referred to as *operational* because it was used to implement the mathematical operations of integration, differentiation, addition, sign changing, and scaling. In recent years, the range of application has broadened beyond implementing mathematical operations; however, the original name for the circuit persists. Engineers and technicians have a penchant for creating technical jargon; hence the operational amplifier is widely known as the **op amp**.



Ron Chapple/Corbis

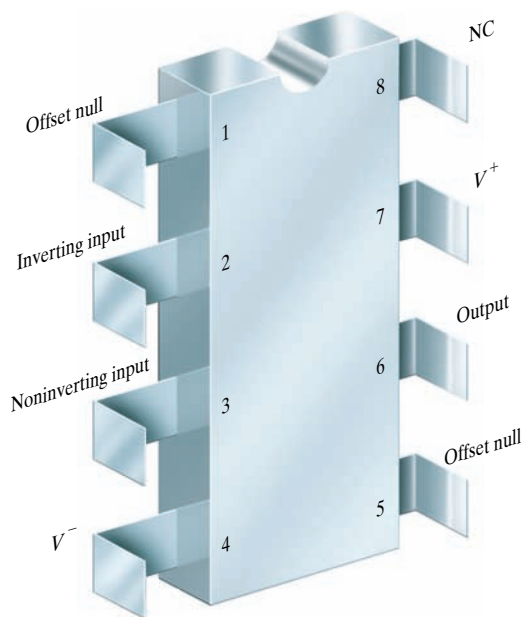


Figure 5.1 ▲ The eight-lead DIP package (top view).

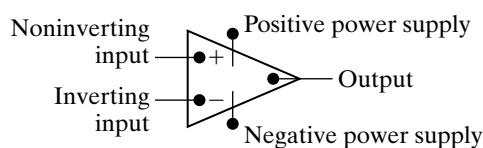


Figure 5.2 ▲ The circuit symbol for an operational amplifier (op amp).

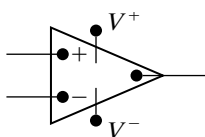


Figure 5.3 ▲ A simplified circuit symbol for an op amp.

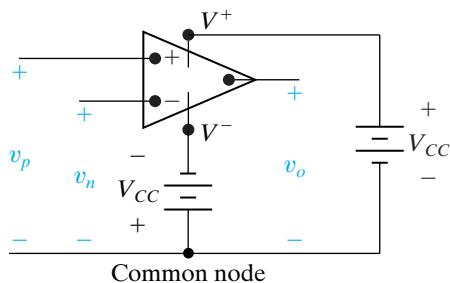


Figure 5.4 ▲ Terminal voltage variables.

## 5.1 Operational Amplifier Terminals

Because we are stressing the terminal behavior of the operational amplifier (op amp), we begin by discussing the terminals on a commercially available device. In 1968, Fairchild Semiconductor introduced an op amp that has found widespread acceptance: the  $\mu\text{A}741$ . (The  $\mu\text{A}$  prefix is used by Fairchild to indicate a microcircuit fabrication of the amplifier.) This amplifier is available in several different packages. For our discussion, we assume an eight-lead DIP.<sup>1</sup> Figure 5.1 shows a top view of the package, with the terminal designations given alongside the terminals. The terminals of primary interest are

- inverting input,
- noninverting input,
- output,
- positive power supply ( $V^+$ ),
- negative power supply ( $V^-$ ).

The remaining three terminals are of little or no concern. The offset null terminals may be used in an auxiliary circuit to compensate for a degradation in performance because of aging and imperfections. However, the degradation in most cases is negligible, so the offset terminals often are unused and play a secondary role in circuit analysis. Terminal 8 is of no interest simply because it is an unused terminal; NC stands for no connection, which means that the terminal is not connected to the amplifier circuit.

Figure 5.2 shows a widely used circuit symbol for an op amp that contains the five terminals of primary interest. Using word labels for the terminals is inconvenient in circuit diagrams, so we simplify the terminal designations in the following way. The noninverting input terminal is labeled plus (+), and the inverting input terminal is labeled minus (-). The power supply terminals, which are always drawn outside the triangle, are marked  $V^+$  and  $V^-$ . The terminal at the apex of the triangular box is always understood to be the output terminal. Figure 5.3 summarizes these simplified designations.

## 5.2 Terminal Voltages and Currents

We are now ready to introduce the terminal voltages and currents used to describe the behavior of the op amp. The voltage variables are measured from a common reference node.<sup>2</sup> Figure 5.4 shows the voltage variables with their reference polarities.

All voltages are considered as voltage rises from the common node. This convention is the same as that used in the node-voltage method of analysis. A positive supply voltage ( $V_{CC}$ ) is connected between  $V^+$  and the common node. A negative supply voltage ( $-V_{CC}$ ) is connected between  $V^-$  and the common node. The voltage between the inverting input terminal and the common node is denoted  $v_n$ . The voltage between the noninverting input terminal and the common node is designated as  $v_p$ . The voltage between the output terminal and the common node is denoted  $v_o$ .

<sup>1</sup> DIP is an abbreviation for *dual in-line package*. This means that the terminals on each side of the package are in line, and that the terminals on opposite sides of the package also line up.

<sup>2</sup> The common node is external to the op amp. It is the reference terminal of the circuit in which the op amp is embedded.



Figure 5.5 shows the current variables with their reference directions. Note that all the current reference directions are into the terminals of the operational amplifier:  $i_n$  is the current into the inverting input terminal;  $i_p$  is the current into the noninverting input terminal;  $i_o$  is the current into the output terminal;  $i_{c^+}$  is the current into the positive power supply terminal; and  $i_{c^-}$  is the current into the negative power supply terminal.

The terminal behavior of the op amp as a linear circuit element is characterized by constraints on the input voltages and the input currents. The voltage constraint is derived from the voltage transfer characteristic of the op amp integrated circuit and is pictured in Fig. 5.6.

The voltage transfer characteristic describes how the output voltage varies as a function of the input voltages; that is, how voltage is transferred from the input to the output. Note that for the op amp, the output voltage is a function of the difference between the input voltages,  $v_p - v_n$ . The equation for the voltage transfer characteristic is

$$v_o = \begin{cases} -V_{CC} & A(v_p - v_n) < -V_{CC}, \\ A(v_p - v_n) & -V_{CC} \leq A(v_p - v_n) \leq +V_{CC}, \\ +V_{CC} & A(v_p - v_n) > +V_{CC}. \end{cases} \quad (5.1)$$

We see from Fig. 5.6 and Eq. 5.1 that the op amp has three distinct regions of operation. When the magnitude of the input voltage difference ( $|v_p - v_n|$ ) is small, the op amp behaves as a linear device, as the output voltage is a linear function of the input voltages. Outside this linear region, the output of the op amp saturates, and the op amp behaves as a nonlinear device, because the output voltage is no longer a linear function of the input voltages. When it is operating linearly, the op amp's output voltage is equal to the difference in its input voltages times the multiplying constant, or **gain**,  $A$ .

When we confine the op amp to its linear operating region, a constraint is imposed on the input voltages,  $v_p$  and  $v_n$ . The constraint is based on typical numerical values for  $V_{CC}$  and  $A$  in Eq. 5.1. For most op amps, the recommended dc power supply voltages seldom exceed 20 V, and the gain,  $A$ , is rarely less than 10,000, or  $10^4$ . We see from both Fig. 5.6 and Eq. 5.1 that in the linear region, the magnitude of the input voltage difference ( $|v_p - v_n|$ ) must be less than  $20/10^4$ , or 2 mV.

Typically, node voltages in the circuits we study are much larger than 2 mV, so a voltage difference of less than 2 mV means the two voltages are essentially equal. Thus, when an op amp is constrained to its linear operating region and the node voltages are much larger than 2 mV, the constraint on the input voltages of the op amp is

$$v_p = v_n. \quad (5.2)$$

Note that Eq. 5.2 characterizes the relationship between the input voltages for an ideal op amp; that is, an op amp whose value of  $A$  is infinite.

The input voltage constraint in Eq. 5.2 is called the *virtual short* condition at the input of the op amp. It is natural to ask how the virtual short is maintained at the input of the op amp when the op amp is embedded in a circuit, thus ensuring linear operation. The answer is that a signal is fed back from the output terminal to the inverting input terminal. This configuration is known as **negative feedback** because the

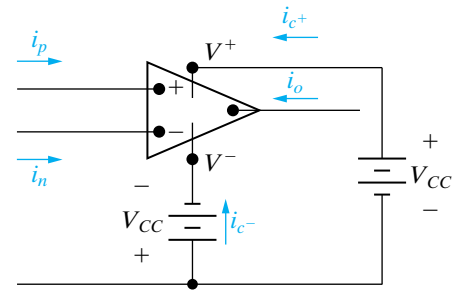


Figure 5.5 ▲ Terminal current variables.

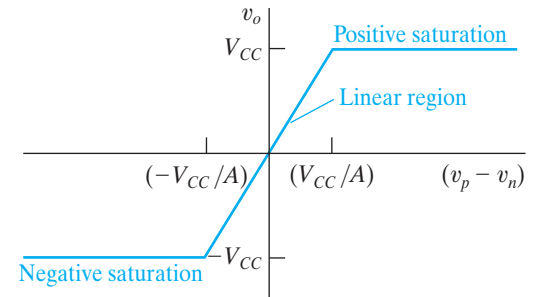


Figure 5.6 ▲ The voltage transfer characteristic of an op amp.

### ◀ Input voltage constraint for ideal op amp

signal fed back from the output subtracts from the input signal. The negative feedback causes the input voltage difference to decrease. Because the output voltage is proportional to the input voltage difference, the output voltage is also decreased, and the op amp operates in its linear region.

If a circuit containing an op amp does not provide a negative feedback path from the op amp output to the inverting input, then the op amp will normally saturate. The difference in the input signals must be extremely small to prevent saturation with no negative feedback. But even if the circuit provides a negative feedback path for the op amp, linear operation is not ensured. So how do we know whether the op amp is operating in its linear region?

The answer is, we don't! We deal with this dilemma by assuming linear operation, performing the circuit analysis, and then checking our results for contradictions. For example, suppose we assume that an op amp in a circuit is operating in its linear region, and we compute the output voltage of the op amp to be 10 V. On examining the circuit, we discover that  $V_{CC}$  is 6 V, resulting in a contradiction, because the op amp's output voltage can be no larger than  $V_{CC}$ . Thus our assumption of linear operation was invalid, and the op amp output must be saturated at 6 V.

We have identified a constraint on the input voltages that is based on the voltage transfer characteristic of the op amp integrated circuit, the assumption that the op amp is restricted to its linear operating region and to typical values for  $V_{CC}$  and  $A$ . Equation 5.2 represents the voltage constraint for an ideal op amp, that is, with a value of  $A$  that is infinite.

We now turn our attention to the constraint on the input currents. Analysis of the op amp integrated circuit reveals that the equivalent resistance seen by the input terminals of the op amp is very large, typically 1 M $\Omega$  or more. Ideally, the equivalent input resistance is infinite, resulting in the current constraint

#### Input current constraint for ideal op amp ►

$$i_p = i_n = 0. \quad (5.3)$$

Note that the current constraint is not based on assuming the op amp is confined to its linear operating region as was the voltage constraint. Together, Eqs. 5.2 and 5.3 form the constraints on terminal behavior that define our ideal op amp model.

From Kirchhoff's current law we know that the sum of the currents entering the operational amplifier is zero, or

$$i_p + i_n + i_o + i_{c^+} + i_{c^-} = 0. \quad (5.4)$$

Substituting the constraint given by Eq. 5.3 into Eq. 5.4 gives

$$i_o = -(i_{c^+} + i_{c^-}). \quad (5.5)$$

The significance of Eq. 5.5 is that, even though the current at the input terminals is negligible, there may still be appreciable current at the output terminal.

Before we start analyzing circuits containing op amps, let's further simplify the circuit symbol. When we know that the amplifier is operating within its linear region, the dc voltages  $\pm V_{CC}$  do not enter into the circuit equations.



In this case, we can remove the power supply terminals from the symbol and the dc power supplies from the circuit, as shown in Fig. 5.7. A word of caution: Because the power supply terminals have been omitted, there is a danger of inferring from the symbol that  $i_p + i_n + i_o = 0$ . We have already noted that such is not the case; that is,  $i_p + i_n + i_o + i_{c^+} + i_{c^-} = 0$ . In other words, the ideal op amp model constraint that  $i_p = i_n = 0$  does not imply that  $i_o = 0$ .

Note that the positive and negative power supply voltages do not have to be equal in magnitude. In the linear operating region,  $v_o$  must lie between the two supply voltages. For example, if  $V^+ = 15\text{ V}$  and  $V^- = -10\text{ V}$ , then  $-10\text{ V} \leq v_o \leq 15\text{ V}$ . Be aware also that the value of  $A$  is not constant under all operating conditions. For now, however, we assume that it is. A discussion of how and why the value of  $A$  can change must be delayed until after you have studied the electronic devices and components used to fabricate an amplifier.

Example 5.1 illustrates the judicious application of Eqs. 5.2 and 5.3. When we use these equations to predict the behavior of a circuit containing an op amp, in effect we are using an ideal model of the device.

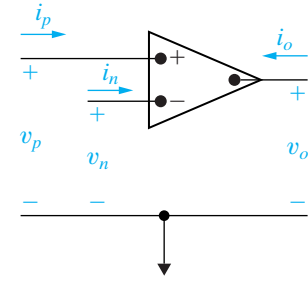


Figure 5.7 ▲ The op amp symbol with the power supply terminals removed.

### Example 5.1 Analyzing an Op Amp Circuit

The op amp in the circuit shown in Fig. 5.8 is ideal.

- Calculate  $v_o$  if  $v_a = 1\text{ V}$  and  $v_b = 0\text{ V}$ .
- Repeat (a) for  $v_a = 1\text{ V}$  and  $v_b = 2\text{ V}$ .
- If  $v_a = 1.5\text{ V}$ , specify the range of  $v_b$  that avoids amplifier saturation.

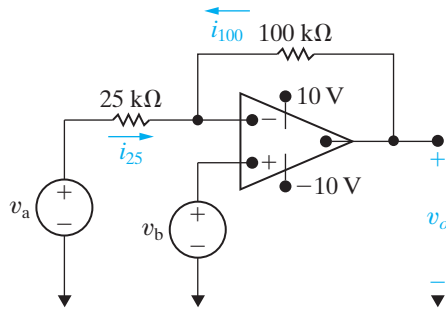


Figure 5.8 ▲ The circuit for Example 5.1.

### Solution

- Because a negative feedback path exists from the op amp's output to its inverting input through the  $100\text{ k}\Omega$  resistor, let's assume the op amp is confined to its linear operating region. We can write a node-voltage equation at the inverting input terminal. The voltage at the inverting input terminal is 0, as  $v_p = v_b = 0$  from the connected voltage source, and  $v_n = v_p$  from the voltage constraint Eq. 5.2. The node-voltage equation at  $v_n$  is thus

$$i_{25} = i_{100} = i_n.$$

From Ohm's law,

$$i_{25} = (v_a - v_n)/25 = \frac{1}{25}\text{ mA},$$

$$i_{100} = (v_o - v_n)/100 = v_o/100\text{ mA}.$$

The current constraint requires  $i_n = 0$ . Substituting the values for the three currents into the node-voltage equation, we obtain

$$\frac{1}{25} + \frac{v_o}{100} = 0.$$

Hence,  $v_o$  is  $-4\text{ V}$ . Note that because  $v_o$  lies between  $\pm 10\text{ V}$ , the op amp is in its linear region of operation.

- Using the same process as in (a), we get

$$v_p = v_b = v_n = 2\text{ V},$$

$$i_{25} = \frac{v_a - v_n}{25} = \frac{1 - 2}{25} = -\frac{1}{25}\text{ mA},$$

$$i_{100} = \frac{v_o - v_n}{100} = \frac{v_o - 2}{100}\text{ mA},$$

$$i_{25} = -i_{100}.$$

Therefore,  $v_o = 6\text{ V}$ . Again,  $v_o$  lies within  $\pm 10\text{ V}$ .

- As before,  $v_n = v_p = v_b$ , and  $i_{25} = -i_{100}$ . Because  $v_a = 1.5\text{ V}$ ,

$$\frac{1.5 - v_b}{25} = -\frac{v_o - v_b}{100}.$$

Solving for  $v_b$  as a function of  $v_o$  gives

$$v_b = \frac{1}{5}(6 + v_o).$$

Now, if the amplifier is to be within the linear region of operation,  $-10 \text{ V} \leq v_o \leq 10 \text{ V}$ .

Substituting these limits on  $v_o$  into the expression for  $v_b$ , we see that  $v_b$  is limited to

$$-0.8 \text{ V} \leq v_b \leq 3.2 \text{ V}.$$

### ASSESSMENT PROBLEM

#### Objective 1—Use voltage and current constraints in an ideal op amp

5.1 Assume that the op amp in the circuit shown is ideal.

- Calculate  $v_o$  for the following values of  $v_s$ : 0.4, 2.0, 3.5, -0.6, -1.6, and -2.4 V.
- Specify the range of  $v_s$  required to avoid amplifier saturation.

**Answer:** (a) -2, -10, -15, 3, 8, and 10 V;  
 (b)  $-2 \text{ V} \leq v_s \leq 3 \text{ V}$ .

*NOTE:* Also try Chapter Problems 5.1, 5.4, and 5.5.

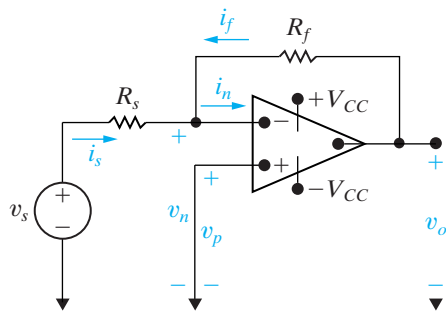
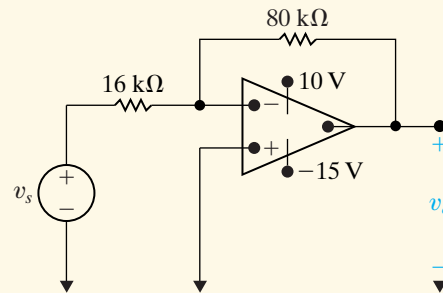


Figure 5.9 ▲ An inverting-amplifier circuit.

## 5.3 The Inverting-Amplifier Circuit

We are now ready to discuss the operation of some important op amp circuits, using Eqs. 5.2 and 5.3 to model the behavior of the device itself. Figure 5.9 shows an inverting-amplifier circuit. We assume that the op amp is operating in its linear region. Note that, in addition to the op amp, the circuit consists of two resistors ( $R_f$  and  $R_s$ ), a voltage signal source ( $v_s$ ), and a short circuit connected between the noninverting input terminal and the common node.

We now analyze this circuit, assuming an ideal op amp. The goal is to obtain an expression for the output voltage,  $v_o$ , as a function of the source voltage,  $v_s$ . We employ a single node-voltage equation at the inverting terminal of the op amp, given as

$$i_s + i_f = i_n. \tag{5.6}$$

The voltage constraint of Eq. 5.2 sets the voltage at  $v_n = 0$ , because the voltage at  $v_p = 0$ . Therefore,

$$i_s = \frac{v_s}{R_s}, \tag{5.7}$$

$$i_f = \frac{v_o}{R_f}. \tag{5.8}$$

Now we invoke the constraint stated in Eq. 5.3, namely,

$$i_n = 0. \tag{5.9}$$

Substituting Eqs. 5.7–5.9 into Eq. 5.6 yields the sought-after result:

$$v_o = \frac{-R_f}{R_s} v_s. \tag{5.10}$$

**Inverting-amplifier equation** ►

Note that the output voltage is an inverted, scaled replica of the input. The sign reversal from input to output is, of course, the reason for referring to the circuit as an *inverting* amplifier. The scaling factor, or gain, is the ratio  $R_f/R_s$ .

The result given by Eq. 5.10 is valid only if the op amp shown in the circuit in Fig. 5.9 is ideal; that is, if  $A$  is infinite and the input resistance is infinite. For a practical op amp, Eq. 5.10 is an approximation, usually a good one. (We say more about this later.) Equation 5.10 is important because it tells us that if the op amp gain  $A$  is large, we can specify the gain of the inverting amplifier with the external resistors  $R_f$  and  $R_s$ . The upper limit on the gain,  $R_f/R_s$ , is determined by the power supply voltages and the value of the signal voltage  $v_s$ . If we assume equal power supply voltages, that is,  $V^+ = -V^- = V_{CC}$ , we get

$$|v_o| \leq V_{CC}, \quad \left| \frac{R_f}{R_s} v_s \right| \leq V_{CC}, \quad \frac{R_f}{R_s} \leq \left| \frac{V_{CC}}{v_s} \right|. \quad (5.11)$$

For example, if  $V_{CC} = 15 \text{ V}$  and  $v_s = 10 \text{ mV}$ , the ratio  $R_f/R_s$  must be less than 1500.

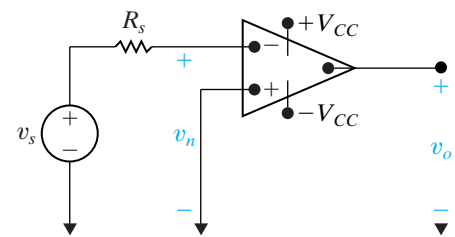
In the inverting amplifier circuit shown in Fig. 5.9, the resistor  $R_f$  provides the negative feedback connection. That is, it connects the output terminal to the inverting input terminal. If  $R_f$  is removed, the feedback path is opened and the amplifier is said to be operating *open loop*. Figure 5.10 shows the open-loop operation.

Opening the feedback path drastically changes the behavior of the circuit. First, the output voltage is now

$$v_o = -A v_n, \quad (5.12)$$

assuming as before that  $V^+ = -V^- = V_{CC}$ ; then  $|v_n| < V_{CC}/A$  for linear operation. Because the inverting input current is almost zero, the voltage drop across  $R_s$  is almost zero, and the inverting input voltage nearly equals the signal voltage,  $v_s$ ; that is,  $v_n \approx v_s$ . Hence, the op amp can operate open loop in the linear mode only if  $|v_s| < V_{CC}/A$ . If  $|v_s| > V_{CC}/A$ , the op amp simply saturates. In particular, if  $v_s < -V_{CC}/A$ , the op amp saturates at  $+V_{CC}$ , and if  $v_s > V_{CC}/A$ , the op amp saturates at  $-V_{CC}$ . Because the relationship shown in Eq. 5.12 occurs when there is no feedback path, the value of  $A$  is often called the **open-loop gain** of the op amp.

Example 5.2 uses the inverting-amplifier equation to design an inverting amplifier using realistic resistor values.



**Figure 5.10** ▲ An inverting amplifier operating open loop.

### Example 5.2 Designing an Inverting Amplifier

- Design an inverting amplifier (see Fig. 5.9) with a gain of 12. Use  $\pm 15 \text{ V}$  power supplies and an ideal op amp.
- What range of input voltages,  $v_s$ , allows the op amp in this design to remain in its linear operating region?

#### Solution

- We need to find two resistors whose ratio is 12 from the realistic resistor values listed in

Appendix H. There are lots of different possibilities, but let's choose  $R_s = 1 \text{ k}\Omega$  and  $R_f = 12 \text{ k}\Omega$ . Use the inverting-amplifier equation (Eq. 5.10) to verify the design:

$$v_o = -\frac{R_f}{R_s} v_s = -\frac{12,000}{1000} v_s = -12v_s.$$

Thus, we have an inverting-amplifier with a gain of 12, as shown in Fig. 5.11.

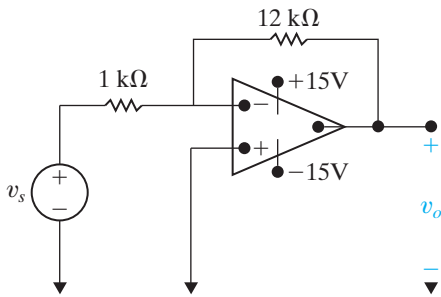


Figure 5.11 ▲ Inverting amplifier for Example 5.2.

b) Solve two different versions of the inverting-amplifier equation for  $v_s$ —first using  $v_o = +15\text{ V}$  and then using  $v_o = -15\text{ V}$ :

$$15 = -12v_s \text{ so } v_s = -1.25\text{ V};$$

$$-15 = -12v_s \text{ so } v_s = 1.25\text{ V}.$$

Thus, if the input voltage is greater than or equal to  $-1.25\text{ V}$  and less than or equal to  $+1.25\text{ V}$ , the op amp in the inverting-amplifier will remain in its linear operating region.

### ASSESSMENT PROBLEM

Objective 2—Be able to analyze simple circuits containing ideal op amps

5.2 The source voltage  $v_s$  in the circuit in Assessment Problem 5.1 is  $-640\text{ mV}$ . The  $80\text{ k}\Omega$  feedback resistor is replaced by a variable resistor  $R_x$ . What range of  $R_x$  allows the

inverting amplifier to operate in its linear region?

Answer:  $0 \leq R_x \leq 250\text{ k}\Omega$ .

NOTE: Also try Chapter Problems 5.9 and 5.11.

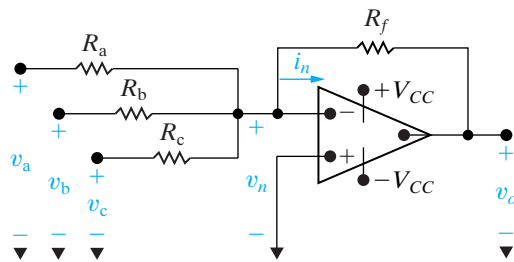


Figure 5.12 ▲ A summing amplifier.

## 5.4 The Summing-Amplifier Circuit

The output voltage of a summing amplifier is an inverted, scaled sum of the voltages applied to the input of the amplifier. Figure 5.12 shows a summing amplifier with three input voltages.

We obtain the relationship between the output voltage  $v_o$  and the three input voltages,  $v_a$ ,  $v_b$ , and  $v_c$ , by summing the currents away from the inverting input terminal:

$$\frac{v_n - v_a}{R_a} + \frac{v_n - v_b}{R_b} + \frac{v_n - v_c}{R_c} + \frac{v_n - v_o}{R_f} + i_n = 0. \quad (5.13)$$

Assuming an ideal op amp, we can use the voltage and current constraints together with the ground imposed at  $v_p$  by the circuit to see that  $v_n = v_p = 0$  and  $i_n = 0$ . This reduces Eq. 5.13 to

Inverting-summing amplifier equation ►

$$v_o = -\left(\frac{R_f}{R_a}v_a + \frac{R_f}{R_b}v_b + \frac{R_f}{R_c}v_c\right). \quad (5.14)$$

Equation 5.14 states that the output voltage is an inverted, scaled sum of the three input voltages.

If  $R_a = R_b = R_c = R_s$ , then Eq. 5.14 reduces to

$$v_o = -\frac{R_f}{R_s}(v_a + v_b + v_c). \quad (5.15)$$

Finally, if we make  $R_f = R_s$ , the output voltage is just the inverted sum of the input voltages. That is,

$$v_o = -(v_a + v_b + v_c). \quad (5.16)$$

Although we illustrated the summing amplifier with just three input signals, the number of input voltages can be increased as needed. For example, you might wish to sum 16 individually recorded audio signals to form a single audio signal. The summing amplifier configuration in Fig. 5.12 could include 16 different input resistor values so that each of the input audio tracks appears in the output signal with a different amplification factor. The summing amplifier thus plays the role of an audio mixer. As with inverting-amplifier circuits, the scaling factors in summing-amplifier circuits are determined by the external resistors  $R_f, R_a, R_b, R_c, \dots, R_n$ .

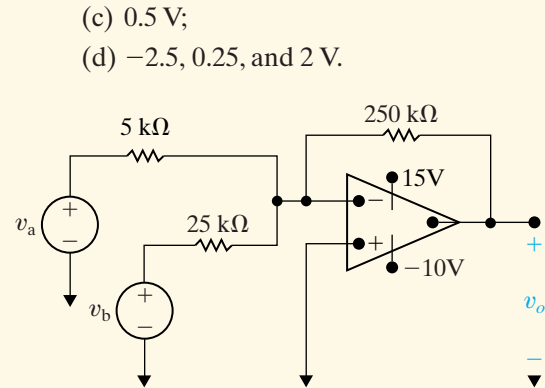
### ASSESSMENT PROBLEM

**Objective 2—Be able to analyze simple circuits containing ideal op amps**

- 5.3** a) Find  $v_o$  in the circuit shown if  $v_a = 0.1$  V and  $v_b = 0.25$  V.  
 b) If  $v_b = 0.25$  V, how large can  $v_a$  be before the op amp saturates?  
 c) If  $v_a = 0.10$  V, how large can  $v_b$  be before the op amp saturates?  
 d) Repeat (a), (b), and (c) with the polarity of  $v_b$  reversed.

**Answer:** (a)  $-7.5$  V;  
 (b)  $0.15$  V;

*NOTE:* Also try Chapter Problems 5.12–5.14.



- (c)  $0.5$  V;  
 (d)  $-2.5, 0.25,$  and  $2$  V.

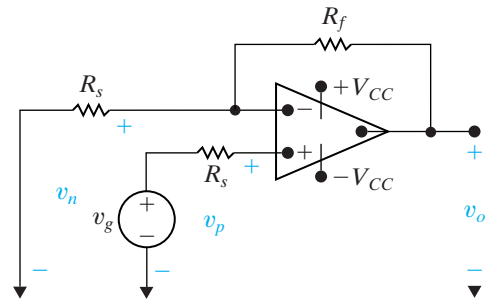
## 5.5 The Noninverting-Amplifier Circuit

Figure 5.13 depicts a noninverting-amplifier circuit. The signal source is represented by  $v_g$  in series with the resistor  $R_s$ . In deriving the expression for the output voltage as a function of the source voltage, we assume an ideal op amp operating within its linear region. Thus, as before, we use Eqs. 5.2 and 5.3 as the basis for the derivation. Because the op amp input current is zero, we can write  $v_p = v_g$  and, from Eq. 5.2,  $v_n = v_g$  as well. Now, because the input current is zero ( $i_n = i_p = 0$ ), the resistors  $R_f$  and  $R_s$  form an unloaded voltage divider across  $v_o$ . Therefore,

$$v_n = v_g = \frac{v_o R_s}{R_s + R_f}. \quad (5.17)$$

Solving Eq. 5.17 for  $v_o$  gives us the sought-after expression:

$$v_o = \frac{R_s + R_f}{R_s} v_g. \quad (5.18)$$



**Figure 5.13** ▲ A noninverting amplifier.

◀ **Noninverting-amplifier equation**

Operation in the linear region requires that

$$\frac{R_s + R_f}{R_s} < \left| \frac{V_{CC}}{v_g} \right|.$$

Note again that, because of the ideal op amp assumption, we can express the output voltage as a function of the input voltage and the external resistors—in this case,  $R_s$  and  $R_f$ .

Example 5.3 illustrates the design of a noninverting amplifier using realistic resistor values.

### Example 5.3 Designing a Noninverting Amplifier

- a) Design a noninverting amplifier (see Fig. 5.13) with a gain of 6. Assume the op amp is ideal.
- b) Suppose we wish to amplify a voltage  $v_g$ , such that  $-1.5 \text{ V} \leq v_g \leq +1.5 \text{ V}$ . What are the smallest power supply voltages that could be used with the resistors selected in part (a) and still have the op amp in this design remain in its linear operating region?

#### Solution

- a) Using the noninverting amplifier equation (Eq. 5.18),

$$v_o = \frac{R_s + R_f}{R_s} v_g = 6v_g \quad \text{so} \quad \frac{R_s + R_f}{R_s} = 6.$$

Therefore,

$$R_s + R_f = 6R_s, \quad \text{so} \quad R_f = 5R_s.$$

We want two resistors whose ratio is 5. Look at the realistic resistor values listed in Appendix H. Let's choose  $R_f = 10 \text{ k}\Omega$ , so  $R_s = 2 \text{ k}\Omega$ . But there is not a  $2 \text{ k}\Omega$  resistor in Appendix H. We can create an equivalent  $2 \text{ k}\Omega$  resistor by combining two  $1 \text{ k}\Omega$  resistors in series. We can use a third  $1 \text{ k}\Omega$  resistor as the value of the resistor  $R_g$ .

- b) Solve two different versions of the noninverting amplifier equation for  $v_o$ —first using  $v_g = +1.5 \text{ V}$  and then using  $v_g = -1.5 \text{ V}$ :

$$v_o = 6(1.5) = 9 \text{ V};$$

$$v_o = 6(-1.5) = -9 \text{ V}.$$

Thus, if we use  $\pm 9 \text{ V}$  power supplies for the noninverting amplifier designed in part (a) and  $-1.5 \text{ V} \leq v_g \leq +1.5 \text{ V}$ , the op amp will remain in its linear operating region. The circuit resulting from the analysis in parts (a) and (b) is shown in Fig. 5.14.

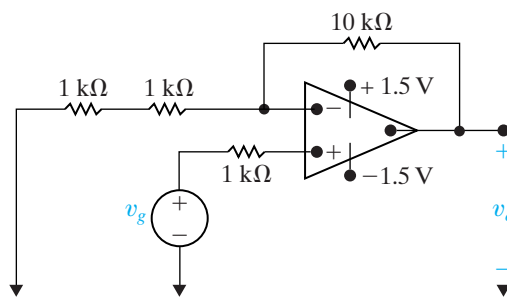


Figure 5.14 ▲ The noninverting amplifier design of Example 5.3.

## ASSESSMENT PROBLEM

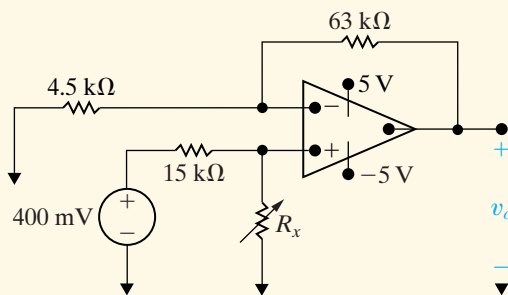
Objective 2—Be able to analyze simple circuits containing ideal op amps

- 5.4 Assume that the op amp in the circuit shown is ideal.

- a) Find the output voltage when the variable resistor is set to  $60 \text{ k}\Omega$ .
- b) How large can  $R_x$  be before the amplifier saturates?

**Answer:** (a)  $4.8 \text{ V}$ ;  
(b)  $75 \text{ k}\Omega$ .

*NOTE:* Also try Chapter Problems 5.19 and 5.20.



## 5.6 The Difference-Amplifier Circuit

The output voltage of a difference amplifier is proportional to the difference between the two input voltages. To demonstrate, we analyze the difference-amplifier circuit shown in Fig. 5.15, assuming an ideal op amp operating in its linear region. We derive the relationship between  $v_o$  and the two input voltages  $v_a$  and  $v_b$  by summing the currents away from the inverting input node:

$$\frac{v_n - v_a}{R_a} + \frac{v_n - v_o}{R_b} + i_n = 0. \quad (5.19)$$

Because the op amp is ideal, we use the voltage and current constraints to see that

$$i_n = i_p = 0, \quad (5.20)$$

$$v_n = v_p = \frac{R_d}{R_c + R_d} v_b. \quad (5.21)$$

Combining Eqs. 5.19, 5.20, and 5.21 gives the desired relationship:

$$v_o = \frac{R_d(R_a + R_b)}{R_a(R_c + R_d)} v_b - \frac{R_b}{R_a} v_a. \quad (5.22)$$

Equation 5.22 shows that the output voltage is proportional to the difference between a scaled replica of  $v_b$  and a scaled replica of  $v_a$ . In general the scaling factor applied to  $v_b$  is not the same as that applied to  $v_a$ . However, the scaling factor applied to each input voltage can be made equal by setting

$$\frac{R_a}{R_b} = \frac{R_c}{R_d}. \quad (5.23)$$

When Eq. 5.23 is satisfied, the expression for the output voltage reduces to

$$v_o = \frac{R_b}{R_a} (v_b - v_a). \quad (5.24) \quad \blacktriangleleft \text{Simplified difference-amplifier equation}$$

Equation 5.24 indicates that the output voltage can be made a scaled replica of the difference between the input voltages  $v_b$  and  $v_a$ . As in the previous ideal amplifier circuits, the scaling is controlled by the external resistors. Furthermore, the relationship between the output voltage and the input voltages is not affected by connecting a nonzero load resistance across the output of the amplifier.

Example 5.4 describes the design of a difference amplifier using realistic resistor values.

### Example 5.4 Designing a Difference Amplifier

a) Design a difference amplifier (see Fig. 5.15) that amplifies the difference between two input voltages by a gain of 8, using an ideal op amp and  $\pm 8$  V power supplies.

b) Suppose  $v_a = 1$  V in the difference amplifier designed in part (a). What range of input voltages for  $v_b$  will allow the op amp to remain in its linear operating region?

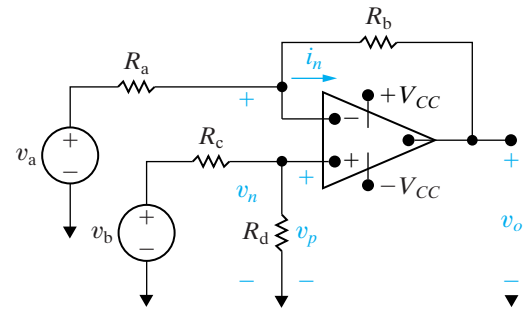


Figure 5.15 ▲ A difference amplifier.



### Solution

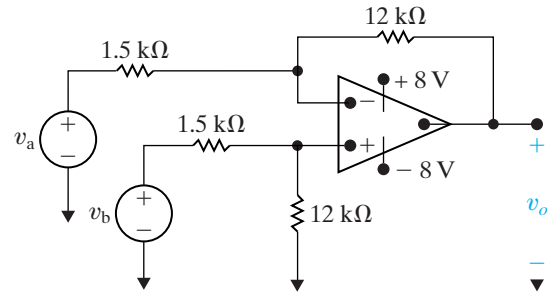
- a) Using the simplified difference-amplifier equation (Eq. 5.24),

$$v_o = \frac{R_b}{R_a}(v_b - v_a) = 8(v_b - v_a) \text{ so } \frac{R_b}{R_a} = 8.$$

We want two resistors whose ratio is 8. Look at the realistic resistor values listed in Appendix H. Let's choose  $R_b = 12 \text{ k}\Omega$ , so  $R_a = 1.5 \text{ k}\Omega$ , although there are many other possibilities. Note that the simplified difference-amplifier equation requires that

$$\frac{R_a}{R_b} = \frac{R_c}{R_d}.$$

A simple choice for  $R_c$  and  $R_d$  is  $R_c = R_a = 1.5 \text{ k}\Omega$  and  $R_d = R_b = 12 \text{ k}\Omega$ . The resulting circuit is shown in Fig. 5.16.



**Figure 5.16** ▲ The difference amplifier designed in Example 5.4.

- b) Solve two different versions of the simplified difference-amplifier equation for  $v_o$  in terms of  $v_b$ —first using  $v_o = +8 \text{ V}$  and then using  $v_o = -8 \text{ V}$ :

$$v_o = 8(v_b - 1) = 8 \text{ V} \text{ so } v_b = 2 \text{ V};$$

$$v_o = 8(v_b - 1) = -8 \text{ V} \text{ so } v_b = 0 \text{ V}.$$

Thus, if  $v_a = 1 \text{ V}$  in the difference amplifier from part (a), the op amp will remain in its linear region of operation if  $0 \text{ V} \leq v_b \leq +2 \text{ V}$ .

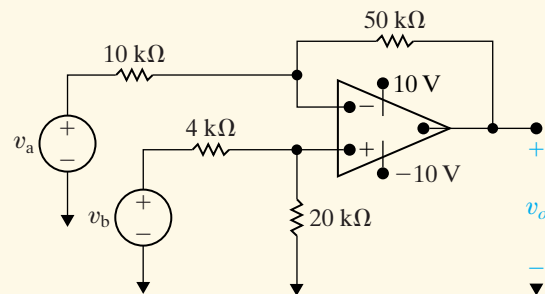
### ASSESSMENT PROBLEM

**Objective 2**—Be able to analyze simple circuits containing ideal op amps

- 5.5 a) In the difference amplifier shown,  $v_b = 4.0 \text{ V}$ . What range of values for  $v_a$  will result in linear operation?  
 b) Repeat (a) with the  $20 \text{ k}\Omega$  resistor decreased to  $8 \text{ k}\Omega$ .

**Answer:** (a)  $2 \text{ V} \leq v_a \leq 6 \text{ V}$ ;  
 (b)  $1.2 \text{ V} \leq v_a \leq 5.2 \text{ V}$ .

*NOTE:* Also try Chapter Problems 5.26, 5.27, and 5.30.



### The Difference Amplifier—Another Perspective

We can examine the behavior of a difference amplifier more closely if we redefine its inputs in terms of two other voltages. The first is the **differential mode** input, which is the difference between the two input voltages in Fig. 5.15:

$$v_{dm} = v_b - v_a. \quad (5.25)$$

The second is the **common mode** input, which is the average of the two input voltages in Fig. 5.15:

$$v_{cm} = (v_a + v_b)/2. \quad (5.26)$$

Using Eqs. 5.25 and 5.26, we can now represent the original input voltages,  $v_a$  and  $v_b$ , in terms of the differential mode and common mode voltages,  $v_{dm}$  and  $v_{cm}$ :

$$v_a = v_{cm} - \frac{1}{2}v_{dm}, \quad (5.27)$$

$$v_b = v_{cm} + \frac{1}{2}v_{dm}. \quad (5.28)$$

Substituting Eqs. 5.27 and 5.28 into Eq. 5.22 gives the output of the difference amplifier in terms of the differential mode and common mode voltages:

$$v_o = \left[ \frac{R_a R_d - R_b R_c}{R_a (R_c + R_d)} \right] v_{cm} + \left[ \frac{R_d (R_a + R_b) + R_b (R_c + R_d)}{2 R_a (R_c + R_d)} \right] v_{dm} \quad (5.29)$$

$$= A_{cm} v_{cm} + A_{dm} v_{dm}, \quad (5.30)$$

where  $A_{cm}$  is the common mode gain and  $A_{dm}$  is the differential mode gain. Now, substitute  $R_c = R_a$  and  $R_d = R_b$ , which are possible values for  $R_c$  and  $R_d$  that satisfy Eq. 5.23, into Eq. 5.29:

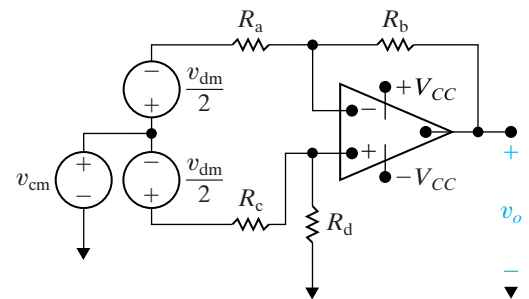
$$v_o = (0)v_{cm} + \left( \frac{R_b}{R_a} \right) v_{dm}. \quad (5.31)$$

Thus, an ideal difference amplifier has  $A_{cm} = 0$ , amplifies only the differential mode portion of the input voltage, and eliminates the common mode portion of the input voltage. Figure 5.17 shows a difference-amplifier circuit with differential mode and common mode input voltages in place of  $v_a$  and  $v_b$ .

Equation 5.30 provides an important perspective on the function of the difference amplifier, since in many applications it is the differential mode signal that contains the information of interest, whereas the common mode signal is the noise found in all electric signals. For example, an electrocardiograph electrode measures the voltages produced by your body to regulate your heartbeat. These voltages have very small magnitudes compared with the electrical noise that the electrode picks up from sources such as lights and electrical equipment. The noise appears as the common mode portion of the measured voltage, whereas the heart rate voltages comprise the differential mode portion. Thus an ideal difference amplifier would amplify only the voltage of interest and would suppress the noise.

### Measuring Difference-Amplifier Performance— The Common Mode Rejection Ratio

An ideal difference amplifier has zero common mode gain and nonzero (and usually large) differential mode gain. Two factors have an influence on the ideal common mode gain—resistance mismatches (that is, Eq. [5.23] is not satisfied) or a nonideal op amp (that is, Eq. [5.20] is not satisfied). We focus here on the effect of resistance mismatches on the performance of a difference amplifier.



**Figure 5.17** ▲ A difference amplifier with common mode and differential mode input voltages.

Suppose that resistor values are chosen that do not precisely satisfy Eq. 5.23. Instead, the relationship among the resistors  $R_a$ ,  $R_b$ ,  $R_c$ , and  $R_d$  is

$$\frac{R_a}{R_b} = (1 - \epsilon) \frac{R_c}{R_d},$$

so

$$R_a = (1 - \epsilon)R_c \quad \text{and} \quad R_b = R_d, \quad (5.32)$$

or

$$R_d = (1 - \epsilon)R_b \quad \text{and} \quad R_a = R_c, \quad (5.33)$$

where  $\epsilon$  is a very small number. We can see the effect of this resistance mismatch on the common mode gain of the difference amplifier by substituting Eq. 5.33 into Eq. 5.29 and simplifying the expression for  $A_{cm}$ :

$$A_{cm} = \frac{R_a(1 - \epsilon)R_b - R_aR_b}{R_a[R_a + (1 - \epsilon)R_b]} \quad (5.34)$$

$$= \frac{-\epsilon R_b}{R_a + (1 - \epsilon)R_b} \quad (5.35)$$

$$\approx \frac{-\epsilon R_b}{R_a + R_b}. \quad (5.36)$$

We can make the approximation to give Eq. 5.36 because  $\epsilon$  is very small, and therefore  $(1 - \epsilon)$  is approximately 1 in the denominator of Eq. 5.35. Note that, when the resistors in the difference amplifier satisfy Eq. 5.23,  $\epsilon = 0$  and Eq. 5.36 gives  $A_{cm} = 0$ .

Now calculate the effect of the resistance mismatch on the differential mode gain by substituting Eq. 5.33 into Eq. 5.29 and simplifying the expression for  $A_{dm}$ :

$$A_{dm} = \frac{(1 - \epsilon)R_b(R_a + R_b) + R_b[R_a + (1 - \epsilon)R_b]}{2R_a[R_a + (1 - \epsilon)R_b]} \quad (5.37)$$

$$= \frac{R_b}{R_a} \left[ 1 - \frac{(\epsilon/2)R_a}{R_a + (1 - \epsilon)R_b} \right] \quad (5.38)$$

$$\approx \frac{R_b}{R_a} \left[ 1 - \frac{(\epsilon/2)R_a}{R_a + R_b} \right]. \quad (5.39)$$

We use the same rationale for the approximation in Eq. 5.39 as in the computation of  $A_{cm}$ . When the resistors in the difference amplifier satisfy Eq. 5.23,  $\epsilon = 0$  and Eq. 5.39 gives  $A_{dm} = R_b/R_a$ .

The **common mode rejection ratio (CMRR)** can be used to measure how nearly ideal a difference amplifier is. It is defined as the ratio of the differential mode gain to the common mode gain:

$$\text{CMRR} = \left| \frac{A_{dm}}{A_{cm}} \right|. \quad (5.40)$$

The higher the CMRR, the more nearly ideal the difference amplifier. We can see the effect of resistance mismatch on the CMRR by substituting Eqs. 5.36 and 5.39 into Eq. 5.40:

$$\text{CMRR} \approx \left| \frac{\frac{R_b}{R_a} [1 - (R_a \epsilon / 2) / (R_a + R_b)]}{-\epsilon R_b / (R_a + R_b)} \right| \quad (5.41)$$

$$\approx \left| \frac{R_a (1 - \epsilon / 2) + R_b}{-\epsilon R_a} \right| \quad (5.42)$$

$$\approx \left| \frac{1 + R_b / R_a}{-\epsilon} \right|. \quad (5.43)$$

From Eq. 5.43, if the resistors in the difference amplifier are matched,  $\epsilon = 0$  and  $\text{CMRR} = \infty$ . Even if the resistors are mismatched, we can minimize the impact of the mismatch by making the differential mode gain ( $R_b/R_a$ ) very large, thereby making the CMRR large.

We said at the outset that another reason for nonzero common mode gain is a nonideal op amp. Note that the op amp is itself a difference amplifier, because in the linear operating region, its output is proportional to the difference of its inputs; that is,  $v_o = A(v_p - v_n)$ . The output of a nonideal op amp is not strictly proportional to the difference between the inputs (the differential mode input) but also is comprised of a common mode signal. Internal mismatches in the components of the integrated circuit make the behavior of the op amp nonideal, in the same way that the resistor mismatches in the difference-amplifier circuit make its behavior nonideal. Even though a discussion of nonideal op amps is beyond the scope of this text, you may note that the CMRR is often used in assessing how nearly ideal an op amp's behavior is. In fact, it is one of the main ways of rating op amps in practice.

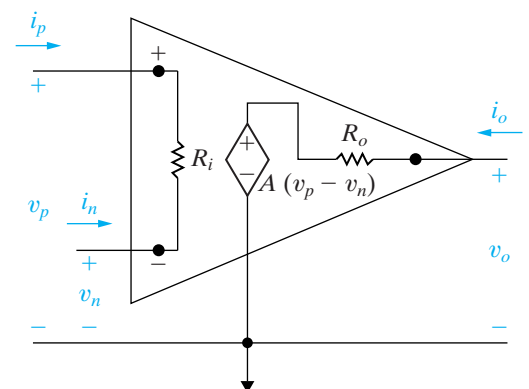
*NOTE: Assess your understanding of this material by trying Chapter Problems 5.33 and 5.34.*

## 5.7 A More Realistic Model for the Operational Amplifier

We now consider a more realistic model that predicts the performance of an op amp in its linear region of operation. Such a model includes three modifications to the ideal op amp: (1) a finite input resistance,  $R_i$ ; (2) a finite open-loop gain,  $A$ ; and (3) a nonzero output resistance,  $R_o$ . The circuit shown in Fig. 5.18 illustrates the more realistic model.

Whenever we use the equivalent circuit shown in Fig. 5.18, we disregard the assumptions that  $v_n = v_p$  (Eq. 5.2) and  $i_n = i_p = 0$  (Eq. 5.3). Furthermore, Eq. 5.1 is no longer valid because of the presence of the nonzero output resistance,  $R_o$ . Another way to understand the circuit shown in Fig. 5.18 is to reverse our thought process. That is, we can see that the circuit reduces to the ideal model when  $R_i \rightarrow \infty$ ,  $A \rightarrow \infty$ , and  $R_o \rightarrow 0$ . For the  $\mu A741$  op amp, the typical values of  $R_i$ ,  $A$ , and  $R_o$  are 2 M $\Omega$ ,  $10^5$ , and 75  $\Omega$ , respectively.

Although the presence of  $R_i$  and  $R_o$  makes the analysis of circuits containing op amps more cumbersome, such analysis remains straightforward.



**Figure 5.18** ▲ An equivalent circuit for an operational amplifier.

To illustrate, we analyze both an inverting and a noninverting amplifier, using the equivalent circuit shown in Fig. 5.18. We begin with the inverting amplifier.

### Analysis of an Inverting-Amplifier Circuit Using the More Realistic Op Amp Model

If we use the op amp circuit shown in Fig. 5.18, the circuit for the inverting amplifier is the one depicted in Fig. 5.19. As before, our goal is to express the output voltage,  $v_o$ , as a function of the source voltage,  $v_s$ . We obtain the desired expression by writing the two node-voltage equations that describe the circuit and then solving the resulting set of equations for  $v_o$ . In Fig. 5.19, the two nodes are labeled a and b. Also note that  $v_p = 0$  by virtue of the external short-circuit connection at the noninverting input terminal. The two node-voltage equations are as follows:

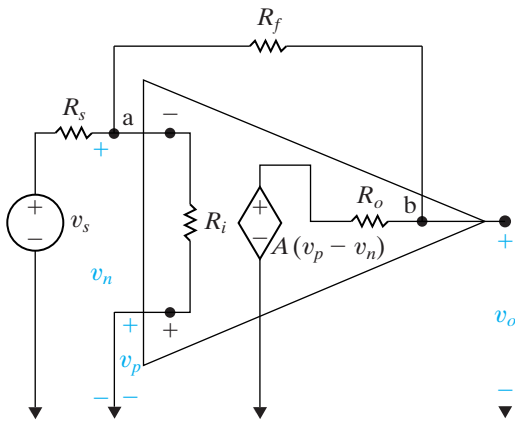


Figure 5.19 ▲ An inverting-amplifier circuit.

$$\text{node a: } \frac{v_n - v_s}{R_s} + \frac{v_n}{R_i} + \frac{v_n - v_o}{R_f} = 0, \quad (5.44)$$

$$\text{node b: } \frac{v_o - v_n}{R_f} + \frac{v_o - A(-v_n)}{R_o} = 0. \quad (5.45)$$

We rearrange Eqs. 5.44 and 5.45 so that the solution for  $v_o$  by Cramer's method becomes apparent:

$$\left( \frac{1}{R_s} + \frac{1}{R_i} + \frac{1}{R_f} \right) v_n - \frac{1}{R_f} v_o = \frac{1}{R_s} v_s, \quad (5.46)$$

$$\left( \frac{A}{R_o} - \frac{1}{R_f} \right) v_n + \left( \frac{1}{R_f} + \frac{1}{R_o} \right) v_o = 0. \quad (5.47)$$

Solving for  $v_o$  yields

$$v_o = \frac{-A + (R_o/R_f)}{\frac{R_s}{R_f} \left( 1 + A + \frac{R_o}{R_i} \right) + \left( \frac{R_s}{R_i} + 1 \right) + \frac{R_o}{R_f}} v_s. \quad (5.48)$$

Note that Eq. 5.48 reduces to Eq. 5.10 as  $R_o \rightarrow 0$ ,  $R_i \rightarrow \infty$ , and  $A \rightarrow \infty$ .

If the inverting amplifier shown in Fig. 5.19 were loaded at its output terminals with a load resistance of  $R_L$  ohms, the relationship between  $v_o$  and  $v_s$  would become

$$v_o = \frac{-A + (R_o/R_f)}{\frac{R_s}{R_f} \left( 1 + A + \frac{R_o}{R_i} + \frac{R_o}{R_L} \right) + \left( 1 + \frac{R_o}{R_L} \right) \left( 1 + \frac{R_s}{R_i} \right) + \frac{R_o}{R_f}} v_s. \quad (5.49)$$

### Analysis of a Noninverting-Amplifier Circuit Using the More Realistic Op Amp Model

When we use the equivalent circuit shown in Fig. 5.18 to analyze a noninverting amplifier, we obtain the circuit depicted in Fig. 5.20. Here, the voltage source  $v_g$ , in series with the resistance  $R_g$ , represents the signal source. The resistor  $R_L$  denotes the load on the amplifier. Our analysis

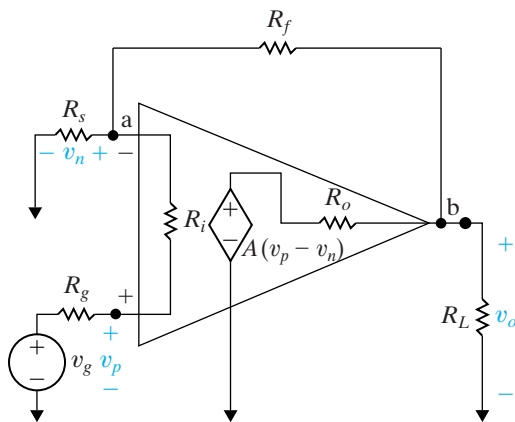


Figure 5.20 ▲ A noninverting-amplifier circuit.

consists of deriving an expression for  $v_o$  as a function of  $v_g$ . We do so by writing the node-voltage equations at nodes a and b. At node a,

$$\frac{v_n}{R_s} + \frac{v_n - v_g}{R_g + R_i} + \frac{v_n - v_o}{R_f} = 0, \quad (5.50)$$

and at node b,

$$\frac{v_o - v_n}{R_f} + \frac{v_o}{R_L} + \frac{v_o - A(v_p - v_n)}{R_o} = 0. \quad (5.51)$$

Because the current in  $R_g$  is the same as in  $R_i$ , we have

$$\frac{v_p - v_g}{R_g} = \frac{v_n - v_g}{R_i + R_g}. \quad (5.52)$$

We use Eq. 5.52 to eliminate  $v_p$  from Eq. 5.51, giving a pair of equations involving the unknown voltages  $v_n$  and  $v_o$ . This algebraic manipulation leads to

$$v_n \left( \frac{1}{R_s} + \frac{1}{R_g + R_i} + \frac{1}{R_f} \right) - v_o \left( \frac{1}{R_f} \right) = v_g \left( \frac{1}{R_g + R_i} \right), \quad (5.53)$$

$$\begin{aligned} & v_n \left[ \frac{AR_i}{R_o(R_i + R_g)} - \frac{1}{R_f} \right] + v_o \left( \frac{1}{R_f} + \frac{1}{R_o} + \frac{1}{R_L} \right) \\ &= v_g \left[ \frac{AR_i}{R_o(R_i + R_g)} \right]. \end{aligned} \quad (5.54)$$

Solving for  $v_o$  yields

$$v_o = \frac{[(R_f + R_s) + (R_s R_o / AR_i)]v_g}{R_s + \frac{R_o}{A}(1 + K_r) + \frac{R_f R_s + (R_f + R_s)(R_i + R_g)}{AR_i}}, \quad (5.55)$$

where

$$K_r = \frac{R_s + R_g}{R_i} + \frac{R_f + R_s}{R_L} + \frac{R_f R_s + R_f R_g + R_g R_s}{R_i R_L}.$$

Note that Eq. 5.55 reduces to Eq. 5.18 when  $R_o \rightarrow 0$ ,  $A \rightarrow \infty$ , and  $R_i \rightarrow \infty$ . For the unloaded ( $R_L = \infty$ ) noninverting amplifier, Eq. 5.55 simplifies to

$$v_o = \frac{[(R_f + R_s) + R_s R_o / AR_i]v_g}{R_s + \frac{R_o}{A} \left( 1 + \frac{R_s + R_g}{R_i} \right) + \frac{1}{AR_i} [R_f R_s + (R_f + R_s)(R_i + R_g)]}. \quad (5.56)$$

Note that, in the derivation of Eq. 5.56 from Eq. 5.55,  $K_r$  reduces to  $(R_s + R_g)/R_i$ .

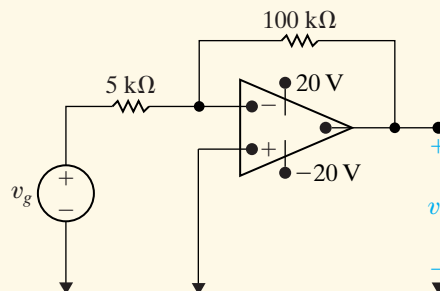
## ASSESSMENT PROBLEM

### Objective 3—Understand the more realistic model for an op amp

**5.6** The inverting amplifier in the circuit shown has an input resistance of  $500\text{ k}\Omega$ , an output resistance of  $5\text{ k}\Omega$ , and an open-loop gain of  $300,000$ . Assume that the amplifier is operating in its linear region.

- Calculate the voltage gain ( $v_o/v_g$ ) of the amplifier.
- Calculate the value of  $v_n$  in microvolts when  $v_g = 1\text{ V}$ .
- Calculate the resistance seen by the signal source ( $v_g$ ).
- Repeat (a)–(c) using the ideal model for the op amp.

**Answer:** (a)  $-19.9985$ ;  
 (b)  $69.995\ \mu\text{V}$ ;  
 (c)  $5000.35\ \Omega$ ;  
 (d)  $-20,0\ \mu\text{V}, 5\text{ k}\Omega$ .



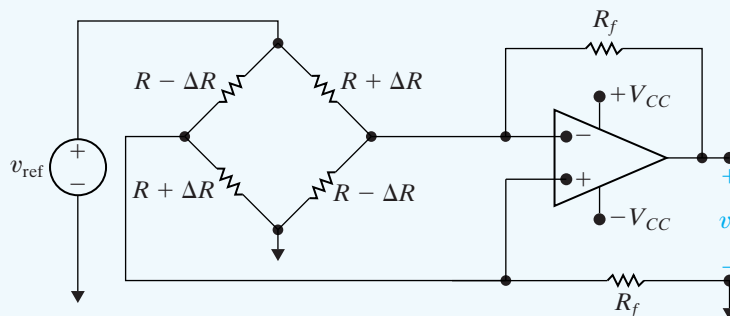
*NOTE:* Also try Chapter Problems 5.44 and 5.48.

## Practical Perspective

### Strain Gages

Changes in the shape of elastic solids are of great importance to engineers who design structures that twist, stretch, or bend when subjected to external forces. An aircraft frame is a prime example of a structure in which engineers must take into consideration elastic strain. The intelligent application of strain gages requires information about the physical structure of the gage, methods of bonding the gage to the surface of the structure, and the orientation of the gage relative to the forces exerted on the structure. Our purpose here is to point out that strain gage measurements are important in engineering applications, and a knowledge of electric circuits is germane to their proper use.

The circuit shown in Fig. 5.21 provides one way to measure the change in resistance experienced by strain gages in applications like the one



**Figure 5.21** ▲ An op amp circuit used for measuring the change in strain gage resistance.

described in the beginning of this chapter. As we will see, this circuit is the familiar difference amplifier, with the strain gage bridge providing the two voltages whose difference is amplified. The pair of strain gages that are lengthened once the bar is bent have the values  $R + \Delta R$  in the bridge



feeding the difference amplifier, whereas the pair of strain gages that are shortened have the values  $R - \Delta R$ . We will analyze this circuit to discover the relationship between the output voltage,  $v_o$  and the change in resistance,  $\Delta R$  experienced by the strain gages.

To begin, assume that the op amp is ideal. Writing the KCL equations at the inverting and noninverting input terminals of the op amp we see

$$\frac{v_{\text{ref}} - v_n}{R + \Delta R} = \frac{v_n}{R - \Delta R} + \frac{v_n - v_o}{R_f}, \quad (5.57)$$

$$\frac{v_{\text{ref}} - v_p}{R - \Delta R} = \frac{v_p}{R + \Delta R} + \frac{v_p}{R_f}. \quad (5.58)$$

Now rearrange Eq. 5.58 to get an expression for the voltage at the noninverting terminal of the op amp:

$$v_p = \frac{v_{\text{ref}}}{(R - \Delta R) \left( \frac{1}{R + \Delta R} + \frac{1}{R - \Delta R} + \frac{1}{R_f} \right)}. \quad (5.59)$$

As usual, we will assume that the op amp is operating in its linear region, so  $v_p = v_n$  and the expression for  $v_p$  in Eq. 5.59 must also be the expression for  $v_n$ . We can thus substitute the right-hand side of Eq. 5.59 in place of  $v_n$  in Eq. 5.57 and solve for  $v_o$ . After some algebraic manipulation,

$$v_o = \frac{R_f(2\Delta R)}{R^2 - (\Delta R)^2} v_{\text{ref}}. \quad (5.60)$$

Because the change in resistance experienced by strain gages is very small,  $(\Delta R)^2 \ll R^2$ , so  $R^2 - (\Delta R)^2 \approx R^2$  and Eq. 5.60 becomes

$$v_o \approx \frac{R_f}{R} 2\delta v_{\text{ref}}, \quad (5.61)$$

where  $\delta = \Delta R/R$ .

*NOTE: Assess your understanding of this Practical Perspective by trying Chapter Problem 5.49.*

## Summary

- The equation that defines the voltage transfer characteristic of an ideal op amp is

$$v_o = \begin{cases} -V_{CC}, & A(v_p - v_n) < -V_{CC}, \\ A(v_p - v_n), & -V_{CC} \leq A(v_p - v_n) \leq +V_{CC}, \\ +V_{CC}, & A(v_p - v_n) > +V_{CC}, \end{cases}$$

where  $A$  is a proportionality constant known as the open-loop gain, and  $V_{CC}$  represents the power supply voltages. (See page 147.)

- A feedback path between an op amp's output and its inverting input can constrain the op amp to its linear operating region where  $v_o = A(v_p - v_n)$ . (See page 147.)
- A voltage constraint exists when the op amp is confined to its linear operating region due to typical values of  $V_{CC}$  and  $A$ . If the ideal modeling assumptions are made—meaning  $A$  is assumed to be infinite—the ideal op amp model is characterized by the voltage constraint

$$v_p = v_n.$$

(See page 147.)

- A current constraint further characterizes the ideal op amp model, because the ideal input resistance of the op amp integrated circuit is infinite. This current constraint is given by

$$i_p = i_n = 0.$$

(See page 148.)

- We considered both a simple, ideal op amp model and a more realistic model in this chapter. The differences between the two models are as follows:

Simplified Model	More Realistic Model
Infinite input resistance	Finite input resistance
Infinite open-loop gain	Finite open-loop gain
Zero output resistance	Nonzero output resistance

(See page 159.)

- An inverting amplifier is an op amp circuit producing an output voltage that is an inverted, scaled replica of the input. (See page 150.)

- A summing amplifier is an op amp circuit producing an output voltage that is a scaled sum of the input voltages. (See page 152.)

- A noninverting amplifier is an op amp circuit producing an output voltage that is a scaled replica of the input voltage. (See page 153.)

- A difference amplifier is an op amp circuit producing an output voltage that is a scaled replica of the input voltage difference. (See page 155.)

- The two voltage inputs to a difference amplifier can be used to calculate the common mode and difference mode voltage inputs,  $v_{cm}$  and  $v_{dm}$ . The output from the difference amplifier can be written in the form

$$v_o = A_{cm}v_{cm} + A_{dm}v_{dm},$$

where  $A_{cm}$  is the common mode gain, and  $A_{dm}$  is the differential mode gain. (See page 157.)

- In an ideal difference amplifier,  $A_{cm} = 0$ . To measure how nearly ideal a difference amplifier is, we use the common mode rejection ratio:

$$CMRR = \left| \frac{A_{dm}}{A_{cm}} \right|.$$

An ideal difference amplifier has an infinite CMRR. (See page 159.)

## Problems

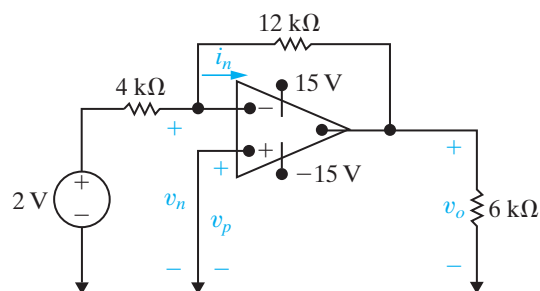
### Sections 5.1–5.2

**5.1** The op amp in the circuit in Fig. P5.1 is ideal.

PSPICE  
MULTISIM

- Label the five op amp terminals with their names.
- What ideal op amp constraint determines the value of  $i_n$ ? What is this value?
- What ideal op amp constraint determines the value of  $(v_p - v_n)$ ? What is this value?
- Calculate  $v_o$ .

Figure P5.1

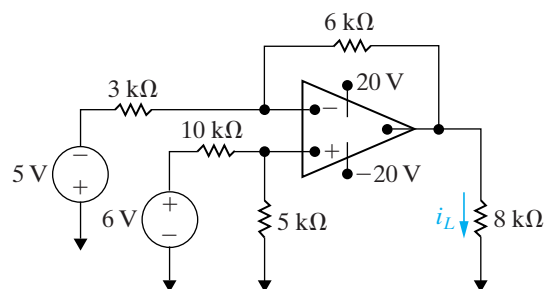


- 5.2**
- Replace the 2 V source in the circuit in Fig. P5.1 and calculate  $v_o$  for each of the following source values:  $-6$  V,  $-3.5$  V,  $-1.25$  V,  $2.4$  V,  $4.5$  V,  $5.4$  V.
  - Specify the range of voltage source values that will not cause the op amp to saturate.

**5.3** Find  $i_L$  (in milliamperes) in the circuit in Fig. P5.3.

PSPICE  
MULTISIM

Figure P5.3



**5.4** The op amp in the circuit in Fig. P5.4 is ideal.

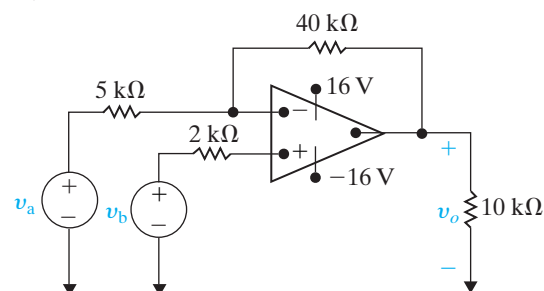
PSPICE  
MULTISIM

- Calculate  $v_o$  if  $v_a = 1.5$  V and  $v_b = 0$  V.
- Calculate  $v_o$  if  $v_a = -0.5$  V and  $v_b = 0$  V.
- Calculate  $v_o$  if  $v_a = 1$  V and  $v_b = 2.5$  V.
- Calculate  $v_o$  if  $v_a = 2.5$  V and  $v_b = 1$  V.

e) Calculate  $v_o$  if  $v_a = 2.5$  V and  $v_b = 0$  V.

f) If  $v_b = 2$  V, specify the range of  $v_a$  such that the amplifier does not saturate.

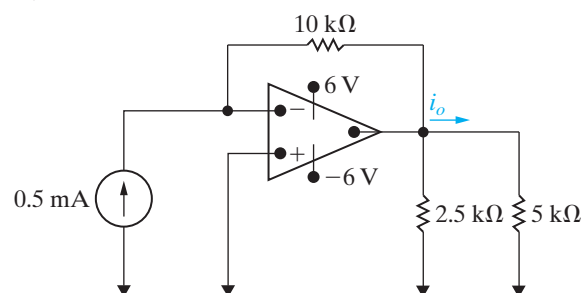
Figure P5.4



**5.5** Find  $i_o$  in the circuit in Fig. P5.5 if the op amp is ideal.

PSPICE  
MULTISIM

Figure P5.5

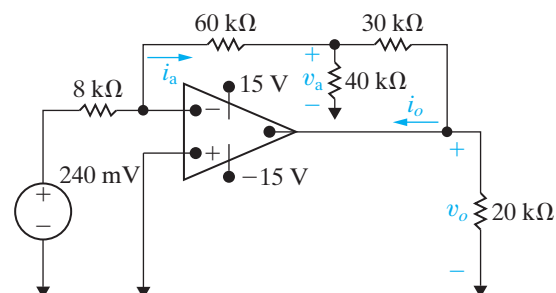


**5.6** The op amp in the circuit in Fig. P5.6 is ideal. Calculate the following:

PSPICE  
MULTISIM

- $i_a$
- $v_a$
- $v_o$
- $i_o$

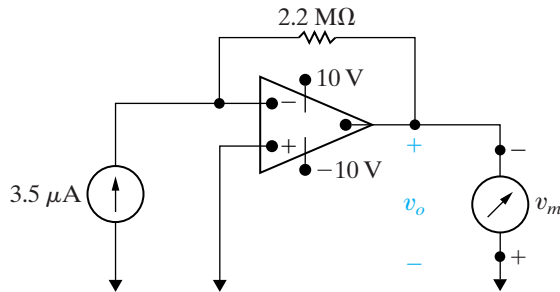
Figure P5.6



**5.7** A voltmeter with a full-scale reading of 10 V is used to measure the output voltage in the circuit in Fig. P5.7. What is the reading of the voltmeter? Assume the op amp is ideal.

PSPICE  
MULTISIM

Figure P5.7



**Section 5.3**

- 5.8** a) Design an inverting amplifier with a gain of 4. Use an ideal op amp, a 30 kΩ resistor in the feedback path, and ±12 V power supplies.  
 b) Using your design from part (a), determine the range of input voltages that will keep the op amp in its linear operating region.  
 c) Suppose you wish to amplify a 2 V signal, using your design from part (a) with a variable feedback resistor. What is the largest value of feedback resistance that keeps the op amp in its linear operation region? Using this resistor value, what is the new gain of the inverting amplifier?

**5.9** a) Design an inverting amplifier using an ideal op amp that has a gain of 2.5. Use a set of identical resistors from Appendix H.

DESIGN  
PROBLEM

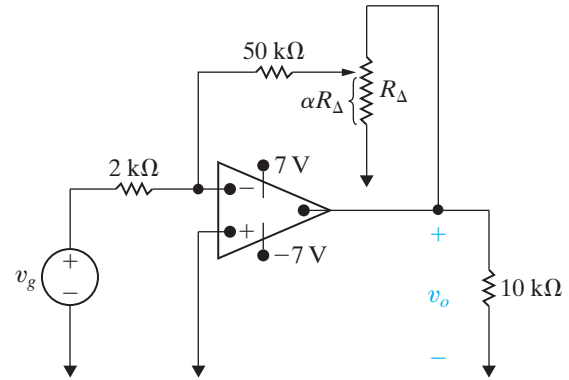
- b) If you wish to amplify signals between -2 V and +3 V using the circuit you designed in part (a), what are the smallest power supply voltages you can use?

**5.10** a) The op amp in the circuit shown in Fig. P5.10 is ideal. The adjustable resistor  $R_\Delta$  has a maximum value of 100 kΩ, and  $\alpha$  is restricted to the range of  $0.2 \leq \alpha \leq 1$ . Calculate the range of  $v_o$  if  $v_g = 40$  mV.

PSPICE  
MULTISIM

- b) If  $\alpha$  is not restricted, at what value of  $\alpha$  will the op amp saturate?

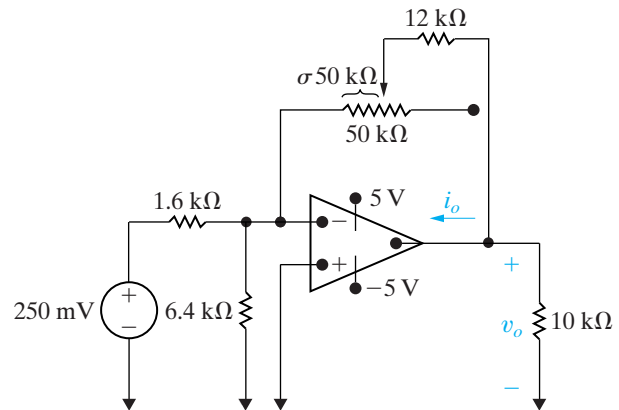
Figure P5.10



- 5.11** The op amp in the circuit in Fig. P5.11 is ideal.
- a) Find the range of values for  $\sigma$  in which the op amp does not saturate.  
 b) Find  $i_o$  (in microamperes) when  $\sigma = 0.272$ .

PSPICE  
MULTISIM

Figure P5.11



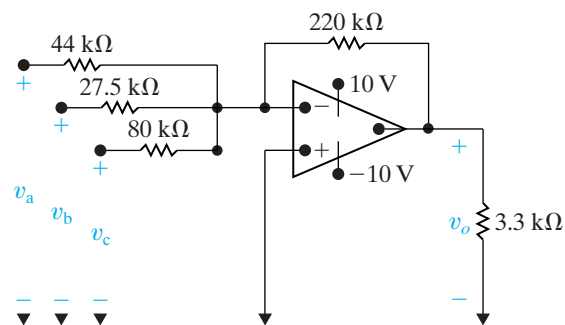
**Section 5.4**

**5.12** The op amp in Fig. P5.12 is ideal.

PSPICE  
MULTISIM

- a) What circuit configuration is shown in this figure?  
 b) Find  $v_o$  if  $v_a = 1$  V,  $v_b = 1.5$  V, and  $v_c = -4$  V.  
 c) The voltages  $v_a$  and  $v_c$  remain at 1 V and -4 V, respectively. What are the limits on  $v_b$  if the op amp operates within its linear region?

Figure P5.12

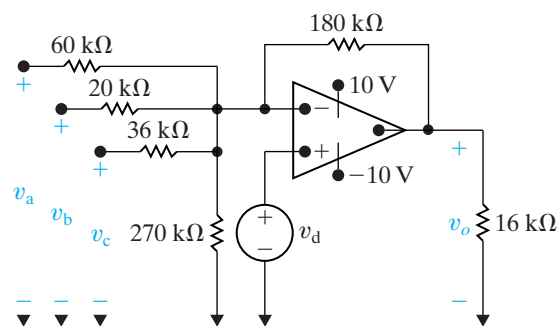


**5.13** Refer to the circuit in Fig. 5.12, where the op amp is assumed to be ideal. Given that  $R_a = 4 \text{ k}\Omega$ ,  $R_b = 5 \text{ k}\Omega$ ,  $R_c = 20 \text{ k}\Omega$ ,  $v_a = 200 \text{ mV}$ ,  $v_b = 150 \text{ mV}$ ,  $v_c = 400 \text{ mV}$ , and  $V_{CC} = \pm 6 \text{ V}$ , specify the range of  $R_f$  for which the op amp operates within its linear region.

**5.14** a) The op amp in Fig. P5.14 is ideal. Find  $v_o$  if  $v_a = 3 \text{ V}$ ,  $v_b = 9 \text{ V}$ ,  $v_c = 5 \text{ V}$ , and  $v_d = 6 \text{ V}$ .

b) Assume  $v_a$ ,  $v_b$ , and  $v_d$  retain their values as given in (a). Specify the range of  $v_c$  such that the op amp operates within its linear region.

Figure P5.14



**5.15** The  $180 \text{ k}\Omega$  feedback resistor in the circuit in Fig. P5.14 is replaced by a variable resistor  $R_f$ . The voltages  $v_a - v_d$  have the same values as given in Problem 5.14(a).

- What value of  $R_f$  will cause the op amp to saturate? Note that  $0 \leq R_f \leq \infty$ .
- When  $R_f$  has the value found in (a), what is the current (in microamperes) into the output terminal of the op amp?

**5.16** a) Design an inverting-summing amplifier using a  $120 \text{ k}\Omega$  resistor in the feedback path so that

$$v_o = -(8v_a + 5v_b + 12v_c).$$

Use  $\pm 15 \text{ V}$  power supplies.

b) Suppose  $v_a = 2 \text{ V}$  and  $v_c = -1 \text{ V}$ . What range of values for  $v_b$  will keep the op amp in its linear operating region?

**5.17** Design an inverting-summing amplifier so that

$$v_o = -(8v_a + 4v_b + 10v_c + 6v_d).$$

DESIGN  
PROBLEM  
PSPICE  
MULTISIM

Start by choosing a feedback resistor ( $R_f$ ) from Appendix H. Then choose single resistors from Appendix H or construct resistor networks from resistors in Appendix H to satisfy the design values for  $R_a$ ,  $R_b$ ,  $R_c$ , and  $R_d$ . Draw your final circuit diagram.

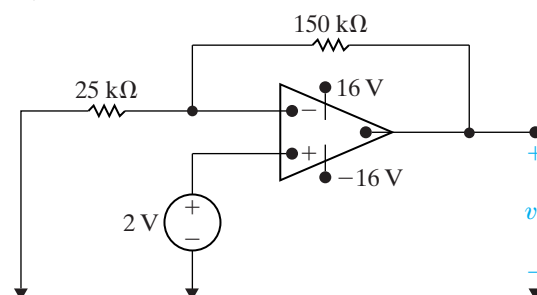
### Section 5.5

**5.18** The op amp in the circuit of Fig. P5.18 is ideal.

PSPICE  
MULTISIM

- What op amp circuit configuration is this?
- Calculate  $v_o$ .

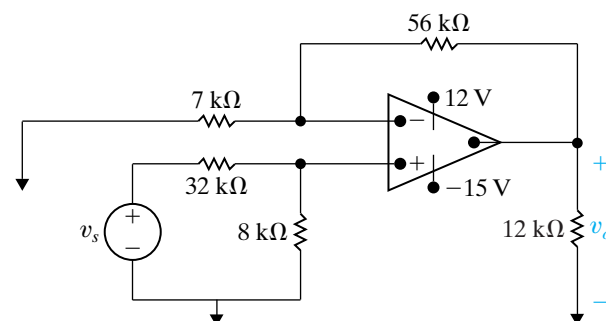
Figure P5.18



**5.19** The op amp in the circuit of Fig. P5.19 is ideal.

- What op amp circuit configuration is this?
- Find  $v_o$  in terms of  $v_s$ .
- Find the range of values for  $v_s$  such that  $v_o$  does not saturate and the op amp remains in its linear region of operation.

Figure P5.19



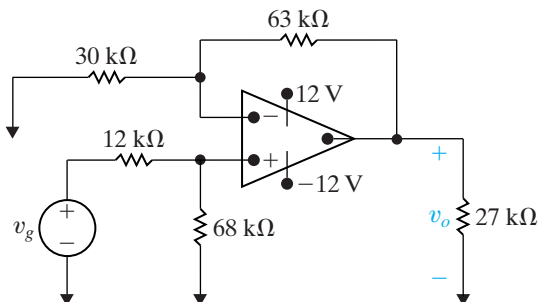
**5.20** The op amp in the circuit shown in Fig. P5.20 is ideal,

PSPICE  
MULTISIM

- Calculate  $v_o$  when  $v_g$  equals  $4 \text{ V}$ .
- Specify the range of values of  $v_g$  so that the op amp operates in a linear mode.

- c) Assume that  $v_g$  equals 2 V and that the 63 kΩ resistor is replaced with a variable resistor. What value of the variable resistor will cause the op amp to saturate?

Figure P5.20



- 5.21 a) Design a non-inverting amplifier (see Fig. 5.13) with a gain of 6, using a 75 kΩ resistor in the feedback path. Draw your final circuit diagram.  
 b) Suppose you wish to amplify input signals in the range  $-2.5 \text{ V} \leq v_g \leq 1.5 \text{ V}$ . What are the minimum values of the power supplies that will keep the op amp in its linear operating region?

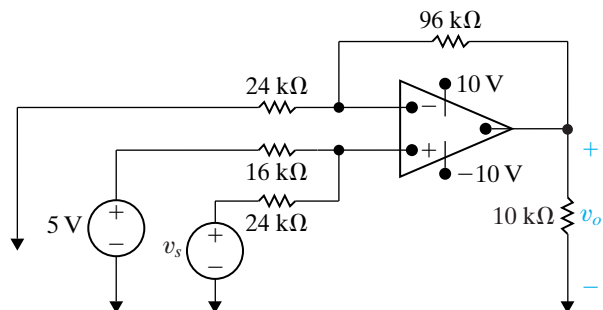
- 5.22 a) Design a non-inverting amplifier (see Fig. 5.13) with a gain of 2.5. Use resistors from Appendix H. You might need to combine resistors in series and in parallel to get the desired resistance. Draw your final circuit.  
 b) If you use  $\pm 16 \text{ V}$  power supplies for the op amp, what range of input values will allow the op amp to stay in its linear operating region?

5.23 The op amp in the circuit of Fig. P5.23 is ideal.

PSPICE  
MULTISIM

- a) What op amp circuit configuration is this?  
 b) Find  $v_o$  in terms of  $v_s$ .  
 c) Find the range of values for  $v_s$  such that  $v_o$  does not saturate and the op amp remains in its linear region of operation.

Figure P5.23



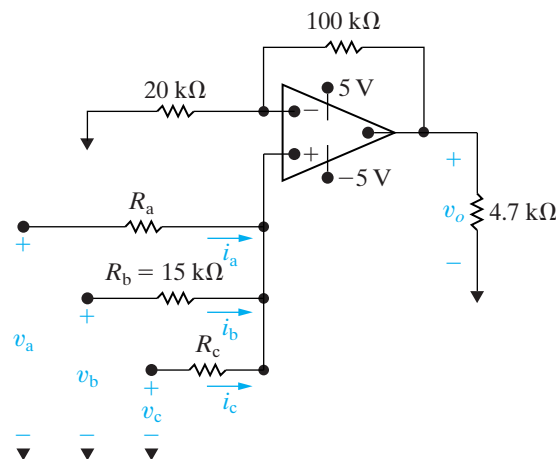
5.24 The circuit in Fig. P5.24 is a noninverting summing amplifier. Assume the op amp is ideal. Design the circuit so that

DESIGN  
PROBLEM  
PSPICE  
MULTISIM

$$v_o = v_a + 2v_b + 3v_c.$$

- a) Specify the numerical values of  $R_a$  and  $R_c$ .  
 b) Calculate  $i_a$ ,  $i_b$ , and  $i_c$  (in microamperes) when  $v_a = 0.7 \text{ V}$ ,  $v_b = 0.4 \text{ V}$ , and  $v_c = 1.1 \text{ V}$ .

Figure P5.24



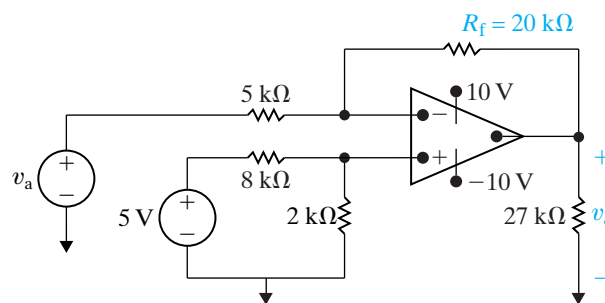
### Section 5.6

- 5.25 a) Use the principle of superposition to derive Eq. 5.22.  
 b) Derive Eqs. 5.23 and 5.24.

5.26 The op amp in the circuit of Fig. P5.26 is ideal.

- a) What op amp circuit configuration is this?  
 b) Find an expression for the output voltage  $v_o$  in terms of the input voltage  $v_a$ .  
 c) Suppose  $v_a = 2 \text{ V}$ . What value of  $R_f$  will cause the op amp to saturate?

Figure P5.26

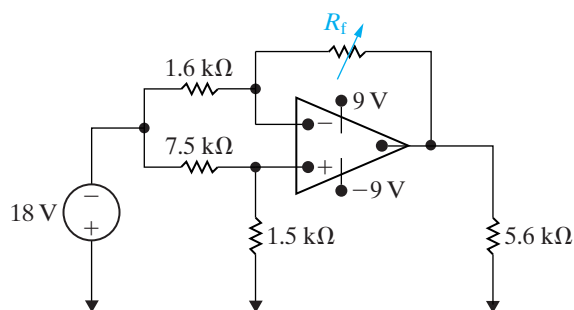


**5.27** The resistors in the difference amplifier shown in Fig. 5.15 are  $R_a = 24 \text{ k}\Omega$ ,  $R_b = 75 \text{ k}\Omega$ ,  $R_c = 130 \text{ k}\Omega$  and  $R_d = 120 \text{ k}\Omega$ . The signal voltages  $v_a$  and  $v_b$  are 8 and 5 V, respectively, and  $V_{CC} = \pm 20 \text{ V}$ .

- Find  $v_o$ .
- What is the resistance seen by the signal source  $v_a$ ?
- What is the resistance seen by the signal source  $v_b$ ?

**5.28** The resistor  $R_f$  in the circuit in Fig. P5.28 is adjusted until the ideal op amp saturates. Specify  $R_f$  in kilohms.

Figure P5.28

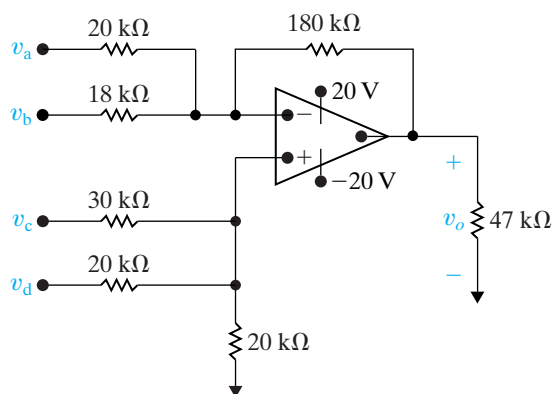


**5.29** Design a difference amplifier (Fig. 5.15) to meet the following criteria:  $v_o = 3v_b - 4v_a$ . The resistance seen by the signal source  $v_b$  is  $470 \text{ k}\Omega$ , and the resistance seen by the signal source  $v_a$  is  $22 \text{ k}\Omega$  when the output voltage  $v_o$  is zero. Specify the values of  $R_a$ ,  $R_b$ ,  $R_c$ , and  $R_d$  using single resistors or combinations of resistors from Appendix H.

**5.30** The op amp in the adder-subtractor circuit shown in Fig. P5.30 is ideal.

- Find  $v_o$  when  $v_a = 1 \text{ V}$ ,  $v_b = 2 \text{ V}$ ,  $v_c = 3 \text{ V}$ , and  $v_d = 4 \text{ V}$ .
- If  $v_a$ ,  $v_b$ , and  $v_d$  are held constant, what values of  $v_c$  will not saturate the op amp?

Figure P5.30

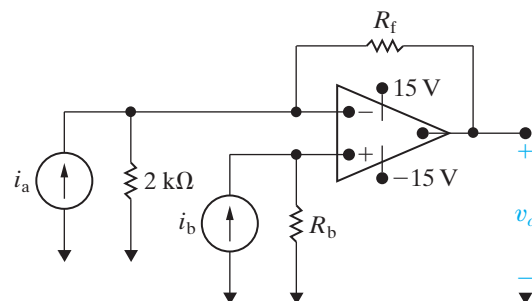


**5.31** Select the values of  $R_a$  and  $R_f$  in the circuit in Fig. P5.31 so that

$$v_o = 8000(i_b - i_a).$$

Use single resistors or combinations of resistors from Appendix H. The op amp is ideal.

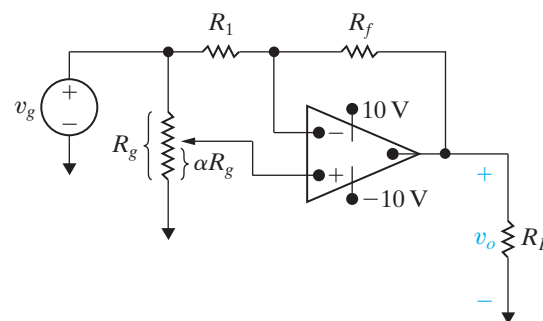
Figure P5.31



**5.32** The op amp in the circuit of Fig. P5.32 is ideal.

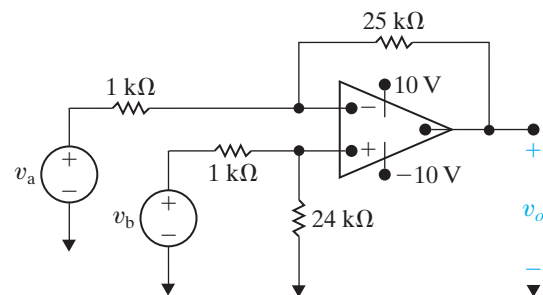
- Plot  $v_o$  versus  $\alpha$  when  $R_f = 4R_1$  and  $v_g = 2 \text{ V}$ . Use increments of 0.1 and note by hypothesis that  $0 \leq \alpha \leq 1.0$ .
- Write an equation for the straight line you plotted in (a). How are the slope and intercept of the line related to  $v_g$  and the ratio  $R_f/R_1$ ?
- Using the results from (b), choose values for  $v_g$  and the ratio  $R_f/R_1$  such that  $v_o = -6\alpha + 4$ .

Figure P5.32



**5.33** In the difference amplifier shown in Fig. P5.33, compute (a) the differential mode gain, (b) the common mode gain, and (c) the CMRR.

Figure P5.33





5.34 In the difference amplifier shown in Fig. P5.34, what range of values of  $R_x$  yields a CMRR  $\geq 1500$ ?

Figure P5.34

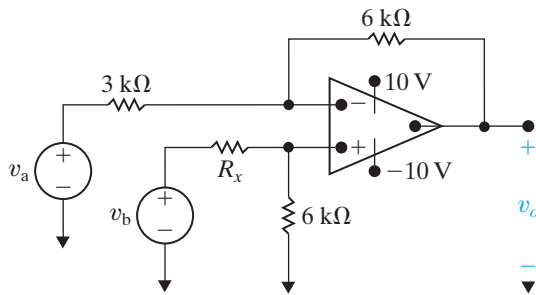
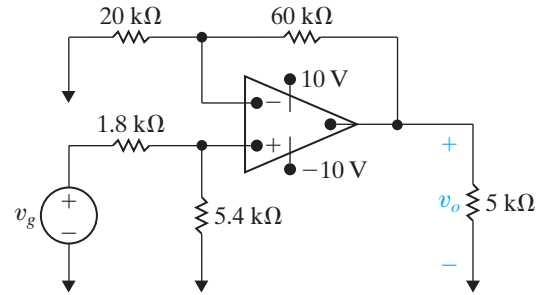


Figure P5.36



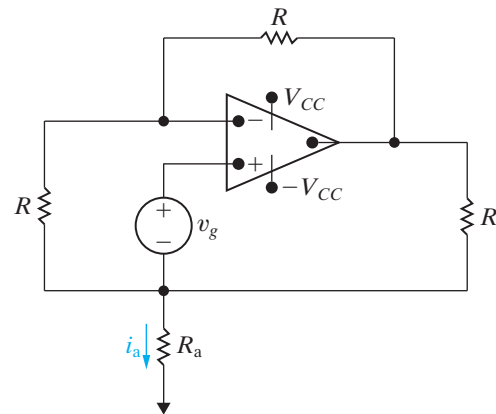
5.37 a) Show that when the ideal op amp in Fig. P5.37 is operating in its linear region,

$$i_a = \frac{3v_g}{R}.$$

b) Show that the ideal op amp will saturate when

$$R_a = \frac{R(\pm V_{CC} - 2v_g)}{3v_g}.$$

Figure P5.37



5.38 Assume that the ideal op amp in the circuit seen in Fig. P5.38 is operating in its linear region.

a) Show that  $v_o = [(R_1 + R_2)/R_1]v_s$ .

b) What happens if  $R_1 \rightarrow \infty$  and  $R_2 \rightarrow 0$ ?

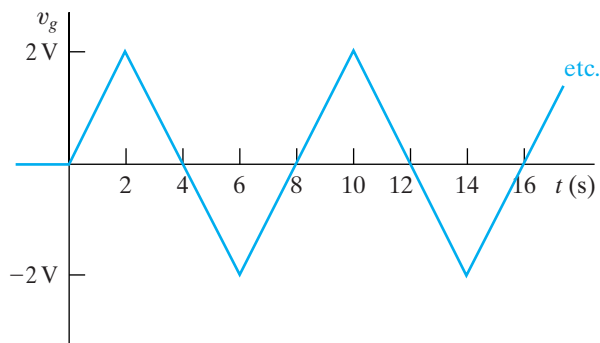
c) Explain why this circuit is referred to as a voltage follower when  $R_1 = \infty$  and  $R_2 = 0$ .

Sections 5.1–5.6

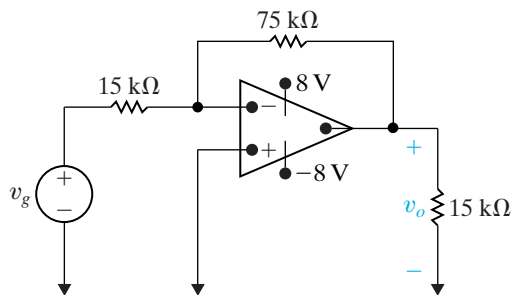
5.35 The voltage  $v_g$  shown in Fig. P5.35(a) is applied to the inverting amplifier shown in Fig. P5.35(b). Sketch  $v_o$  versus  $t$ , assuming the op amp is ideal.

PSPICE  
MULTISIM

Figure P5.35



(a)



(b)

5.36 The signal voltage  $v_g$  in the circuit shown in Fig. P5.36 is described by the following equations:

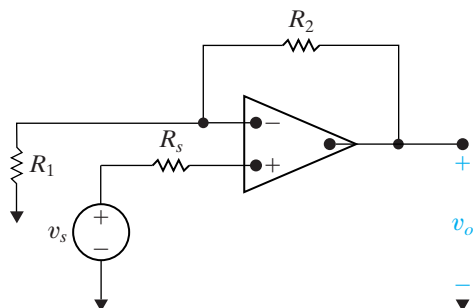
PSPICE  
MULTISIM

$$v_g = 0, \quad t \leq 0,$$

$$v_g = 4 \cos(\pi/4)t \text{ V}, \quad 0 \leq t \leq \infty.$$

Sketch  $v_o$  versus  $t$ , assuming the op amp is ideal.

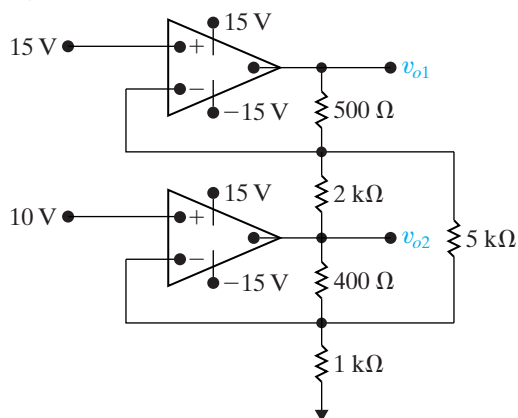
Figure P5.38



- 5.39** The two op amps in the circuit in Fig. P5.39 are ideal. Calculate  $v_{o1}$  and  $v_{o2}$ .

PSPICE  
MULTISIM

Figure P5.39

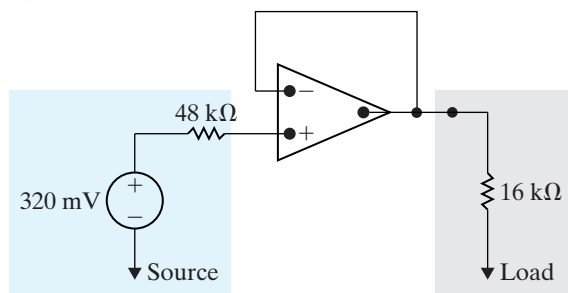


- 5.40** Assume that the ideal op amp in the circuit in Fig. P5.40 is operating in its linear region.

PSPICE  
MULTISIM

- Calculate the power delivered to the  $16\text{ k}\Omega$  resistor.
- Repeat (a) with the op amp removed from the circuit, that is, with the  $16\text{ k}\Omega$  resistor connected in the series with the voltage source and the  $48\text{ k}\Omega$  resistor.
- Find the ratio of the power found in (a) to that found in (b).
- Does the insertion of the op amp between the source and the load serve a useful purpose? Explain.

Figure P5.40

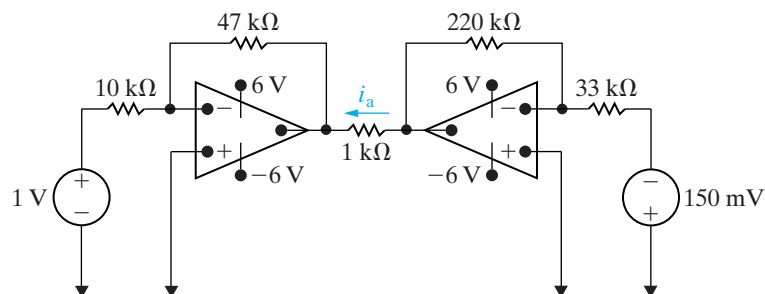


- 5.41** The op amps in the circuit in Fig. P5.41 are ideal.

PSPICE  
MULTISIM

- Find  $i_a$ .
- Find the value of the left source voltage for which  $i_a = 0$ .

Figure P5.41

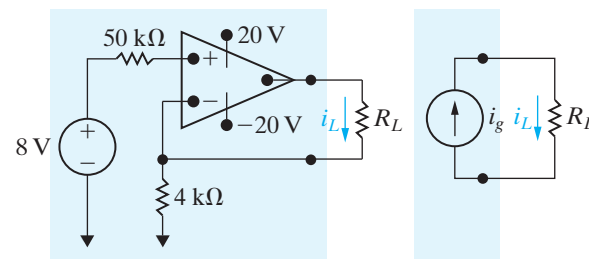


- 5.42** The circuit inside the shaded area in Fig. P5.42 is a constant current source for a limited range of values of  $R_L$ .

PSPICE  
MULTISIM

- Find the value of  $i_L$  for  $R_L = 4\text{ k}\Omega$ .
- Find the maximum value for  $R_L$  for which  $i_L$  will have the value in (a).
- Assume that  $R_L = 16\text{ k}\Omega$ . Explain the operation of the circuit. You can assume that  $i_n = i_p \approx 0$  under all operating conditions.
- Sketch  $i_L$  versus  $R_L$  for  $0 \leq R_L \leq 16\text{ k}\Omega$ .

Figure P5.42



### Section 5.7

- 5.43** Derive Eq. 5.60.

- 5.44** Repeat Assessment Problem 5.6, given that the inverting amplifier is loaded with a  $500\text{ }\Omega$  resistor.

PSPICE  
MULTISIM

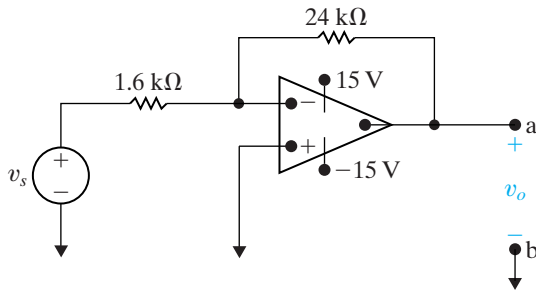
- 5.45** a) Find the Thévenin equivalent circuit with respect to the output terminals a, b for the inverting amplifier of Fig. P5.45. The dc signal source has a value of  $880\text{ mV}$ . The op amp has an input resistance of  $500\text{ k}\Omega$ , an output resistance of  $2\text{ k}\Omega$  and an open-loop gain of  $100,000$ .

PSPICE  
MULTISIM

- b) What is the output resistance of the inverting amplifier?

- c) What is the resistance (in ohms) seen by the signal source  $v_s$  when the load at the terminals a, b is  $330 \Omega$ ?

Figure P5.45



- 5.46 Repeat Problem 5.45 assuming an ideal op amp.

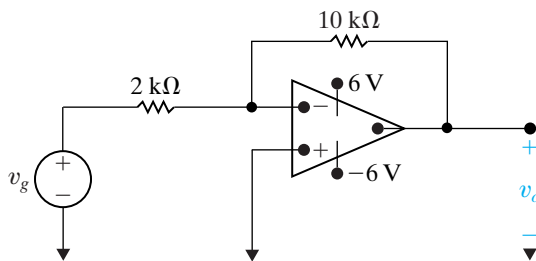
PSPICE  
MULTISIM

- 5.47 Assume the input resistance of the op amp in Fig. P5.47 is infinite and its output resistance is zero.

PSPICE  
MULTISIM

- Find  $v_o$  as a function of  $v_g$  and the open-loop gain  $A$ .
- What is the value of  $v_o$  if  $v_g = 1 \text{ V}$  and  $A = 150$ ?
- What is the value of  $v_o$  if  $v_g = 1 \text{ V}$  and  $A = \infty$ ?
- How large does  $A$  have to be so that  $v_o$  is 99% of its value in (c)?

Figure P5.47

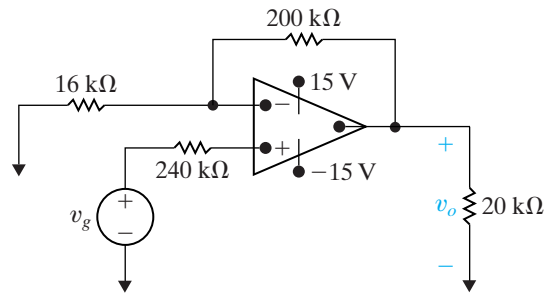


- 5.48 The op amp in the noninverting amplifier circuit of Fig. P5.48 has an input resistance of  $560 \text{ k}\Omega$ , an output resistance of  $8 \text{ k}\Omega$ , and an open-loop gain of 50,000. Assume that the op amp is operating in its linear region.

PSPICE  
MULTISIM

- Calculate the voltage gain ( $v_o/v_g$ ).
- Find the inverting and noninverting input voltages  $v_n$  and  $v_p$  (in millivolts) if  $v_g = 1 \text{ V}$ .
- Calculate the difference ( $v_p - v_n$ ) in microvolts when  $v_g = 1 \text{ V}$ .
- Find the current drain in picoamperes on the signal source  $v_g$  when  $v_g = 1 \text{ V}$ .
- Repeat (a)–(d) assuming an ideal op amp.

Figure P5.48



Sections 5.1–5.7

- 5.49 Suppose the strain gages in the bridge in Fig. 5.21 have the value  $120 \Omega \pm 1\%$ . The power supplies to the op amp are  $\pm 15 \text{ V}$ , and the reference voltage,  $v_{\text{ref}}$ , is taken from the positive power supply.

PRACTICAL  
PERSPECTIVE

- Calculate the value of  $R_f$  so that when the strain gage that is lengthening reaches its maximum length, the output voltage is 5 V.
- Suppose that we can accurately measure 50 mV changes in the output voltage. What change in strain gage resistance can be detected in milliohms?

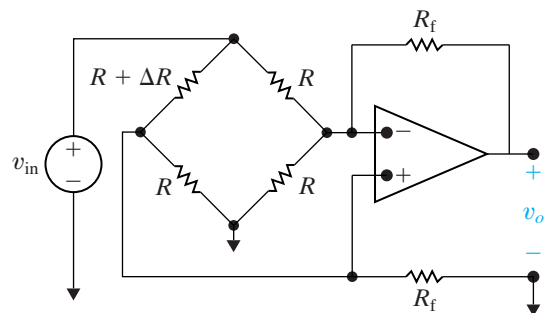
- 5.50 a) For the circuit shown in Fig. P5.50, show that if  $\Delta R \ll R$ , the output voltage of the op amp is approximately

PRACTICAL  
PERSPECTIVE  
PSPICE  
MULTISIM

$$v_o \approx \frac{R_f (R + R_f)}{R^2 (R + 2R_f)} (-\Delta R) v_{\text{in}}$$

- Find  $v_o$  if  $R_f = 470 \text{ k}\Omega$ ,  $R = 10 \text{ k}\Omega$ ,  $\Delta R = 95 \Omega$ , and  $v_{\text{in}} = 15 \text{ V}$ .
- Find the actual value of  $v_o$  in (b).

Figure P5.50



**5.51** a) If percent error is defined as

PRACTICAL  
PERSPECTIVE  
PSPICE  
MULTISIM

$$\% \text{ error} = \left[ \frac{\text{approximate value}}{\text{true value}} - 1 \right] \times 100,$$

show that the percent error in the approximation of  $v_o$  in Problem 5.50 is

$$\% \text{ error} = \frac{\Delta R}{R} \frac{(R + R_f)}{(R + 2R_f)} \times 100.$$

b) Calculate the percent error in  $v_o$  for Problem 5.50.

**5.52** Assume the percent error in the approximation of

PRACTICAL  
PERSPECTIVE  
PSPICE  
MULTISIM

$v_o$  in the circuit in Fig. P5.50 is not to exceed 1%. What is the largest percent change in  $R$  that can be tolerated?

**5.53** Assume the resistor in the variable branch of the bridge circuit in Fig. P5.50 is  $R - \Delta R$  instead of  $R + \Delta R$ .

PRACTICAL  
PERSPECTIVE  
PSPICE  
MULTISIM

- What is the expression for  $v_o$  if  $\Delta R \ll R$ ?
- What is the expression for the percent error in  $v_o$  as a function of  $R$ ,  $R_f$ , and  $\Delta R$ ?
- Assume the resistance in the variable arm of the bridge circuit in Fig. P5.50 is  $9810 \Omega$  and the values of  $R$ ,  $R_f$ , and  $v_{in}$  are the same as in Problem 5.50(b). What is the approximate value of  $v_o$ ?
- What is the percent error in the approximation of  $v_o$  when the variable arm resistance is  $9810 \Omega$ ?

# Inductance, Capacitance, and Mutual Inductance

## CHAPTER CONTENTS

- 6.1 The Inductor *p. 176*
- 6.2 The Capacitor *p. 182*
- 6.3 Series-Parallel Combinations of Inductance and Capacitance *p. 187*
- 6.4 Mutual Inductance *p. 189*
- 6.5 A Closer Look at Mutual Inductance *p. 193*

## ✓ CHAPTER OBJECTIVES

- 1 Know and be able to use the equations for voltage, current, power, and energy in an inductor; understand how an inductor behaves in the presence of constant current, and the requirement that the current be continuous in an inductor.
- 2 Know and be able to use the equations for voltage, current, power, and energy in a capacitor; understand how a capacitor behaves in the presence of constant voltage, and the requirement that the voltage be continuous in a capacitor.
- 3 Be able to combine inductors with initial conditions in series and in parallel to form a single equivalent inductor with an initial condition; be able to combine capacitors with initial conditions in series and in parallel to form a single equivalent capacitor with an initial condition.
- 4 Understand the basic concept of mutual inductance and be able to write mesh-current equations for a circuit containing magnetically coupled coils using the dot convention correctly.

We begin this chapter by introducing the last two ideal circuit elements mentioned in Chapter 2, namely, inductors and capacitors. Be assured that the circuit analysis techniques introduced in Chapters 3 and 4 apply to circuits containing inductors and capacitors. Therefore, once you understand the terminal behavior of these elements in terms of current and voltage, you can use Kirchhoff's laws to describe any interconnections with the other basic elements. Like other components, inductors and capacitors are easier to describe in terms of circuit variables rather than electromagnetic field variables. However, before we focus on the circuit descriptions, a brief review of the field concepts underlying these basic elements is in order.

An inductor is an electrical component that opposes any change in electrical current. It is composed of a coil of wire wound around a supporting core whose material may be magnetic or nonmagnetic. The behavior of inductors is based on phenomena associated with magnetic fields. The source of the magnetic field is charge in motion, or current. If the current is varying with time, the magnetic field is varying with time. A time-varying magnetic field induces a voltage in any conductor linked by the field. The circuit parameter of **inductance** relates the induced voltage to the current. We discuss this quantitative relationship in Section 6.1.

A capacitor is an electrical component that consists of two conductors separated by an insulator or dielectric material. The capacitor is the only device other than a battery that can store electrical charge. The behavior of capacitors is based on phenomena associated with electric fields. The source of the electric field is separation of charge, or voltage. If the voltage is varying with time, the electric field is varying with time. A time-varying electric field produces a displacement current in the space occupied by the field. The circuit parameter of **capacitance** relates the displacement current to the voltage, where the displacement current is equal to the conduction current at the terminals of the capacitor. We discuss this quantitative relationship in Section 6.2.

## Practical Perspective

### Capacitive Touch Screens

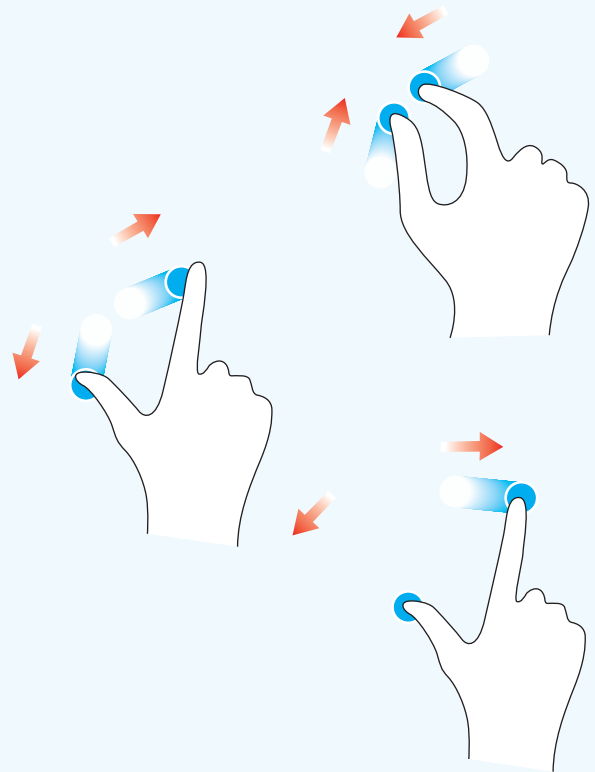
The Practical Perspective in Chapter 3 showed how a grid of resistors is used to create a touch screen for a phone or computer monitor. But resistive touch screens have some limitations, the most important of which is that the screen can only process a single touch at any instant in time (see Problem 3.75). For example, a resistive touch screen cannot process the “pinch” gesture used by many devices to enlarge or shrink the image on the screen.

Multi-touch screens use a different component within a grid below the screen – capacitors. As you are about to

discover in this chapter, a capacitor is a circuit element whose terminal characteristics are determined by electric fields. When you touch a capacitive touch screen, you produce a change in the value of a capacitor, causing a voltage change. Once you have learned the basic behavior of capacitors and have learned how they combine in series and in parallel, we will present two possible designs for a multi-touch screen using a grid of capacitors. These designs are presented in the Practical Perspective example at the end of this chapter.



cobalt88/Shutterstock



Section 6.3 describes techniques used to simplify circuits with series or parallel combinations of capacitors or inductors.

Energy can be stored in both magnetic and electric fields. Hence you should not be too surprised to learn that inductors and capacitors are capable of storing energy. For example, energy can be stored in an inductor and then released to fire a spark plug. Energy can be stored in a capacitor and then released to fire a flashbulb. In ideal inductors and capacitors, only as much energy can be extracted as has been stored. Because inductors and capacitors cannot generate energy, they are classified as **passive elements**.

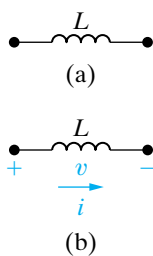
In Sections 6.4 and 6.5 we consider the situation in which two circuits are linked by a magnetic field and thus are said to be magnetically coupled. In this case, the voltage induced in the second circuit can be related to the time-varying current in the first circuit by a parameter known as **mutual inductance**. The practical significance of magnetic coupling unfolds as we study the relationships between current, voltage, power, and several new parameters specific to mutual inductance. We introduce these relationships here and then describe their utility in a device called a transformer in Chapters 9 and 10.

## 6.1 The Inductor

Inductance is the circuit parameter used to describe an inductor. Inductance is symbolized by the letter  $L$ , is measured in henrys (H), and is represented graphically as a coiled wire—a reminder that inductance is a consequence of a conductor linking a magnetic field. Figure 6.1(a) shows an inductor. Assigning the reference direction of the current in the direction of the voltage drop across the terminals of the inductor, as shown in Fig. 6.1(b), yields

The inductor  $v - i$  equation ►

$$v = L \frac{di}{dt}, \quad (6.1)$$



**Figure 6.1** ▲ (a) The graphic symbol for an inductor with an inductance of  $L$  henrys. (b) Assigning reference voltage and current to the inductor, following the passive sign convention.

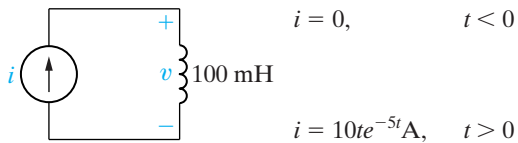
where  $v$  is measured in volts,  $L$  in henrys,  $i$  in amperes, and  $t$  in seconds. Equation 6.1 reflects the passive sign convention shown in Fig. 6.1(b); that is, the current reference is in the direction of the voltage drop across the inductor. If the current reference is in the direction of the voltage rise, Eq. 6.1 is written with a minus sign.

Note from Eq. 6.1 that the voltage across the terminals of an inductor is proportional to the time rate of change of the current in the inductor. We can make two important observations here. First, if the current is constant, the voltage across the ideal inductor is zero. Thus the inductor behaves as a short circuit in the presence of a constant, or dc, current. Second, current cannot change instantaneously in an inductor; that is, the current cannot change by a finite amount in zero time. Equation 6.1 tells us that this change would require an infinite voltage, and infinite voltages are not possible. For example, when someone opens the switch on an inductive circuit in an actual system, the current initially continues to flow in the air across the switch, a phenomenon called *arcing*. The arc across the switch prevents the current from dropping to zero instantaneously. Switching inductive circuits is an important engineering problem, because arcing and voltage surges must be controlled to prevent equipment damage. The first step to understanding the nature of this problem is to master the introductory material presented in this and the following two chapters. Example 6.1 illustrates the application of Eq. 6.1 to a simple circuit.



**Example 6.1** Determining the Voltage, Given the Current, at the Terminals of an Inductor

The independent current source in the circuit shown in Fig. 6.2 generates zero current for  $t < 0$  and a pulse  $10te^{-5t}$  A, for  $t > 0$ .



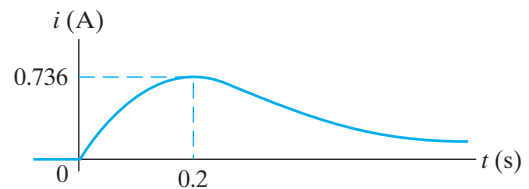
**Figure 6.2** ▲ The circuit for Example 6.1.

- Sketch the current waveform.
- At what instant of time is the current maximum?
- Express the voltage across the terminals of the 100 mH inductor as a function of time.
- Sketch the voltage waveform.
- Are the voltage and the current at a maximum at the same time?
- At what instant of time does the voltage change polarity?
- Is there ever an instantaneous change in voltage across the inductor? If so, at what time?

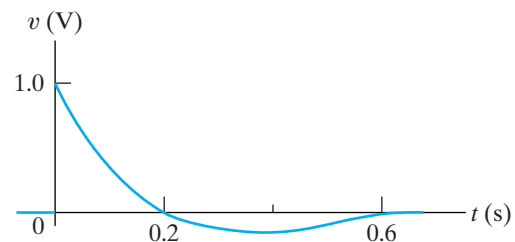
**Solution**

- Figure 6.3 shows the current waveform.
- $di/dt = 10(-5te^{-5t} + e^{-5t}) = 10e^{-5t}(1 - 5t)$  A/s;  $di/dt = 0$  when  $t = \frac{1}{5}$  s. (See Fig. 6.3.)

- $v = Ldi/dt = (0.1)10e^{-5t}(1 - 5t) = e^{-5t}(1 - 5t)$  V,  $t > 0$ ;  $v = 0$ ,  $t < 0$ .
- Figure 6.4 shows the voltage waveform.
- No; the voltage is proportional to  $di/dt$ , not  $i$ .
- At 0.2 s, which corresponds to the moment when  $di/dt$  is passing through zero and changing sign.
- Yes, at  $t = 0$ . Note that the voltage can change instantaneously across the terminals of an inductor.



**Figure 6.3** ▲ The current waveform for Example 6.1.



**Figure 6.4** ▲ The voltage waveform for Example 6.1.

**Current in an Inductor in Terms of the Voltage Across the Inductor**

Equation 6.1 expresses the voltage across the terminals of an inductor as a function of the current in the inductor. Also desirable is the ability to express the current as a function of the voltage. To find  $i$  as a function of  $v$ , we start by multiplying both sides of Eq. 6.1 by a differential time  $dt$ :

$$v dt = L \left( \frac{di}{dt} \right) dt. \quad (6.2)$$

Multiplying the rate at which  $i$  varies with  $t$  by a differential change in time generates a differential change in  $i$ , so we write Eq. 6.2 as

$$v dt = L di. \quad (6.3)$$

We next integrate both sides of Eq. 6.3. For convenience, we interchange the two sides of the equation and write

$$L \int_{i(t_0)}^{i(t)} dx = \int_{t_0}^t v d\tau. \quad (6.4)$$

Note that we use  $x$  and  $\tau$  as the variables of integration, whereas  $i$  and  $t$  become limits on the integrals. Then, from Eq. 6.4,

**The inductor  $i - v$  equation** ▶

$$i(t) = \frac{1}{L} \int_{t_0}^t v d\tau + i(t_0), \quad (6.5)$$

where  $i(t)$  is the current corresponding to  $t$ , and  $i(t_0)$  is the value of the inductor current when we initiate the integration, namely,  $t_0$ . In many practical applications,  $t_0$  is zero and Eq. 6.5 becomes

$$i(t) = \frac{1}{L} \int_0^t v d\tau + i(0). \quad (6.6)$$

Equations 6.1 and 6.5 both give the relationship between the voltage and current at the terminals of an inductor. Equation 6.1 expresses the voltage as a function of current, whereas Eq. 6.5 expresses the current as a function of voltage. In both equations the reference direction for the current is in the direction of the voltage drop across the terminals. Note that  $i(t_0)$  carries its own algebraic sign. If the initial current is in the same direction as the reference direction for  $i$ , it is a positive quantity. If the initial current is in the opposite direction, it is a negative quantity. Example 6.2 illustrates the application of Eq. 6.5.

### Example 6.2 Determining the Current, Given the Voltage, at the Terminals of an Inductor

The voltage pulse applied to the 100 mH inductor shown in Fig. 6.5 is 0 for  $t < 0$  and is given by the expression

$$v(t) = 20te^{-10t} \text{ V}$$

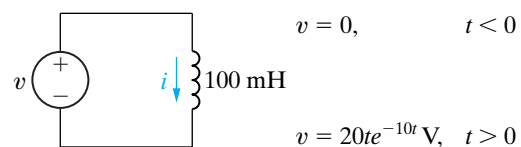
for  $t > 0$ . Also assume  $i = 0$  for  $t \leq 0$ .

- Sketch the voltage as a function of time.
- Find the inductor current as a function of time.
- Sketch the current as a function of time.

- The current in the inductor is 0 at  $t = 0$ . Therefore, the current for  $t > 0$  is

$$\begin{aligned} i &= \frac{1}{0.1} \int_0^t 20\tau e^{-10\tau} d\tau + 0 \\ &= 200 \left[ \frac{-e^{-10\tau}}{100} (10\tau + 1) \right]_0^t, \\ &= 2(1 - 10te^{-10t} - e^{-10t}) \text{ A}, \quad t > 0. \end{aligned}$$

- Figure 6.7 shows the current as a function of time.



**Figure 6.5** ▲ The circuit for Example 6.2.

### Solution

- The voltage as a function of time is shown in Fig. 6.6.

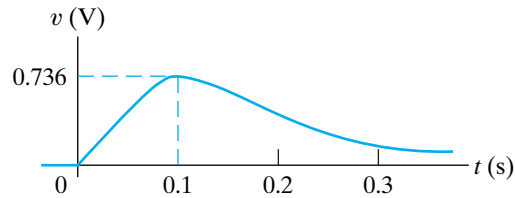


Figure 6.6 ▲ The voltage waveform for Example 6.2.

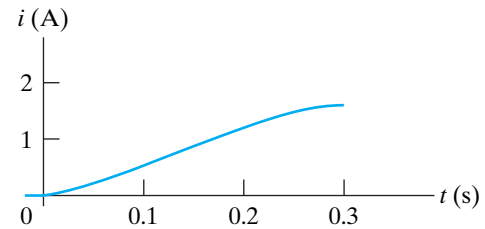


Figure 6.7 ▲ The current waveform for Example 6.2.

Note in Example 6.2 that  $i$  approaches a constant value of 2 A as  $t$  increases. We say more about this result after discussing the energy stored in an inductor.

### Power and Energy in the Inductor

The power and energy relationships for an inductor can be derived directly from the current and voltage relationships. If the current reference is in the direction of the voltage drop across the terminals of the inductor, the power is

$$p = vi. \quad (6.7)$$

Remember that power is in watts, voltage is in volts, and current is in amperes. If we express the inductor voltage as a function of the inductor current, Eq. 6.7 becomes

$$p = Li \frac{di}{dt}. \quad (6.8) \quad \blacktriangleleft \text{Power in an inductor}$$

We can also express the current in terms of the voltage:

$$p = v \left[ \frac{1}{L} \int_{t_0}^t v \, d\tau + i(t_0) \right]. \quad (6.9)$$

Equation 6.8 is useful in expressing the energy stored in the inductor. Power is the time rate of expending energy, so

$$p = \frac{dw}{dt} = Li \frac{di}{dt}. \quad (6.10)$$

Multiplying both sides of Eq. 6.10 by a differential time gives the differential relationship

$$dw = Li \, di. \quad (6.11)$$

Both sides of Eq. 6.11 are integrated with the understanding that the reference for zero energy corresponds to zero current in the inductor. Thus

$$\int_0^w dx = L \int_0^i y \, dy,$$

$$w = \frac{1}{2} Li^2. \quad (6.12) \quad \blacktriangleleft \text{Energy in an inductor}$$

As before, we use different symbols of integration to avoid confusion with the limits placed on the integrals. In Eq. 6.12, the energy is in joules, inductance is in henrys, and current is in amperes. To illustrate the application of Eqs. 6.7 and 6.12, we return to Examples 6.1 and 6.2 by means of Example 6.3.

### Example 6.3 Determining the Current, Voltage, Power, and Energy for an Inductor

- For Example 6.1, plot  $i$ ,  $v$ ,  $p$ , and  $w$  versus time. Line up the plots vertically to allow easy assessment of each variable's behavior.
- In what time interval is energy being stored in the inductor?
- In what time interval is energy being extracted from the inductor?
- What is the maximum energy stored in the inductor?
- Evaluate the integrals

$$\int_0^{0.2} p \, dt \quad \text{and} \quad \int_{0.2}^{\infty} p \, dt,$$

and comment on their significance.

- Repeat (a)–(c) for Example 6.2.
- In Example 6.2, why is there a sustained current in the inductor as the voltage approaches zero?

### Solution

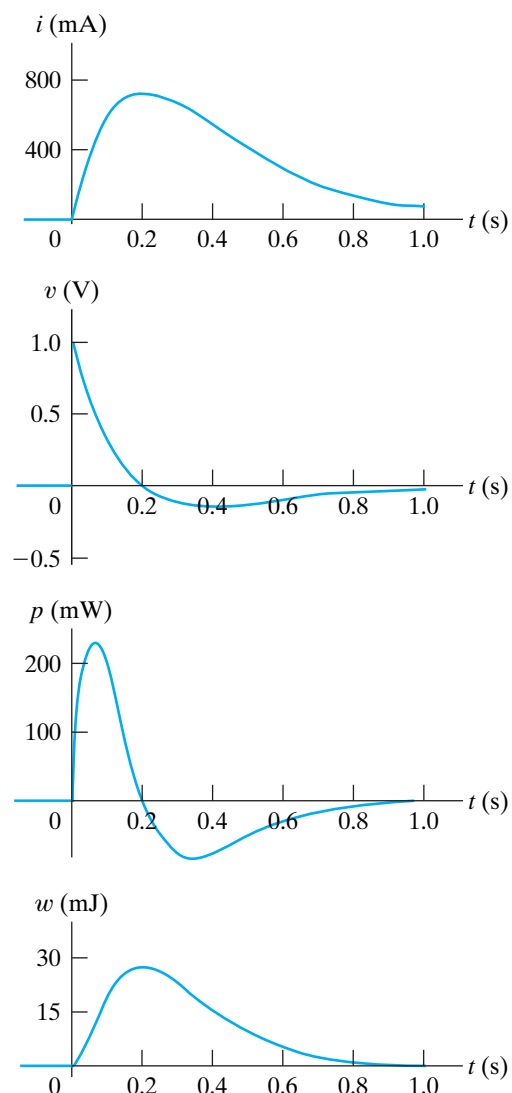
- The plots of  $i$ ,  $v$ ,  $p$ , and  $w$  follow directly from the expressions for  $i$  and  $v$  obtained in Example 6.1 and are shown in Fig. 6.8. In particular,  $p = vi$ , and  $w = (\frac{1}{2})Li^2$ .
- An increasing energy curve indicates that energy is being stored. Thus energy is being stored in the time interval 0 to 0.2 s. Note that this corresponds to the interval when  $p > 0$ .
- A decreasing energy curve indicates that energy is being extracted. Thus energy is being extracted in the time interval 0.2 s to  $\infty$ . Note that this corresponds to the interval when  $p < 0$ .
- From Eq. 6.12 we see that energy is at a maximum when current is at a maximum; glancing at the graphs confirms this. From Example 6.1, maximum current = 0.736 A. Therefore,  $w_{\max} = 27.07$  mJ.

- From Example 6.1,

$$i = 10te^{-5t} \text{ A} \quad \text{and} \quad v = e^{-5t}(1 - 5t) \text{ V}.$$

Therefore,

$$p = vi = 10te^{-10t} - 50t^2e^{-10t} \text{ W}.$$



**Figure 6.8** ▲ The variables  $i$ ,  $v$ ,  $p$ , and  $w$  versus  $t$  for Example 6.1.

Thus

$$\int_0^{0.2} p \, dt = 10 \left[ \frac{e^{-10t}}{100} (-10t - 1) \right]_0^{0.2}$$

$$- 50 \left\{ \frac{t^2 e^{-10t}}{-10} + \frac{2}{10} \left[ \frac{e^{-10t}}{100} (-10t - 1) \right] \right\}_0^{0.2}$$

$$= 0.2e^{-2} = 27.07 \text{ mJ},$$

$$\int_{0.2}^{\infty} p \, dt = 10 \left[ \frac{e^{-10t}}{100} (-10t - 1) \right]_{0.2}^{\infty}$$

$$- 50 \left\{ \frac{t^2 e^{-10t}}{-10} + \frac{2}{10} \left[ \frac{e^{-10t}}{100} (-10t - 1) \right] \right\}_{0.2}^{\infty}$$

$$= -0.2e^{-2} = -27.07 \text{ mJ}.$$

Based on the definition of  $p$ , the area under the plot of  $p$  versus  $t$  represents the energy expended over the interval of integration. Hence the integration of the power between 0 and 0.2 s represents the energy stored in the inductor during this time interval. The integral of  $p$  over the interval 0.2 s –  $\infty$  is the energy extracted. Note that in this time interval, all the energy originally stored is removed; that is, after the current peak has passed, no energy is stored in the inductor.

f) The plots of  $v$ ,  $i$ ,  $p$ , and  $w$  follow directly from the expressions for  $v$  and  $i$  given in Example 6.2 and are shown in Fig. 6.9. Note that in this case the power is always positive, and hence energy is always being stored during the voltage pulse.

g) The application of the voltage pulse stores energy in the inductor. Because the inductor is ideal, this energy cannot dissipate after the voltage subsides to zero. Therefore, a sustained current circulates in the circuit. A lossless inductor obviously is an ideal circuit element. Practical inductors require a resistor in the circuit model. (More about this later.)

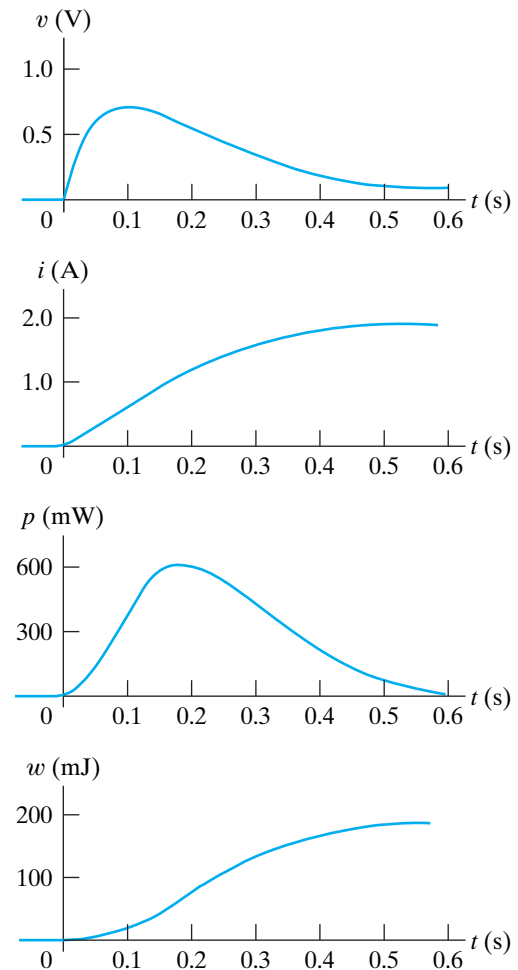


Figure 6.9 ▲ The variables  $v$ ,  $i$ ,  $p$ , and  $w$  versus  $t$  for Example 6.2.

## ASSESSMENT PROBLEM

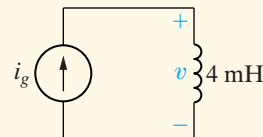
**Objective 1—Know and be able to use the equations for voltage, current, power, and energy in an inductor**

6.1 The current source in the circuit shown generates the current pulse

$$i_g(t) = 0, \quad t < 0,$$

$$i_g(t) = 8e^{-300t} - 8e^{-1200t} \text{ A}, \quad t \geq 0.$$

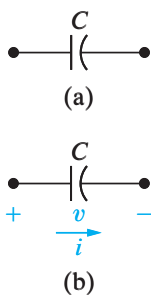
Find (a)  $v(0)$ ; (b) the instant of time, greater than zero, when the voltage  $v$  passes through zero; (c) the expression for the power delivered to the inductor; (d) the instant when the power delivered to the inductor is maximum; (e) the maximum power; (f) the instant of time when the stored energy is maximum; and (g) the maximum energy stored in the inductor.



- Answer:** (a) 28.8 V;  
 (b) 1.54 ms;  
 (c)  $-76.8e^{-600t} + 384e^{-1500t} - 307.2e^{-2400t}$  W,  $t \geq 0$ ;  
 (d) 411.05  $\mu$ s;  
 (e) 32.72 W;  
 (f) 1.54 ms;  
 (g) 28.57 mJ.

*NOTE: Also try Chapter Problems 6.2 and 6.8.*

## 6.2 The Capacitor



**Figure 6.10** (a) The circuit symbol for a capacitor. (b) Assigning reference voltage and current to the capacitor, following the passive sign convention.

The circuit parameter of capacitance is represented by the letter  $C$ , is measured in farads (F), and is symbolized graphically by two short parallel conductive plates, as shown in Fig. 6.10(a). Because the farad is an extremely large quantity of capacitance, practical capacitor values usually lie in the picofarad (pF) to microfarad ( $\mu$ F) range.

The graphic symbol for a capacitor is a reminder that capacitance occurs whenever electrical conductors are separated by a dielectric, or insulating, material. This condition implies that electric charge is not transported through the capacitor. Although applying a voltage to the terminals of the capacitor cannot move a charge through the dielectric, it can displace a charge within the dielectric. As the voltage varies with time, the displacement of charge also varies with time, causing what is known as the **displacement current**.

At the terminals, the displacement current is indistinguishable from a conduction current. The current is proportional to the rate at which the voltage across the capacitor varies with time, or, mathematically,

**Capacitor  $i - v$  equation** ►

$$i = C \frac{dv}{dt}, \quad (6.13)$$

where  $i$  is measured in amperes,  $C$  in farads,  $v$  in volts, and  $t$  in seconds.

Equation 6.13 reflects the passive sign convention shown in Fig. 6.10(b); that is, the current reference is in the direction of the voltage drop across the capacitor. If the current reference is in the direction of the voltage rise, Eq. 6.13 is written with a minus sign.

Two important observations follow from Eq. 6.13. First, voltage cannot change instantaneously across the terminals of a capacitor. Equation 6.13 indicates that such a change would produce infinite current, a physical impossibility. Second, if the voltage across the terminals is constant, the capacitor current is zero. The reason is that a conduction current cannot be established in the dielectric material of the capacitor. Only a time-varying voltage can produce a displacement current. Thus a capacitor behaves as an open circuit in the presence of a constant voltage.

Equation 6.13 gives the capacitor current as a function of the capacitor voltage. Expressing the voltage as a function of the current is also useful. To do so, we multiply both sides of Eq. 6.13 by a differential time  $dt$  and then integrate the resulting differentials:

$$i dt = C dv \quad \text{or} \quad \int_{v(t_0)}^{v(t)} dx = \frac{1}{C} \int_{t_0}^t i d\tau.$$

Carrying out the integration of the left-hand side of the second equation gives

$$v(t) = \frac{1}{C} \int_{t_0}^t i d\tau + v(t_0). \quad (6.14) \quad \blacktriangleleft \text{Capacitor } v - i \text{ equation}$$

In many practical applications of Eq. 6.14, the initial time is zero; that is,  $t_0 = 0$ . Thus Eq. 6.14 becomes

$$v(t) = \frac{1}{C} \int_0^t i d\tau + v(0). \quad (6.15)$$

We can easily derive the power and energy relationships for the capacitor. From the definition of power,

$$p = vi = Cv \frac{dv}{dt}, \quad (6.16) \quad \blacktriangleleft \text{Capacitor power equation}$$

or

$$p = i \left[ \frac{1}{C} \int_{t_0}^t i d\tau + v(t_0) \right]. \quad (6.17)$$



Combining the definition of energy with Eq. 6.16 yields

$$dw = Cv dv,$$

from which

$$\int_0^w dx = C \int_0^v y dy,$$

or

**Capacitor energy equation** ▶

$$w = \frac{1}{2}Cv^2. \quad (6.18)$$

In the derivation of Eq. 6.18, the reference for zero energy corresponds to zero voltage.

Examples 6.4 and 6.5 illustrate the application of the current, voltage, power, and energy relationships for a capacitor.

#### Example 6.4 Determining Current, Voltage, Power, and Energy for a Capacitor

The voltage pulse described by the following equations is impressed across the terminals of a  $0.5 \mu\text{F}$  capacitor:

$$v(t) = \begin{cases} 0, & t \leq 0 \text{ s}; \\ 4t \text{ V}, & 0 \text{ s} \leq t \leq 1 \text{ s}; \\ 4e^{-(t-1)} \text{ V}, & t \geq 1 \text{ s}. \end{cases}$$

- Derive the expressions for the capacitor current, power, and energy.
- Sketch the voltage, current, power, and energy as functions of time. Line up the plots vertically.
- Specify the interval of time when energy is being stored in the capacitor.
- Specify the interval of time when energy is being delivered by the capacitor.
- Evaluate the integrals

$$\int_0^1 p dt \quad \text{and} \quad \int_1^\infty p dt$$

and comment on their significance.

#### Solution

a) From Eq. 6.13,

$$i = \begin{cases} (0.5 \times 10^{-6})(0) = 0, & t < 0 \text{ s}; \\ (0.5 \times 10^{-6})(4) = 2 \mu\text{A}, & 0 \text{ s} < t < 1 \text{ s}; \\ (0.5 \times 10^{-6})(-4e^{-(t-1)}) = -2e^{-(t-1)} \mu\text{A}, & t > 1 \text{ s}. \end{cases}$$

The expression for the power is derived from Eq. 6.16:

$$p = \begin{cases} 0, & t \leq 0 \text{ s}; \\ (4t)(2) = 8t \mu\text{W}, & 0 \text{ s} \leq t < 1 \text{ s}; \\ (4e^{-(t-1)})(-2e^{-(t-1)}) = -8e^{-2(t-1)} \mu\text{W}, & t > 1 \text{ s}. \end{cases}$$

The energy expression follows directly from Eq. 6.18:

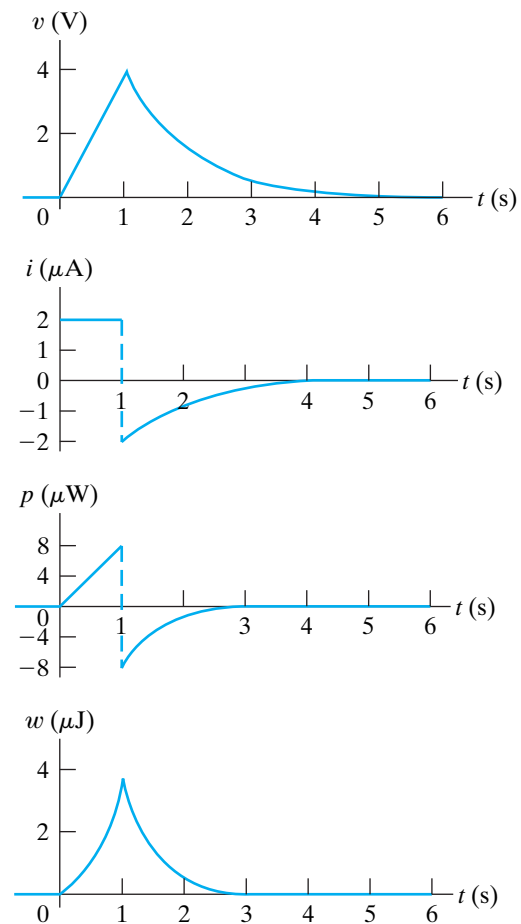
$$w = \begin{cases} 0, & t \leq 0 \text{ s}; \\ \frac{1}{2}(0.5)16t^2 = 4t^2 \mu\text{J}, & 0 \text{ s} \leq t \leq 1 \text{ s}; \\ \frac{1}{2}(0.5)16e^{-2(t-1)} = 4e^{-2(t-1)} \mu\text{J}, & t \geq 1 \text{ s}. \end{cases}$$

- b) Figure 6.11 shows the voltage, current, power, and energy as functions of time.
- c) Energy is being stored in the capacitor whenever the power is positive. Hence energy is being stored in the interval 0–1 s.
- d) Energy is being delivered by the capacitor whenever the power is negative. Thus energy is being delivered for all  $t$  greater than 1 s.
- e) The integral of  $p dt$  is the energy associated with the time interval corresponding to the limits on the integral. Thus the first integral represents the energy stored in the capacitor between 0 and 1 s, whereas the second integral represents the energy returned, or delivered, by the capacitor in the interval 1 s to  $\infty$ :

$$\int_0^1 p dt = \int_0^1 8t dt = 4t^2 \Big|_0^1 = 4 \mu\text{J},$$

$$\int_1^{\infty} p dt = \int_1^{\infty} (-8e^{-2(t-1)}) dt = (-8) \frac{e^{-2(t-1)}}{-2} \Big|_1^{\infty} = -4 \mu\text{J}.$$

The voltage applied to the capacitor returns to zero as time increases without limit, so the energy returned by this ideal capacitor must equal the energy stored.



**Figure 6.11** ▲ The variables  $v$ ,  $i$ ,  $p$ , and  $w$  versus  $t$  for Example 6.4.

### Example 6.5 Finding $v$ , $p$ , and $w$ Induced by a Triangular Current Pulse for a Capacitor

An uncharged  $0.2 \mu\text{F}$  capacitor is driven by a triangular current pulse. The current pulse is described by

$$i(t) = \begin{cases} 0, & t \leq 0; \\ 5000t \text{ A}, & 0 \leq t \leq 20 \mu\text{s}; \\ 0.2 - 5000t \text{ A}, & 20 \leq t \leq 40 \mu\text{s}; \\ 0, & t \geq 40 \mu\text{s}. \end{cases}$$

- a) Derive the expressions for the capacitor voltage, power, and energy for each of the four time intervals needed to describe the current.
- b) Plot  $i$ ,  $v$ ,  $p$ , and  $w$  versus  $t$ . Align the plots as specified in the previous examples.
- c) Why does a voltage remain on the capacitor after the current returns to zero?

### Solution

- a) For  $t \leq 0$ ,  $v$ ,  $p$ , and  $w$  all are zero.

For  $0 \leq t \leq 20 \mu\text{s}$ ,

$$v = 5 \times 10^6 \int_0^t (5000\tau) d\tau + 0 = 12.5 \times 10^9 t^2 \text{ V},$$

$$p = vi = 62.5 \times 10^{12} t^3 \text{ W},$$

$$w = \frac{1}{2} C v^2 = 15.625 \times 10^{12} t^4 \text{ J}.$$

For  $20 \mu\text{s} \leq t \leq 40 \mu\text{s}$ ,

$$v = 5 \times 10^6 \int_{20\mu\text{s}}^t (0.2 - 5000\tau) d\tau + 5.$$

(Note that 5 V is the voltage on the capacitor at the end of the preceding interval.) Then,

$$v = (10^6 t - 12.5 \times 10^9 t^2 - 10) \text{ V},$$

$$p = vi,$$

$$= (62.5 \times 10^{12} t^3 - 7.5 \times 10^9 t^2 + 2.5 \times 10^5 t - 2) \text{ W},$$

$$w = \frac{1}{2} C v^2,$$

$$= (15.625 \times 10^{12} t^4 - 2.5 \times 10^9 t^3 + 0.125 \times 10^6 t^2 - 2t + 10^{-5}) \text{ J}.$$

For  $t \geq 40 \mu\text{s}$ ,

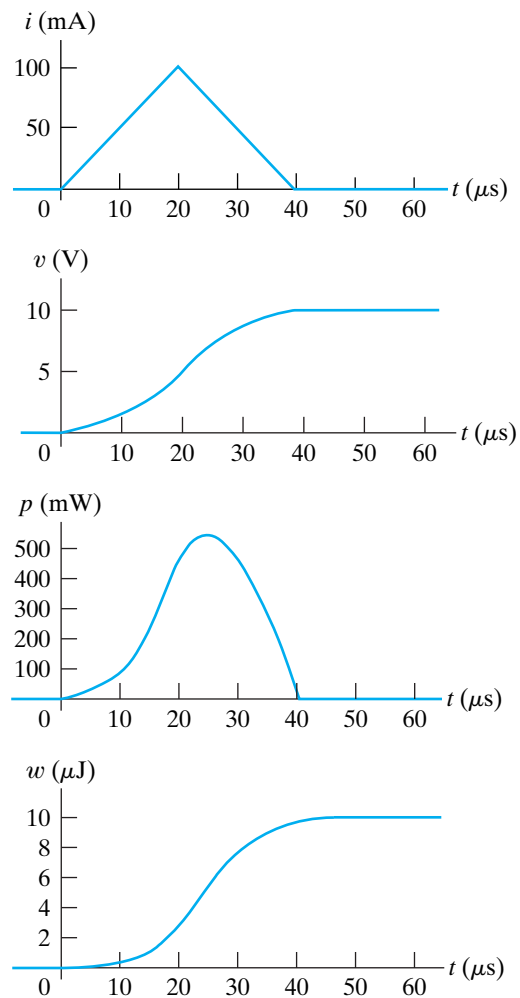
$$v = 10 \text{ V},$$

$$p = vi = 0,$$

$$w = \frac{1}{2} C v^2 = 10 \mu\text{J}.$$

b) The excitation current and the resulting voltage, power, and energy are plotted in Fig. 6.12.

c) Note that the power is always positive for the duration of the current pulse, which means that energy is continuously being stored in the capacitor. When the current returns to zero, the stored energy is trapped because the ideal capacitor offers no means for dissipating energy. Thus a voltage remains on the capacitor after  $i$  returns to zero.

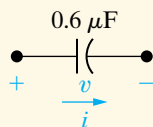


**Figure 6.12** ▲ The variables  $i$ ,  $v$ ,  $p$ , and  $w$  versus  $t$  for Example 6.5.

## ASSESSMENT PROBLEMS

**Objective 2—Know and be able to use the equations for voltage, current, power, and energy in a capacitor**

**6.2** The voltage at the terminals of the  $0.6 \mu\text{F}$  capacitor shown in the figure is 0 for  $t < 0$  and  $40e^{-15,000t} \sin 30,000t \text{ V}$  for  $t \geq 0$ . Find (a)  $i(0)$ ; (b) the power delivered to the capacitor at  $t = \pi/80 \text{ ms}$ ; and (c) the energy stored in the capacitor at  $t = \pi/80 \text{ ms}$ .



*NOTE: Also try Chapter Problems 6.16 and 6.21.*

**Answer:** (a) 0.72 A;  
(b)  $-649.2 \text{ mW}$ ;  
(c)  $126.13 \mu\text{J}$ .

**6.3** The current in the capacitor of Assessment Problem 6.2 is 0 for  $t < 0$  and  $3 \cos 50,000t \text{ A}$  for  $t \geq 0$ . Find (a)  $v(t)$ ; (b) the maximum power delivered to the capacitor at any one instant of time; and (c) the maximum energy stored in the capacitor at any one instant of time.

**Answer:** (a)  $100 \sin 50,000t \text{ V}$ ,  $t \geq 0$ ;  
(b) 150 W; (c) 3 mJ.

## 6.3 Series-Parallel Combinations of Inductance and Capacitance

Just as series-parallel combinations of resistors can be reduced to a single equivalent resistor, series-parallel combinations of inductors or capacitors can be reduced to a single inductor or capacitor. Figure 6.13 shows inductors in series. Here, the inductors are forced to carry the same current; thus we define only one current for the series combination. The voltage drops across the individual inductors are

$$v_1 = L_1 \frac{di}{dt}, \quad v_2 = L_2 \frac{di}{dt}, \quad \text{and} \quad v_3 = L_3 \frac{di}{dt}.$$

The voltage across the series connection is

$$v = v_1 + v_2 + v_3 = (L_1 + L_2 + L_3) \frac{di}{dt},$$

from which it should be apparent that the equivalent inductance of series-connected inductors is the sum of the individual inductances. For  $n$  inductors in series,

$$L_{\text{eq}} = L_1 + L_2 + L_3 + \cdots + L_n. \quad (6.19)$$

If the original inductors carry an initial current of  $i(t_0)$ , the equivalent inductor carries the same initial current. Figure 6.14 shows the equivalent circuit for series inductors carrying an initial current.

Inductors in parallel have the same terminal voltage. In the equivalent circuit, the current in each inductor is a function of the terminal voltage and the initial current in the inductor. For the three inductors in parallel shown in Fig. 6.15, the currents for the individual inductors are

$$\begin{aligned} i_1 &= \frac{1}{L_1} \int_{t_0}^t v \, d\tau + i_1(t_0), \\ i_2 &= \frac{1}{L_2} \int_{t_0}^t v \, d\tau + i_2(t_0), \\ i_3 &= \frac{1}{L_3} \int_{t_0}^t v \, d\tau + i_3(t_0). \end{aligned} \quad (6.20)$$

The current at the terminals of the three parallel inductors is the sum of the inductor currents:

$$i = i_1 + i_2 + i_3. \quad (6.21)$$

Substituting Eq. 6.20 into Eq. 6.21 yields

$$i = \left( \frac{1}{L_1} + \frac{1}{L_2} + \frac{1}{L_3} \right) \int_{t_0}^t v \, d\tau + i_1(t_0) + i_2(t_0) + i_3(t_0). \quad (6.22)$$

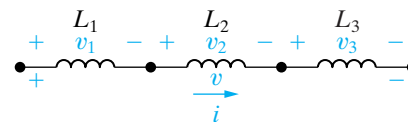


Figure 6.13 ▲ Inductors in series.

### ◀ Combining inductors in series

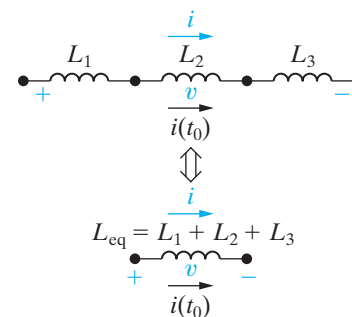


Figure 6.14 ▲ An equivalent circuit for inductors in series carrying an initial current  $i(t_0)$ .

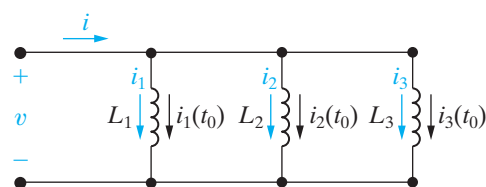


Figure 6.15 ▲ Three inductors in parallel.

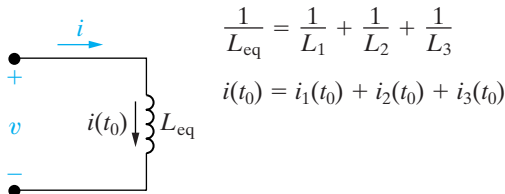
Now we can interpret Eq. 6.22 in terms of a single inductor; that is,

$$i = \frac{1}{L_{\text{eq}}} \int_{t_0}^t v \, d\tau + i(t_0). \quad (6.23)$$

Comparing Eq. 6.23 with (6.22) yields

$$\frac{1}{L_{\text{eq}}} = \frac{1}{L_1} + \frac{1}{L_2} + \frac{1}{L_3} \quad (6.24)$$

$$i(t_0) = i_1(t_0) + i_2(t_0) + i_3(t_0). \quad (6.25)$$



**Figure 6.16** ▲ An equivalent circuit for three inductors in parallel.

Figure 6.16 shows the equivalent circuit for the three parallel inductors in Fig. 6.15.

The results expressed in Eqs. 6.24 and 6.25 can be extended to  $n$  inductors in parallel:

**Combining inductors in parallel** ►

$$\frac{1}{L_{\text{eq}}} = \frac{1}{L_1} + \frac{1}{L_2} + \cdots + \frac{1}{L_n} \quad (6.26)$$

**Equivalent inductance initial current** ►

$$i(t_0) = i_1(t_0) + i_2(t_0) + \cdots + i_n(t_0). \quad (6.27)$$

Capacitors connected in series can be reduced to a single equivalent capacitor. The reciprocal of the equivalent capacitance is equal to the sum of the reciprocals of the individual capacitances. If each capacitor carries its own initial voltage, the initial voltage on the equivalent capacitor is the algebraic sum of the initial voltages on the individual capacitors. Figure 6.17 and the following equations summarize these observations:

**Combining capacitors in series** ►

$$\frac{1}{C_{\text{eq}}} = \frac{1}{C_1} + \frac{1}{C_2} + \cdots + \frac{1}{C_n}, \quad (6.28)$$

**Equivalent capacitance initial voltage** ►

$$v(t_0) = v_1(t_0) + v_2(t_0) + \cdots + v_n(t_0). \quad (6.29)$$

We leave the derivation of the equivalent circuit for series-connected capacitors as an exercise. (See Problem 6.32.)

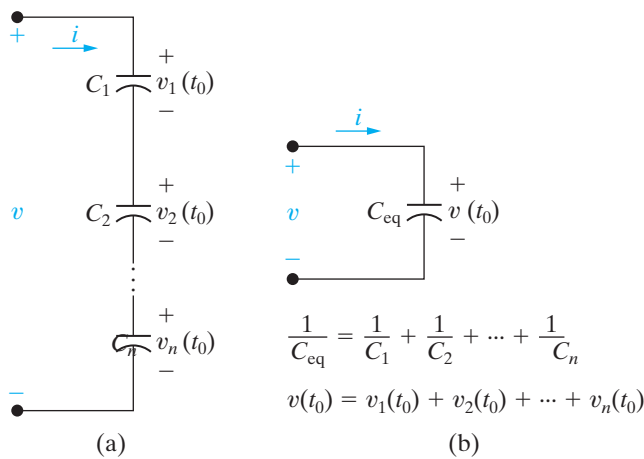
The equivalent capacitance of capacitors connected in parallel is simply the sum of the capacitances of the individual capacitors, as Fig. 6.18 and the following equation show:

**Combining capacitors in parallel** ►

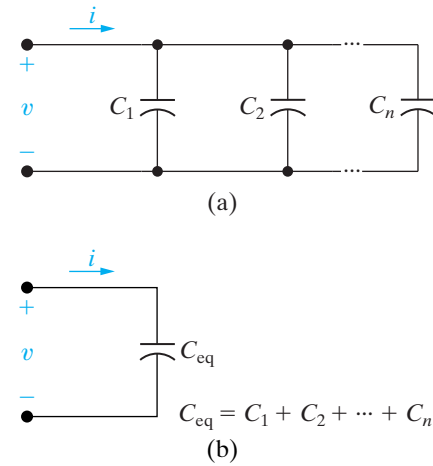
$$C_{\text{eq}} = C_1 + C_2 + \cdots + C_n. \quad (6.30)$$

Capacitors connected in parallel must carry the same voltage. Therefore, if there is an initial voltage across the original parallel capacitors, this same initial voltage appears across the equivalent capacitance  $C_{\text{eq}}$ . The derivation of the equivalent circuit for parallel capacitors is left as an exercise. (See Problem 6.33.)

We say more about series-parallel equivalent circuits of inductors and capacitors in Chapter 7, where we interpret results based on their use.



**Figure 6.17** ▲ An equivalent circuit for capacitors connected in series. (a) The series capacitors. (b) The equivalent circuit.



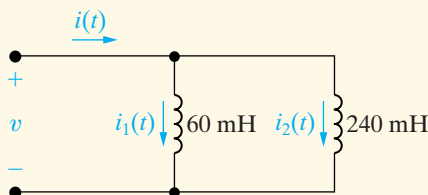
**Figure 6.18** ▲ An equivalent circuit for capacitors connected in parallel. (a) Capacitors in parallel. (b) The equivalent circuit.

## ASSESSMENT PROBLEMS

**Objective 3—Be able to combine inductors or capacitors in series and in parallel to form a single equivalent inductor**

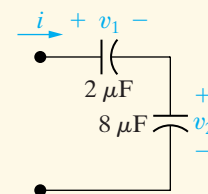
**6.4** The initial values of  $i_1$  and  $i_2$  in the circuit shown are  $+3\text{ A}$  and  $-5\text{ A}$ , respectively. The voltage at the terminals of the parallel inductors for  $t \geq 0$  is  $-30e^{-5t}\text{ mV}$ .

- If the parallel inductors are replaced by a single inductor, what is its inductance?
- What is the initial current and its reference direction in the equivalent inductor?
- Use the equivalent inductor to find  $i(t)$ .
- Find  $i_1(t)$  and  $i_2(t)$ . Verify that the solutions for  $i_1(t)$ ,  $i_2(t)$ , and  $i(t)$  satisfy Kirchhoff's current law.



- Answer:**
- 48 mH;
  - 2 A, up;
  - $0.125e^{-5t} - 2.125\text{ A}, t \geq 0$ ;
  - $i_1(t) = 0.1e^{-5t} + 2.9\text{ A}, t \geq 0$ ,  
 $i_2(t) = 0.025e^{-5t} - 5.025\text{ A}, t \geq 0$ .

**6.5** The current at the terminals of the two capacitors shown is  $240e^{-10t}\mu\text{A}$  for  $t \geq 0$ . The initial values of  $v_1$  and  $v_2$  are  $-10\text{ V}$  and  $-5\text{ V}$ , respectively. Calculate the total energy trapped in the capacitors as  $t \rightarrow \infty$ . (*Hint: Don't combine the capacitors in series—find the energy trapped in each, and then add.*)



**Answer:**  $20\mu\text{J}$ .

*NOTE: Also try Chapter Problems 6.22, 6.24, 6.27, and 6.31.*

## 6.4 Mutual Inductance

The magnetic field we considered in our study of inductors in Section 6.1 was restricted to a single circuit. We said that inductance is the parameter that relates a voltage to a time-varying current in the same circuit; thus, inductance is more precisely referred to as self-inductance.

We now consider the situation in which two circuits are linked by a magnetic field. In this case, the voltage induced in the second circuit can be related to the time-varying current in the first circuit by a parameter

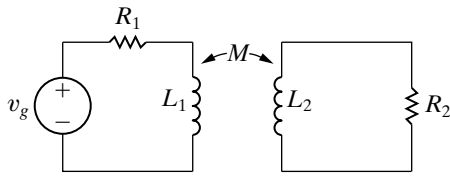


Figure 6.19 ▲ Two magnetically coupled coils.

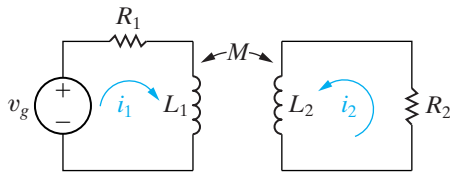


Figure 6.20 ▲ Coil currents  $i_1$  and  $i_2$  used to describe the circuit shown in Fig. 6.19.

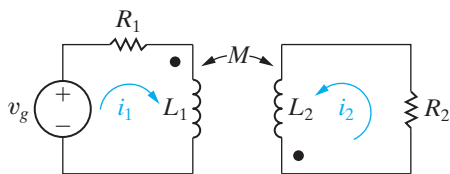


Figure 6.21 ▲ The circuit of Fig. 6.20 with dots added to the coils indicating the polarity of the mutually induced voltages.

### Dot convention for mutually coupled coils ►

#### Dot convention for mutually coupled coils (alternate) ►

known as mutual inductance. The circuit shown in Fig. 6.19 represents two magnetically coupled coils. The self-inductances of the two coils are labeled  $L_1$  and  $L_2$ , and the mutual inductance is labeled  $M$ . The double-headed arrow adjacent to  $M$  indicates the pair of coils with this value of mutual inductance. This notation is needed particularly in circuits containing more than one pair of magnetically coupled coils.

The easiest way to analyze circuits containing mutual inductance is to use mesh currents. The problem is to write the circuit equations that describe the circuit in terms of the coil currents. First, choose the reference direction for each coil current. Figure 6.20 shows arbitrarily selected reference currents. After choosing the reference directions for  $i_1$  and  $i_2$ , sum the voltages around each closed path. Because of the mutual inductance  $M$ , there will be two voltages across each coil, namely, a self-induced voltage and a mutually induced voltage. The self-induced voltage is the product of the self-inductance of the coil and the first derivative of the current in that coil. The mutually induced voltage is the product of the mutual inductance of the coils and the first derivative of the current in the other coil. Consider the coil on the left in Fig. 6.20 whose self-inductance has the value  $L_1$ . The self-induced voltage across this coil is  $L_1(di_1/dt)$  and the mutually induced voltage across this coil is  $M(di_2/dt)$ . But what about the polarities of these two voltages?

Using the passive sign convention, the self-induced voltage is a voltage drop in the direction of the current producing the voltage. But the polarity of the mutually induced voltage depends on the way the coils are wound in relation to the reference direction of coil currents. In general, showing the details of mutually coupled windings is very cumbersome. Instead, we keep track of the polarities by a method known as the **dot convention**, in which a dot is placed on one terminal of each winding, as shown in Fig. 6.21. These dots carry the sign information and allow us to draw the coils schematically rather than showing how they wrap around a core structure.

The rule for using the dot convention to determine the polarity of mutually induced voltage can be summarized as follows:

When the reference direction for a current enters the dotted terminal of a coil, the reference polarity of the voltage that it induces in the other coil is positive at its dotted terminal.

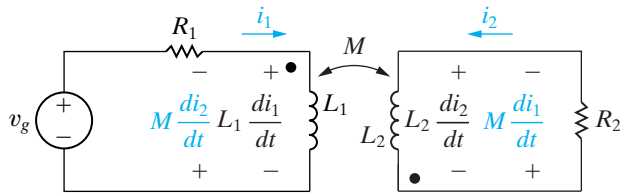
Or, stated alternatively,

When the reference direction for a current leaves the dotted terminal of a coil, the reference polarity of the voltage that it induces in the other coil is negative at its dotted terminal.

For the most part, dot markings will be provided for you in the circuit diagrams in this text. The important skill is to be able to write the appropriate circuit equations given your understanding of mutual inductance and the dot convention. Figuring out where to place the polarity dots if they are not given may be possible by examining the physical configuration of an actual circuit or by testing it in the laboratory. We will discuss these procedures after we discuss the use of dot markings.

In Fig. 6.21, the dot convention rule indicates that the reference polarity for the voltage induced in coil 1 by the current  $i_2$  is negative at the dotted terminal of coil 1. This voltage ( $Mdi_2/dt$ ) is a voltage rise with respect to  $i_1$ . The voltage induced in coil 2 by the current  $i_1$  is  $Mdi_1/dt$ , and its reference polarity is positive at the dotted terminal of coil 2. This voltage is a voltage rise in the direction of  $i_2$ . Figure 6.22 shows the self- and mutually induced voltages across coils 1 and 2 along with their polarity marks.





**Figure 6.22** ▲ The self- and mutually induced voltages appearing across the coils shown in Fig. 6.21.

Now let's look at the sum of the voltages around each closed loop. In Eqs. 6.31 and 6.32, voltage rises in the reference direction of a current are negative:

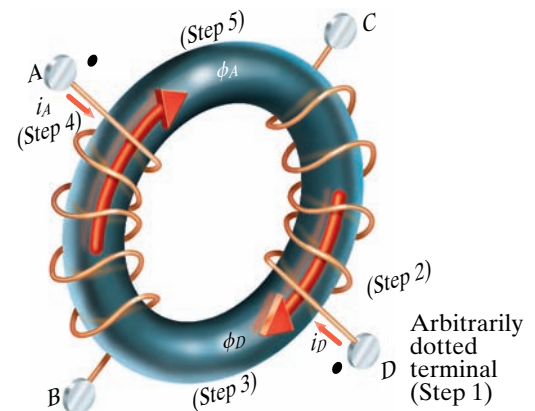
$$-v_g + i_1 R_1 + L_1 \frac{di_1}{dt} - M \frac{di_2}{dt} = 0, \quad (6.31)$$

$$i_2 R_2 + L_2 \frac{di_2}{dt} - M \frac{di_1}{dt} = 0. \quad (6.32)$$

### The Procedure for Determining Dot Markings

We shift now to two methods of determining dot markings. The first assumes that we know the physical arrangement of the two coils and the mode of each winding in a magnetically coupled circuit. The following six steps, applied here to Fig. 6.23, determine a set of dot markings:

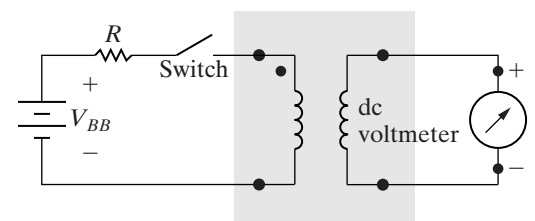
- Arbitrarily select one terminal—say, the D terminal—of one coil and mark it with a dot.
- Assign a current into the dotted terminal and label it  $i_D$ .
- Use the right-hand rule<sup>1</sup> to determine the direction of the magnetic field established by  $i_D$  inside the coupled coils and label this field  $\phi_D$ .
- Arbitrarily pick one terminal of the second coil—say, terminal A—and assign a current into this terminal, showing the current as  $i_A$ .
- Use the right-hand rule to determine the direction of the flux established by  $i_A$  inside the coupled coils and label this flux  $\phi_A$ .
- Compare the directions of the two fluxes  $\phi_D$  and  $\phi_A$ . If the fluxes have the same reference direction, place a dot on the terminal of the second coil where the test current ( $i_A$ ) enters. (In Fig. 6.23, the fluxes  $\phi_D$  and  $\phi_A$  have the same reference direction, and therefore a dot goes on terminal A.) If the fluxes have different reference directions, place a dot on the terminal of the second coil where the test current leaves.



**Figure 6.23** ▲ A set of coils showing a method for determining a set of dot markings.

The relative polarities of magnetically coupled coils can also be determined experimentally. This capability is important because in some situations, determining how the coils are wound on the core is impossible. One experimental method is to connect a dc voltage source, a resistor, a switch, and a dc voltmeter to the pair of coils, as shown in Fig. 6.24. The shaded box covering the coils implies that physical inspection of the coils is not possible. The resistor  $R$  limits the magnitude of the current supplied by the dc voltage source.

The coil terminal connected to the positive terminal of the dc source via the switch and limiting resistor receives a polarity mark, as shown in Fig. 6.24. When the switch is closed, the voltmeter deflection is observed. If the momentary deflection is upscale, the coil terminal connected to the positive terminal of the voltmeter receives the polarity mark. If the



**Figure 6.24** ▲ An experimental setup for determining polarity marks.

<sup>1</sup> See discussion of Faraday's law on page 193.

deflection is downscale, the coil terminal connected to the negative terminal of the voltmeter receives the polarity mark.

Example 6.6 shows how to use the dot markings to formulate a set of circuit equations in a circuit containing magnetically coupled coils.

**Example 6.6** Finding Mesh-Current Equations for a Circuit with Magnetically Coupled Coils

- a) Write a set of mesh-current equations that describe the circuit in Fig. 6.25 in terms of the currents  $i_1$  and  $i_2$ .
- b) Verify that if there is no energy stored in the circuit at  $t = 0$  and if  $i_g = 16 - 16e^{-5t}$  A, the solutions for  $i_1$  and  $i_2$  are

$$i_1 = 4 + 64e^{-5t} - 68e^{-4t} \text{ A,}$$

$$i_2 = 1 - 52e^{-5t} + 51e^{-4t} \text{ A.}$$

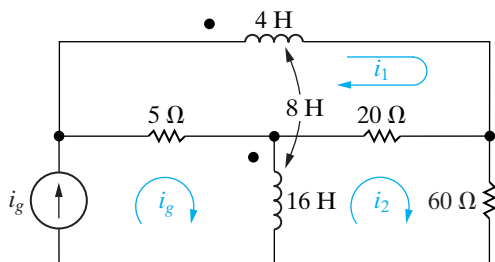


Figure 6.25 ▲ The circuit for Example 6.6.

**Solution**

- a) Summing the voltages around the  $i_1$  mesh yields

$$4 \frac{di_1}{dt} + 8 \frac{d}{dt}(i_g - i_2) + 20(i_1 - i_2) + 5(i_1 - i_g) = 0.$$

The  $i_2$  mesh equation is

$$20(i_2 - i_1) + 60i_2 + 16 \frac{d}{dt}(i_2 - i_g) - 8 \frac{di_1}{dt} = 0.$$

Note that the voltage across the 4 H coil due to the current  $(i_g - i_2)$ , that is,  $8d(i_g - i_2)/dt$ , is a voltage drop in the direction of  $i_1$ . The voltage induced in the 16 H coil by the current  $i_1$ , that is,  $8di_1/dt$ , is a voltage rise in the direction of  $i_2$ .

- b) To check the validity of  $i_1$  and  $i_2$ , we begin by testing the initial and final values of  $i_1$  and  $i_2$ . We know by hypothesis that  $i_1(0) = i_2(0) = 0$ . From the given solutions we have

$$i_1(0) = 4 + 64 - 68 = 0,$$

$$i_2(0) = 1 - 52 + 51 = 0.$$

Now we observe that as  $t$  approaches infinity the source current ( $i_g$ ) approaches a constant value of 16 A, and therefore the magnetically coupled coils behave as short circuits. Hence at  $t = \infty$  the circuit reduces to that shown in Fig. 6.26. From Fig. 6.26 we see that at  $t = \infty$  the three resistors are in parallel across the 16 A source. The equivalent resistance is 3.75  $\Omega$  and thus the voltage across the 16 A current source is 60 V. It follows that

$$i_1(\infty) = \frac{60}{20} + \frac{60}{60} = 4 \text{ A,}$$

$$i_2(\infty) = \frac{60}{60} = 1 \text{ A.}$$

These values agree with the final values predicted by the solutions for  $i_1$  and  $i_2$ .

Finally we check the solutions by seeing if they satisfy the differential equations derived in (a). We will leave this final check to the reader via Problem 6.37.

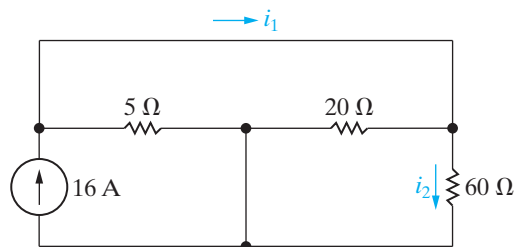


Figure 6.26 ▲ The circuit of Example 6.6 when  $t = \infty$ .

## ✓ ASSESSMENT PROBLEM

**Objective 4—Use the dot convention to write mesh-current equations for mutually coupled coils**

- 6.6** a) Write a set of mesh-current equations for the circuit in Example 6.6 if the dot on the 4 H inductor is at the right-hand terminal, the reference direction of  $i_g$  is reversed, and the 60  $\Omega$  resistor is increased to 780  $\Omega$ .
- b) Verify that if there is no energy stored in the circuit at  $t = 0$ , and if  $i_g = 1.96 - 1.96e^{-4t}$  A, the solutions to the differential equations derived in (a) of this Assessment Problem are

$$i_1 = -0.4 - 11.6e^{-4t} + 12e^{-5t} \text{ A,}$$

$$i_2 = -0.01 - 0.99e^{-4t} + e^{-5t} \text{ A.}$$

*NOTE: Also try Chapter Problem 6.39.*

- Answer:** (a)  $4(di_1/dt) + 25i_1 + 8(di_2/dt) - 20i_2$   
 $= -5i_g - 8(di_g/dt)$   
 and  
 $8(di_1/dt) - 20i_1 + 16(di_2/dt) + 800i_2$   
 $= -16(di_g/dt);$   
 (b) verification.

## 6.5 A Closer Look at Mutual Inductance

In order to fully explain the circuit parameter mutual inductance, and to examine the limitations and assumptions made in the qualitative discussion presented in Section 6.4, we begin with a more quantitative description of self-inductance than was previously provided.

### A Review of Self-Inductance

The concept of inductance can be traced to Michael Faraday, who did pioneering work in this area in the early 1800s. Faraday postulated that a magnetic field consists of lines of force surrounding the current-carrying conductor. Visualize these lines of force as energy-storing elastic bands that close on themselves. As the current increases and decreases, the elastic bands (that is, the lines of force) spread and collapse about the conductor. The voltage induced in the conductor is proportional to the number of lines that collapse into, or cut, the conductor. This image of induced voltage is expressed by what is called Faraday's law; that is,

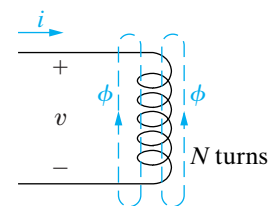
$$v = \frac{d\lambda}{dt}, \quad (6.33)$$

where  $\lambda$  is referred to as the flux linkage and is measured in weber-turns.

How do we get from Faraday's law to the definition of inductance presented in Section 6.1? We can begin to draw this connection using Fig. 6.27 as a reference.

The lines threading the  $N$  turns and labeled  $\phi$  represent the magnetic lines of force that make up the magnetic field. The strength of the magnetic field depends on the strength of the current, and the spatial orientation of the field depends on the direction of the current. The right-hand rule relates the orientation of the field to the direction of the current: When the fingers of the right hand are wrapped around the coil so that the fingers point in the direction of the current, the thumb points in the direction of that portion of the magnetic field inside the coil. The flux linkage is the product of the magnetic field ( $\phi$ ), measured in webers (Wb), and the number of turns linked by the field ( $N$ ):

$$\lambda = N\phi. \quad (6.34)$$



**Figure 6.27** ▲ Representation of a magnetic field linking an  $N$ -turn coil.

The magnitude of the flux,  $\phi$ , is related to the magnitude of the coil current by the relationship

$$\phi = \mathcal{P}Ni, \quad (6.35)$$

where  $N$  is the number of turns on the coil, and  $\mathcal{P}$  is the permeance of the space occupied by the flux. Permeance is a quantity that describes the magnetic properties of this space, and as such, a detailed discussion of permeance is outside the scope of this text. Here, we need only observe that, when the space containing the flux is made up of magnetic materials (such as iron, nickel, and cobalt), the permeance varies with the flux, giving a nonlinear relationship between  $\phi$  and  $i$ . But when the space containing the flux is comprised of nonmagnetic materials, the permeance is constant, giving a linear relationship between  $\phi$  and  $i$ . Note from Eq. 6.35 that the flux is also proportional to the number of turns on the coil.

Here, we assume that the core material—the space containing the flux—is nonmagnetic. Then, substituting Eqs. 6.34 and 6.35 into Eq. 6.33 yields

$$\begin{aligned} v &= \frac{d\lambda}{dt} = \frac{d(N\phi)}{dt} \\ &= N \frac{d\phi}{dt} = N \frac{d}{dt}(\mathcal{P}Ni) \\ &= N^2 \mathcal{P} \frac{di}{dt} = L \frac{di}{dt}, \end{aligned} \quad (6.36)$$

which shows that self-inductance is proportional to the square of the number of turns on the coil. We make use of this observation later.

The polarity of the induced voltage in the circuit in Fig. 6.27 reflects the reaction of the field to the current creating the field. For example, when  $i$  is increasing,  $di/dt$  is positive and  $v$  is positive. Thus energy is required to establish the magnetic field. The product  $vi$  gives the rate at which energy is stored in the field. When the field collapses,  $di/dt$  is negative, and again the polarity of the induced voltage is in opposition to the change. As the field collapses about the coil, energy is returned to the circuit.

Keeping in mind this further insight into the concept of self-inductance, we now turn back to mutual inductance.

## The Concept of Mutual Inductance

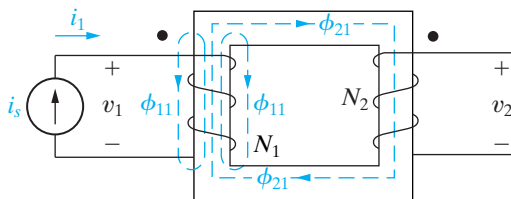


Figure 6.28 ▲ Two magnetically coupled coils.

Figure 6.28 shows two magnetically coupled coils. You should verify that the dot markings on the two coils agree with the direction of the coil windings and currents shown. The number of turns on each coil are  $N_1$  and  $N_2$ , respectively. Coil 1 is energized by a time-varying current source that establishes the current  $i_1$  in the  $N_1$  turns. Coil 2 is not energized and is open. The coils are wound on a nonmagnetic core. The flux produced by the current  $i_1$  can be divided into two components, labeled  $\phi_{11}$  and  $\phi_{21}$ . The flux component  $\phi_{11}$  is the flux produced by  $i_1$  that links only the  $N_1$  turns. The component  $\phi_{21}$  is the flux produced by  $i_1$  that links the  $N_2$  turns and the  $N_1$  turns. The first digit in the subscript to the flux gives the coil number, and the second digit refers to the coil current. Thus  $\phi_{11}$  is a flux linking coil 1 and produced by a current in coil 1, whereas  $\phi_{21}$  is a flux linking coil 2 and produced by a current in coil 1.

The total flux linking coil 1 is  $\phi_1$ , the sum of  $\phi_{11}$  and  $\phi_{21}$ :

$$\phi_1 = \phi_{11} + \phi_{21}. \quad (6.37)$$

The flux  $\phi_1$  and its components  $\phi_{11}$  and  $\phi_{21}$  are related to the coil current  $i_1$  as follows:

$$\phi_1 = \mathcal{P}_1 N_1 i_1, \quad (6.38)$$

$$\phi_{11} = \mathcal{P}_{11} N_1 i_1, \quad (6.39)$$

$$\phi_{21} = \mathcal{P}_{21} N_1 i_1, \quad (6.40)$$

where  $\mathcal{P}_1$  is the permeance of the space occupied by the flux  $\phi_1$ ,  $\mathcal{P}_{11}$  is the permeance of the space occupied by the flux  $\phi_{11}$ , and  $\mathcal{P}_{21}$  is the permeance of the space occupied by the flux  $\phi_{21}$ . Substituting Eqs. 6.38, 6.39, and 6.40 into Eq. 6.37 yields the relationship between the permeance of the space occupied by the total flux  $\phi_1$  and the permeances of the spaces occupied by its components  $\phi_{11}$  and  $\phi_{21}$ :

$$\mathcal{P}_1 = \mathcal{P}_{11} + \mathcal{P}_{21}. \quad (6.41)$$

We use Faraday's law to derive expressions for  $v_1$  and  $v_2$ :

$$\begin{aligned} v_1 &= \frac{d\lambda_1}{dt} = \frac{d(N_1\phi_1)}{dt} = N_1 \frac{d}{dt}(\phi_{11} + \phi_{21}) \\ &= N_1^2(\mathcal{P}_{11} + \mathcal{P}_{21}) \frac{di_1}{dt} = N_1^2 \mathcal{P}_1 \frac{di_1}{dt} = L_1 \frac{di_1}{dt}, \end{aligned} \quad (6.42)$$

and

$$\begin{aligned} v_2 &= \frac{d\lambda_2}{dt} = \frac{d(N_2\phi_{21})}{dt} = N_2 \frac{d}{dt}(\mathcal{P}_{21} N_1 i_1) \\ &= N_2 N_1 \mathcal{P}_{21} \frac{di_1}{dt}. \end{aligned} \quad (6.43)$$

The coefficient of  $di_1/dt$  in Eq. 6.42 is the self-inductance of coil 1. The coefficient of  $di_1/dt$  in Eq. 6.43 is the mutual inductance between coils 1 and 2. Thus

$$M_{21} = N_2 N_1 \mathcal{P}_{21}. \quad (6.44)$$

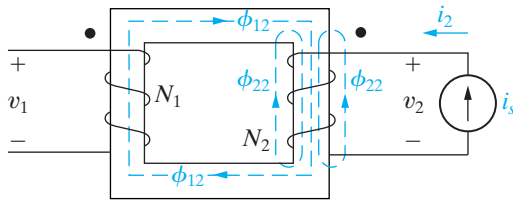
The subscript on  $M$  specifies an inductance that relates the voltage induced in coil 2 to the current in coil 1.

The coefficient of mutual inductance gives

$$v_2 = M_{21} \frac{di_1}{dt}. \quad (6.45)$$

Note that the dot convention is used to assign the polarity reference to  $v_2$  in Fig. 6.28.

For the coupled coils in Fig. 6.28, exciting coil 2 from a time-varying current source ( $i_2$ ) and leaving coil 1 open produces the circuit arrangement



**Figure 6.29** ▲ The magnetically coupled coils of Fig. 6.28, with coil 2 excited and coil 1 open.

shown in Fig. 6.29. Again, the polarity reference assigned to  $v_1$  is based on the dot convention.

The total flux linking coil 2 is

$$\phi_2 = \phi_{22} + \phi_{12}. \quad (6.46)$$

The flux  $\phi_2$  and its components  $\phi_{22}$  and  $\phi_{12}$  are related to the coil current  $i_2$  as follows:

$$\phi_2 = \mathcal{P}_2 N_2 i_2, \quad (6.47)$$

$$\phi_{22} = \mathcal{P}_{22} N_2 i_2, \quad (6.48)$$

$$\phi_{12} = \mathcal{P}_{12} N_2 i_2. \quad (6.49)$$

The voltages  $v_2$  and  $v_1$  are

$$v_2 = \frac{d\lambda_2}{dt} = N_2^2 \mathcal{P}_2 \frac{di_2}{dt} = L_2 \frac{di_2}{dt}, \quad (6.50)$$

$$v_1 = \frac{d\lambda_1}{dt} = \frac{d}{dt}(N_1 \phi_{12}) = N_1 N_2 \mathcal{P}_{12} \frac{di_2}{dt}. \quad (6.51)$$

The coefficient of mutual inductance that relates the voltage induced in coil 1 to the time-varying current in coil 2 is the coefficient of  $di_2/dt$  in Eq. 6.51:

$$M_{12} = N_1 N_2 \mathcal{P}_{12}. \quad (6.52)$$

For nonmagnetic materials, the permeances  $\mathcal{P}_{12}$  and  $\mathcal{P}_{21}$  are equal, and therefore

$$M_{12} = M_{21} = M. \quad (6.53)$$

Hence for linear circuits with just two magnetically coupled coils, attaching subscripts to the coefficient of mutual inductance is not necessary.

### Mutual Inductance in Terms of Self-Inductance

The value of mutual inductance is a function of the self-inductances. We derive this relationship as follows. From Eqs. 6.42 and 6.50,

$$L_1 = N_1^2 \mathcal{P}_1, \quad (6.54)$$

$$L_2 = N_2^2 \mathcal{P}_2, \quad (6.55)$$

respectively. From Eqs. 6.54 and 6.55,

$$L_1 L_2 = N_1^2 N_2^2 \mathcal{P}_1 \mathcal{P}_2. \quad (6.56)$$

We now use Eq. 6.41 and the corresponding expression for  $\mathcal{P}_2$  to write

$$L_1 L_2 = N_1^2 N_2^2 (\mathcal{P}_{11} + \mathcal{P}_{21})(\mathcal{P}_{22} + \mathcal{P}_{12}). \quad (6.57)$$

But for a linear system,  $\mathcal{P}_{21} = \mathcal{P}_{12}$ , so Eq. 6.57 becomes

$$\begin{aligned} L_1 L_2 &= (N_1 N_2 \mathcal{P}_{12})^2 \left(1 + \frac{\mathcal{P}_{11}}{\mathcal{P}_{12}}\right) \left(1 + \frac{\mathcal{P}_{22}}{\mathcal{P}_{12}}\right) \\ &= M^2 \left(1 + \frac{\mathcal{P}_{11}}{\mathcal{P}_{12}}\right) \left(1 + \frac{\mathcal{P}_{22}}{\mathcal{P}_{12}}\right). \end{aligned} \quad (6.58)$$

Replacing the two terms involving permeances by a single constant expresses Eq. 6.58 in a more meaningful form:

$$\frac{1}{k^2} = \left(1 + \frac{\mathcal{P}_{11}}{\mathcal{P}_{12}}\right) \left(1 + \frac{\mathcal{P}_{22}}{\mathcal{P}_{12}}\right). \quad (6.59)$$

Substituting Eq. 6.59 into Eq. 6.58 yields

$$M^2 = k^2 L_1 L_2$$

or

$$M = k \sqrt{L_1 L_2}, \quad (6.60)$$

◀ Relating self-inductances and mutual inductance using coupling coefficient

where the constant  $k$  is called the **coefficient of coupling**. According to Eq. 6.59,  $1/k^2$  must be greater than 1, which means that  $k$  must be less than 1. In fact, the coefficient of coupling must lie between 0 and 1, or

$$0 \leq k \leq 1. \quad (6.61)$$

The coefficient of coupling is 0 when the two coils have no common flux; that is, when  $\phi_{12} = \phi_{21} = 0$ . This condition implies that  $\mathcal{P}_{12} = 0$ , and Eq. 6.59 indicates that  $1/k^2 = \infty$ , or  $k = 0$ . If there is no flux linkage between the coils, obviously  $M$  is 0.

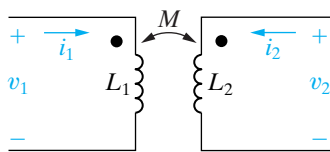
The coefficient of coupling is equal to 1 when  $\phi_{11}$  and  $\phi_{22}$  are 0. This condition implies that all the flux that links coil 1 also links coil 2. In terms of Eq. 6.59,  $\mathcal{P}_{11} = \mathcal{P}_{22} = 0$ , which obviously represents an ideal state; in reality, winding two coils so that they share precisely the same flux is physically impossible. Magnetic materials (such as alloys of iron, cobalt, and nickel) create a space with high permeance and are used to establish coefficients of coupling that approach unity. (We say more about this important quality of magnetic materials in Chapter 9.)

*NOTE:* Assess your understanding of this material by trying Chapter Problems 6.46 and 6.50.

## Energy Calculations

We conclude our first look at mutual inductance with a discussion of the total energy stored in magnetically coupled coils. In doing so, we will confirm two observations made earlier: For linear magnetic coupling, (1)  $M_{12} = M_{21} = M$ , and (2)  $M = k \sqrt{L_1 L_2}$ , where  $0 \leq k \leq 1$ .





**Figure 6.30** ▲ The circuit used to derive the basic energy relationships.

We use the circuit shown in Fig. 6.30 to derive the expression for the total energy stored in the magnetic fields associated with a pair of linearly coupled coils. We begin by assuming that the currents  $i_1$  and  $i_2$  are zero and that this zero-current state corresponds to zero energy stored in the coils. Then we let  $i_1$  increase from zero to some arbitrary value  $I_1$  and compute the energy stored when  $i_1 = I_1$ . Because  $i_2 = 0$ , the total power input into the pair of coils is  $v_1 i_1$ , and the energy stored is

$$\int_0^{W_1} dw = L_1 \int_0^{I_1} i_1 di_1,$$

$$W_1 = \frac{1}{2} L_1 I_1^2. \quad (6.62)$$

Now we hold  $i_1$  constant at  $I_1$  and increase  $i_2$  from zero to some arbitrary value  $I_2$ . During this time interval, the voltage induced in coil 2 by  $i_1$  is zero because  $I_1$  is constant. The voltage induced in coil 1 by  $i_2$  is  $M_{12} di_2/dt$ . Therefore, the power input to the pair of coils is

$$p = I_1 M_{12} \frac{di_2}{dt} + i_2 v_2.$$

The total energy stored in the pair of coils when  $i_2 = I_2$  is

$$\int_{W_1}^W dw = \int_0^{I_2} I_1 M_{12} di_2 + \int_0^{I_2} L_2 i_2 di_2,$$

or

$$\begin{aligned} W &= W_1 + I_1 I_2 M_{12} + \frac{1}{2} L_2 I_2^2, \\ &= \frac{1}{2} L_1 I_1^2 + \frac{1}{2} L_2 I_2^2 + I_1 I_2 M_{12}. \end{aligned} \quad (6.63)$$

If we reverse the procedure—that is, if we first increase  $i_2$  from zero to  $I_2$  and then increase  $i_1$  from zero to  $I_1$ —the total energy stored is

$$W = \frac{1}{2} L_1 I_1^2 + \frac{1}{2} L_2 I_2^2 + I_1 I_2 M_{21}. \quad (6.64)$$

Equations 6.63 and 6.64 express the total energy stored in a pair of linearly coupled coils as a function of the coil currents, the self-inductances, and the mutual inductance. Note that the only difference between these equations is the coefficient of the current product  $I_1 I_2$ . We use Eq. 6.63 if  $i_1$  is established first and Eq. 6.64 if  $i_2$  is established first.

When the coupling medium is linear, the total energy stored is the same regardless of the order used to establish  $I_1$  and  $I_2$ . The reason is that in a linear coupling, the resultant magnetic flux depends only on the final values of  $i_1$  and  $i_2$ , not on how the currents reached their final values. If the resultant flux is the same, the stored energy is the same. Therefore, for linear coupling,  $M_{12} = M_{21}$ . Also, because  $I_1$  and  $I_2$  are arbitrary values of  $i_1$  and  $i_2$ , respectively, we represent the coil currents by their instantaneous values  $i_1$  and  $i_2$ . Thus, at any instant of time, the total energy stored in the coupled coils is

$$w(t) = \frac{1}{2}L_1i_1^2 + \frac{1}{2}L_2i_2^2 + Mi_1i_2. \quad (6.65)$$

We derived Eq. 6.65 by assuming that both coil currents entered polarity-marked terminals. We leave it to you to verify that, if one current enters a polarity-marked terminal while the other leaves such a terminal, the algebraic sign of the term  $Mi_1i_2$  reverses. Thus, in general,

$$w(t) = \frac{1}{2}L_1i_1^2 + \frac{1}{2}L_2i_2^2 \pm Mi_1i_2. \quad (6.66) \quad \blacktriangleleft \text{Energy stored in magnetically-coupled coils}$$

We use Eq. 6.66 to show that  $M$  cannot exceed  $\sqrt{L_1L_2}$ . The magnetically coupled coils are passive elements, so the total energy stored can never be negative. If  $w(t)$  can never be negative, Eq. 6.66 indicates that the quantity

$$\frac{1}{2}L_1i_1^2 + \frac{1}{2}L_2i_2^2 - Mi_1i_2$$

must be greater than or equal to zero when  $i_1$  and  $i_2$  are either both positive or both negative. The limiting value of  $M$  corresponds to setting the quantity equal to zero:

$$\frac{1}{2}L_1i_1^2 + \frac{1}{2}L_2i_2^2 - Mi_1i_2 = 0. \quad (6.67)$$

To find the limiting value of  $M$  we add and subtract the term  $i_1i_2\sqrt{L_1L_2}$  to the left-hand side of Eq. 6.67. Doing so generates a term that is a perfect square:

$$\left(\sqrt{\frac{L_1}{2}}i_1 - \sqrt{\frac{L_2}{2}}i_2\right)^2 + i_1i_2\left(\sqrt{L_1L_2} - M\right) = 0. \quad (6.68)$$

The squared term in Eq. 6.68 can never be negative, but it can be zero. Therefore  $w(t) \geq 0$  only if

$$\sqrt{L_1L_2} \geq M, \quad (6.69)$$

which is another way of saying that

$$M = k\sqrt{L_1 L_2} \quad (0 \leq k \leq 1).$$

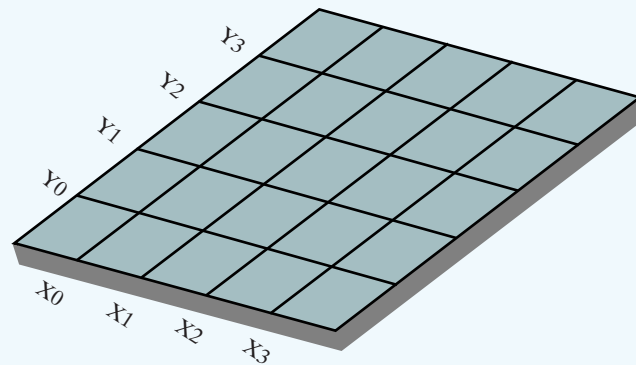
We derived Eq. 6.69 by assuming that  $i_1$  and  $i_2$  are either both positive or both negative. However, we get the same result if  $i_1$  and  $i_2$  are of opposite sign, because in this case we obtain the limiting value of  $M$  by selecting the plus sign in Eq. 6.66.

*NOTE: Assess your understanding of this material by trying Chapter Problems 6.47 and 6.48.*

## Practical Perspective

### Capacitive Touch Screens

Capacitive touch screens are often used in applications where two or more simultaneous touch points must be detected. We will discuss two designs for a multi-touch screen. The first design employs a grid of electrodes, as shown in Fig. 6.31. When energized, a small parasitic capacitance,  $C_p$ , exists between each electrode strip and ground, as shown in Fig. 6.32(a). When the screen is touched, say at the position  $x, y$  on the screen, a second capacitance exists due to the transfer of a small amount of charge from the screen to the human body, which acts like a conductor. The effect is to introduce a second capacitance at the point of touch with respect to ground, as shown in Fig. 6.32(b).

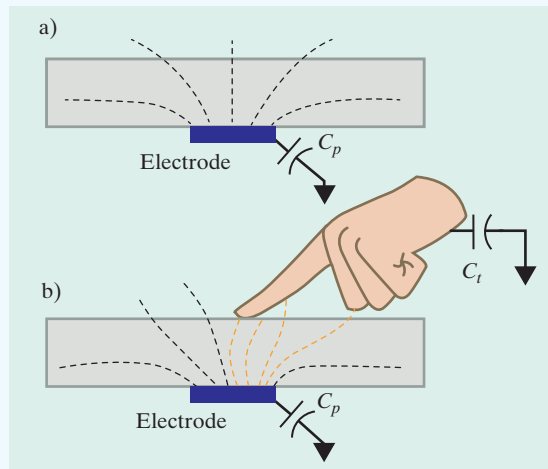


**Figure 6.31** ▲ Multi-touch screen with grid of electrodes.

The touchscreen controller is continually monitoring the capacitance between the electrodes in the grid and ground. If the screen is not being touched, the capacitance between every electrode in the  $x$ -grid and ground is  $C_p$ ; the same is true for the capacitance between every electrode in the  $y$ -grid and ground.

When the screen is touched at a single point,  $C_t$  and  $C_p$  combine in parallel. The equivalent capacitance between the  $x$ -grid electrode closest to the touch point and ground is now

$$C_{tx} = C_t + C_p.$$



**Figure 6.32** ▲ (a) Parasitic capacitance between electrode and ground with no touch; (b) Additional capacitance introduced by a touch.

Likewise, the equivalent capacitance between the  $y$ -grid electrode closest to the touch point and ground is now

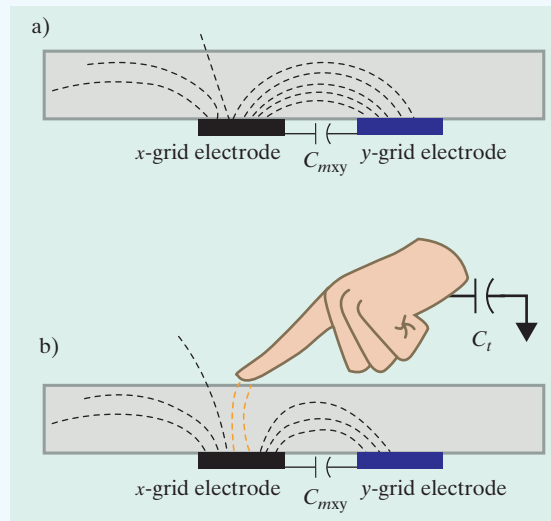
$$C_{iy} = C_t + C_p.$$

Thus, a screen touch increases the capacitance between the electrodes and ground for the  $x$ - and  $y$ -grid electrodes closest to the touch point.

Now consider what happens when there are two simultaneous points where the screen is touched. Assume that the first touch point has coordinates  $x_1, y_1$  and the second touch point has coordinates  $x_2, y_2$ . Now there are four screen locations that correspond to an increase in capacitance:  $x_1, y_1$ ;  $x_1, y_2$ ;  $x_2, y_1$ ; and  $x_2, y_2$ . Two of those screen locations match the two touch points, and the other two points are called “ghost” points, because the screen was not touched at those points. Therefore, this method for implementing a capacitive touch screen cannot accurately identify more than a single touch point.

Most modern capacitive touch screens do not use the “self-capacitance” design discussed above. Instead of measuring the capacitance between each  $x$ -grid electrode and ground, and each  $y$ -grid electrode and ground, the capacitance between each  $x$ -grid electrode and each  $y$ -grid electrode is measured. This capacitance is known as “mutual” capacitance and is shown in Fig. 6.33(a).

When the screen is touched, say at the position  $x, y$  on the screen, a second capacitance again exists due to the transfer of a small amount of charge from the screen to the human body. A second capacitance exists at the point of touch with respect to ground, as shown in Fig. 6.33(b). Therefore, whenever there is a change in the mutual capacitance,  $C_{mxy}$ , the screen touch point can be uniquely identified as  $x, y$ . If the screen is touched at the points  $x_1, y_1$  and  $x_2, y_2$  then there will be precisely two mutual capacitances that change:  $C_{mx_1y_1}$  and  $C_{mx_2y_2}$ . There are no “ghost”



**Figure 6.33** ▲ (a) Mutual capacitance between an x-grid and a y-grid electrode; (b) Additional capacitance introduced by a touch.

points identified, as there were in the self-capacitance design, so the mutual capacitance design truly produces a multi-touch screen capable of identifying two or more touch points uniquely and accurately.

*NOTE: Assess your understanding of the Practical Perspective by solving Chapter Problems 6.51–6.53.*

## Summary

- **Inductance** is a linear circuit parameter that relates the voltage induced by a time-varying magnetic field to the current producing the field. (See page 176.)
- **Capacitance** is a linear circuit parameter that relates the current induced by a time-varying electric field to the voltage producing the field. (See page 182.)
- Inductors and capacitors are passive elements; they can store and release energy, but they cannot generate or dissipate energy. (See page 176.)
- The instantaneous power at the terminals of an inductor or capacitor can be positive or negative, depending on whether energy is being delivered to or extracted from the element.
- An inductor:
  - does not permit an instantaneous change in its terminal current,
  - does permit an instantaneous change in its terminal voltage, and
  - behaves as a short circuit in the presence of a constant terminal current. (See page 188.)
- A capacitor:
  - does not permit an instantaneous change in its terminal voltage,
  - does permit an instantaneous change in its terminal current, and
  - behaves as an open circuit in the presence of a constant terminal voltage. (See page 183.)

- Equations for voltage, current, power, and energy in ideal inductors and capacitors are given in Table 6.1.
- Inductors in series or in parallel can be replaced by an equivalent inductor. Capacitors in series or in parallel can be replaced by an equivalent capacitor. The equations are summarized in Table 6.2. See Section 6.3 for a discussion on how to handle the initial conditions for series and parallel equivalent circuits involving inductors and capacitors.
- **Mutual inductance**,  $M$ , is the circuit parameter relating the voltage induced in one circuit to a time-varying current in another circuit. Specifically,

$$v_1 = L_1 \frac{di_1}{dt} + M_{12} \frac{di_2}{dt}$$

$$v_2 = M_{21} \frac{di_1}{dt} + L_2 \frac{di_2}{dt},$$

where  $v_1$  and  $i_1$  are the voltage and current in circuit 1, and  $v_2$  and  $i_2$  are the voltage and current in circuit 2. For coils wound on nonmagnetic cores,  $M_{12} = M_{21} = M$ . (See page 190.)

- The **dot convention** establishes the polarity of mutually induced voltages:

When the reference direction for a current enters the dotted terminal of a coil, the reference polarity of the voltage that it induces in the other coil is positive at its dotted terminal.

Or, alternatively,

When the reference direction for a current leaves the dotted terminal of a coil, the reference polarity of the voltage that it induces in the other coil is negative at its dotted terminal.

(See page 190.)

- The relationship between the self-inductance of each winding and the mutual inductance between windings is

$$M = k\sqrt{L_1L_2}.$$

The **coefficient of coupling**,  $k$ , is a measure of the degree of magnetic coupling. By definition,  $0 \leq k \leq 1$ . (See page 197.)

**TABLE 6.1 Terminal Equations for Ideal Inductors and Capacitors**

Inductors	
$v = L \frac{di}{dt}$	(V)
$i = \frac{1}{L} \int_{t_0}^t v \, d\tau + i(t_0)$	(A)
$p = vi = Li \frac{di}{dt}$	(W)
$w = \frac{1}{2} Li^2$	(J)
Capacitors	
$v = \frac{1}{C} \int_{t_0}^t i \, d\tau + v(t_0)$	(V)
$i = C \frac{dv}{dt}$	(A)
$p = vi = Cv \frac{dv}{dt}$	(W)
$w = \frac{1}{2} Cv^2$	(J)

**TABLE 6.2 Equations for Series- and Parallel-Connected Inductors and Capacitors**

Series-Connected	
$L_{eq} = L_1 + L_2 + \dots + L_n$	
$\frac{1}{C_{eq}} = \frac{1}{C_1} + \frac{1}{C_2} + \dots + \frac{1}{C_n}$	
Parallel-Connected	
$\frac{1}{L_{eq}} = \frac{1}{L_1} + \frac{1}{L_2} + \dots + \frac{1}{L_n}$	
$C_{eq} = C_1 + C_2 + \dots + C_n$	

- The energy stored in magnetically coupled coils in a linear medium is related to the coil currents and inductances by the relationship

$$w = \frac{1}{2} L_1 i_1^2 + \frac{1}{2} L_2 i_2^2 \pm M i_1 i_2.$$

(See page 199.)

## Problems

### Section 6.1

**6.1** The current in a  $150\ \mu\text{H}$  inductor is known to be

PSPICE  
MULTISIM

$$i_L = 25te^{-500t}\ \text{A} \quad \text{for } t \geq 0.$$

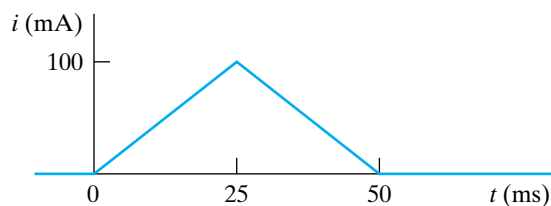
- Find the voltage across the inductor for  $t > 0$ . (Assume the passive sign convention.)
- Find the power (in microwatts) at the terminals of the inductor when  $t = 5\ \text{ms}$ .
- Is the inductor absorbing or delivering power at  $5\ \text{ms}$ ?
- Find the energy (in microjoules) stored in the inductor at  $5\ \text{ms}$ .
- Find the maximum energy (in microjoules) stored in the inductor and the time (in milliseconds) when it occurs.

**6.2** The triangular current pulse shown in Fig. P6.2 is applied to a  $500\ \text{mH}$  inductor.

PSPICE  
MULTISIM

- Write the expressions that describe  $i(t)$  in the four intervals  $t < 0$ ,  $0 \leq t \leq 25\ \text{ms}$ ,  $25\ \text{ms} \leq t \leq 50\ \text{ms}$ , and  $t > 50\ \text{ms}$ .
- Derive the expressions for the inductor voltage, power, and energy. Use the passive sign convention.

Figure P6.2



**6.3** The current in a  $50\ \text{mH}$  inductor is known to be

$$i = 120\ \text{mA}, \quad t \leq 0;$$

$$i = A_1e^{-500t} + A_2e^{-2000t}\ \text{A}, \quad t \geq 0.$$

The voltage across the inductor (passive sign convention) is  $3\ \text{V}$  at  $t = 0$ .

- Find the expression for the voltage across the inductor for  $t > 0$ .
- Find the time, greater than zero, when the power at the terminals of the inductor is zero.

**6.4** Assume in Problem 6.3 that the value of the voltage across the inductor at  $t = 0$  is  $-18\ \text{V}$  instead of  $3\ \text{V}$ .

- Find the numerical expressions for  $i$  and  $v$  for  $t \geq 0$ .
- Specify the time intervals when the inductor is storing energy and the time intervals when the inductor is delivering energy.
- Show that the total energy extracted from the inductor is equal to the total energy stored.

**6.5** The current in a  $200\ \text{mH}$  inductor is

$$i = 75\ \text{mA}, \quad t \leq 0;$$

$$i = (B_1 \cos 200t + B_2 \sin 200t)e^{-50t}\ \text{A}, \quad t \geq 0.$$

The voltage across the inductor (passive sign convention) is  $4.25\ \text{V}$  at  $t = 0$ . Calculate the power at the terminals of the inductor at  $t = 25\ \text{ms}$ . State whether the inductor is absorbing or delivering power.

**6.6** Evaluate the integral

$$\int_0^{\infty} p\ dt$$

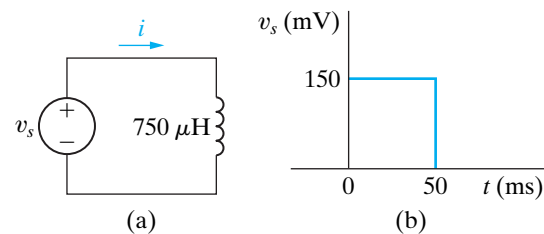
for Example 6.2. Comment on the significance of the result.

**6.7** The voltage at the terminals of the  $750\ \mu\text{H}$  inductor in Fig. P6.7(a) is shown in Fig. P6.7(b). The inductor current  $i$  is known to be zero for  $t \leq 0$ .

PSPICE  
MULTISIM

- Derive the expressions for  $i$  for  $t \geq 0$ .
- Sketch  $i$  versus  $t$  for  $0 \leq t \leq \infty$ .

Figure P6.7



**6.8** The current in the  $50\ \text{mH}$  inductor in Fig. P6.8 is known to be  $100\ \text{mA}$  for  $t < 0$ . The inductor voltage for  $t \geq 0$  is given by the expression

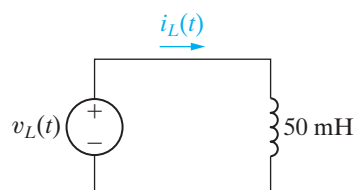
$$v_L(t) = 2e^{-100t}\ \text{V}, \quad 0^+ \leq t \leq 100\ \text{ms}$$

$$v_L(t) = -2e^{-100(t-0.1)}\ \text{V}, \quad 100\ \text{ms} \leq t < \infty$$

Sketch  $v_L(t)$  and  $i_L(t)$  for  $0 \leq t < \infty$ .



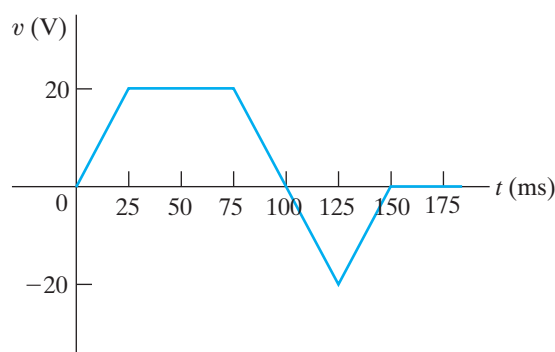
Figure P6.8



6.9 The current in and the voltage across a 10 H inductor are known to be zero for  $t \leq 0$ . The voltage across the inductor is given by the graph in Fig. P6.9 for  $t \geq 0$ .

- Derive the expression for the current as a function of time in the intervals  $0 \leq t \leq 25$  ms,  $25 \text{ ms} \leq t \leq 75$  ms,  $75 \text{ ms} \leq t \leq 125$  ms,  $125 \text{ ms} \leq t \leq 150$  ms, and  $150 \text{ ms} \leq t < \infty$ .
- For  $t > 0$ , what is the current in the inductor when the voltage is zero?
- Sketch  $i$  versus  $t$  for  $0 \leq t < \infty$ .

Figure P6.9

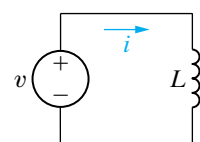


6.10 a) Find the inductor current in the circuit in Fig. P6.10 if  $v = 20 \cos 80t$  V,  $L = 100$  mH, and  $i(0) = 0$  A.

PSPICE  
MULTISIM

- Sketch  $v$ ,  $i$ ,  $p$ , and  $w$  versus  $t$ . In making these sketches, use the format used in Fig. 6.8. Plot over one complete cycle of the voltage waveform.
- Describe the subintervals in the time interval between 0 and  $8\pi$  ms when power is being absorbed by the inductor. Repeat for the subintervals when power is being delivered by the inductor.

Figure P6.10



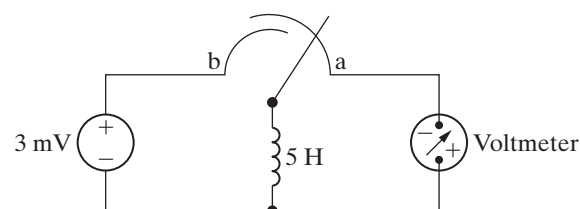
6.11 The current in a 25 mH inductor is known to be  $-10$  A for  $t \leq 0$  and  $(-10 \cos 400t - 5 \sin 400t) e^{-200t}$  A for  $t \geq 0$ . Assume the passive sign convention.

PSPICE  
MULTISIM

- At what instant of time is the voltage across the inductor maximum?
- What is the maximum voltage?

6.12 Initially there was no energy stored in the 5 H inductor in the circuit in Fig. P6.12 when it was placed across the terminals of the voltmeter. At  $t = 0$  the inductor was switched instantaneously to position b where it remained for 1.6 s before returning instantaneously to position a. The d'Arsonval voltmeter has a full-scale reading of 20 V and a sensitivity of  $1000 \Omega/\text{V}$ . What will the reading of the voltmeter be at the instant the switch returns to position a if the inertia of the d'Arsonval movement is negligible?

Figure P6.12



### Section 6.2

6.13 The voltage across a  $5 \mu\text{F}$  capacitor is known to be

$$v_c = 500te^{-2500t} \text{ V for } t \geq 0.$$

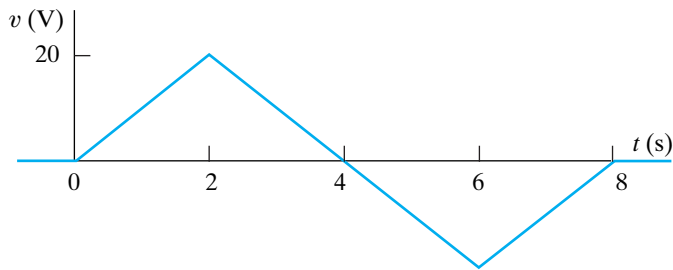
- Find the current through the capacitor for  $t > 0$ . Assume the passive sign convention.
- Find the power at the terminals of the capacitor when  $t = 100 \mu\text{s}$ .
- Is the capacitor absorbing or delivering power at  $t = 100 \mu\text{s}$ ?
- Find the energy stored in the capacitor at  $t = 100 \mu\text{s}$ .
- Find the maximum energy stored in the capacitors and the time when the maximum occurs.

6.14 The triangular voltage pulse shown in Fig. P6.14 is applied to a  $200 \mu\text{F}$  capacitor.

- Write the expressions that describe  $v(t)$  in the five time intervals  $t < 0$ ,  $0 \leq t \leq 2$  s,  $2 \text{ s} \leq t \leq 6$  s,  $6 \text{ s} \leq t \leq 8$  s, and  $t > 8$  s.
- Derive the expressions for the capacitor current, power, and energy for the time intervals in part (a). Use the passive sign convention.

- c) Identify the time intervals between 0 and 8 s when power is being delivered by the capacitor. Repeat for the time intervals when power is being absorbed by the capacitor.

Figure P6.14



- 6.15** The voltage across the terminals of a  $5 \mu\text{F}$  capacitor is

PSPICE  
MULTISIM

$$v = \begin{cases} 60 \text{ V}, & t \leq 0; \\ (A_1 e^{-1500t} + A_2 t e^{-1500t}) \text{ V}, & t \geq 0. \end{cases}$$

The initial current in the capacitor is 100 mA. Assume the passive sign convention.

- a) What is the initial energy stored in the capacitor?  
 b) Evaluate the coefficients  $A_1$  and  $A_2$ .  
 c) What is the expression for the capacitor current?
- 6.16** A  $100 \mu\text{F}$  capacitor is subjected to a voltage pulse having a duration of 4 s. The pulse is described by the following equations:

$$v_c(t) = \begin{cases} 5t^3 \text{ V}, & 0 \leq t \leq 2 \text{ s}; \\ -5(t - 4)^3 \text{ V}, & 2 \text{ s} \leq t \leq 4 \text{ s}; \\ 0 & \text{elsewhere.} \end{cases}$$

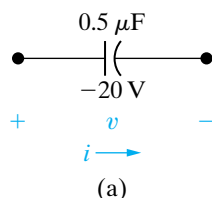
Sketch the current pulse that exists in the capacitor during the 4 s interval.

- 6.17** The voltage at the terminals of the capacitor in Fig. 6.10 is known to be

PSPICE  
MULTISIM

$$v = \begin{cases} 60 \text{ V}, & t \leq 0; \\ 30 + 5e^{-500t} (6 \cos 2000t + \sin 2000t) \text{ V}, & t \geq 0. \end{cases}$$

Figure P6.19



- Assume  $C = 120 \mu\text{F}$ .
- a) Find the current in the capacitor for  $t < 0$ .  
 b) Find the current in the capacitor for  $t > 0$ .  
 c) Is there an instantaneous change in the voltage across the capacitor at  $t = 0$ ?  
 d) Is there an instantaneous change in the current in the capacitor at  $t = 0$ ?  
 e) How much energy (in millijoules) is stored in the capacitor at  $t = \infty$ ?

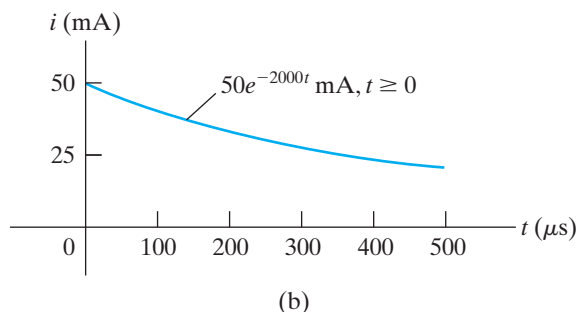
- 6.18** The expressions for voltage, power, and energy derived in Example 6.5 involved both integration and manipulation of algebraic expressions. As an engineer, you cannot accept such results on faith alone. That is, you should develop the habit of asking yourself, “Do these results make sense in terms of the known behavior of the circuit they purport to describe?” With these thoughts in mind, test the expressions of Example 6.5 by performing the following checks:

- a) Check the expressions to see whether the voltage is continuous in passing from one time interval to the next.  
 b) Check the power expression in each interval by selecting a time within the interval and seeing whether it gives the same result as the corresponding product of  $v$  and  $i$ . For example, test at 10 and 30  $\mu\text{s}$ .  
 c) Check the energy expression within each interval by selecting a time within the interval and seeing whether the energy equation gives the same result as  $\frac{1}{2} C v^2$ . Use 10 and 30  $\mu\text{s}$  as test points.

- 6.19** The initial voltage on the  $0.5 \mu\text{F}$  capacitor shown in Fig. P6.19(a) is  $-20 \text{ V}$ . The capacitor current has the waveform shown in Fig. P6.19(b).

PSPICE  
MULTISIM

- a) How much energy, in microjoules, is stored in the capacitor at  $t = 500 \mu\text{s}$ ?  
 b) Repeat (a) for  $t = \infty$ .

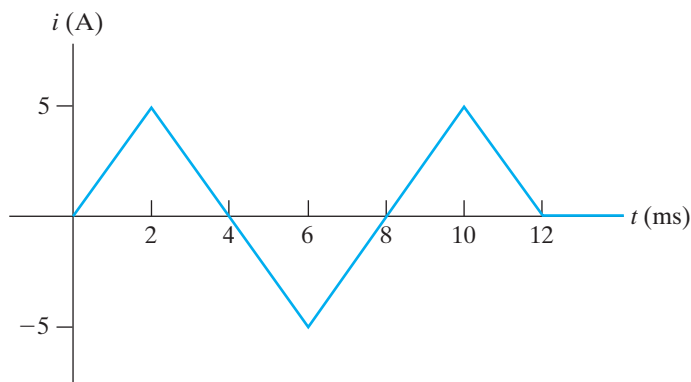


**6.20** The current shown in Fig. 6.20 is applied to a  $2\ \mu\text{F}$  capacitor. The initial voltage on the capacitor is zero.

PSPICE  
MULTISIM

- Find the charge on the capacitor at  $t = 6\ \text{ms}$ .
- Find the voltage on the capacitor at  $t = 10\ \text{ms}$ .
- How much energy is stored in the capacitor by this current?

Figure P6.20

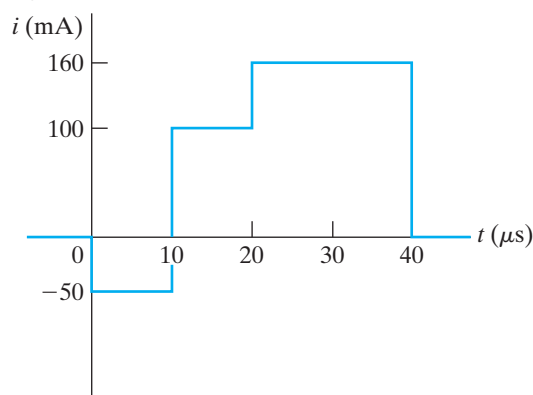


**6.21** The rectangular-shaped current pulse shown in Fig. P6.21 is applied to a  $0.1\ \mu\text{F}$  capacitor. The initial voltage on the capacitor is a  $15\ \text{V}$  drop in the reference direction of the current. Derive the expression for the capacitor voltage for the time intervals in (a)–(d).

PSPICE  
MULTISIM

- $0 \leq t \leq 10\ \mu\text{s}$ ;
- $10\ \mu\text{s} \leq t \leq 20\ \mu\text{s}$ ;
- $20\ \mu\text{s} \leq t \leq 40\ \mu\text{s}$
- $40\ \mu\text{s} \leq t < \infty$
- Sketch  $v(t)$  over the interval  $-10\ \mu\text{s} \leq t \leq 50\ \mu\text{s}$ .

Figure P6.21

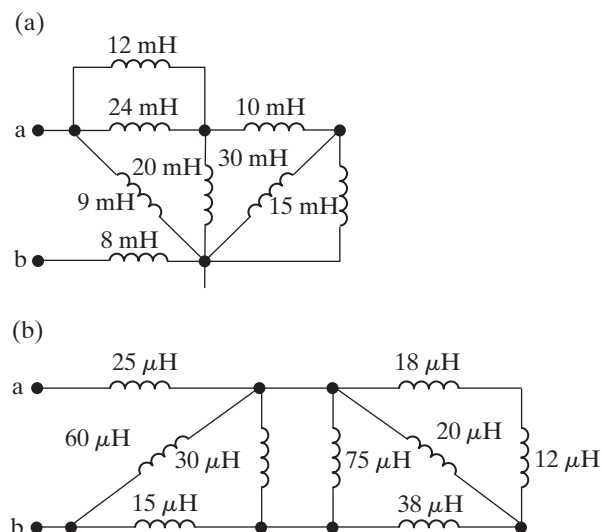


### Section 6.3

**6.22** Assume that the initial energy stored in the inductors of Figs. P6.22(a) and (b) is zero. Find the equivalent inductance with respect to the terminals a, b.

PSPICE  
MULTISIM

Figure P6.22



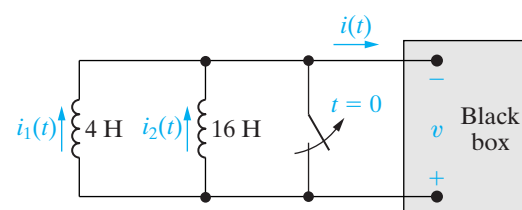
**6.23** Use realistic inductor values from Appendix H to construct series and parallel combinations of inductors to yield the equivalent inductances specified below. Try to minimize the number of inductors used. Assume that no initial energy is stored in any of the inductors.

- $8\ \text{mH}$
- $45\ \mu\text{H}$
- $180\ \mu\text{H}$

**6.24** The two parallel inductors in Fig. P6.24 are connected across the terminals of a black box at  $t = 0$ . The resulting voltage  $v$  for  $t > 0$  is known to be  $64e^{-4t}\ \text{V}$ . It is also known that  $i_1(0) = -10\ \text{A}$  and  $i_2(0) = 5\ \text{A}$ .

- Replace the original inductors with an equivalent inductor and find  $i(t)$  for  $t \geq 0$ .
- Find  $i_1(t)$  for  $t \geq 0$ .
- Find  $i_2(t)$  for  $t \geq 0$ .
- How much energy is delivered to the black box in the time interval  $0 \leq t < \infty$ ?
- How much energy was initially stored in the parallel inductors?
- How much energy is trapped in the ideal inductors?
- Show that your solutions for  $i_1$  and  $i_2$  agree with the answer obtained in (f).

Figure P6.24



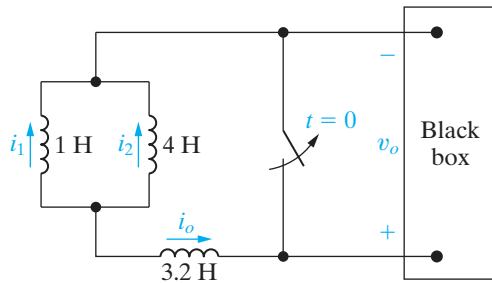
**6.25** The three inductors in the circuit in Fig. P6.25 are connected across the terminals of a black box at  $t = 0$ . The resulting voltage for  $t > 0$  is known to be

$$v_o = 2000e^{-100t} \text{ V.}$$

If  $i_1(0) = -6 \text{ A}$  and  $i_2(0) = 1 \text{ A}$ , find

- $i_o(0)$ ;
- $i_o(t), t \geq 0$ ;
- $i_1(t), t \geq 0$ ;
- $i_2(t), t \geq 0$ ;
- the initial energy stored in the three inductors;
- the total energy delivered to the black box; and
- the energy trapped in the ideal inductors.

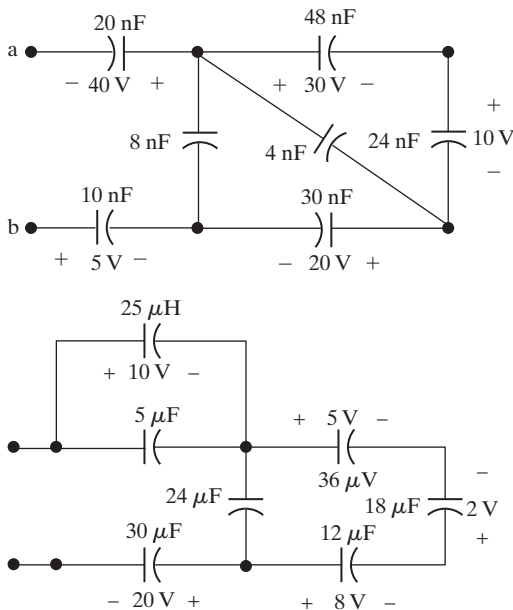
Figure P6.25



**6.26** For the circuit shown in Fig. P6.25, how many milliseconds after the switch is opened is the energy delivered to the black box 80% of the total energy delivered?

**6.27** Find the equivalent capacitance with respect to the terminals a, b for the circuits shown in Fig. P6.27.

Figure P6.27



**6.28** Use realistic capacitor values from Appendix H to construct series and parallel combinations of capacitors to yield the equivalent capacitances specified below. Try to minimize the number of capacitors used. Assume that no initial energy is stored in any of the capacitors.

- 480 pF
- 600 nF
- 120 μF

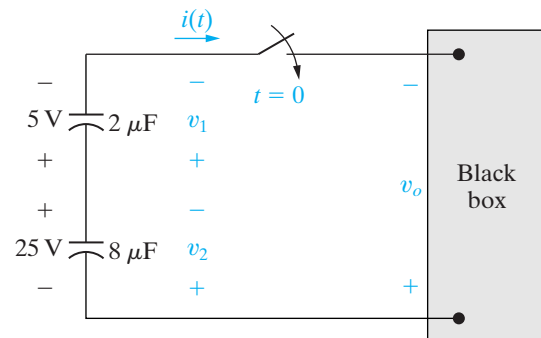
**6.29** Derive the equivalent circuit for a series connection of ideal capacitors. Assume that each capacitor has its own initial voltage. Denote these initial voltages as  $v_1(t_0), v_2(t_0)$ , and so on. (Hint: Sum the voltages across the string of capacitors, recognizing that the series connection forces the current in each capacitor to be the same.)

**6.30** Derive the equivalent circuit for a parallel connection of ideal capacitors. Assume that the initial voltage across the paralleled capacitors is  $v(t_0)$ . (Hint: Sum the currents into the string of capacitors, recognizing that the parallel connection forces the voltage across each capacitor to be the same.)

**6.31** The two series-connected capacitors in Fig. P6.31 are connected to the terminals of a black box at  $t = 0$ . The resulting current  $i(t)$  for  $t > 0$  is known to be  $800e^{-25t} \mu\text{A}$ .

- Replace the original capacitors with an equivalent capacitor and find  $v_o(t)$  for  $t \geq 0$ .
- Find  $v_1(t)$  for  $t \geq 0$ .
- Find  $v_2(t)$  for  $t \geq 0$ .
- How much energy is delivered to the black box in the time interval  $0 \leq t < \infty$ ?
- How much energy was initially stored in the series capacitors?
- How much energy is trapped in the ideal capacitors?
- Show that the solutions for  $v_1$  and  $v_2$  agree with the answer obtained in (f).

Figure P6.31

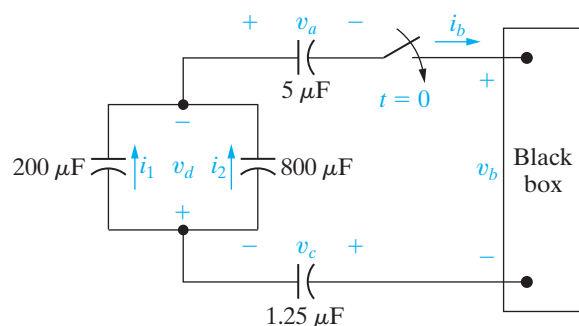


- 6.32** The four capacitors in the circuit in Fig. P6.32 are connected across the terminals of a black box at  $t = 0$ . The resulting current  $i_b$  for  $t > 0$  is known to be

$$i_b = -5e^{-50t} \text{ mA.}$$

If  $v_a(0) = -20 \text{ V}$ ,  $v_c(0) = -30 \text{ V}$ , and  $v_d(0) = 250 \text{ V}$ , find the following for  $t \geq 0$ : (a)  $v_b(t)$ , (b)  $v_a(t)$ , (c)  $v_c(t)$ , (d)  $v_d(t)$ , (e)  $i_1(t)$ , and (f)  $i_2(t)$ .

Figure P6.32



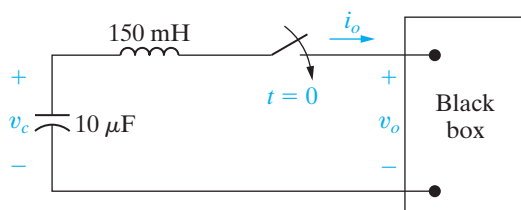
- 6.33** For the circuit in Fig. P6.32, calculate
- the initial energy stored in the capacitors;
  - the final energy stored in the capacitors;
  - the total energy delivered to the black box;
  - the percentage of the initial energy stored that is delivered to the black box; and
  - the time, in milliseconds, it takes to deliver 7.5 mJ to the black box.

- 6.34** At  $t = 0$ , a series-connected capacitor and inductor are placed across the terminals of a black box, as shown in Fig. P6.34. For  $t > 0$ , it is known that

$$i_o = 200e^{-800t} - 40e^{-200t} \text{ mA.}$$

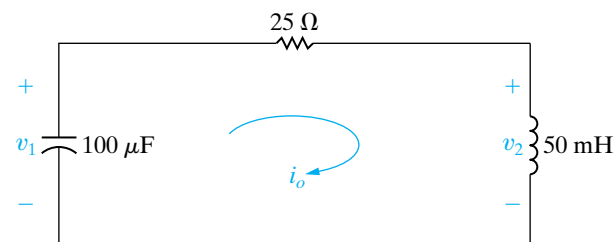
If  $v_c(0) = 5 \text{ V}$  find  $v_o$  for  $t \geq 0$ .

Figure P6.34



- 6.35** The current in the circuit in Fig. P6.35 is known to be
- $$i_o = 2e^{-5000t}(\cos 1000t + 5 \sin 1000t) \text{ A}$$
- for  $t \geq 0^+$ . Find  $v_1(0^+)$  and  $v_2(0^+)$ .

Figure P6.35



## Section 6.4

- 6.36** a) Show that the differential equations derived in (a) of Example 6.6 can be rearranged as follows:

$$4 \frac{di_1}{dt} + 25i_1 - 8 \frac{di_2}{dt} - 20i_2 = 5i_g - 8 \frac{di_g}{dt};$$

$$-8 \frac{di_1}{dt} - 20i_1 + 16 \frac{di_2}{dt} + 80i_2 = 16 \frac{di_g}{dt}.$$

- b) Show that the solutions for  $i_1$ , and  $i_2$  given in (b) of Example 6.6 satisfy the differential equations given in part (a) of this problem.

- 6.37** Let  $v_o$  represent the voltage across the 16 H inductor in the circuit in Fig. 6.25. Assume  $v_o$  is positive at the dot. As in Example 6.6,  $i_g = 16 - 16e^{-5t} \text{ A}$ .

- Can you find  $v_o$  without having to differentiate the expressions for the currents? Explain.
- Derive the expression for  $v_o$ .
- Check your answer in (b) using the appropriate current derivatives and inductances.

- 6.38** Let  $v_g$  represent the voltage across the current source in the circuit in Fig. 6.25. The reference for  $v_g$  is positive at the upper terminal of the current source.

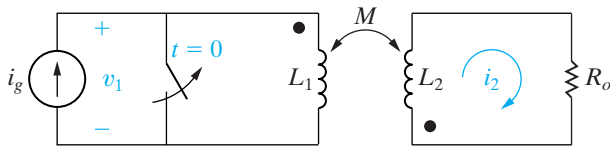
- Find  $v_g$  as a function of time when  $i_g = 16 - 16e^{-5t} \text{ A}$ .
- What is the initial value of  $v_g$ ?
- Find the expression for the power developed by the current source.
- How much power is the current source developing when  $t$  is infinite?
- Calculate the power dissipated in each resistor when  $t$  is infinite.

- 6.39** There is no energy stored in the circuit in Fig. P6.39 at the time the switch is opened.

- Derive the differential equation that governs the behavior of  $i_2$  if  $L_1 = 5 \text{ H}$ ,  $L_2 = 0.2 \text{ H}$ ,  $M = 0.5 \text{ H}$ , and  $R_o = 10 \Omega$ .

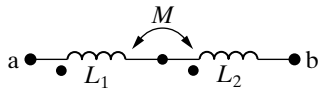
- b) Show that when  $i_g = e^{-10t} - 10$  A,  $t \geq 0$ , the differential equation derived in (a) is satisfied when  $i_2 = 625e^{-10t} - 250e^{-50t}$  mA,  $t \geq 0$ .
- c) Find the expression for the voltage  $v_1$  across the current source.
- d) What is the initial value of  $v_1$ ? Does this make sense in terms of known circuit behavior?

Figure P6.39



- 6.40** a) Show that the two coupled coils in Fig. P6.40 can be replaced by a single coil having an inductance of  $L_{ab} = L_1 + L_2 + 2M$ . (Hint: Express  $v_{ab}$  as a function of  $i_{ab}$ .)
- b) Show that if the connections to the terminals of the coil labeled  $L_2$  are reversed,  $L_{ab} = L_1 + L_2 - 2M$ .

Figure P6.40



- 6.41** a) Show that the two magnetically coupled coils in Fig. P6.41 (see page 210) can be replaced by a single coil having an inductance of

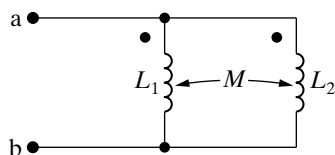
$$L_{ab} = \frac{L_1 L_2 - M^2}{L_1 + L_2 - 2M}$$

(Hint: Let  $i_1$  and  $i_2$  be clockwise mesh currents in the left and right “windows” of Fig. P6.41, respectively. Sum the voltages around the two meshes. In mesh 1 let  $v_{ab}$  be the unspecified applied voltage. Solve for  $di_1/dt$  as a function of  $v_{ab}$ .)

- b) Show that if the magnetic polarity of coil 2 is reversed, then

$$L_{ab} = \frac{L_1 L_2 - M^2}{L_1 + L_2 + 2M}$$

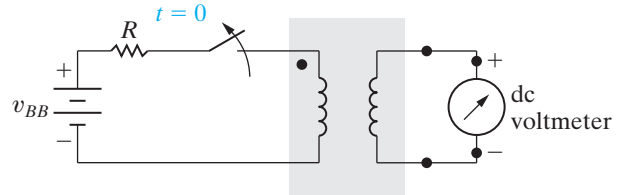
Figure P6.41



- 6.42** The polarity markings on two coils are to be determined experimentally. The experimental setup is shown in Fig. P6.42. Assume that the terminal connected to the positive terminal of the battery has

been given a polarity mark as shown. When the switch is opened, the dc voltmeter kicks down-scale. Where should the polarity mark be placed on the coil connected to the voltmeter?

Figure P6.42



- 6.43** The physical construction of four pairs of magnetically coupled coils is shown in Fig. P6.43. (See page 211.) Assume that the magnetic flux is confined to the core material in each structure. Show two possible locations for the dot markings on each pair of coils.

**Section 6.5**

- 6.44** a) Starting with Eq. 6.59, show that the coefficient of coupling can also be expressed as

$$k = \sqrt{\left(\frac{\phi_{21}}{\phi_1}\right)\left(\frac{\phi_{12}}{\phi_2}\right)}$$

- b) On the basis of the fractions  $\phi_{21}/\phi_1$  and  $\phi_{12}/\phi_2$ , explain why  $k$  is less than 1.0.
- 6.45** Two magnetically coupled coils have self-inductances of 60 mH and 9.6 mH, respectively. The mutual inductance between the coils is 22.8 mH.
- a) What is the coefficient of coupling?
  - b) For these two coils, what is the largest value that  $M$  can have?
  - c) Assume that the physical structure of these coupled coils is such that  $\mathcal{P}_1 = \mathcal{P}_2$ . What is the turns ratio  $N_1/N_2$  if  $N_1$  is the number of turns on the 60 mH coil?
- 6.46** Two magnetically coupled coils are wound on a nonmagnetic core. The self-inductance of coil 1 is 288 mH, the mutual inductance is 90 mH, the coefficient of coupling is 0.75, and the physical structure of the coils is such that  $\mathcal{P}_{11} = \mathcal{P}_{22}$ .
- a) Find  $L_2$  and the turns ratio  $N_1/N_2$ .
  - b) If  $N_1 = 1200$ , what is the value of  $\mathcal{P}_1$  and  $\mathcal{P}_2$ ?
- 6.47** The self-inductances of the coils in Fig. 6.30 are  $L_1 = 18$  mH and  $L_2 = 32$  mH. If the coefficient of coupling is 0.85, calculate the energy stored in the system in millijoules when (a)  $i_1 = 6$  A,  $i_2 = 9$  A; (b)  $i_1 = -6$  A,  $i_2 = -9$  A; (c)  $i_1 = -6$  A,  $i_2 = 9$  A; and (d)  $i_1 = 6$  A,  $i_2 = -9$  A.



- 6.48** The coefficient of coupling in Problem 6.47 is increased to 1.0.
- If  $i_1$  equals 6 A, what value of  $i_2$  results in zero stored energy?
  - Is there any physically realizable value of  $i_2$  that can make the stored energy negative?
- 6.49** The self-inductances of two magnetically coupled coils are 72 mH and 40.5 mH, respectively. The 72 mH coil has 250 turns, and the coefficient of coupling between the coils is  $\frac{2}{3}$ . The coupling medium is nonmagnetic. When coil 1 is excited with coil 2 open, the flux linking only coil 1 is 0.2 as large as the flux linking coil 2.
- How many turns does coil 2 have?
  - What is the value of  $\mathcal{P}_2$  in nanowebers per ampere?
  - What is the value of  $\mathcal{P}_{11}$  in nanowebers per ampere?
  - What is the ratio  $(\phi_{22}/\phi_{12})$ ?
- 6.50** The self-inductances of two magnetically coupled coils are  $L_1 = 180 \mu\text{H}$  and  $L_2 = 500 \mu\text{H}$ . The coupling medium is nonmagnetic. If coil 1 has 300 turns and coil 2 has 500 turns, find  $\mathcal{P}_{11}$  and  $\mathcal{P}_{21}$  (in nanowebers per ampere) when the coefficient of coupling is 0.6.

### Sections 6.1–6.5

- 6.51** Suppose a capacitive touch screen that uses the mutual-capacitance design, as shown in Fig. 6.33, is touched at the point  $x, y$ . Determine the mutual capacitance at that point,  $C'_{mxy}$ , in terms of the mutual capacitance at the point without a touch,  $C_{mxy}$ , and the capacitance introduced by the touch,  $C_t$ .
- 6.52** a) Assume the parasitic capacitance in the self-capacitance design,  $C_p = 30 \text{ pF}$ , and the capacitance introduced by a touch is 15 pF (see Fig. 6.32[b]). What is the capacitance at the touch point with respect to ground for the  $x$ -grid and  $y$ -grid electrodes closest to the touch point?
- b) Assume the mutual capacitance in the mutual-capacitance design,  $C_{mxy} = 30 \text{ pF}$ , and the capacitance introduced by a touch is 15 pF (see Fig. 6.33[b]). What is the mutual capacitance between the  $x$ - and  $y$ -grid electrodes closest to the touch point?
- c) Compare your results in parts (a) and (b) – does touching the screen increase or decrease the capacitance in these two different capacitive touch screen designs?
- 6.53** a) As shown in the Practical Perspective, the self-capacitance design does not permit a true multi-touch screen – if the screen is touched at two difference points, a total of four touch points are identified, the two actual touch points and two ghost points. If a self-capacitance touch screen is touched at the  $x, y$  coordinates (2.1, 4.3) and (3.2, 2.5), what are the four touch locations that will be identified? (Assume the touch coordinates are measured in inches from the upper left corner of the screen.)
- b) A self-capacitance touch screen can still function as a multi-touch screen for several common gestures. For example, suppose at time  $t_1$  the two touch points are those identified in part (a), and at time  $t_2$  four touch points associated with the  $x, y$  coordinates (1.8, 4.9) and (3.9, 1.8) are identified. Comparing the four points at  $t_1$  with the four points at  $t_2$ , software can recognize a pinch gesture – should the screen be zoomed in or zoomed out?
- c) Repeat part (b), assuming that at time  $t_2$  four touch points associated with the  $x, y$  coordinates (2.8, 3.9) and (3.0, 2.8) are identified.



# Response of First-Order *RL* and *RC* Circuits

## CHAPTER CONTENTS

- 7.1 The Natural Response of an *RL* Circuit p. 214
- 7.2 The Natural Response of an *RC* Circuit p. 220
- 7.3 The Step Response of *RL* and *RC* Circuits p. 224
- 7.4 A General Solution for Step and Natural Responses p. 231
- 7.5 Sequential Switching p. 236
- 7.6 Unbounded Response p. 240
- 7.7 The Integrating Amplifier p. 241

## ✓ CHAPTER OBJECTIVES

- 1 Be able to determine the natural response of both *RL* and *RC* circuits.
- 2 Be able to determine the step response of both *RL* and *RC* circuits.
- 3 Know how to analyze circuits with sequential switching.
- 4 Be able to analyze op amp circuits containing resistors and a single capacitor.

In Chapter 6, we noted that an important attribute of inductors and capacitors is their ability to store energy. We are now in a position to determine the currents and voltages that arise when energy is either released or acquired by an inductor or capacitor in response to an abrupt change in a dc voltage or current source. In this chapter, we will focus on circuits that consist only of sources, resistors, and either (but not both) inductors or capacitors. For brevity, such configurations are called ***RL*** (resistor-inductor) and ***RC*** (resistor-capacitor) **circuits**.

Our analysis of *RL* and *RC* circuits will be divided into three phases. In the first phase, we consider the currents and voltages that arise when stored energy in an inductor or capacitor is suddenly released to a resistive network. This happens when the inductor or capacitor is abruptly disconnected from its dc source. Thus we can reduce the circuit to one of the two equivalent forms shown in Fig. 7.1 on page 214. The currents and voltages that arise in this configuration are referred to as the **natural response** of the circuit, to emphasize that the nature of the circuit itself, not external sources of excitation, determines its behavior.

In the second phase of our analysis, we consider the currents and voltages that arise when energy is being acquired by an inductor or capacitor due to the sudden application of a dc voltage or current source. This response is referred to as the **step response**. The process for finding both the natural and step responses is the same; thus, in the third phase of our analysis, we develop a general method that can be used to find the response of *RL* and *RC* circuits to any abrupt change in a dc voltage or current source.

Figure 7.2 on page 214 shows the four possibilities for the general configuration of *RL* and *RC* circuits. Note that when there are no independent sources in the circuit, the Thévenin voltage or Norton current is zero, and the circuit reduces to one of those shown in Fig. 7.1; that is, we have a natural-response problem.

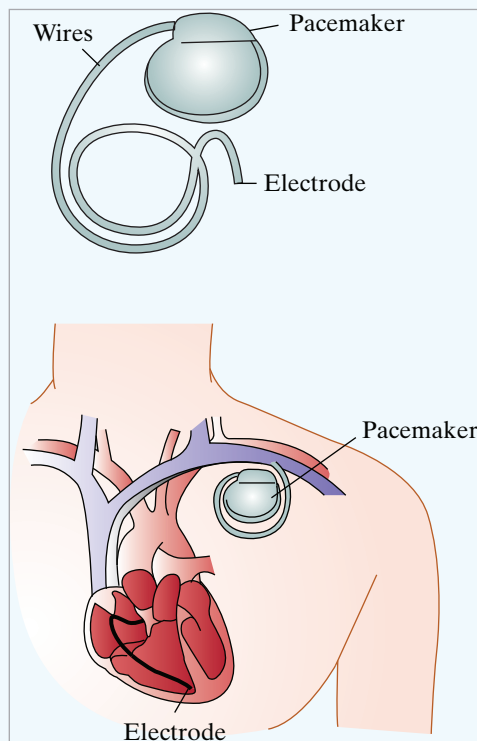
## Practical Perspective

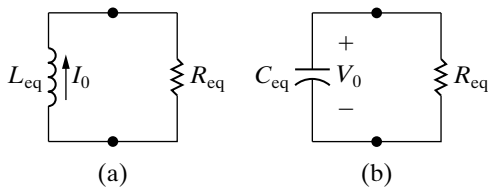
### Artificial Pacemaker

The muscle that makes up the heart contracts due to rhythmical electrical impulses. The frequency of the impulses is controlled by pacemaker cells. In adults, the pacemaker cells establish a resting heart rate of about 72 beats per minutes. But sometimes the pacemaker cells are damaged and may produce a very low resting heart rate (a condition known as bradycardia) or a very high resting heart rate (a condition known as tachycardia). A normal heart rhythm can be restored by implanting an artificial pacemaker that delivers electrical impulses to the heart, mimicking the pacemaker cells. An example of an artificial

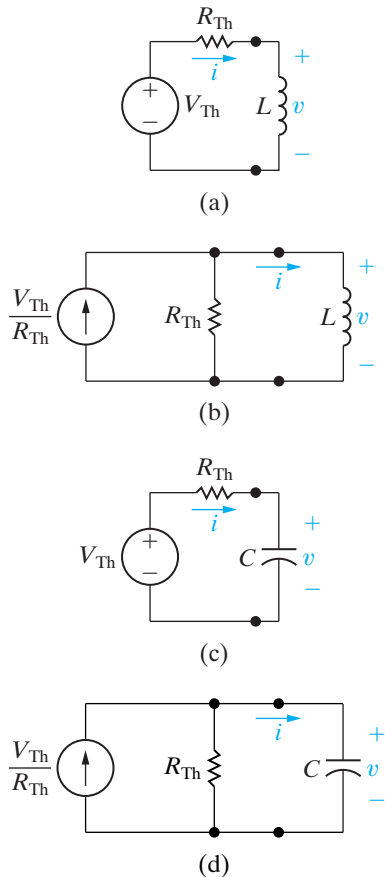
pacemaker both outside and inside the body is shown in the figures below.

Artificial pacemakers are very small and lightweight. They have a programmable microprocessor that monitors a few parameters and adjusts the heart rate, an efficient battery with a life of up to 15 years, and circuitry that generates the pulse. The simplest circuit consists of a resistor and a capacitor. Once we have introduced the first-order RC circuit, we will look at an RC circuit design for artificial pacemakers.

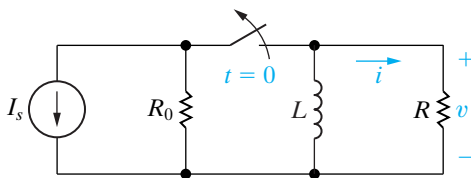




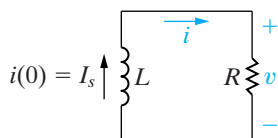
**Figure 7.1** ▲ The two forms of the circuits for natural response. (a)  $RL$  circuit. (b)  $RC$  circuit.



**Figure 7.2** ▲ Four possible first-order circuits. (a) An inductor connected to a Thévenin equivalent. (b) An inductor connected to a Norton equivalent. (c) A capacitor connected to a Thévenin equivalent. (d) A capacitor connected to a Norton equivalent.



**Figure 7.3** ▲ An  $RL$  circuit.



**Figure 7.4** ▲ The circuit shown in Fig. 7.3, for  $t \geq 0$ .

$RL$  and  $RC$  circuits are also known as **first-order circuits**, because their voltages and currents are described by first-order differential equations. No matter how complex a circuit may appear, if it can be reduced to a Thévenin or Norton equivalent connected to the terminals of an equivalent inductor or capacitor, it is a first-order circuit. (Note that if multiple inductors or capacitors exist in the original circuit, they must be interconnected so that they can be replaced by a single equivalent element.)

After introducing the techniques for analyzing the natural and step responses of first-order circuits, we discuss some special cases of interest. The first is that of sequential switching, involving circuits in which switching can take place at two or more instants in time. Next is the unbounded response. Finally, we analyze a useful circuit called the integrating amplifier.

## 7.1 The Natural Response of an $RL$ Circuit

The natural response of an  $RL$  circuit can best be described in terms of the circuit shown in Fig. 7.3. We assume that the independent current source generates a constant current of  $I_s$  A, and that the switch has been in a closed position for a long time. We define the phrase *a long time* more accurately later in this section. For now it means that all currents and voltages have reached a constant value. Thus only constant, or dc, currents can exist in the circuit just prior to the switch's being opened, and therefore the inductor appears as a short circuit ( $Ldi/dt = 0$ ) prior to the release of the stored energy.

Because the inductor appears as a short circuit, the voltage across the inductive branch is zero, and there can be no current in either  $R_0$  or  $R$ . Therefore, all the source current  $I_s$  appears in the inductive branch. Finding the natural response requires finding the voltage and current at the terminals of the resistor after the switch has been opened, that is, after the source has been disconnected and the inductor begins releasing energy. If we let  $t = 0$  denote the instant when the switch is opened, the problem becomes one of finding  $v(t)$  and  $i(t)$  for  $t \geq 0$ . For  $t \geq 0$ , the circuit shown in Fig. 7.3 reduces to the one shown in Fig. 7.4.

### Deriving the Expression for the Current

To find  $i(t)$ , we use Kirchhoff's voltage law to obtain an expression involving  $i$ ,  $R$ , and  $L$ . Summing the voltages around the closed loop gives

$$L \frac{di}{dt} + Ri = 0, \quad (7.1)$$

where we use the passive sign convention. Equation 7.1 is known as a first-order ordinary differential equation, because it contains terms involving the ordinary derivative of the unknown, that is,  $di/dt$ . The highest order derivative appearing in the equation is 1; hence the term **first-order**.

We can go one step further in describing this equation. The coefficients in the equation,  $R$  and  $L$ , are constants; that is, they are not functions of either the dependent variable  $i$  or the independent variable  $t$ . Thus the equation can also be described as an ordinary differential equation with constant coefficients.

To solve Eq. 7.1, we divide by  $L$ , transpose the term involving  $i$  to the right-hand side, and then multiply both sides by a differential time  $dt$ . The result is

$$\frac{di}{dt} dt = -\frac{R}{L} i dt. \quad (7.2)$$

Next, we recognize the left-hand side of Eq. 7.2 as a differential change in the current  $i$ , that is,  $di$ . We now divide through by  $i$ , getting

$$\frac{di}{i} = -\frac{R}{L}dt. \quad (7.3)$$

We obtain an explicit expression for  $i$  as a function of  $t$  by integrating both sides of Eq. 7.3. Using  $x$  and  $y$  as variables of integration yields

$$\int_{i(t_0)}^{i(t)} \frac{dx}{x} = -\frac{R}{L} \int_{t_0}^t dy, \quad (7.4)$$

in which  $i(t_0)$  is the current corresponding to time  $t_0$ , and  $i(t)$  is the current corresponding to time  $t$ . Here,  $t_0 = 0$ . Therefore, carrying out the indicated integration gives

$$\ln \frac{i(t)}{i(0)} = -\frac{R}{L}t. \quad (7.5)$$

Based on the definition of the natural logarithm,

$$i(t) = i(0)e^{-(R/L)t}. \quad (7.6)$$

Recall from Chapter 6 that an instantaneous change of current cannot occur in an inductor. Therefore, in the first instant after the switch has been opened, the current in the inductor remains unchanged. If we use  $0^-$  to denote the time just prior to switching, and  $0^+$  for the time immediately following switching, then

$$i(0^-) = i(0^+) = I_0,$$

where, as in Fig. 7.1,  $I_0$  denotes the initial current in the inductor. The initial current in the inductor is oriented in the same direction as the reference direction of  $i$ . Hence Eq. 7.6 becomes

$$i(t) = I_0e^{-(R/L)t}, \quad t \geq 0, \quad (7.7)$$

which shows that the current starts from an initial value  $I_0$  and decreases exponentially toward zero as  $t$  increases. Figure 7.5 shows this response.

We derive the voltage across the resistor in Fig. 7.4 from a direct application of Ohm's law:

$$v = iR = I_0Re^{-(R/L)t}, \quad t \geq 0^+. \quad (7.8)$$

Note that in contrast to the expression for the current shown in Eq. 7.7, the voltage is defined only for  $t > 0$ , not at  $t = 0$ . The reason is that a step change occurs in the voltage at zero. Note that for  $t < 0$ , the derivative of the current is zero, so the voltage is also zero. (This result follows from  $v = Ldi/dt = 0$ .) Thus

$$v(0^-) = 0, \quad (7.9)$$

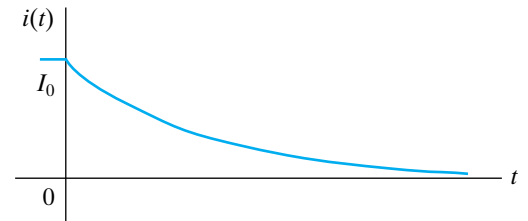
$$v(0^+) = I_0R, \quad (7.10)$$

where  $v(0^+)$  is obtained from Eq. 7.8 with  $t = 0^+$ .<sup>1</sup> With this step change at an instant in time, the value of the voltage at  $t = 0$  is unknown. Thus we use  $t \geq 0^+$  in defining the region of validity for these solutions.

<sup>1</sup> We can define the expressions  $0^-$  and  $0^+$  more formally. The expression  $x(0^-)$  refers to the limit of the variable  $x$  as  $t \rightarrow 0$  from the left, or from negative time. The expression  $x(0^+)$  refers to the limit of the variable  $x$  as  $t \rightarrow 0$  from the right, or from positive time.

#### ◀ Initial inductor current

#### ◀ Natural response of an *RL* circuit



**Figure 7.5** ▲ The current response for the circuit shown in Fig. 7.4.

We derive the power dissipated in the resistor from any of the following expressions:

$$p = vi, \quad p = i^2R, \quad \text{or} \quad p = \frac{v^2}{R}. \quad (7.11)$$

Whichever form is used, the resulting expression can be reduced to

$$p = I_0^2 R e^{-2(R/L)t}, \quad t \geq 0^+. \quad (7.12)$$

The energy delivered to the resistor during any interval of time after the switch has been opened is

$$\begin{aligned} w &= \int_0^t p dx = \int_0^t I_0^2 R e^{-2(R/L)x} dx \\ &= \frac{1}{2(R/L)} I_0^2 R (1 - e^{-2(R/L)t}) \\ &= \frac{1}{2} L I_0^2 (1 - e^{-2(R/L)t}), \quad t \geq 0. \end{aligned} \quad (7.13)$$

Note from Eq. 7.13 that as  $t$  becomes infinite, the energy dissipated in the resistor approaches the initial energy stored in the inductor.

### The Significance of the Time Constant

The expressions for  $i(t)$  (Eq. 7.7) and  $v(t)$  (Eq. 7.8) include a term of the form  $e^{-(R/L)t}$ . The coefficient of  $t$ —namely,  $R/L$ —determines the rate at which the current or voltage approaches zero. The reciprocal of this ratio is the **time constant** of the circuit, denoted

Time constant for  $RL$  circuit ►

$$\tau = \text{time constant} = \frac{L}{R}. \quad (7.14)$$

Using the time-constant concept, we write the expressions for current, voltage, power, and energy as

$$i(t) = I_0 e^{-t/\tau}, \quad t \geq 0, \quad (7.15)$$

$$v(t) = I_0 R e^{-t/\tau}, \quad t \geq 0^+, \quad (7.16)$$

$$p = I_0^2 R e^{-2t/\tau}, \quad t \geq 0^+, \quad (7.17)$$

$$w = \frac{1}{2} L I_0^2 (1 - e^{-2t/\tau}), \quad t \geq 0. \quad (7.18)$$

The time constant is an important parameter for first-order circuits, so mentioning several of its characteristics is worthwhile. First, it is convenient to think of the time elapsed after switching in terms of integral multiples of  $\tau$ . Thus one time constant after the inductor has begun to release its stored energy to the resistor, the current has been reduced to  $e^{-1}$ , or approximately 0.37 of its initial value.

Table 7.1 gives the value of  $e^{-t/\tau}$  for integral multiples of  $\tau$  from 1 to 10. Note that when the elapsed time exceeds five time constants, the current is less than 1% of its initial value. Thus we sometimes say that five time constants after switching has occurred, the currents and voltages have, for most practical purposes, reached their final values. For single time-constant circuits (first-order circuits) with 1% accuracy, the phrase *a long time* implies that five or more time constants have elapsed. Thus the existence of current in the RL circuit shown in Fig. 7.1(a) is a momentary event and is referred to as the **transient response** of the circuit. The response that exists a long time after the switching has taken place is called the **steady-state response**. The phrase *a long time* then also means the time it takes the circuit to reach its steady-state value.

Any first-order circuit is characterized, in part, by the value of its time constant. If we have no method for calculating the time constant of such a circuit (perhaps because we don't know the values of its components), we can determine its value from a plot of the circuit's natural response. That's because another important characteristic of the time constant is that it gives the time required for the current to reach its final value if the current continues to change at its initial rate. To illustrate, we evaluate  $di/dt$  at  $0^+$  and assume that the current continues to change at this rate:

$$\frac{di}{dt}(0^+) = -\frac{R}{L}I_0 = -\frac{I_0}{\tau}. \quad (7.19)$$

Now, if  $i$  starts as  $I_0$  and decreases at a constant rate of  $I_0/\tau$  amperes per second, the expression for  $i$  becomes

$$i = I_0 - \frac{I_0}{\tau}t. \quad (7.20)$$

Equation 7.20 indicates that  $i$  would reach its final value of zero in  $\tau$  seconds. Figure 7.6 shows how this graphic interpretation is useful in estimating the time constant of a circuit from a plot of its natural response. Such a plot could be generated on an oscilloscope measuring output current. Drawing the tangent to the natural response plot at  $t = 0$  and reading the value at which the tangent intersects the time axis gives the value of  $\tau$ .

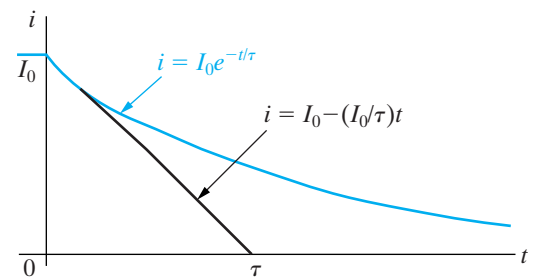
Calculating the natural response of an RL circuit can be summarized as follows:

1. Find the initial current,  $I_0$ , through the inductor.
2. Find the time constant of the circuit,  $\tau = L/R$ .
3. Use Eq. 7.15,  $I_0e^{-t/\tau}$ , to generate  $i(t)$  from  $I_0$  and  $\tau$ .

All other calculations of interest follow from knowing  $i(t)$ . Examples 7.1 and 7.2 illustrate the numerical calculations associated with the natural response of an RL circuit.

**TABLE 7.1** Value of  $e^{-t/\tau}$  For  $t$  Equal to Integral Multiples of  $\tau$

$t$	$e^{-t/\tau}$	$t$	$e^{-t/\tau}$
$\tau$	$3.6788 \times 10^{-1}$	$6\tau$	$2.4788 \times 10^{-3}$
$2\tau$	$1.3534 \times 10^{-1}$	$7\tau$	$9.1188 \times 10^{-4}$
$3\tau$	$4.9787 \times 10^{-2}$	$8\tau$	$3.3546 \times 10^{-4}$
$4\tau$	$1.8316 \times 10^{-2}$	$9\tau$	$1.2341 \times 10^{-4}$
$5\tau$	$6.7379 \times 10^{-3}$	$10\tau$	$4.5400 \times 10^{-5}$



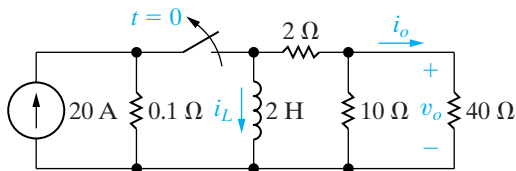
**Figure 7.6** ▲ A graphic interpretation of the time constant of the RL circuit shown in Fig. 7.4.

#### ◀ Calculating the natural response of RL circuit

**Example 7.1** Determining the Natural Response of an  $RL$  Circuit

The switch in the circuit shown in Fig. 7.7 has been closed for a long time before it is opened at  $t = 0$ . Find

- $i_L(t)$  for  $t \geq 0$ ,
- $i_o(t)$  for  $t \geq 0^+$ ,
- $v_o(t)$  for  $t \geq 0^+$ ,
- the percentage of the total energy stored in the 2 H inductor that is dissipated in the 10  $\Omega$  resistor.



**Figure 7.7** ▲ The circuit for Example 7.1.

**Solution**

- a) The switch has been closed for a long time prior to  $t = 0$ , so we know the voltage across the inductor must be zero at  $t = 0^-$ . Therefore the initial current in the inductor is 20 A at  $t = 0^-$ . Hence,  $i_L(0^+)$  also is 20 A, because an instantaneous change in the current cannot occur in an inductor. We replace the resistive circuit connected to the terminals of the inductor with a single resistor of 10  $\Omega$ :

$$R_{\text{eq}} = 2 + (40 \parallel 10) = 10 \Omega.$$

The time constant of the circuit is  $L/R_{\text{eq}}$ , or 0.2 s, giving the expression for the inductor current as

$$i_L(t) = 20e^{-5t} \text{ A}, \quad t \geq 0.$$

- b) We find the current in the 40  $\Omega$  resistor most easily by using current division; that is,

$$i_o = -i_L \frac{10}{10 + 40}.$$

Note that this expression is valid for  $t \geq 0^+$  because  $i_o = 0$  at  $t = 0^-$ . The inductor behaves as a short circuit prior to the switch being opened, producing an instantaneous change in the current  $i_o$ . Then,

$$i_o(t) = -4e^{-5t} \text{ A}, \quad t \geq 0^+.$$

- c) We find the voltage  $v_o$  by direct application of Ohm's law:

$$v_o(t) = 40i_o = -160e^{-5t} \text{ V}, \quad t \geq 0^+.$$

- d) The power dissipated in the 10  $\Omega$  resistor is

$$p_{10\Omega}(t) = \frac{v_o^2}{10} = 2560e^{-10t} \text{ W}, \quad t \geq 0^+.$$

The total energy dissipated in the 10  $\Omega$  resistor is

$$w_{10\Omega}(t) = \int_0^\infty 2560e^{-10t} dt = 256 \text{ J}.$$

The initial energy stored in the 2 H inductor is

$$w(0) = \frac{1}{2} Li^2(0) = \frac{1}{2} (2)(400) = 400 \text{ J}.$$

Therefore the percentage of energy dissipated in the 10  $\Omega$  resistor is

$$\frac{256}{400}(100) = 64\%.$$



**Example 7.2** Determining the Natural Response of an RL Circuit with Parallel Inductors

In the circuit shown in Fig. 7.8, the initial currents in inductors  $L_1$  and  $L_2$  have been established by sources not shown. The switch is opened at  $t = 0$ .

- Find  $i_1$ ,  $i_2$ , and  $i_3$  for  $t \geq 0$ .
- Calculate the initial energy stored in the parallel inductors.
- Determine how much energy is stored in the inductors as  $t \rightarrow \infty$ .
- Show that the total energy delivered to the resistive network equals the difference between the results obtained in (b) and (c).

**Solution**

- The key to finding currents  $i_1$ ,  $i_2$ , and  $i_3$  lies in knowing the voltage  $v(t)$ . We can easily find  $v(t)$  if we reduce the circuit shown in Fig. 7.8 to the equivalent form shown in Fig. 7.9. The parallel inductors simplify to an equivalent inductance of 4 H, carrying an initial current of 12 A. The resistive network reduces to a single resistance of 8  $\Omega$ . Hence the initial value of  $i(t)$  is 12 A and the time constant is 4/8, or 0.5 s. Therefore

$$i(t) = 12e^{-2t} \text{ A}, \quad t \geq 0.$$

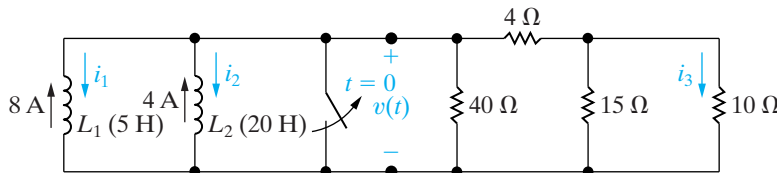
Now  $v(t)$  is simply the product  $8i$ , so

$$v(t) = 96e^{-2t} \text{ V}, \quad t \geq 0^+.$$

The circuit shows that  $v(t) = 0$  at  $t = 0^-$ , so the expression for  $v(t)$  is valid for  $t \geq 0^+$ . After obtaining  $v(t)$ , we can calculate  $i_1$ ,  $i_2$ , and  $i_3$ :

$$\begin{aligned} i_1 &= \frac{1}{5} \int_0^t 96e^{-2x} dx - 8 \\ &= 1.6 - 9.6e^{-2t} \text{ A}, \quad t \geq 0, \end{aligned}$$

$$i_2 = \frac{1}{20} \int_0^t 96e^{-2x} dx - 4$$

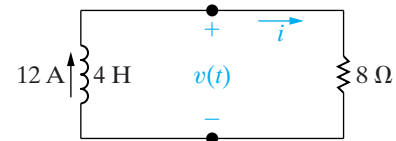


**Figure 7.8** ▲ The circuit for Example 7.2.

$$= -1.6 - 2.4e^{-2t} \text{ A}, \quad t \geq 0,$$

$$i_3 = \frac{v(t)}{10} \frac{15}{25} = 5.76e^{-2t} \text{ A}, \quad t \geq 0^+.$$

Note that the expressions for the inductor currents  $i_1$  and  $i_2$  are valid for  $t \geq 0$ , whereas the expression for the resistor current  $i_3$  is valid for  $t \geq 0^+$ .



**Figure 7.9** ▲ A simplification of the circuit shown in Fig. 7.8.

- The initial energy stored in the inductors is

$$w = \frac{1}{2}(5)(64) + \frac{1}{2}(20)(16) = 320 \text{ J}.$$

- As  $t \rightarrow \infty$ ,  $i_1 \rightarrow 1.6 \text{ A}$  and  $i_2 \rightarrow -1.6 \text{ A}$ . Therefore, a long time after the switch has been opened, the energy stored in the two inductors is

$$w = \frac{1}{2}(5)(1.6)^2 + \frac{1}{2}(20)(-1.6)^2 = 32 \text{ J}.$$

- We obtain the total energy delivered to the resistive network by integrating the expression for the instantaneous power from zero to infinity:

$$\begin{aligned} w &= \int_0^{\infty} p dt = \int_0^{\infty} 1152e^{-4t} dt \\ &= 1152 \frac{e^{-4t}}{-4} \Big|_0^{\infty} = 288 \text{ J}. \end{aligned}$$

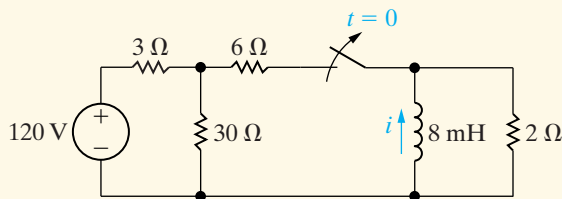
This result is the difference between the initially stored energy (320 J) and the energy trapped in the parallel inductors (32 J). The equivalent inductor for the parallel inductors (which predicts the terminal behavior of the parallel combination) has an initial energy of 288 J; that is, the energy stored in the equivalent inductor represents the amount of energy that will be delivered to the resistive network at the terminals of the original inductors.

**ASSESSMENT PROBLEMS**

**Objective 1**—Be able to determine the natural response of both *RL* and *RC* circuits

**7.1** The switch in the circuit shown has been closed for a long time and is opened at  $t = 0$ .

- a) Calculate the initial value of  $i$ .
- b) Calculate the initial energy stored in the inductor.
- c) What is the time constant of the circuit for  $t > 0$ ?
- d) What is the numerical expression for  $i(t)$  for  $t \geq 0$ ?
- e) What percentage of the initial energy stored has been dissipated in the  $2\ \Omega$  resistor 5 ms after the switch has been opened?

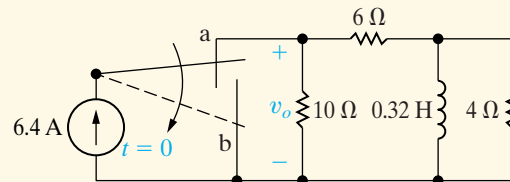


*NOTE:* Also try Chapter Problems 7.3, 7.8, and 7.9.

- Answer:** (a)  $-12.5\ \text{A}$ ;  
 (b)  $625\ \text{mJ}$ ;  
 (c)  $4\ \text{ms}$ ;  
 (d)  $-12.5e^{-250t}\ \text{A}, t \geq 0$ ;  
 (e)  $91.8\%$ .

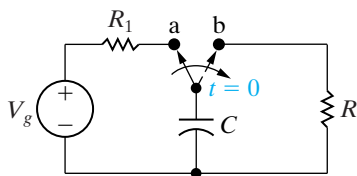
**7.2** At  $t = 0$ , the switch in the circuit shown moves instantaneously from position a to position b.

- a) Calculate  $v_o$  for  $t \geq 0^+$ .
- b) What percentage of the initial energy stored in the inductor is eventually dissipated in the  $4\ \Omega$  resistor?

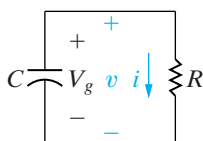


- Answer:** (a)  $-8e^{-10t}\ \text{V}, t \geq 0$ ;  
 (b)  $80\%$ .

## 7.2 The Natural Response of an *RC* Circuit



**Figure 7.10** ▲ An *RC* circuit.



**Figure 7.11** ▲ The circuit shown in Fig. 7.10, after switching.

As mentioned in Section 7.1, the natural response of an *RC* circuit is analogous to that of an *RL* circuit. Consequently, we don't treat the *RC* circuit in the same detail as we did the *RL* circuit.

The natural response of an *RC* circuit is developed from the circuit shown in Fig. 7.10. We begin by assuming that the switch has been in position a for a long time, allowing the loop made up of the dc voltage source  $V_g$ , the resistor  $R_1$ , and the capacitor  $C$  to reach a steady-state condition. Recall from Chapter 6 that a capacitor behaves as an open circuit in the presence of a constant voltage. Thus the voltage source cannot sustain a current, and so the source voltage appears across the capacitor terminals. In Section 7.3, we will discuss how the capacitor voltage actually builds to the steady-state value of the dc voltage source, but for now the important point is that when the switch is moved from position a to position b (at  $t = 0$ ), the voltage on the capacitor is  $V_g$ . Because there can be no instantaneous change in the voltage at the terminals of a capacitor, the problem reduces to solving the circuit shown in Fig. 7.11.

## Deriving the Expression for the Voltage

We can easily find the voltage  $v(t)$  by thinking in terms of node voltages. Using the lower junction between  $R$  and  $C$  as the reference node and summing the currents away from the upper junction between  $R$  and  $C$  gives

$$C \frac{dv}{dt} + \frac{v}{R} = 0. \quad (7.21)$$

Comparing Eq. 7.21 with Eq. 7.1 shows that the same mathematical techniques can be used to obtain the solution for  $v(t)$ . We leave it to you to show that

$$v(t) = v(0)e^{-t/RC}, \quad t \geq 0. \quad (7.22)$$

As we have already noted, the initial voltage on the capacitor equals the voltage source voltage  $V_g$ , or

$$v(0^-) = v(0) = v(0^+) = V_g = V_0, \quad (7.23) \quad \blacktriangleleft \text{Initial capacitor voltage}$$

where  $V_0$  denotes the initial voltage on the capacitor. The time constant for the  $RC$  circuit equals the product of the resistance and capacitance, namely,

$$\tau = RC. \quad (7.24) \quad \blacktriangleleft \text{Time constant for RC circuit}$$

Substituting Eqs. 7.23 and 7.24 into Eq. 7.22 yields

$$v(t) = V_0 e^{-t/\tau}, \quad t \geq 0, \quad (7.25) \quad \blacktriangleleft \text{Natural response of an RC circuit}$$

which indicates that the natural response of an  $RC$  circuit is an exponential decay of the initial voltage. The time constant  $RC$  governs the rate of decay. Figure 7.12 shows the plot of Eq. 7.25 and the graphic interpretation of the time constant.

After determining  $v(t)$ , we can easily derive the expressions for  $i$ ,  $p$ , and  $w$ :

$$i(t) = \frac{v(t)}{R} = \frac{V_0}{R} e^{-t/\tau}, \quad t \geq 0^+, \quad (7.26)$$

$$p = vi = \frac{V_0^2}{R} e^{-2t/\tau}, \quad t \geq 0^+, \quad (7.27)$$

$$\begin{aligned} w &= \int_0^t p \, dx = \int_0^t \frac{V_0^2}{R} e^{-2x/\tau} \, dx \\ &= \frac{1}{2} CV_0^2 (1 - e^{-2t/\tau}), \quad t \geq 0. \end{aligned} \quad (7.28)$$

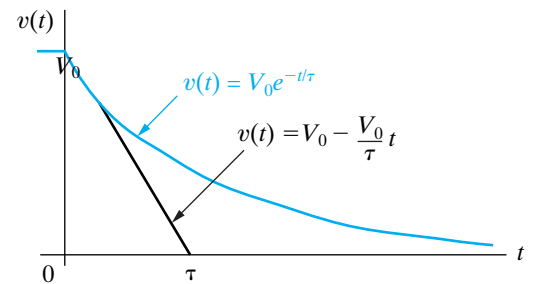


Figure 7.12 ▲ The natural response of an  $RC$  circuit.

Calculating the natural response of an  $RC$  circuit can be summarized as follows:

**Calculating the natural response of an  $RC$  circuit** ▶

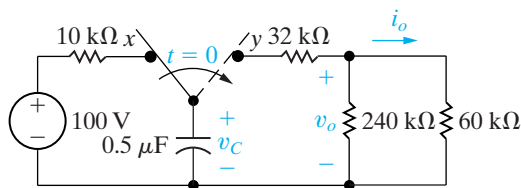
1. Find the initial voltage,  $V_0$ , across the capacitor.
2. Find the time constant of the circuit,  $\tau = RC$ .
3. Use Eq. 7.25,  $v(t) = V_0 e^{-t/\tau}$ , to generate  $v(t)$  from  $V_0$  and  $\tau$ .

All other calculations of interest follow from knowing  $v(t)$ . Examples 7.3 and 7.4 illustrate the numerical calculations associated with the natural response of an  $RC$  circuit.

**Example 7.3** Determining the Natural Response of an  $RC$  Circuit

The switch in the circuit shown in Fig. 7.13 has been in position  $x$  for a long time. At  $t = 0$ , the switch moves instantaneously to position  $y$ . Find

- a)  $v_C(t)$  for  $t \geq 0$ ,
- b)  $v_o(t)$  for  $t \geq 0^+$ ,
- c)  $i_o(t)$  for  $t \geq 0^+$ , and
- d) the total energy dissipated in the  $60 \text{ k}\Omega$  resistor.



**Figure 7.13** ▶ The circuit for Example 7.3.

**Solution**

- a) Because the switch has been in position  $x$  for a long time, the  $0.5 \text{ mF}$  capacitor will charge to  $100 \text{ V}$  and be positive at the upper terminal. We can replace the resistive network connected to the capacitor at  $t = 0^+$  with an equivalent resistance of  $80 \text{ k}\Omega$ . Hence the time constant of the circuit is  $(0.5 \times 10^{-6})(80 \times 10^3)$  or  $40 \text{ ms}$ . Then,

$$v_C(t) = 100e^{-25t} \text{ V}, \quad t \geq 0.$$

- b) The easiest way to find  $v_o(t)$  is to note that the resistive circuit forms a voltage divider across the terminals of the capacitor. Thus

$$v_o(t) = \frac{48}{80}v_C(t) = 60e^{-25t} \text{ V}, \quad t \geq 0^+.$$

This expression for  $v_o(t)$  is valid for  $t \geq 0^+$  because  $v_o(0^-)$  is zero. Thus we have an instantaneous change in the voltage across the  $240 \text{ k}\Omega$  resistor.

- c) We find the current  $i_o(t)$  from Ohm's law:

$$i_o(t) = \frac{v_o(t)}{60 \times 10^3} = e^{-25t} \text{ mA}, \quad t \geq 0^+.$$

- d) The power dissipated in the  $60 \text{ k}\Omega$  resistor is

$$p_{60\text{k}\Omega}(t) = i_o^2(t)(60 \times 10^3) = 60e^{-50t} \text{ mW}, \quad t \geq 0^+.$$

The total energy dissipated is

$$w_{60\text{k}\Omega} = \int_0^{\infty} i_o^2(t)(60 \times 10^3) dt = 1.2 \text{ mJ}.$$

**Example 7.4** Determining the Natural Response of an RC Circuit with Series Capacitors

The initial voltages on capacitors  $C_1$  and  $C_2$  in the circuit shown in Fig. 7.14 have been established by sources not shown. The switch is closed at  $t = 0$ .

- Find  $v_1(t)$ ,  $v_2(t)$ , and  $v(t)$  for  $t \geq 0$  and  $i(t)$  for  $t \geq 0^+$ .
- Calculate the initial energy stored in the capacitors  $C_1$  and  $C_2$ .
- Determine how much energy is stored in the capacitors as  $t \rightarrow \infty$ .
- Show that the total energy delivered to the 250 k $\Omega$  resistor is the difference between the results obtained in (b) and (c).

**Solution**

- Once we know  $v(t)$ , we can obtain the current  $i(t)$  from Ohm's law. After determining  $i(t)$ , we can calculate  $v_1(t)$  and  $v_2(t)$  because the voltage across a capacitor is a function of the capacitor current. To find  $v(t)$ , we replace the series-connected capacitors with an equivalent capacitor. It has a capacitance of 4  $\mu\text{F}$  and is charged to a voltage of 20 V. Therefore, the circuit shown in Fig. 7.14 reduces to the one shown in Fig. 7.15, which reveals that the initial value of  $v(t)$  is 20 V, and that the time constant of the circuit is  $(4)(250) \times 10^{-3}$ , or 1 s. Thus the expression for  $v(t)$  is

$$v(t) = 20e^{-t} \text{ V}, \quad t \geq 0.$$

The current  $i(t)$  is

$$i(t) = \frac{v(t)}{250,000} = 80e^{-t} \mu\text{A}, \quad t \geq 0^+.$$

Knowing  $i(t)$ , we calculate the expressions for  $v_1(t)$  and  $v_2(t)$ :

$$\begin{aligned} v_1(t) &= -\frac{10^6}{5} \int_0^t 80 \times 10^{-6} e^{-x} dx - 4 \\ &= (16e^{-t} - 20) \text{ V}, \quad t \geq 0, \end{aligned}$$

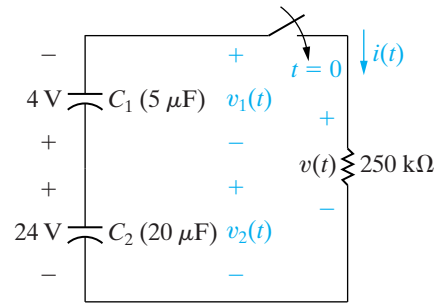
$$\begin{aligned} v_2(t) &= -\frac{10^6}{20} \int_0^t 80 \times 10^{-6} e^{-x} dx + 24 \\ &= (4e^{-t} + 20) \text{ V}, \quad t \geq 0. \end{aligned}$$

- The initial energy stored in  $C_1$  is

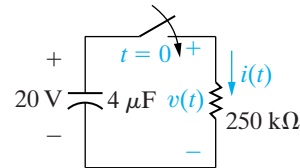
$$w_1 = \frac{1}{2}(5 \times 10^{-6})(16) = 40 \mu\text{J}.$$

The initial energy stored in  $C_2$  is

$$w_2 = \frac{1}{2}(20 \times 10^{-6})(576) = 5760 \mu\text{J}.$$



**Figure 7.14** ▲ The circuit for Example 7.4.



**Figure 7.15** ▲ A simplification of the circuit shown in Fig. 7.14.

The total energy stored in the two capacitors is

$$w_o = 40 + 5760 = 5800 \mu\text{J}.$$

- As  $t \rightarrow \infty$ ,

$$v_1 \rightarrow -20 \text{ V} \quad \text{and} \quad v_2 \rightarrow +20 \text{ V}.$$

Therefore the energy stored in the two capacitors is

$$w_\infty = \frac{1}{2}(5 + 20) \times 10^{-6}(400) = 5000 \mu\text{J}.$$

- The total energy delivered to the 250 k $\Omega$  resistor is

$$w = \int_0^\infty p dt = \int_0^\infty \frac{400e^{-2t}}{250,000} dt = 800 \mu\text{J}.$$

Comparing the results obtained in (b) and (c) shows that

$$800 \mu\text{J} = (5800 - 5000) \mu\text{J}.$$

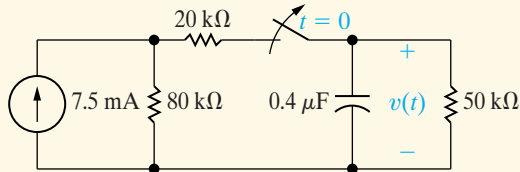
The energy stored in the equivalent capacitor in Fig. 7.15 is  $\frac{1}{2}(4 \times 10^{-6})(400)$ , or 800  $\mu\text{J}$ . Because this capacitor predicts the terminal behavior of the original series-connected capacitors, the energy stored in the equivalent capacitor is the energy delivered to the 250 k $\Omega$  resistor.

## ASSESSMENT PROBLEMS

**Objective 1**—Be able to determine the natural response of both  $RL$  and  $RC$  circuits

**7.3** The switch in the circuit shown has been closed for a long time and is opened at  $t = 0$ . Find

- the initial value of  $v(t)$ ,
- the time constant for  $t > 0$ ,
- the numerical expression for  $v(t)$  after the switch has been opened,
- the initial energy stored in the capacitor, and
- the length of time required to dissipate 75% of the initially stored energy.

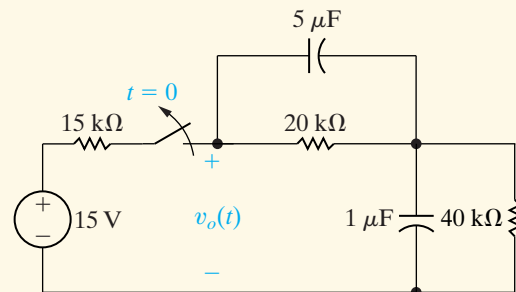


- Answer:**
- 200 V;
  - 20 ms;
  - $200e^{-50t}$  V,  $t \geq 0$ ;
  - 8 mJ;
  - 13.86 ms.

*NOTE:* Also try Chapter Problems 7.23 and 7.25.

**7.4** The switch in the circuit shown has been closed for a long time before being opened at  $t = 0$ .

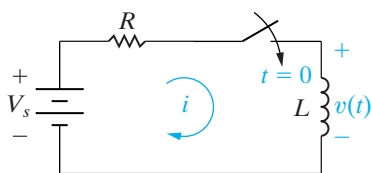
- Find  $v_o(t)$  for  $t \geq 0$ .
- What percentage of the initial energy stored in the circuit has been dissipated after the switch has been open for 60 ms?



- Answer:**
- $8e^{-25t} + 4e^{-10t}$  V,  $t \geq 0$ ;
  - 81.05%.

## 7.3 The Step Response of $RL$ and $RC$ Circuits

We are now ready to discuss the problem of finding the currents and voltages generated in first-order  $RL$  or  $RC$  circuits when either dc voltage or current sources are suddenly applied. The response of a circuit to the sudden application of a constant voltage or current source is referred to as the step response of the circuit. In presenting the step response, we show how the circuit responds when energy is being stored in the inductor or capacitor. We begin with the step response of an  $RL$  circuit.



**Figure 7.16** ▲ A circuit used to illustrate the step response of a first-order  $RL$  circuit.

### The Step Response of an $RL$ Circuit

To begin, we modify the first-order circuit shown in Fig. 7.2(a) by adding a switch. We use the resulting circuit, shown in Fig. 7.16, in developing the step response of an  $RL$  circuit. Energy stored in the inductor at the time the switch is closed is given in terms of a nonzero initial current  $i(0)$ . The task is to find the expressions for the current in the circuit and for the voltage across the inductor after the switch has been closed. The procedure is the same as that used in Section 7.1; we use circuit analysis to derive the

differential equation that describes the circuit in terms of the variable of interest, and then we use elementary calculus to solve the equation.

After the switch in Fig. 7.16 has been closed, Kirchhoff's voltage law requires that

$$V_s = Ri + L \frac{di}{dt}, \quad (7.29)$$

which can be solved for the current by separating the variables  $i$  and  $t$  and then integrating. The first step in this approach is to solve Eq. 7.29 for the derivative  $di/dt$ :

$$\frac{di}{dt} = \frac{-Ri + V_s}{L} = \frac{-R}{L} \left( i - \frac{V_s}{R} \right). \quad (7.30)$$

Next, we multiply both sides of Eq. 7.30 by a differential time  $dt$ . This step reduces the left-hand side of the equation to a differential change in the current. Thus

$$\frac{di}{dt} dt = \frac{-R}{L} \left( i - \frac{V_s}{R} \right) dt, \quad (7.31)$$

or

$$di = \frac{-R}{L} \left( i - \frac{V_s}{R} \right) dt.$$

We now separate the variables in Eq. 7.31 to get

$$\frac{di}{i - (V_s/R)} = \frac{-R}{L} dt, \quad (7.32)$$

and then integrate both sides of Eq. 7.32. Using  $x$  and  $y$  as variables for the integration, we obtain

$$\int_{I_0}^{i(t)} \frac{dx}{x - (V_s/R)} = \frac{-R}{L} \int_0^t dy, \quad (7.33)$$

where  $I_0$  is the current at  $t = 0$  and  $i(t)$  is the current at any  $t > 0$ . Performing the integration called for in Eq. 7.33 generates the expression

$$\ln \frac{i(t) - (V_s/R)}{I_0 - (V_s/R)} = \frac{-R}{L} t, \quad (7.34)$$

from which

$$\frac{i(t) - (V_s/R)}{I_0 - (V_s/R)} = e^{-(R/L)t},$$

or

$$i(t) = \frac{V_s}{R} + \left( I_0 - \frac{V_s}{R} \right) e^{-(R/L)t}. \quad (7.35) \quad \blacktriangleleft \text{Step response of } RL \text{ circuit}$$

When the initial energy in the inductor is zero,  $I_0$  is zero. Thus Eq. 7.35 reduces to

$$i(t) = \frac{V_s}{R} - \frac{V_s}{R} e^{-(R/L)t}. \quad (7.36)$$

Equation 7.36 indicates that after the switch has been closed, the current increases exponentially from zero to a final value of  $V_s/R$ . The time constant of the circuit,  $L/R$ , determines the rate of increase. One time



constant after the switch has been closed, the current will have reached approximately 63% of its final value, or

$$i(\tau) = \frac{V_s}{R} - \frac{V_s}{R}e^{-1} \approx 0.6321 \frac{V_s}{R}. \quad (7.37)$$

If the current were to continue to increase at its initial rate, it would reach its final value at  $t = \tau$ ; that is, because

$$\frac{di}{dt} = \frac{-V_s}{R} \left( \frac{-1}{\tau} \right) e^{-t/\tau} = \frac{V_s}{L} e^{-t/\tau}, \quad (7.38)$$

the initial rate at which  $i(t)$  increases is

$$\frac{di}{dt}(0) = \frac{V_s}{L}. \quad (7.39)$$

If the current were to continue to increase at this rate, the expression for  $i$  would be

$$i = \frac{V_s}{L} t, \quad (7.40)$$

from which, at  $t = \tau$ ,

$$i = \frac{V_s L}{L R} = \frac{V_s}{R}. \quad (7.41)$$

Equations 7.36 and 7.40 are plotted in Fig. 7.17. The values given by Eqs. 7.37 and 7.41 are also shown in this figure.

The voltage across an inductor is  $L di/dt$ , so from Eq. 7.35, for  $t \geq 0^+$ ,

$$v = L \left( \frac{-R}{L} \right) \left( I_0 - \frac{V_s}{R} \right) e^{-(R/L)t} = (V_s - I_0 R) e^{-(R/L)t}. \quad (7.42)$$

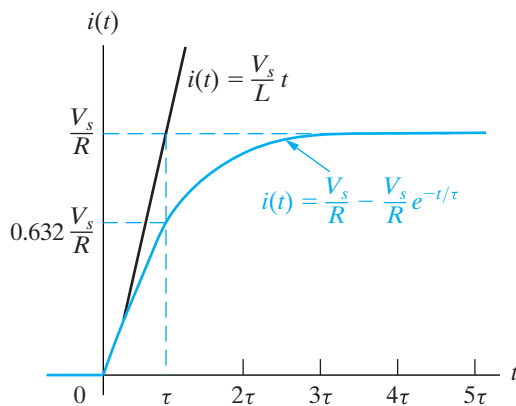
The voltage across the inductor is zero before the switch is closed. Equation 7.42 indicates that the inductor voltage jumps to  $V_s - I_0 R$  at the instant the switch is closed and then decays exponentially to zero.

Does the value of  $v$  at  $t = 0^+$  make sense? Because the initial current is  $I_0$  and the inductor prevents an instantaneous change in current, the current is  $I_0$  in the instant after the switch has been closed. The voltage drop across the resistor is  $I_0 R$ , and the voltage impressed across the inductor is the source voltage minus the voltage drop, that is,  $V_s - I_0 R$ .

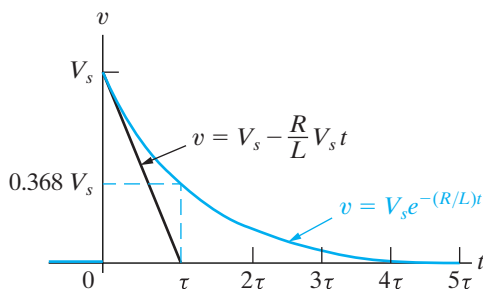
When the initial inductor current is zero, Eq. 7.42 simplifies to

$$v = V_s e^{-(R/L)t}. \quad (7.43)$$

If the initial current is zero, the voltage across the inductor jumps to  $V_s$ . We also expect the inductor voltage to approach zero as  $t$  increases, because the current in the circuit is approaching the constant value of  $V_s/R$ . Figure 7.18 shows the plot of Eq. 7.43 and the relationship between the time constant and the initial rate at which the inductor voltage is decreasing.



**Figure 7.17** ▲ The step response of the  $RL$  circuit shown in Fig. 7.16 when  $I_0 = 0$ .



**Figure 7.18** ▲ Inductor voltage versus time.

If there is an initial current in the inductor, Eq. 7.35 gives the solution for it. The algebraic sign of  $I_0$  is positive if the initial current is in the same direction as  $i$ ; otherwise,  $I_0$  carries a negative sign. Example 7.5 illustrates the application of Eq. 7.35 to a specific circuit.

### Example 7.5 Determining the Step Response of an $RL$ Circuit

The switch in the circuit shown in Fig. 7.19 has been in position a for a long time. At  $t = 0$ , the switch moves from position a to position b. The switch is a make-before-break type; that is, the connection at position b is established before the connection at position a is broken, so there is no interruption of current through the inductor.

- Find the expression for  $i(t)$  for  $t \geq 0$ .
- What is the initial voltage across the inductor just after the switch has been moved to position b?
- How many milliseconds after the switch has been moved does the inductor voltage equal 24 V?
- Does this initial voltage make sense in terms of circuit behavior?
- Plot both  $i(t)$  and  $v(t)$  versus  $t$ .

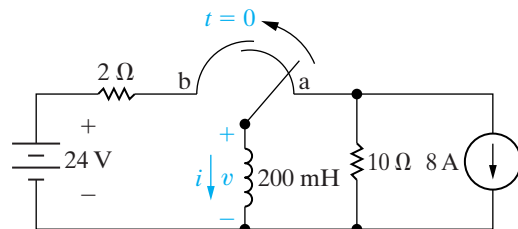


Figure 7.19 ▲ The circuit for Example 7.5.

### Solution

- The switch has been in position a for a long time, so the 200 mH inductor is a short circuit across the 8 A current source. Therefore, the inductor carries an initial current of 8 A. This current is oriented opposite to the reference direction for  $i$ ; thus  $I_0$  is  $-8$  A. When the switch is in position b, the final value of  $i$  will be  $24/2$ , or 12 A. The time constant of the circuit is  $200/2$ , or 100 ms. Substituting these values into Eq. 7.35 gives

$$\begin{aligned} i &= 12 + (-8 - 12)e^{-t/0.1} \\ &= 12 - 20e^{-10t} \text{ A}, \quad t \geq 0. \end{aligned}$$

- The voltage across the inductor is

$$\begin{aligned} v &= L \frac{di}{dt} \\ &= 0.2(200e^{-10t}) \\ &= 40e^{-10t} \text{ V}, \quad t \geq 0^+. \end{aligned}$$

The initial inductor voltage is

$$v(0^+) = 40 \text{ V}.$$

- Yes; in the instant after the switch has been moved to position b, the inductor sustains a current of 8 A counterclockwise around the newly formed closed path. This current causes a 16 V drop across the  $2 \Omega$  resistor. This voltage drop adds to the drop across the source, producing a 40 V drop across the inductor.
- We find the time at which the inductor voltage equals 24 V by solving the expression

$$24 = 40e^{-10t}$$

for  $t$ :

$$\begin{aligned} t &= \frac{1}{10} \ln \frac{40}{24} \\ &= 51.08 \times 10^{-3} \\ &= 51.08 \text{ ms}. \end{aligned}$$

- Figure 7.20 shows the graphs of  $i(t)$  and  $v(t)$  versus  $t$ . Note that the instant of time when the current equals zero corresponds to the instant of time when the inductor voltage equals the source voltage of 24 V, as predicted by Kirchhoff's voltage law.

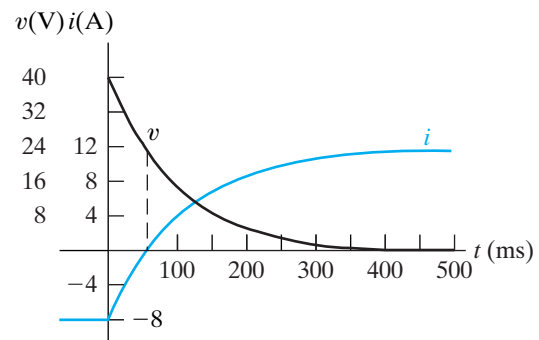


Figure 7.20 ▲ The current and voltage waveforms for Example 7.5.

## ✓ ASSESSMENT PROBLEM

### Objective 2—Be able to determine the step response of both $RL$ and $RC$ circuits

**7.5** Assume that the switch in the circuit shown in Fig. 7.19 has been in position b for a long time, and at  $t = 0$  it moves to position a. Find (a)  $i(0^+)$ ; (b)  $v(0^+)$ ; (c)  $\tau$ ,  $t > 0$ ; (d)  $i(t)$ ,  $t \geq 0$ ; and (e)  $v(t)$ ,  $t \geq 0^+$ .

**Answer:** (a) 12 A;  
(b)  $-200$  V;  
(c) 20 ms;  
(d)  $-8 + 20e^{-50t}$  A,  $t \geq 0$ ;  
(e)  $-200e^{-50t}$  V,  $t \geq 0^+$ .

*NOTE:* Also try Chapter Problems 7.35–7.37.

We can also describe the voltage  $v(t)$  across the inductor in Fig. 7.16 directly, not just in terms of the circuit current. We begin by noting that the voltage across the resistor is the difference between the source voltage and the inductor voltage. We write

$$i(t) = \frac{V_s}{R} - \frac{v(t)}{R}, \quad (7.44)$$

where  $V_s$  is a constant. Differentiating both sides with respect to time yields

$$\frac{di}{dt} = -\frac{1}{R} \frac{dv}{dt}. \quad (7.45)$$

Then, if we multiply each side of Eq. 7.45 by the inductance  $L$ , we get an expression for the voltage across the inductor on the left-hand side, or

$$v = -\frac{L}{R} \frac{dv}{dt}. \quad (7.46)$$

Putting Eq. 7.46 into standard form yields

$$\frac{dv}{dt} + \frac{R}{L} v = 0. \quad (7.47)$$

You should verify (in Problem 7.38) that the solution to Eq. 7.47 is identical to that given in Eq. 7.42.

At this point, a general observation about the step response of an  $RL$  circuit is pertinent. (This observation will prove helpful later.) When we derived the differential equation for the inductor current, we obtained Eq. 7.29. We now rewrite Eq. 7.29 as

$$\frac{di}{dt} + \frac{R}{L} i = \frac{V_s}{L}. \quad (7.48)$$

Observe that Eqs. 7.47 and 7.48 have the same form. Specifically, each equates the sum of the first derivative of the variable and a constant times the variable to a constant value. In Eq. 7.47, the constant on the right-hand side happens to be zero; hence this equation takes on the same form as the natural response equations in Section 7.1. In both Eq. 7.47 and Eq. 7.48, the constant multiplying the dependent variable is the reciprocal of the time constant, that is,  $R/L = 1/\tau$ . We encounter a similar situation in the derivations for the step response of an  $RC$  circuit. In Section 7.4, we will use these observations to develop a general approach to finding the natural and step responses of  $RL$  and  $RC$  circuits.

## The Step Response of an $RC$ Circuit

We can find the step response of a first-order  $RC$  circuit by analyzing the circuit shown in Fig. 7.21. For mathematical convenience, we choose the Norton equivalent of the network connected to the equivalent capacitor. Summing the currents away from the top node in Fig. 7.21 generates the differential equation

$$C \frac{dv_C}{dt} + \frac{v_C}{R} = I_s. \quad (7.49)$$

Division of Eq. 7.49 by  $C$  gives

$$\frac{dv_C}{dt} + \frac{v_C}{RC} = \frac{I_s}{C}. \quad (7.50)$$

Comparing Eq. 7.50 with Eq. 7.48 reveals that the form of the solution for  $v_C$  is the same as that for the current in the inductive circuit, namely, Eq. 7.35. Therefore, by simply substituting the appropriate variables and coefficients, we can write the solution for  $v_C$  directly. The translation requires that  $I_s$  replace  $V_s$ ,  $C$  replace  $L$ ,  $1/R$  replace  $R$ , and  $V_0$  replace  $I_0$ . We get

$$v_C = I_s R + (V_0 - I_s R) e^{-t/RC}, \quad t \geq 0. \quad (7.51)$$

A similar derivation for the current in the capacitor yields the differential equation

$$\frac{di}{dt} + \frac{1}{RC} i = 0. \quad (7.52)$$

Equation 7.52 has the same form as Eq. 7.47, hence the solution for  $i$  is obtained by using the same translations used for the solution of Eq. 7.50. Thus

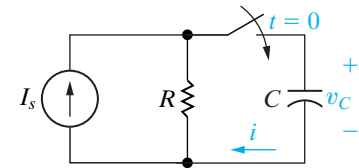
$$i = \left( I_s - \frac{V_0}{R} \right) e^{-t/RC}, \quad t \geq 0^+, \quad (7.53)$$

where  $V_0$  is the initial value of  $v_C$ , the voltage across the capacitor.

We obtained Eqs. 7.51 and 7.53 by using a mathematical analogy to the solution for the step response of the inductive circuit. Let's see whether these solutions for the  $RC$  circuit make sense in terms of known circuit behavior. From Eq. 7.51, note that the initial voltage across the capacitor is  $V_0$ , the final voltage across the capacitor is  $I_s R$ , and the time constant of the circuit is  $RC$ . Also note that the solution for  $v_C$  is valid for  $t \geq 0$ . These observations are consistent with the behavior of a capacitor in parallel with a resistor when driven by a constant current source.

Equation 7.53 predicts that the current in the capacitor at  $t = 0^+$  is  $I_s - V_0/R$ . This prediction makes sense because the capacitor voltage cannot change instantaneously, and therefore the initial current in the resistor is  $V_0/R$ . The capacitor branch current changes instantaneously from zero at  $t = 0^-$  to  $I_s - V_0/R$  at  $t = 0^+$ . The capacitor current is zero at  $t = \infty$ . Also note that the final value of  $v = I_s R$ .

Example 7.6 illustrates how to use Eqs. 7.51 and 7.53 to find the step response of a first-order  $RC$  circuit.



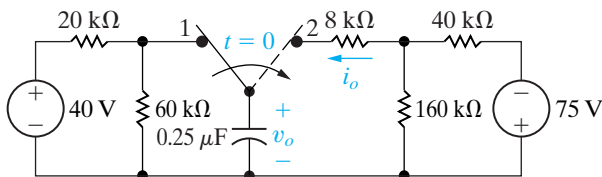
**Figure 7.21** ▲ A circuit used to illustrate the step response of a first-order  $RC$  circuit.

◀ **Step response of an  $RC$  circuit**

**Example 7.6** Determining the Step Response of an  $RC$  Circuit

The switch in the circuit shown in Fig. 7.22 has been in position 1 for a long time. At  $t = 0$ , the switch moves to position 2. Find

- $v_o(t)$  for  $t \geq 0$  and
- $i_o(t)$  for  $t \geq 0^+$ .



**Figure 7.22** ▲ The circuit for Example 7.6.

**Solution**

- The switch has been in position 1 for a long time, so the initial value of  $v_o$  is  $40(60/80)$ , or 30 V. To take advantage of Eqs. 7.51 and 7.53, we find the Norton equivalent with respect to the terminals of the capacitor for  $t \geq 0$ . To do this, we begin by computing the open-circuit voltage, which is given by the  $-75$  V source divided across the  $40$  k $\Omega$  and  $160$  k $\Omega$  resistors:

$$V_{oc} = \frac{160 \times 10^3}{(40 + 160) \times 10^3} (-75) = -60 \text{ V.}$$

Next, we calculate the Thévenin resistance, as seen to the right of the capacitor, by shorting the  $-75$  V source and making series and parallel combinations of the resistors:

$$R_{Th} = 8000 + 40,000 \parallel 160,000 = 40 \text{ k}\Omega$$

The value of the Norton current source is the ratio of the open-circuit voltage to the Thévenin resistance, or  $-60/(40 \times 10^3) = -1.5$  mA. The resulting Norton equivalent circuit is shown in Fig. 7.23. From Fig. 7.23,  $I_s R = -60$  V and  $RC = 10$  ms. We have already noted that  $v_o(0) = 30$  V, so the solution for  $v_o$  is

$$\begin{aligned} v_o &= -60 + [30 - (-60)]e^{-100t} \\ &= -60 + 90e^{-100t} \text{ V, } t \geq 0. \end{aligned}$$

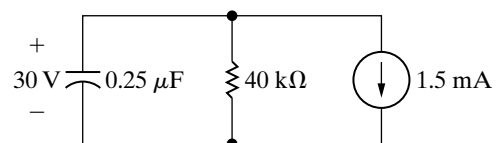
- We write the solution for  $i_o$  directly from Eq. 7.53 by noting that  $I_s = -1.5$  mA and  $V_o/R = (30/40) \times 10^{-3}$ , or 0.75 mA:

$$i_o = -2.25e^{-100t} \text{ mA, } t \geq 0^+.$$

We check the consistency of the solutions for  $v_o$  and  $i_o$  by noting that

$$\begin{aligned} i_o &= C \frac{dv_o}{dt} = (0.25 \times 10^{-6})(-9000e^{-100t}) \\ &= -2.25e^{-100t} \text{ mA.} \end{aligned}$$

Because  $dv_o(0^-)/dt = 0$ , the expression for  $i_o$  clearly is valid only for  $t \geq 0^+$ .



**Figure 7.23** ▲ The equivalent circuit for  $t > 0$  for the circuit shown in Fig. 7.22.

## ASSESSMENT PROBLEM

**Objective 2**—Be able to determine the step response of both  $RL$  and  $RC$  circuits

- 7.6 a) Find the expression for the voltage across the  $160\text{ k}\Omega$  resistor in the circuit shown in Fig. 7.22. Let this voltage be denoted  $v_A$ , and assume that the reference polarity for the voltage is positive at the upper terminal of the  $160\text{ k}\Omega$  resistor.
- b) Specify the interval of time for which the expression obtained in (a) is valid.

**Answer:** (a)  $-60 + 72e^{-100t}\text{ V}$ ;  
(b)  $t \geq 0^+$ .

*NOTE:* Also try Chapter Problems 7.53 and 7.54.

## 7.4 A General Solution for Step and Natural Responses

The general approach to finding either the natural response or the step response of the first-order  $RL$  and  $RC$  circuits shown in Fig. 7.24 is based on their differential equations having the same form (compare Eq. 7.48 and Eq. 7.50). To generalize the solution of these four possible circuits, we let  $x(t)$  represent the unknown quantity, giving  $x(t)$  four possible values. It can represent the current or voltage at the terminals of an inductor or the current or voltage at the terminals of a capacitor. From Eqs. 7.47, 7.48, 7.50, and 7.52, we know that the differential equation describing any one of the four circuits in Fig. 7.24 takes the form

$$\frac{dx}{dt} + \frac{x}{\tau} = K, \quad (7.54)$$

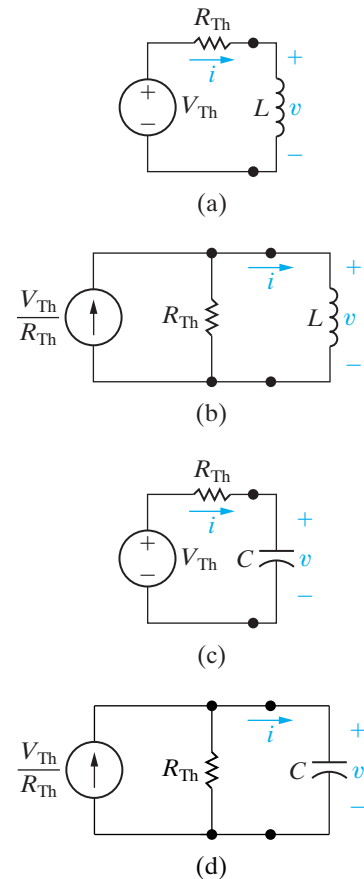
where the value of the constant  $K$  can be zero. Because the sources in the circuit are constant voltages and/or currents, the final value of  $x$  will be constant; that is, the final value must satisfy Eq. 7.54, and, when  $x$  reaches its final value, the derivative  $dx/dt$  must be zero. Hence

$$x_f = K\tau, \quad (7.55)$$

where  $x_f$  represents the final value of the variable.

We solve Eq. 7.54 by separating the variables, beginning by solving for the first derivative:

$$\frac{dx}{dt} = \frac{-x}{\tau} + K = \frac{-(x - K\tau)}{\tau} = \frac{-(x - x_f)}{\tau}. \quad (7.56)$$



**Figure 7.24** ▲ Four possible first-order circuits. (a) An inductor connected to a Thévenin equivalent. (b) An inductor connected to a Norton equivalent. (c) A capacitor connected to a Thévenin equivalent. (d) A capacitor connected to a Norton equivalent.

In writing Eq. 7.56, we used Eq. 7.55 to substitute  $x_f$  for  $K\tau$ . We now multiply both sides of Eq. 7.56 by  $dt$  and divide by  $x - x_f$  to obtain

$$\frac{dx}{x - x_f} = \frac{-1}{\tau} dt. \quad (7.57)$$

Next, we integrate Eq. 7.57. To obtain as general a solution as possible, we use time  $t_0$  as the lower limit and  $t$  as the upper limit. Time  $t_0$  corresponds to the time of the switching or other change. Previously we assumed that  $t_0 = 0$ , but this change allows the switching to take place at any time. Using  $u$  and  $v$  as symbols of integration, we get

$$\int_{x(t_0)}^{x(t)} \frac{du}{u - x_f} = -\frac{1}{\tau} \int_{t_0}^t dv. \quad (7.58)$$

Carrying out the integration called for in Eq. 7.58 gives

**General solution for natural and step responses of *RL* and *RC* circuits ►**

$$x(t) = x_f + [x(t_0) - x_f]e^{-(t-t_0)/\tau}. \quad (7.59)$$

The importance of Eq. 7.59 becomes apparent if we write it out in words:

the unknown      the final  
variable as a      = value of the  
function of time      variable

$$+ \left[ \begin{array}{cc} \text{the initial} & \text{the final} \\ \text{value of the} & \text{value of the} \\ \text{variable} & \text{variable} \end{array} \right] \times e^{-\frac{[t - (\text{time of switching})]}{(\text{time constant})}} \quad (7.60)$$

In many cases, the time of switching—that is,  $t_0$ —is zero.

When computing the step and natural responses of circuits, it may help to follow these steps:

**Calculating the natural or step response of *RL* or *RC* circuits ►**

1. Identify the variable of interest for the circuit. For *RC* circuits, it is most convenient to choose the capacitive voltage; for *RL* circuits, it is best to choose the inductive current.
2. Determine the initial value of the variable, which is its value at  $t_0$ . Note that if you choose capacitive voltage or inductive current as your variable of interest, it is not necessary to distinguish between  $t = t_0^-$  and  $t = t_0^+$ .<sup>2</sup> This is because they both are continuous variables. If you choose another variable, you need to remember that its initial value is defined at  $t = t_0^+$ .
3. Calculate the final value of the variable, which is its value as  $t \rightarrow \infty$ .
4. Calculate the time constant for the circuit.

With these quantities, you can use Eq. 7.60 to produce an equation describing the variable of interest as a function of time. You can then find equations for other circuit variables using the circuit analysis techniques introduced in Chapters 3 and 4 or by repeating the preceding steps for the other variables.

Examples 7.7–7.9 illustrate how to use Eq. 7.60 to find the step response of an *RC* or *RL* circuit.

<sup>2</sup> The expressions  $t_0^-$  and  $t_0^+$  are analogous to  $0^-$  and  $0^+$ . Thus  $x(t_0^-)$  is the limit of  $x(t)$  as  $t \rightarrow t_0$  from the left, and  $x(t_0^+)$  is the limit of  $x(t)$  as  $t \rightarrow t_0$  from the right.



**Example 7.7** Using the General Solution Method to Find an RC Circuit's Step Response

The switch in the circuit shown in Fig. 7.25 has been in position a for a long time. At  $t = 0$  the switch is moved to position b.

- What is the initial value of  $v_C$ ?
- What is the final value of  $v_C$ ?
- What is the time constant of the circuit when the switch is in position b?
- What is the expression for  $v_C(t)$  when  $t \geq 0$ ?
- What is the expression for  $i(t)$  when  $t \geq 0^+$ ?
- How long after the switch is in position b does the capacitor voltage equal zero?
- Plot  $v_C(t)$  and  $i(t)$  versus  $t$ .

**Solution**

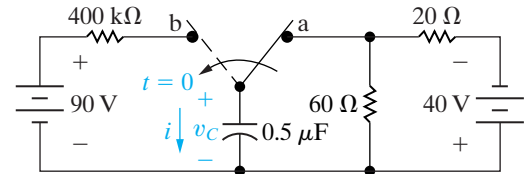
- The switch has been in position a for a long time, so the capacitor looks like an open circuit. Therefore the voltage across the capacitor is the voltage across the  $60\ \Omega$  resistor. From the voltage-divider rule, the voltage across the  $60\ \Omega$  resistor is  $40 \times [60/(60 + 20)]$ , or 30 V. As the reference for  $v_C$  is positive at the upper terminal of the capacitor, we have  $v_C(0) = -30$  V.
- After the switch has been in position b for a long time, the capacitor will look like an open circuit in terms of the 90 V source. Thus the final value of the capacitor voltage is +90 V.
- The time constant is

$$\begin{aligned}\tau &= RC \\ &= (400 \times 10^3)(0.5 \times 10^{-6}) \\ &= 0.2\ \text{s}.\end{aligned}$$

- Substituting the appropriate values for  $v_f$ ,  $v(0)$ , and  $t$  into Eq. 7.60 yields

$$\begin{aligned}v_C(t) &= 90 + (-30 - 90)e^{-5t} \\ &= 90 - 120e^{-5t}\ \text{V}, \quad t \geq 0.\end{aligned}$$

- Here the value for  $\tau$  doesn't change. Thus we need to find only the initial and final values for the current in the capacitor. When obtaining the initial value, we must get the value of  $i(0^+)$ , because the current in the capacitor can change instantaneously. This current is equal to the current in the resistor, which from Ohm's law is  $[90 - (-30)]/(400 \times 10^3) = 300\ \mu\text{A}$ . Note that when applying Ohm's law we recognized that the



**Figure 7.25** ▲ The circuit for Example 7.7.

capacitor voltage cannot change instantaneously. The final value of  $i(t) = 0$ , so

$$\begin{aligned}i(t) &= 0 + (300 - 0)e^{-5t} \\ &= 300e^{-5t}\ \mu\text{A}, \quad t \geq 0^+.\end{aligned}$$

We could have obtained this solution by differentiating the solution in (d) and multiplying by the capacitance. You may want to do so for yourself. Note that this alternative approach to finding  $i(t)$  also predicts the discontinuity at  $t = 0$ .

- To find how long the switch must be in position b before the capacitor voltage becomes zero, we solve the equation derived in (d) for the time when  $v_C(t) = 0$ :

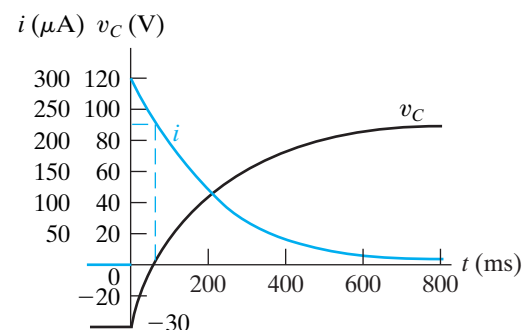
$$120e^{-5t} = 90 \quad \text{or} \quad e^{5t} = \frac{120}{90},$$

so

$$\begin{aligned}t &= \frac{1}{5} \ln\left(\frac{4}{3}\right) \\ &= 57.54\ \text{ms}.\end{aligned}$$

Note that when  $v_C = 0$ ,  $i = 225\ \mu\text{A}$  and the voltage drop across the  $400\ \text{k}\Omega$  resistor is 90 V.

- Figure 7.26 shows the graphs of  $v_C(t)$  and  $i(t)$  versus  $t$ .

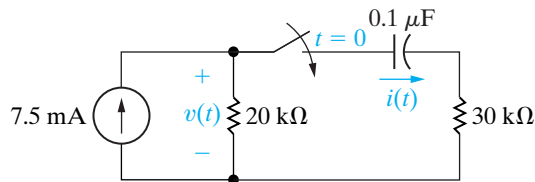


**Figure 7.26** ▲ The current and voltage waveforms for Example 7.7.

**Example 7.8** Using the General Solution Method with Zero Initial Conditions

The switch in the circuit shown in Fig. 7.27 has been open for a long time. The initial charge on the capacitor is zero. At  $t = 0$ , the switch is closed. Find the expression for

- $i(t)$  for  $t \geq 0^+$  and
- $v(t)$  when  $t \geq 0^+$ .



**Figure 7.27** ▲ The circuit for Example 7.8.

**Solution**

- Because the initial voltage on the capacitor is zero, at the instant when the switch is closed the current in the  $30\text{ k}\Omega$  branch will be

$$\begin{aligned} i(0^+) &= \frac{(7.5)(20)}{50} \\ &= 3\text{ mA}. \end{aligned}$$

The final value of the capacitor current will be zero because the capacitor eventually will appear as an open circuit in terms of dc current. Thus  $i_f = 0$ . The time constant of the circuit will equal the product of the Thévenin resistance (as seen from the capacitor) and the capacitance.

Therefore  $\tau = (20 + 30)10^3(0.1) \times 10^{-6} = 5\text{ ms}$ . Substituting these values into Eq. 7.60 generates the expression

$$\begin{aligned} i(t) &= 0 + (3 - 0)e^{-t/5 \times 10^{-3}} \\ &= 3e^{-200t}\text{ mA}, \quad t \geq 0^+. \end{aligned}$$

- To find  $v(t)$ , we note from the circuit that it equals the sum of the voltage across the capacitor and the voltage across the  $30\text{ k}\Omega$  resistor. To find the capacitor voltage (which is a drop in the direction of the current), we note that its initial value is zero and its final value is  $(7.5)(20)$ , or  $150\text{ V}$ . The time constant is the same as before, or  $5\text{ ms}$ . Therefore we use Eq. 7.60 to write

$$\begin{aligned} v_C(t) &= 150 + (0 - 150)e^{-200t} \\ &= (150 - 150e^{-200t})\text{ V}, \quad t \geq 0. \end{aligned}$$

Hence the expression for the voltage  $v(t)$  is

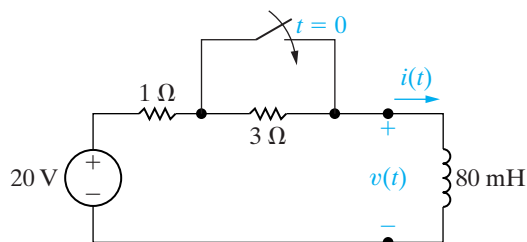
$$\begin{aligned} v(t) &= 150 - 150e^{-200t} + (30)(3)e^{-200t} \\ &= (150 - 60e^{-200t})\text{ V}, \quad t \geq 0^+. \end{aligned}$$

As one check on this expression, note that it predicts the initial value of the voltage across the  $20\text{ k}\Omega$  resistor as  $150 - 60$ , or  $90\text{ V}$ . The instant the switch is closed, the current in the  $20\text{ k}\Omega$  resistor is  $(7.5)(30/50)$ , or  $4.5\text{ mA}$ . This current produces a  $90\text{ V}$  drop across the  $20\text{ k}\Omega$  resistor, confirming the value predicted by the solution.

**Example 7.9** Using the General Solution Method to Find an  $RL$  Circuit's Step Response

The switch in the circuit shown in Fig. 7.28 has been open for a long time. At  $t = 0$  the switch is closed. Find the expression for

- $v(t)$  when  $t \geq 0^+$  and
- $i(t)$  when  $t \geq 0$ .



**Figure 7.28** ▲ The circuit for Example 7.9.

**Solution**

- The switch has been open for a long time, so the initial current in the inductor is  $5\text{ A}$ , oriented from top to bottom. Immediately after the switch closes, the current still is  $5\text{ A}$ , and therefore the initial voltage across the inductor becomes  $20 - 5(1)$ , or  $15\text{ V}$ . The final value of the inductor voltage is  $0\text{ V}$ . With the switch closed, the time constant is  $80/1$ , or  $80\text{ ms}$ . We use Eq. 7.60 to write the expression for  $v(t)$ :

$$\begin{aligned} v(t) &= 0 + (15 - 0)e^{-t/80 \times 10^{-3}} \\ &= 15e^{-12.5t}\text{ V}, \quad t \geq 0^+. \end{aligned}$$

- We have already noted that the initial value of the inductor current is  $5\text{ A}$ . After the switch has

been closed for a long time, the inductor current reaches 20/1, or 20 A. The circuit time constant is 80 ms, so the expression for  $i(t)$  is

$$\begin{aligned} i(t) &= 20 + (5 - 20)e^{-12.5t} \\ &= (20 - 15e^{-12.5t}) \text{ A}, \quad t \geq 0. \end{aligned}$$

**NOTE:** Assess your understanding of the general solution method by trying Chapter Problems 7.51 and 7.53.

We determine that the solutions for  $v(t)$  and  $i(t)$  agree by noting that

$$\begin{aligned} v(t) &= L \frac{di}{dt} \\ &= 80 \times 10^{-3} [15(12.5)e^{-12.5t}] \\ &= 15e^{-12.5t} \text{ V}, \quad t \geq 0^+. \end{aligned}$$

Example 7.10 shows that Eq. 7.60 can even be used to find the step response of some circuits containing magnetically coupled coils.

### Example 7.10 Determining Step Response of a Circuit with Magnetically Coupled Coils

There is no energy stored in the circuit in Fig. 7.29 at the time the switch is closed.

- Find the solutions for  $i_o$ ,  $v_o$ ,  $i_1$ , and  $i_2$ .
- Show that the solutions obtained in (a) make sense in terms of known circuit behavior.

#### Solution

- For the circuit in Fig. 7.29, the magnetically coupled coils can be replaced by a single inductor having an inductance of

$$L_{\text{eq}} = \frac{L_1 L_2 - M^2}{L_1 + L_2 - 2M} = \frac{45 - 36}{18 - 12} = 1.5 \text{ H}.$$

(See Problem 6.41.) It follows that the circuit in Fig. 7.29 can be simplified as shown in Fig. 7.30.

By hypothesis the initial value of  $i_o$  is zero. From Fig. 7.30 we see that the final value of  $i_o$  will be 120/7.5 or 16 A. The time constant of the circuit is 1.5/7.5 or 0.2 s. It follows directly from Eq. 7.60 that

$$i_o = 16 - 16e^{-5t} \text{ A}, \quad t \geq 0.$$

The voltage  $v_o$  follows from Kirchhoff's voltage law. Thus,

$$\begin{aligned} v_o &= 120 - 7.5i_o \\ &= 120e^{-5t} \text{ V}, \quad t \geq 0^+. \end{aligned}$$

To find  $i_1$  and  $i_2$  we first note from Fig. 7.29 that

$$3 \frac{di_1}{dt} + 6 \frac{di_2}{dt} = 6 \frac{di_1}{dt} + 15 \frac{di_2}{dt}$$

or

$$\frac{di_1}{dt} = -3 \frac{di_2}{dt}.$$

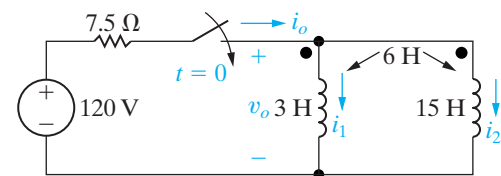


Figure 7.29 ▲ The circuit for Example 7.10.

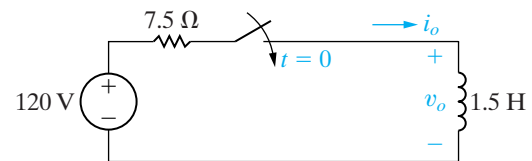


Figure 7.30 ▲ The circuit in Fig. 7.29 with the magnetically coupled coils replaced by an equivalent coil.

It also follows from Fig. 7.29 that because  $i_o = i_1 + i_2$ ,

$$\frac{di_o}{dt} = \frac{di_1}{dt} + \frac{di_2}{dt}.$$

Therefore

$$80e^{-5t} = -2 \frac{di_2}{dt}.$$

Because  $i_2(0)$  is zero we have

$$\begin{aligned} i_2 &= \int_0^t -40e^{-5x} dx \\ &= -8 + 8e^{-5t} \text{ A}, \quad t \geq 0. \end{aligned}$$

Using Kirchhoff's current law we get

$$i_1 = 24 - 24e^{-5t} \text{ A}, \quad t \geq 0.$$

- First we observe that  $i_o(0)$ ,  $i_1(0)$ , and  $i_2(0)$  are all zero, which is consistent with the statement that

no energy is stored in the circuit at the instant the switch is closed.

Next we observe  $v_o(0^+) = 120$  V, which is consistent with the fact that  $i_o(0) = 0$ .

Now we observe the solutions for  $i_1$  and  $i_2$  are consistent with the solution for  $v_o$  by observing

$$\begin{aligned} v_o &= 3 \frac{di_1}{dt} + 6 \frac{di_2}{dt} \\ &= 360e^{-5t} - 240e^{-5t} \\ &= 120e^{-5t} \text{ V}, \quad t \geq 0^+, \end{aligned}$$

or

$$\begin{aligned} v_o &= 6 \frac{di_1}{dt} + 15 \frac{di_2}{dt} \\ &= 720e^{-5t} - 600e^{-5t} \\ &= 120e^{-5t} \text{ V}, \quad t \geq 0^+. \end{aligned}$$

The final values of  $i_1$  and  $i_2$  can be checked using flux linkages. The flux linking the 3 H coil ( $\lambda_1$ ) must be equal to the flux linking the 15 H coil ( $\lambda_2$ ), because

$$\begin{aligned} v_o &= \frac{d\lambda_1}{dt} \\ &= \frac{d\lambda_2}{dt}. \end{aligned}$$

Now

$$\lambda_1 = 3i_1 + 6i_2 \text{ Wb-turns}$$

and

$$\lambda_2 = 6i_1 + 15i_2 \text{ Wb-turns.}$$

**NOTE:** Assess your understanding of this material by using the general solution method to solve Chapter Problems 7.68 and 7.71.

Regardless of which expression we use, we obtain

$$\lambda_1 = \lambda_2 = 24 - 24e^{-5t} \text{ Wb-turns.}$$

Note the solution for  $\lambda_1$  or  $\lambda_2$  is consistent with the solution for  $v_o$ .

The final value of the flux linking either coil 1 or coil 2 is 24 Wb-turns, that is,

$$\lambda_1(\infty) = \lambda_2(\infty) = 24 \text{ Wb-turns.}$$

The final value of  $i_1$  is

$$i_1(\infty) = 24 \text{ A}$$

and the final value of  $i_2$  is

$$i_2(\infty) = -8 \text{ A.}$$

The consistency between these final values for  $i_1$  and  $i_2$  and the final value of the flux linkage can be seen from the expressions:

$$\begin{aligned} \lambda_1(\infty) &= 3i_1(\infty) + 6i_2(\infty) \\ &= 3(24) + 6(-8) = 24 \text{ Wb-turns,} \\ \lambda_2(\infty) &= 6i_1(\infty) + 15i_2(\infty) \\ &= 6(24) + 15(-8) = 24 \text{ Wb-turns.} \end{aligned}$$

It is worth noting that the final values of  $i_1$  and  $i_2$  can only be checked via flux linkage because at  $t = \infty$  the two coils are ideal short circuits. The division of current between ideal short circuits cannot be found from Ohm's law.

## 7.5 Sequential Switching

Whenever switching occurs more than once in a circuit, we have **sequential switching**. For example, a single, two-position switch may be switched back and forth, or multiple switches may be opened or closed in sequence. The time reference for all switchings cannot be  $t = 0$ . We determine the voltages and currents generated by a switching sequence by using the techniques described previously in this chapter. We derive the expressions for  $v(t)$  and  $i(t)$  for a given position of the switch or switches and then use these solutions to determine the initial conditions for the next position of the switch or switches.

With sequential switching problems, a premium is placed on obtaining the initial value  $x(t_0)$ . Recall that anything but inductive currents and capacitive voltages can change instantaneously at the time of switching. Thus solving first for inductive currents and capacitive voltages is even more pertinent in sequential switching problems. Drawing the circuit that pertains to each time interval in such a problem is often helpful in the solution process.

Examples 7.11 and 7.12 illustrate the analysis techniques for circuits with sequential switching. The first is a natural response problem with two switching times, and the second is a step response problem.

### Example 7.11 Analyzing an $RL$ Circuit that has Sequential Switching

The two switches in the circuit shown in Fig. 7.31 have been closed for a long time. At  $t = 0$ , switch 1 is opened. Then, 35 ms later, switch 2 is opened.

- Find  $i_L(t)$  for  $0 \leq t \leq 35$  ms.
- Find  $i_L$  for  $t \geq 35$  ms.
- What percentage of the initial energy stored in the 150 mH inductor is dissipated in the 18  $\Omega$  resistor?
- Repeat (c) for the 3  $\Omega$  resistor.
- Repeat (c) for the 6  $\Omega$  resistor.

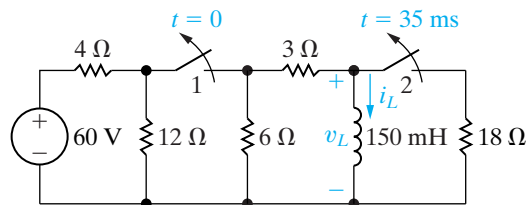


Figure 7.31 ▲ The circuit for Example 7.11.

### Solution

- For  $t < 0$  both switches are closed, causing the 150 mH inductor to short-circuit the 18  $\Omega$  resistor. The equivalent circuit is shown in Fig. 7.32. We determine the initial current in the inductor by solving for  $i_L(0^-)$  in the circuit shown in Fig. 7.32. After making several source transformations, we find  $i_L(0^-)$  to be 6 A. For  $0 \leq t \leq 35$  ms, switch 1 is open (switch 2 is closed), which disconnects the 60 V voltage source and the 4  $\Omega$  and 12  $\Omega$  resistors from the circuit. The inductor is no longer behaving as a short circuit (because the dc source is no longer in the circuit), so the 18  $\Omega$  resistor is no longer short-circuited. The equivalent circuit is shown in Fig. 7.33. Note that the equivalent resistance across the terminals of the inductor is the parallel combination of 9  $\Omega$  and 18  $\Omega$ , or 6  $\Omega$ . The time constant of the circuit is  $(150/6) \times 10^{-3}$ , or 25 ms. Therefore the expression for  $i_L$  is

$$i_L = 6e^{-40t} \text{ A}, \quad 0 \leq t \leq 35 \text{ ms.}$$

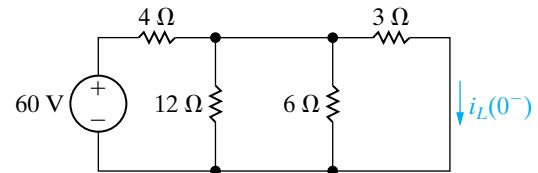


Figure 7.32 ▲ The circuit shown in Fig. 7.31, for  $t < 0$ .

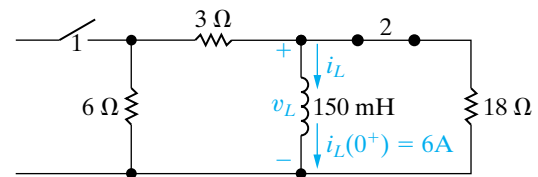


Figure 7.33 ▲ The circuit shown in Fig. 7.31, for  $0 \leq t \leq 35$  ms.

- When  $t = 35$  ms, the value of the inductor current is

$$i_L = 6e^{-1.4} = 1.48 \text{ A.}$$

Thus, when switch 2 is opened, the circuit reduces to the one shown in Fig. 7.34, and the time constant changes to  $(150/9) \times 10^{-3}$ , or 16.67 ms. The expression for  $i_L$  becomes

$$i_L = 1.48e^{-60(t-0.035)} \text{ A}, \quad t \geq 35 \text{ ms.}$$

Note that the exponential function is shifted in time by 35 ms.

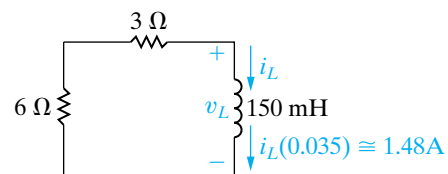


Figure 7.34 ▲ The circuit shown in Fig. 7.31, for  $t \geq 35$  ms.

- The 18  $\Omega$  resistor is in the circuit only during the first 35 ms of the switching sequence. During this interval, the voltage across the resistor is

$$\begin{aligned} v_L &= 0.15 \frac{d}{dt} (6e^{-40t}) \\ &= -36e^{-40t} \text{ V}, \quad 0 < t < 35 \text{ ms.} \end{aligned}$$

The power dissipated in the  $18\ \Omega$  resistor is

$$p = \frac{v_L^2}{18} = 72e^{-80t}\ \text{W}, \quad 0 < t < 35\ \text{ms}.$$

Hence the energy dissipated is

$$\begin{aligned} w &= \int_0^{0.035} 72e^{-80t} dt \\ &= \left. \frac{72}{-80} e^{-80t} \right|_0^{0.035} \\ &= 0.9(1 - e^{-2.8}) \\ &= 845.27\ \text{mJ}. \end{aligned}$$

The initial energy stored in the  $150\ \text{mH}$  inductor is

$$w_i = \frac{1}{2}(0.15)(36) = 2.7\ \text{J} = 2700\ \text{mJ}.$$

Therefore  $(845.27/2700) \times 100$ , or  $31.31\%$  of the initial energy stored in the  $150\ \text{mH}$  inductor is dissipated in the  $18\ \Omega$  resistor.

- d) For  $0 < t < 35\ \text{ms}$ , the voltage across the  $3\ \Omega$  resistor is

$$\begin{aligned} v_{3\Omega} &= \left( \frac{v_L}{9} \right) (3) \\ &= \frac{1}{3} v_L \\ &= -12e^{-40t}\ \text{V}. \end{aligned}$$

Therefore the energy dissipated in the  $3\ \Omega$  resistor in the first  $35\ \text{ms}$  is

$$\begin{aligned} w_{3\Omega} &= \int_0^{0.035} \frac{144e^{-80t}}{3} dt \\ &= 0.6(1 - e^{-2.8}) \\ &= 563.51\ \text{mJ}. \end{aligned}$$

For  $t > 35\ \text{ms}$ , the current in the  $3\ \Omega$  resistor is

$$i_{3\Omega} = i_L = (6e^{-1.4})e^{-60(t-0.035)}\ \text{A}.$$

Hence the energy dissipated in the  $3\ \Omega$  resistor for  $t > 35\ \text{ms}$  is

$$\begin{aligned} w_{3\Omega} &= \int_{0.035}^{\infty} i_{3\Omega}^2 \times 3 dt \\ &= \int_{0.035}^{\infty} 3(36)e^{-2.8} e^{-120(t-0.035)} dt \\ &= 108e^{-2.8} \times \left. \frac{e^{-120(t-0.035)}}{-120} \right|_{0.035}^{\infty} \\ &= \frac{108}{120} e^{-2.8} = 54.73\ \text{mJ}. \end{aligned}$$

The total energy dissipated in the  $3\ \Omega$  resistor is

$$\begin{aligned} w_{3\Omega}(\text{total}) &= 563.51 + 54.73 \\ &= 618.24\ \text{mJ}. \end{aligned}$$

The percentage of the initial energy stored is

$$\frac{618.24}{2700} \times 100 = 22.90\%.$$

- e) Because the  $6\ \Omega$  resistor is in series with the  $3\ \Omega$  resistor, the energy dissipated and the percentage of the initial energy stored will be twice that of the  $3\ \Omega$  resistor:

$$w_{6\Omega}(\text{total}) = 1236.48\ \text{mJ},$$

and the percentage of the initial energy stored is  $45.80\%$ . We check these calculations by observing that

$$1236.48 + 618.24 + 845.27 = 2699.99\ \text{mJ}$$

and

$$31.31 + 22.90 + 45.80 = 100.01\%.$$

The small discrepancies in the summations are the result of roundoff errors.

**Example 7.12** Analyzing an RC Circuit that has Sequential Switching

The uncharged capacitor in the circuit shown in Fig. 7.35 is initially switched to terminal a of the three-position switch. At  $t = 0$ , the switch is moved to position b, where it remains for 15 ms. After the 15 ms delay, the switch is moved to position c, where it remains indefinitely.

- Derive the numerical expression for the voltage across the capacitor.
- Plot the capacitor voltage versus time.
- When will the voltage on the capacitor equal 200 V?

**Solution**

- At the instant the switch is moved to position b, the initial voltage on the capacitor is zero. If the switch were to remain in position b, the capacitor would eventually charge to 400 V. The time constant of the circuit when the switch is in position b is 10 ms. Therefore we can use Eq. 7.59 with  $t_0 = 0$  to write the expression for the capacitor voltage:

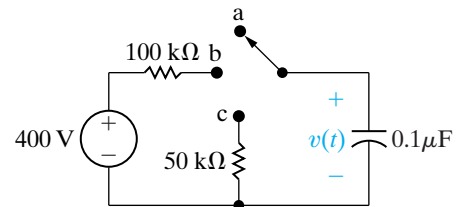
$$\begin{aligned} v &= 400 + (0 - 400)e^{-100t} \\ &= (400 - 400e^{-100t}) \text{ V}, \quad 0 \leq t \leq 15 \text{ ms.} \end{aligned}$$

Note that, because the switch remains in position b for only 15 ms, this expression is valid only for the time interval from 0 to 15 ms. After the switch has been in this position for 15 ms, the voltage on the capacitor will be

$$v(15 \text{ ms}) = 400 - 400e^{-1.5} = 310.75 \text{ V.}$$

Therefore, when the switch is moved to position c, the initial voltage on the capacitor is 310.75 V. With the switch in position c, the final value of the capacitor voltage is zero, and the time constant is 5 ms. Again, we use Eq. 7.59 to write the expression for the capacitor voltage:

$$\begin{aligned} v &= 0 + (310.75 - 0)e^{-200(t-0.015)} \\ &= 310.75e^{-200(t-0.015)} \text{ V}, \quad 15 \text{ ms} \leq t. \end{aligned}$$



**Figure 7.35** ▲ The circuit for Example 7.12.

In writing the expression for  $v$ , we recognized that  $t_0 = 15$  ms and that this expression is valid only for  $t \geq 15$  ms.

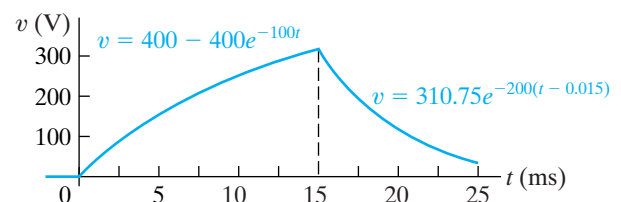
- Figure 7.36 shows the plot of  $v$  versus  $t$ .
- The plot in Fig. 7.36 reveals that the capacitor voltage will equal 200 V at two different times: once in the interval between 0 and 15 ms and once after 15 ms. We find the first time by solving the expression

$$200 = 400 - 400e^{-100t_1},$$

which yields  $t_1 = 6.93$  ms. We find the second time by solving the expression

$$200 = 310.75e^{-200(t_2-0.015)}.$$

In this case,  $t_2 = 17.20$  ms.



**Figure 7.36** ▲ The capacitor voltage for Example 7.12.

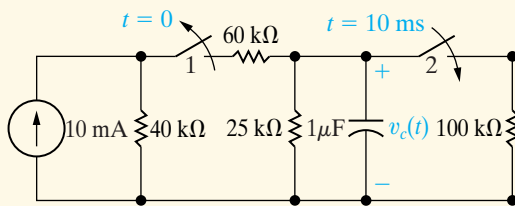


## ASSESSMENT PROBLEMS

### Objective 3—Know how to analyze circuits with sequential switching

**7.7** In the circuit shown, switch 1 has been closed and switch 2 has been open for a long time. At  $t = 0$ , switch 1 is opened. Then 10 ms later, switch 2 is closed. Find

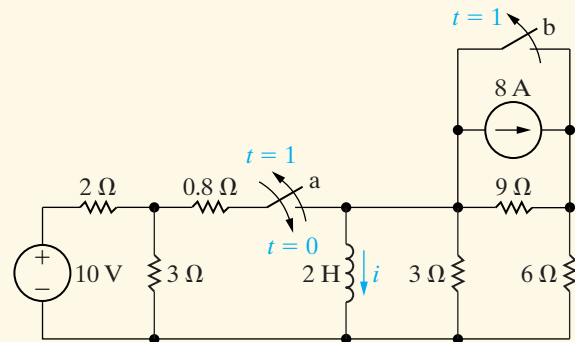
- $v_c(t)$  for  $0 \leq t \leq 0.01$  s,
- $v_c(t)$  for  $t \geq 0.01$  s,
- the total energy dissipated in the  $25 \text{ k}\Omega$  resistor, and
- the total energy dissipated in the  $100 \text{ k}\Omega$  resistor.



- Answer:** (a)  $80e^{-40t}$  V;  
 (b)  $53.63e^{-50(t-0.01)}$  V;  
 (c) 2.91 mJ;  
 (d) 0.29 mJ.

**NOTE:** Also try Chapter Problems 7.72 and 7.80.

**7.8** Switch a in the circuit shown has been open for a long time, and switch b has been closed for a long time. Switch a is closed at  $t = 0$  and, after remaining closed for 1 s, is opened again. Switch b is opened simultaneously, and both switches remain open indefinitely. Determine the expression for the inductor current  $i$  that is valid when (a)  $0 \leq t \leq 1$  s and (b)  $t \geq 1$  s.



- Answer:** (a)  $(3 - 3e^{-0.5t})$  A,  $0 \leq t \leq 1$  s;  
 (b)  $(-4.8 + 5.98e^{-1.25(t-1)})$  A,  $t \geq 1$  s.

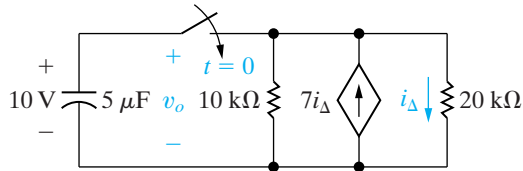
## 7.6 Unbounded Response

A circuit response may grow, rather than decay, exponentially with time. This type of response, called an **unbounded response**, is possible if the circuit contains dependent sources. In that case, the Thévenin equivalent resistance with respect to the terminals of either an inductor or a capacitor may be negative. This negative resistance generates a negative time constant, and the resulting currents and voltages increase without limit. In an actual circuit, the response eventually reaches a limiting value when a component breaks down or goes into a saturation state, prohibiting further increases in voltage or current.

When we consider unbounded responses, the concept of a final value is confusing. Hence, rather than using the step response solution given in Eq. 7.59, we derive the differential equation that describes the circuit containing the negative resistance and then solve it using the separation of variables technique. Example 7.13 presents an exponentially growing response in terms of the voltage across a capacitor.

**Example 7.13** Finding the Unbounded Response in an RC Circuit

- a) When the switch is closed in the circuit shown in Fig. 7.37, the voltage on the capacitor is 10 V. Find the expression for  $v_o$  for  $t \geq 0$ .
- b) Assume that the capacitor short-circuits when its terminal voltage reaches 150 V. How many milliseconds elapse before the capacitor short-circuits?



**Figure 7.37** ▲ The circuit for Example 7.13.

**Solution**

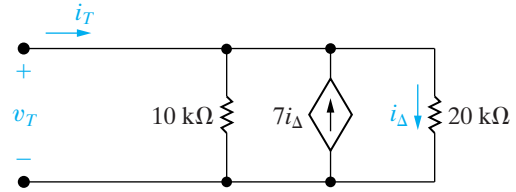
- a) To find the Thévenin equivalent resistance with respect to the capacitor terminals, we use the test-source method described in Chapter 4. Figure 7.38 shows the resulting circuit, where  $v_T$  is the test voltage and  $i_T$  is the test current. For  $v_T$  expressed in volts, we obtain

$$i_T = \frac{v_T}{10} - 7\left(\frac{v_T}{20}\right) + \frac{v_T}{20} \text{ mA.}$$

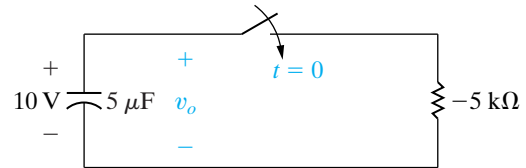
Solving for the ratio  $v_T/i_T$  yields the Thévenin resistance:

$$R_{Th} = \frac{v_T}{i_T} = -5 \text{ k}\Omega.$$

With this Thévenin resistance, we can simplify the circuit shown in Fig. 7.37 to the one shown in Fig. 7.39.



**Figure 7.38** ▲ The test-source method used to find  $R_{Th}$ .



**Figure 7.39** ▲ A simplification of the circuit shown in Fig. 7.37.

For  $t \geq 0$ , the differential equation describing the circuit shown in Fig. 7.39 is

$$(5 \times 10^{-6}) \frac{dv_o}{dt} - \frac{v_o}{5} \times 10^{-3} = 0.$$

Dividing by the coefficient of the first derivative yields

$$\frac{dv_o}{dt} - 40v_o = 0.$$

We now use the separation of variables technique to find  $v_o(t)$ :

$$v_o(t) = 10e^{40t} \text{ V}, \quad t \geq 0.$$

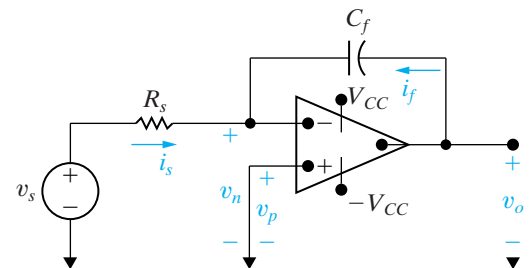
- b)  $v_o = 150 \text{ V}$  when  $e^{40t} = 15$ . Therefore,  $40t = \ln 15$ , and  $t = 67.70 \text{ ms}$ .

**NOTE:** Assess your understanding of this material by trying Chapter Problems 7.86 and 7.88.

The fact that interconnected circuit elements may lead to ever-increasing currents and voltages is important to engineers. If such interconnections are unintended, the resulting circuit may experience unexpected, and potentially dangerous, component failures.

## 7.7 The Integrating Amplifier

Recall from the introduction to Chapter 5 that one reason for our interest in the operational amplifier is its use as an integrating amplifier. We are now ready to analyze an integrating-amplifier circuit, which is shown in Fig. 7.40. The purpose of such a circuit is to generate an output voltage proportional to the integral of the input voltage. In Fig. 7.40, we added the branch currents  $i_f$  and  $i_s$ , along with the node voltages  $v_n$  and  $v_p$ , to aid our analysis.



**Figure 7.40** ▲ An integrating amplifier.

We assume that the operational amplifier is ideal. Thus we take advantage of the constraints

$$i_f + i_s = 0, \quad (7.61)$$

$$v_n = v_p. \quad (7.62)$$

Because  $v_p = 0$ ,

$$i_s = \frac{v_s}{R_s}, \quad (7.63)$$

$$i_f = C_f \frac{dv_o}{dt}. \quad (7.64)$$

Hence, from Eqs. 7.61, 7.63, and 7.64,

$$\frac{dv_o}{dt} = -\frac{1}{R_s C_f} v_s. \quad (7.65)$$

Multiplying both sides of Eq. 7.65 by a differential time  $dt$  and then integrating from  $t_0$  to  $t$  generates the equation

$$v_o(t) = -\frac{1}{R_s C_f} \int_{t_0}^t v_s dy + v_o(t_0). \quad (7.66)$$

In Eq. 7.66,  $t_0$  represents the instant in time when we begin the integration. Thus  $v_o(t_0)$  is the value of the output voltage at that time. Also, because  $v_n = v_p = 0$ ,  $v_o(t_0)$  is identical to the initial voltage on the feedback capacitor  $C_f$ .

Equation 7.66 states that the output voltage of an integrating amplifier equals the initial value of the voltage on the capacitor plus an inverted (minus sign), scaled ( $1/R_s C_f$ ) replica of the integral of the input voltage. If no energy is stored in the capacitor when integration commences, Eq. 7.66 reduces to

$$v_o(t) = -\frac{1}{R_s C_f} \int_{t_0}^t v_s dy. \quad (7.67)$$

If  $v_s$  is a step change in a dc voltage level, the output voltage will vary linearly with time. For example, assume that the input voltage is the rectangular voltage pulse shown in Fig. 7.41. Assume also that the initial value of  $v_o(t)$  is zero at the instant  $v_s$  steps from 0 to  $V_m$ . A direct application of Eq. 7.66 yields

$$v_o = -\frac{1}{R_s C_f} V_m t + 0, \quad 0 \leq t \leq t_1. \quad (7.68)$$

When  $t$  lies between  $t_1$  and  $2t_1$ ,

$$\begin{aligned} v_o &= -\frac{1}{R_s C_f} \int_{t_1}^t (-V_m) dy - \frac{1}{R_s C_f} V_m t_1 \\ &= \frac{V_m}{R_s C_f} t - \frac{2V_m}{R_s C_f} t_1, \quad t_1 \leq t \leq 2t_1. \end{aligned} \quad (7.69)$$

Figure 7.42 shows a sketch of  $v_o(t)$  versus  $t$ . Clearly, the output voltage is an inverted, scaled replica of the integral of the input voltage.

The output voltage is proportional to the integral of the input voltage only if the op amp operates within its linear range, that is, if it doesn't saturate. Examples 7.14 and 7.15 further illustrate the analysis of the integrating amplifier.

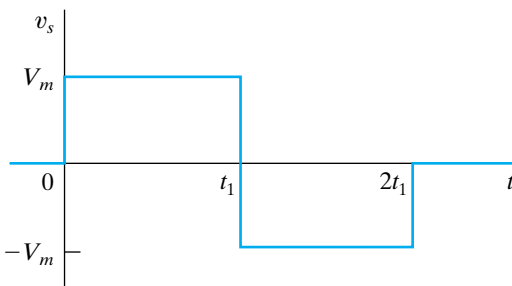


Figure 7.41 ▲ An input voltage signal.

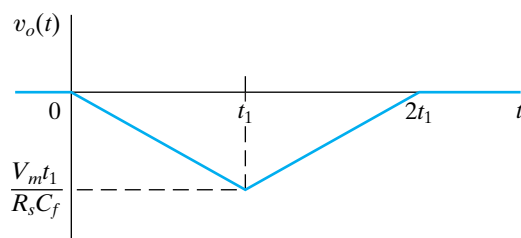


Figure 7.42 ▲ The output voltage of an integrating amplifier.

**Example 7.14** Analyzing an Integrating Amplifier

Assume that the numerical values for the signal voltage shown in Fig. 7.41 are  $V_m = 50$  mV and  $t_1 = 1$  s. This signal voltage is applied to the integrating-amplifier circuit shown in Fig. 7.40. The circuit parameters of the amplifier are  $R_s = 100$  k $\Omega$ ,  $C_f = 0.1$   $\mu$ F, and  $V_{CC} = 6$  V. The initial voltage on the capacitor is zero.

- a) Calculate  $v_o(t)$ .  
b) Plot  $v_o(t)$  versus  $t$ .

**Solution**

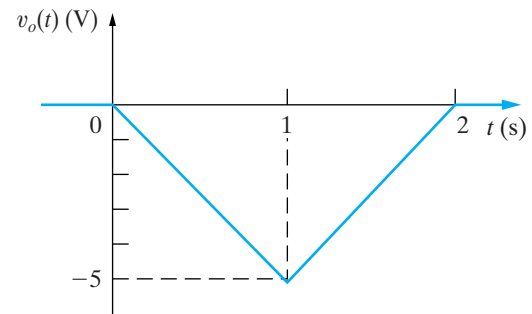
- a) For  $0 \leq t \leq 1$  s,

$$\begin{aligned} v_o &= \frac{-1}{(100 \times 10^3)(0.1 \times 10^{-6})} 50 \times 10^{-3} t + 0 \\ &= -5t \text{ V}, \quad 0 \leq t \leq 1 \text{ s.} \end{aligned}$$

For  $1 \leq t \leq 2$  s,

$$v_o = (5t - 10) \text{ V.}$$

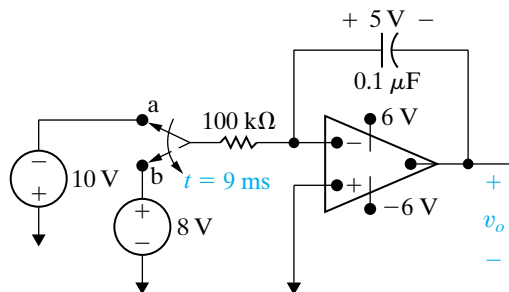
- b) Figure 7.43 shows a plot of  $v_o(t)$  versus  $t$ .



**Figure 7.43** ▲ The output voltage for Example 7.14.

**Example 7.15** Analyzing an Integrating Amplifier that has Sequential Switching

At the instant the switch makes contact with terminal a in the circuit shown in Fig. 7.44, the voltage on the  $0.1$   $\mu$ F capacitor is  $5$  V. The switch remains at terminal a for  $9$  ms and then moves instantaneously to terminal b. How many milliseconds after making contact with terminal b does the operational amplifier saturate?



**Figure 7.44** ▲ The circuit for Example 7.15.

**Solution**

The expression for the output voltage during the time the switch is at terminal a is

$$\begin{aligned} v_o &= -5 - \frac{1}{10^{-2}} \int_0^t (-10) dy \\ &= (-5 + 1000t) \text{ V.} \end{aligned}$$

Thus,  $9$  ms after the switch makes contact with terminal a, the output voltage is  $-5 + 9$ , or  $4$  V.

The expression for the output voltage after the switch moves to terminal b is

$$\begin{aligned} v_o &= 4 - \frac{1}{10^{-2}} \int_{9 \times 10^{-3}}^t 8 dy \\ &= 4 - 800(t - 9 \times 10^{-3}) \\ &= (11.2 - 800t) \text{ V.} \end{aligned}$$

During this time interval, the voltage is decreasing, and the operational amplifier eventually saturates at  $-6$  V. Therefore we set the expression for  $v_o$  equal to  $-6$  V to obtain the saturation time  $t_s$ :

$$11.2 - 800t_s = -6,$$

or

$$t_s = 21.5 \text{ ms.}$$

Thus the integrating amplifier saturates  $21.5$  ms after making contact with terminal b.

From the examples, we see that the integrating amplifier can perform the integration function very well, but only within specified limits that avoid saturating the op amp. The op amp saturates due to the accumulation of charge on the feedback capacitor. We can prevent it from saturating by placing a resistor in parallel with the feedback capacitor. We examine such a circuit in Chapter 8.

Note that we can convert the integrating amplifier to a differentiating amplifier by interchanging the input resistance  $R_s$  and the feedback capacitor  $C_f$ . Then

$$v_o = -R_s C_f \frac{dv_s}{dt}. \quad (7.70)$$

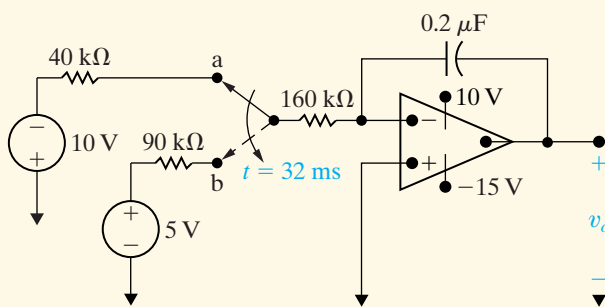
We leave the derivation of Eq. 7.70 as an exercise for you. The differentiating amplifier is seldom used because in practice it is a source of unwanted or noisy signals.

Finally, we can design both integrating- and differentiating-amplifier circuits by using an inductor instead of a capacitor. However, fabricating capacitors for integrated-circuit devices is much easier, so inductors are rarely used in integrating amplifiers.

## ASSESSMENT PROBLEMS

**Objective 4—Be able to analyze op amp circuits containing resistors and a single capacitor**

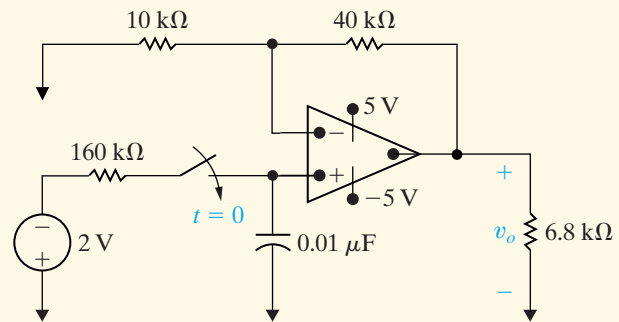
- 7.9** There is no energy stored in the capacitor at the time the switch in the circuit makes contact with terminal a. The switch remains at position a for 32 ms and then moves instantaneously to position b. How many milliseconds after making contact with terminal a does the op amp saturate?



**Answer:** 262 ms.

*NOTE: Also try Chapter Problems 7.94 and 7.95.*

- 7.10** a) When the switch closes in the circuit shown, there is no energy stored in the capacitor. How long does it take to saturate the op amp?  
b) Repeat (a) with an initial voltage on the capacitor of 1 V, positive at the upper terminal.



**Answer:** (a) 1.11 ms;  
(b) 1.76 ms.

## Practical Perspective

### Artificial Pacemaker

We are now ready to analyze a simple RC circuit, shown in Fig. 7.45, which can generate periodic electrical impulses. This RC circuit can be used in an artificial pacemaker to establish a normal heart rhythm. The box labeled “controller” behaves as an open circuit until the voltage drop across the capacitor reaches a pre-set limit. Once that limit is reached, the capacitor discharges its stored energy in the form of an electrical impulse to the heart and starts to recharge and the process repeats.

Before we develop the analytical expressions that describe the behavior of the circuit, let us develop a feel for how that circuit works. First, when the controller behaves as an open circuit, the dc voltage source will charge the capacitor via the resistor  $R$ , toward a value of  $V_s$  volts. But once the capacitor voltage reaches  $V_{\max}$ , the controller behaves like a short circuit, enabling the capacitor to discharge. Once the capacitor discharge is complete, the controller once again acts as an open circuit and the capacitor starts to recharge. This cycle of charging and discharging the capacitor establishes the desired heart rhythm, as shown in Fig. 7.46.

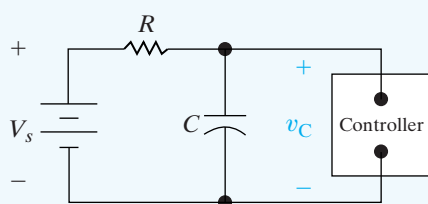


Figure 7.45 ▲ An artificial pacemaker circuit.

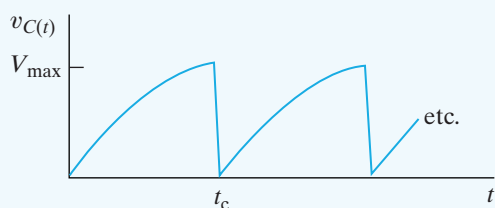


Figure 7.46 ▲ Capacitor voltage versus time for the circuit in Fig. 7.45.

In drawing Fig. 7.46 we have chosen  $t = 0$  at the instant the capacitor starts to charge. This figure also assumes that the circuit has reached the repetitive stage of its operation, and that the time to discharge the capacitor is negligible when compared to the recharge time. The design of this artificial pacemaker circuit requires an equation for  $v_C(t)$  as a function of  $V_{\max}$ ,  $R$ , and  $C$ .

To begin the analysis, we assume that the circuit has been in operation for a long time. Let  $t = 0$  at the instant when the capacitor has completely discharged and the controller is acting as an open circuit. From the circuit we find

$$\begin{aligned} v_C(\infty) &= V_s, \\ v_C(0) &= 0, \\ \tau &= RC. \end{aligned}$$

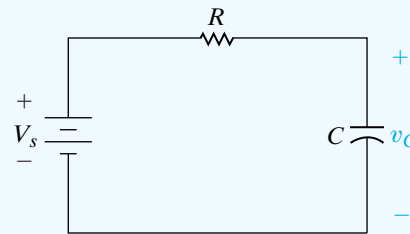
Thus, while the capacitor is charging,

$$v_C(t) = V_s(1 - e^{-t/RC}).$$

Suppose the controller has been programmed to fire an electrical pulse to stimulate the heart when  $v_C = 0.75V_s$ . Given values of  $R$  and  $C$  we can determine the resulting heart rate in beats per minute as follows:

$$H = \frac{60}{-RC \ln 0.25} \text{ [beats per minute]}$$

A more realistic design problem requires you to calculate the value of resistance,  $R$ , given  $V_{\max}$  as a percentage of  $V_s$ ,  $C$ , and the desired heart rate in beats per minute. We leave you to develop an equation for resistance in Problem 7.106.



**Figure 7.47** ▲ The artificial pacemaker circuit at  $t = 0$ , when the capacitor is charging.

*NOTE:* Assess your understanding of the Practical Perspective by solving Chapter Problems 7.104–7.107.

## Summary

- A first-order circuit may be reduced to a Thévenin (or Norton) equivalent connected to either a single equivalent inductor or capacitor. (See page 214.)
- The **natural response** is the currents and voltages that exist when stored energy is released to a circuit that contains no independent sources. (See page 212.)
- The **time constant** of an  $RL$  circuit equals the equivalent inductance divided by the Thévenin resistance as viewed from the terminals of the equivalent inductor. (See page 216.)
- The **time constant** of an  $RC$  circuit equals the equivalent capacitance times the Thévenin resistance as viewed from the terminals of the equivalent capacitor. (See page 221.)
- The **step response** is the currents and voltages that result from abrupt changes in dc sources connected to a circuit. Stored energy may or may not be present at the time the abrupt changes take place. (See page 224.)
- The solution for either the natural or step response of both  $RL$  and  $RC$  circuits involves finding the initial and final value of the current or voltage of interest and the time constant of the circuit. Equations 7.59 and 7.60 summarize this approach. (See page 232.)
- **Sequential switching** in first-order circuits is analyzed by dividing the analysis into time intervals corresponding to specific switch positions. Initial values for a particular interval are determined from the solution corresponding to the immediately preceding interval. (See page 236.)
- An **unbounded response** occurs when the Thévenin resistance is negative, which is possible when the first-order circuit contains dependent sources. (See page 240.)
- An integrating amplifier consists of an ideal op amp, a capacitor in the negative feedback branch, and a resistor in series with the signal source. It outputs the integral of the signal source, within specified limits that avoid saturating the op amp. (See page 241.)



## Problems

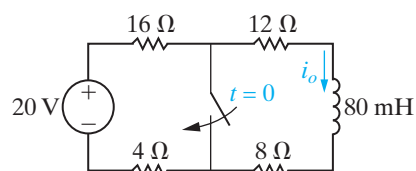
### Section 7.1

**7.1** The switch in the circuit in Fig. P7.1 has been open for a long time. At  $t = 0$  the switch is closed.

PSPICE  
MULTISIM

- Determine  $i_o(0)$  and  $i_o(\infty)$ .
- Determine  $i_o(t)$  for  $t \geq 0$ .
- How many milliseconds after the switch has been closed will  $i_o$  equal 100 mA?

Figure P7.1

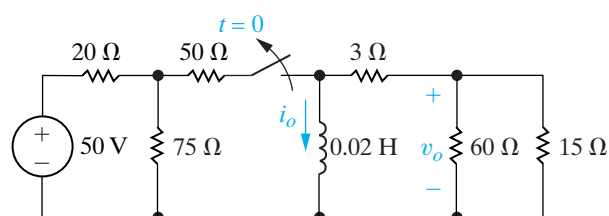


**7.2** The switch in the circuit in Fig. P7.2 has been closed for a long time. At  $t = 0$  it is opened.

PSPICE  
MULTISIM

- Write the expression for  $i_o(t)$  for  $t \geq 0$ .
- Write the expression for  $v_o(t)$  for  $t \geq 0^+$ .

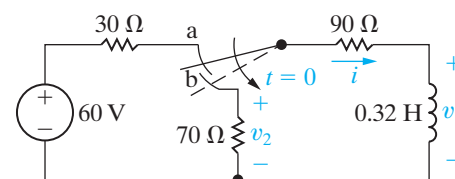
Figure P7.2



**7.3** In the circuit shown in Fig. P7.3, the switch makes contact with position b just before breaking contact with position a. As already mentioned, this is known as a make-before-break switch and is designed so that the switch does not interrupt the current in an inductive circuit. The interval of time between “making” and “breaking” is assumed to be negligible. The switch has been in the a position for a long time. At  $t = 0$  the switch is thrown from position a to position b.

- Determine the initial current in the inductor.
- Determine the time constant of the circuit for  $t > 0$ .
- Find  $i$ ,  $v_1$ , and  $v_2$  for  $t \geq 0$ .
- What percentage of the initial energy stored in the inductor is dissipated in the 90 Ω resistor 1 ms after the switch is thrown from position a to position b?

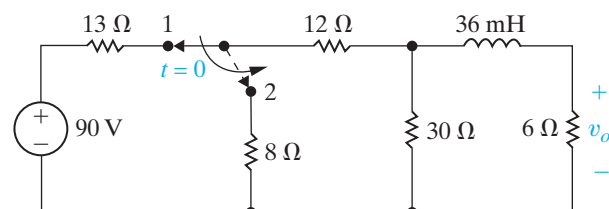
Figure P7.3



**7.4** The switch in the circuit in Fig. P7.4 has been in position 1 for a long time. At  $t = 0$ , the switch moves instantaneously to position 2. Find  $v_o(t)$  for  $t \geq 0^+$ .

PSPICE  
MULTISIM

Figure P7.4

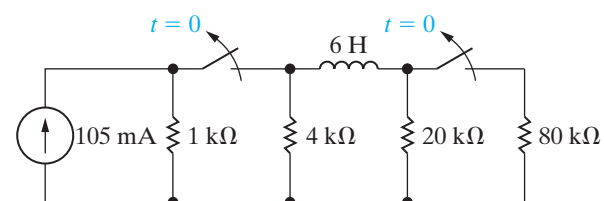


**7.5** For the circuit of Fig. P7.4, what percentage of the initial energy stored in the inductor is eventually dissipated in the 6 Ω resistor?

**7.6** The two switches in the circuit seen in Fig. P7.6 are synchronized. The switches have been closed for a long time before opening at  $t = 0$ .

- How many microseconds after the switches are open is the energy dissipated in the 4 kΩ resistor 10% of the initial energy stored in the 6 H inductor?
- At the time calculated in (a), what percentage of the total energy stored in the inductor has been dissipated?

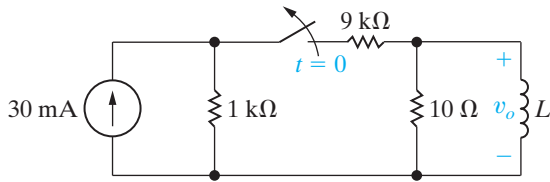
Figure P7.6



**7.7** In the circuit in Fig. P7.7, the switch has been closed for a long time before opening at  $t = 0$ .

- Find the value of  $L$  so that  $v_o(t)$  equals  $0.5 v_o(0^+)$  when  $t = 1$  ms.
- Find the percentage of the stored energy that has been dissipated in the 10 Ω resistor when  $t = 1$  ms.

Figure P7.7

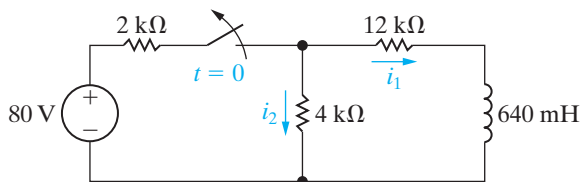


**7.8** The switch in the circuit in Fig. P7.8 has been closed for a long time before opening at  $t = 0$ .

**PSPICE**  
**MULTISIM**

- Find  $i_1(0^-)$  and  $i_2(0^-)$ .
- Find  $i_1(0^+)$  and  $i_2(0^+)$ .
- Find  $i_1(t)$  for  $t \geq 0$ .
- Find  $i_2(t)$  for  $t \geq 0^+$ .
- Explain why  $i_2(0^-) \neq i_2(0^+)$ .

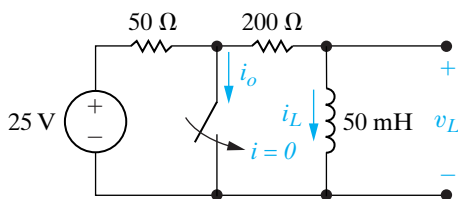
Figure P7.8



**7.9** The switch shown in Fig. P7.9 has been open for a long time before closing at  $t = 0$ .

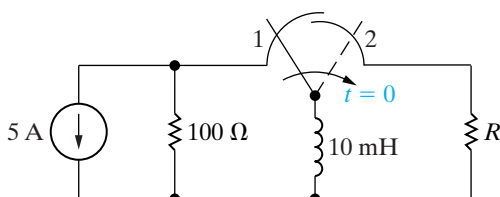
- Find  $i_o(0^-)$ ,  $i_L(0^-)$ , and  $v_L(0^-)$ .
- Find  $i_o(0^+)$ ,  $i_L(0^+)$ , and  $v_L(0^+)$ .
- Find  $i_o(\infty)$ ,  $i_L(\infty)$ , and  $v_L(\infty)$ .
- Write the expression for  $i_L(t)$  for  $t \geq 0$ .
- Write the expression for  $i_o(t)$  for  $t \geq 0^+$ .
- Write the expression for  $v_L(t)$  for  $t \geq 0^+$ .

Figure P7.9



**7.10** The switch in the circuit seen in Fig. P7.10 has been in position 1 for a long time. At  $t = 0$ , the switch moves instantaneously to position 2. Find the value of  $R$  so that 10% of the initial energy stored in the 10 mH inductor is dissipated in  $R$  in  $10 \mu\text{s}$ .

Figure P7.10



**7.11** In the circuit in Fig. P7.10, let  $I_g$  represent the dc current source,  $\sigma$  represent the fraction of initial energy stored in the inductor that is dissipated in  $t_o$  seconds, and  $L$  represent the inductance.

- Show that

$$R = \frac{L \ln [1/(1 - \sigma)]}{2t_o}$$

- Test the expression derived in (a) by using it to find the value of  $R$  in Problem 7.10.

**7.12** In the circuit in Fig. P7.12, the voltage and current expressions are

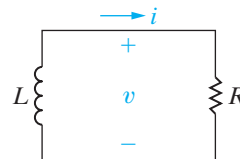
$$v = 160e^{-10t} \text{ V}, \quad t \geq 0^+;$$

$$i = 6.4e^{-10t} \text{ A}, \quad t \geq 0.$$

Find

- $R$ .
- $\tau$  (in milliseconds).
- $L$ .
- the initial energy stored in the inductor.
- the time (in milliseconds) it takes to dissipate 60% of the initial stored energy.

Figure P7.12



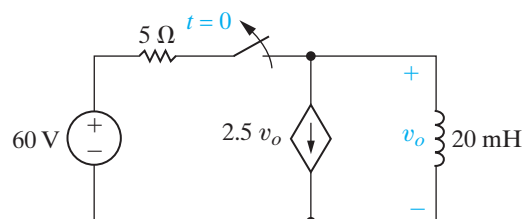
**7.13** a) Use component values from Appendix H to create a first-order  $RL$  circuit (see Fig. 7.4) with a time constant of 1 ms. Use a single inductor and a network of resistors, if necessary. Draw your circuit.

- Suppose the inductor you chose in part (a) has an initial current of 10 mA. Write an expression for the current through the inductor for  $t \geq 0$ .
- Using your result from part (b), calculate the time at which half of the initial energy stored in the inductor has been dissipated by the resistor.

**7.14** The switch in the circuit in Fig. P7.14 has been closed for a long time before opening at  $t = 0$ . Find  $v_o(t)$  for  $t \geq 0^+$ .

**PSPICE**  
**MULTISIM**

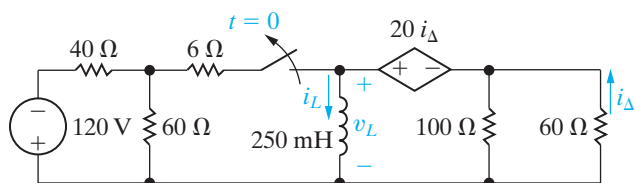
Figure P7.14



**7.15** The switch in Fig. P7.15 has been closed for a long time before opening at  $t = 0$ . Find

- $i_L(t)$ ,  $t \geq 0$ .
- $v_L(t)$ ,  $t \geq 0^+$ .
- $i_{\Delta}(t)$ ,  $t \geq 0^+$ .

Figure P7.15



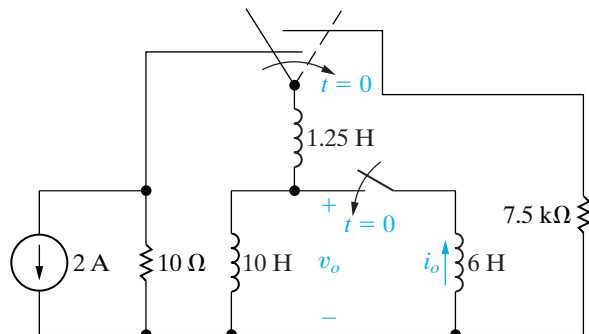
**7.16** What percentage of the initial energy stored in the inductor in the circuit in Fig. P7.15 is dissipated by the  $60 \Omega$  resistor?

**7.17** The two switches shown in the circuit in Fig. P7.17 operate simultaneously. Prior to  $t = 0$  each switch has been in its indicated position for a long time. At  $t = 0$  the two switches move instantaneously to their new positions. Find

PSPICE  
MULTISIM

- $v_o(t)$ ,  $t \geq 0^+$ .
- $i_o(t)$ ,  $t \geq 0$ .

Figure P7.17



**7.18** For the circuit seen in Fig. P7.17, find

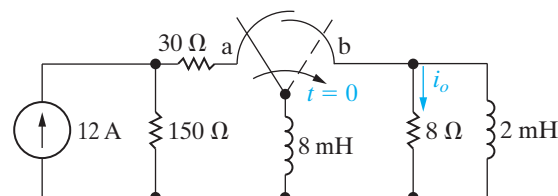
- the total energy dissipated in the  $7.5 \text{ k}\Omega$  resistor.
- the energy trapped in the ideal inductors.

**7.19** In the circuit shown in Fig. P7.19, the switch has been in position a for a long time. At  $t = 0$ , it moves instantaneously from a to b.

PSPICE  
MULTISIM

- Find  $i_o(t)$  for  $t \geq 0$ .
- What is the total energy delivered to the  $8 \Omega$  resistor?
- How many time constants does it take to deliver 95% of the energy found in (b)?

Figure P7.19

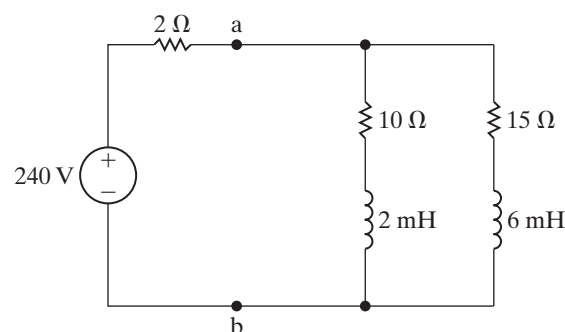


**7.20** The  $240 \text{ V}$ ,  $2 \Omega$  source in the circuit in Fig. P7.20 is inadvertently short-circuited at its terminals a, b. At the time the fault occurs, the circuit has been in operation for a long time.

PSPICE  
MULTISIM

- What is the initial value of the current  $i_{ab}$  in the short-circuit connection between terminals a, b?
- What is the final value of the current  $i_{ab}$ ?
- How many microseconds after the short circuit has occurred is the current in the short equal to  $114 \text{ A}$ ?

Figure P7.20

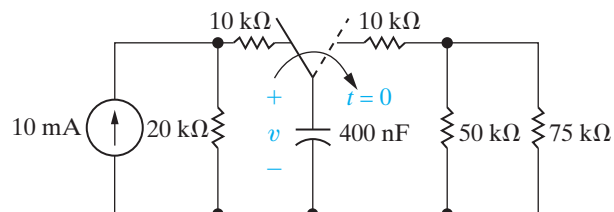


## Section 7.2

**7.21** The switch in the circuit in Fig. P7.21 has been in the left position for a long time. At  $t = 0$  it moves to the right position and stays there.

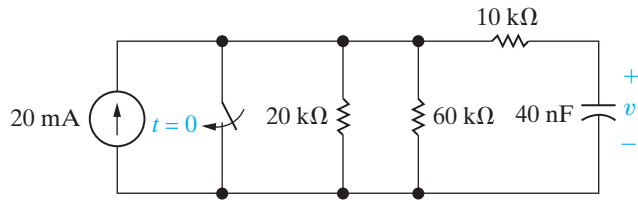
- Find the initial voltage drop across the capacitor.
- Find the initial energy stored by the capacitor.
- Find the time constant of this circuit for  $t > 0$ .
- Write the expression for the capacitor voltage  $v(t)$  for  $t \geq 0$ .

Figure P7.21



- 7.22** The switch shown in Fig. P7.22 has been open for a long time before closing at  $t = 0$ . Write the expression for the capacitor voltage,  $v(t)$ , for  $t \geq 0$ .

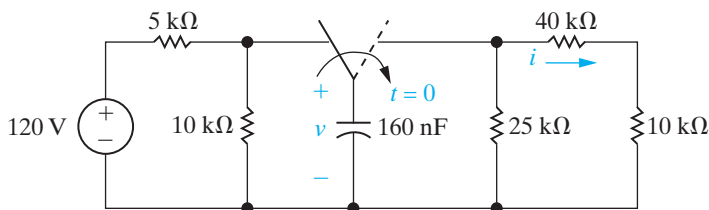
Figure P7.22



- 7.23** The switch in the circuit in Fig. P7.23 has been in the left position for a long time. At  $t = 0$  it moves to the right position and stays there.

- Write the expression for the capacitor voltage,  $v(t)$ , for  $t \geq 0$ .
- Write the expression for the current through the  $40\text{ k}\Omega$  resistor,  $i(t)$ , for  $t \geq 0^+$ .

Figure P7.23

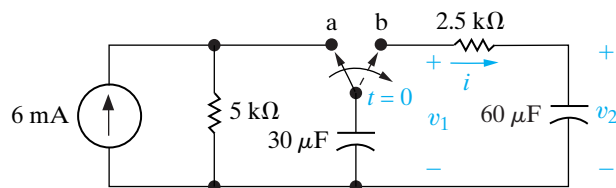


- 7.24** What percentage of the initial energy stored in the capacitor in Fig. P7.23 is dissipated by the  $40\text{ k}\Omega$  resistor?

- 7.25** The switch in the circuit in Fig. P7.25 has been in position a for a long time and  $v_2 = 0\text{ V}$ . At  $t = 0$ , the switch is thrown to position b. Calculate

- $i$ ,  $v_1$ , and  $v_2$  for  $t \geq 0^+$ ,
- the energy stored in the  $30\text{ }\mu\text{F}$  capacitor at  $t = 0$ , and
- the energy trapped in the circuit and the total energy dissipated in the  $2.5\text{ k}\Omega$  resistor if the switch remains in position b indefinitely.

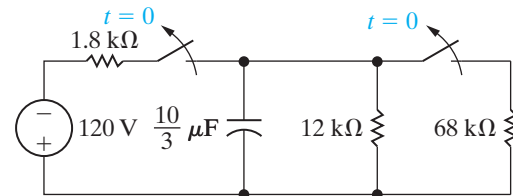
Figure P7.25



- 7.26** In the circuit shown in Fig. P7.26, both switches operate together; that is, they either open or close at the same time. The switches are closed a long time before opening at  $t = 0$ .

- How many microjoules of energy have been dissipated in the  $12\text{ k}\Omega$  resistor 12 ms after the switches open?
- How long does it take to dissipate 75% of the initially stored energy?

Figure P7.26

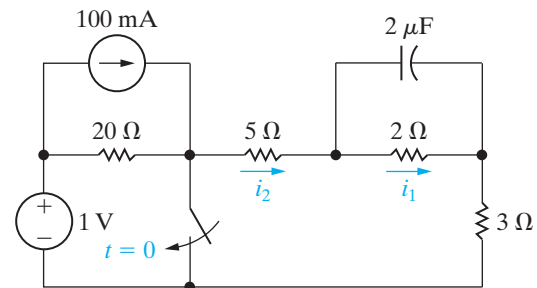


- 7.27** The switch in the circuit in Fig. P7.27 is closed at  $t = 0$  after being open for a long time.

PSPICE  
MULTISIM

- Find  $i_1(0^-)$  and  $i_2(0^-)$ .
- Find  $i_1(0^+)$  and  $i_2(0^+)$ .
- Explain why  $i_1(0^-) = i_1(0^+)$ .
- Explain why  $i_2(0^-) \neq i_2(0^+)$ .
- Find  $i_1(t)$  for  $t \geq 0$ .
- Find  $i_2(t)$  for  $t \geq 0^+$ .

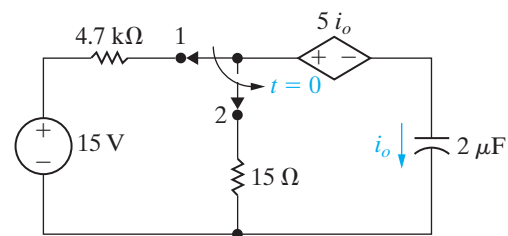
Figure P7.27



- 7.28** The switch in the circuit in Fig. P7.28 has been in position 1 for a long time before moving to position 2 at  $t = 0$ . Find  $i_o(t)$  for  $t \geq 0^+$ .

PSPICE  
MULTISIM

Figure P7.28



- 7.29** In the circuit in Fig. P7.29 the voltage and current expressions are

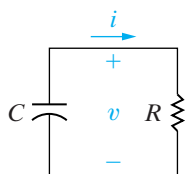
$$v = 72e^{-500t} \text{ V}, \quad t \geq 0;$$

$$i = 9e^{-500t} \text{ mA}, \quad t \geq 0^+.$$

Find

- $R$ .
- $C$ .
- $\tau$  (in milliseconds).
- the initial energy stored in the capacitor.
- how many microseconds it takes to dissipate 68% of the initial energy stored in the capacitor.

Figure P7.29

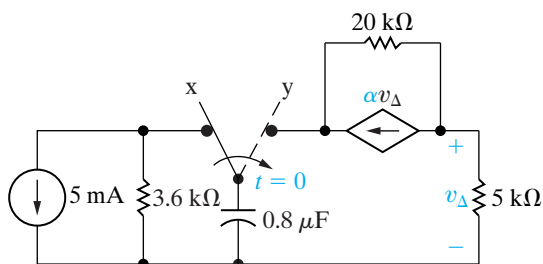


- 7.30** a) Use component values from Appendix H to create a first-order RC circuit (see Fig. 7.11) with a time constant of 50 ms. Use a single capacitor and a network of resistors, if necessary. Draw your circuit.
- b) Suppose the capacitor you chose in part (a) has an initial voltage drop of 50 V. Write an expression for the voltage drop across the capacitor for  $t \geq 0$ .
- c) Using your result from part (b), calculate the time at which the voltage drop across the capacitor has reached 10 V.

- 7.31** The switch in the circuit seen in Fig. P7.31 has been in position x for a long time. At  $t = 0$ , the switch moves instantaneously to position y.

- Find  $\alpha$  so that the time constant for  $t > 0$  is 40 ms.
- For the  $\alpha$  found in (a), find  $v_{\Delta}$ .

Figure P7.31



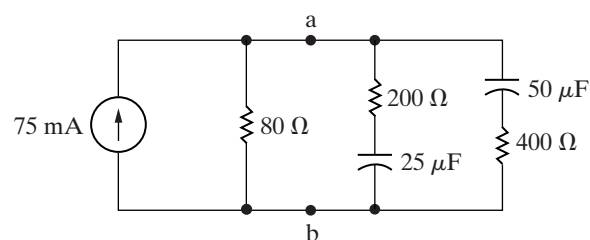
- 7.32** a) In Problem 7.31, how many microjoules of energy are generated by the dependent current source during the time the capacitor discharges to 0 V?

- b) Show that for  $t \geq 0$  the total energy stored and generated in the capacitive circuit equals the total energy dissipated.

- 7.33** After the circuit in Fig. P7.33 has been in operation for a long time, a screwdriver is inadvertently connected across the terminals a, b. Assume the resistance of the screwdriver is negligible.

- Find the current in the screwdriver at  $t = 0^+$  and  $t = \infty$ .
- Derive the expression for the current in the screwdriver for  $t \geq 0^+$ .

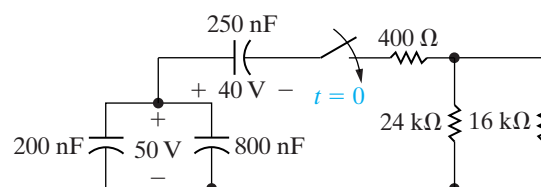
Figure P7.33



- 7.34** At the time the switch is closed in the circuit in Fig. P7.34, the voltage across the parallel capacitors is 50 V and the voltage on the 250 nF capacitor is 40 V.

- What percentage of the initial energy stored in the three capacitors is dissipated in the 24 kΩ resistor?
- Repeat (a) for the 400 Ω and 16 kΩ resistors.
- What percentage of the initial energy is trapped in the capacitors?

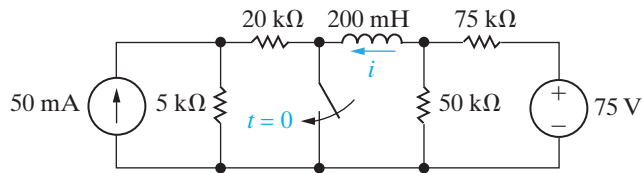
Figure P7.34



### Section 7.3

- 7.35** After the switch in the circuit of Fig. P7.35 has been open for a long time, it is closed at  $t = 0$ . Calculate (a) the initial value of  $i$ ; (b) the final value of  $i$ ; (c) the time constant for  $t \geq 0$ ; and (d) the numerical expression for  $i(t)$  when  $t \geq 0$ .

Figure P7.35

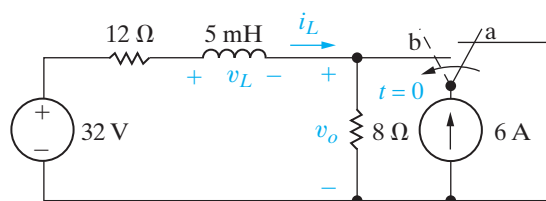


**7.36** The switch in the circuit shown in Fig. P7.36 has been in position a for a long time before moving to position b at  $t = 0$ .

PSPICE  
MULTISIM

- Find the numerical expressions for  $i_L(t)$  and  $v_o(t)$  for  $t \geq 0$ .
- Find the numerical values of  $v_L(0^+)$  and  $v_o(0^+)$ .

Figure P7.36

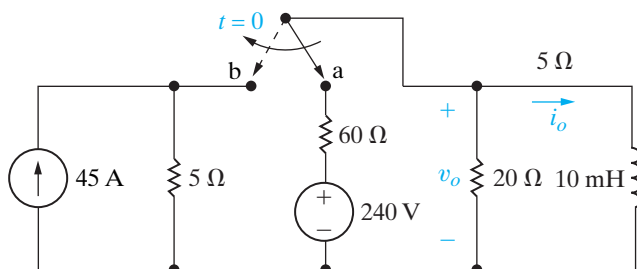


**7.37** The switch in the circuit shown in Fig. P7.37 has been in position a for a long time. At  $t = 0$ , the switch moves instantaneously to position b.

PSPICE  
MULTISIM

- Find the numerical expression for  $i_o(t)$  when  $t \geq 0$ .
- Find the numerical expression for  $v_o(t)$  for  $t \geq 0^+$ .

Figure P7.37



**7.38** Repeat Problem 7.37 assuming that the switch in the circuit in Fig. P7.37 has been in position b for a long time and then moves to position a at  $t = 0$  and stays there.

**7.39** The current and voltage at the terminals of the inductor in the circuit in Fig. 7.16 are

$$i(t) = (4 + 4e^{-40t}) \text{ A}, \quad t \geq 0;$$

$$v(t) = -80e^{-40t} \text{ V}, \quad t \geq 0^+.$$

- Specify the numerical values of  $V_s$ ,  $R$ ,  $I_o$ , and  $L$ .
- How many milliseconds after the switch has been closed does the energy stored in the inductor reach 9 J?

**7.40** a) Use component values from Appendix H to create a first-order  $RL$  circuit (see Fig. 7.16) with a time constant of  $8 \mu\text{s}$ . Use a single inductor and a network of resistors, if necessary. Draw your circuit.

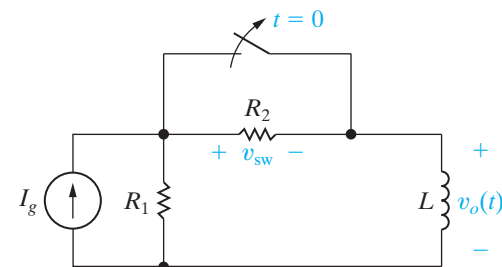
b) Suppose the inductor you chose in part (a) has no initial stored energy. At  $t = 0$ , a switch connects a voltage source with a value of 25 V in series with the inductor and equivalent resistance. Write an expression for the current through the inductor for  $t \geq 0$ .

c) Using your result from part (b), calculate the time at which the current through the inductor reaches 75% of its final value.

**7.41** The switch in the circuit shown in Fig. P7.41 has been closed for a long time. The switch opens at  $t = 0$ . For  $t \geq 0^+$ :

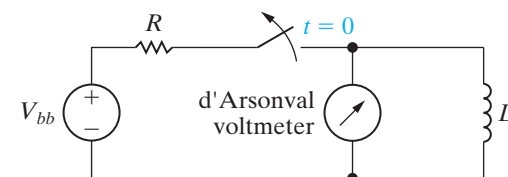
- Find  $v_o(t)$  as a function of  $I_g$ ,  $R_1$ ,  $R_2$ , and  $L$ .
- Explain what happens to  $v_o(t)$  as  $R_2$  gets larger and larger.
- Find  $v_{\text{sw}}$  as a function of  $I_g$ ,  $R_1$ ,  $R_2$ , and  $L$ .
- Explain what happens to  $v_{\text{sw}}$  as  $R_2$  gets larger and larger.

Figure P7.41



**7.42** The switch in the circuit in Fig. P7.42 has been closed for a long time. A student abruptly opens the switch and reports to her instructor that when the switch opened, an electric arc with noticeable persistence was established across the switch, and at the same time the voltmeter placed across the coil was damaged. On the basis of your analysis of the circuit in Problem 7.41, can you explain to the student why this happened?

Figure P7.42



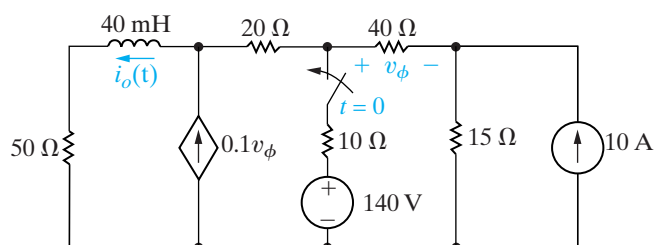
**7.43** a) Derive Eq. 7.47 by first converting the Thévenin equivalent in Fig. 7.16 to a Norton equivalent

and then summing the currents away from the upper node, using the inductor voltage  $v$  as the variable of interest.

- b) Use the separation of variables technique to find the solution to Eq. 7.47. Verify that your solution agrees with the solution given in Eq. 7.42.

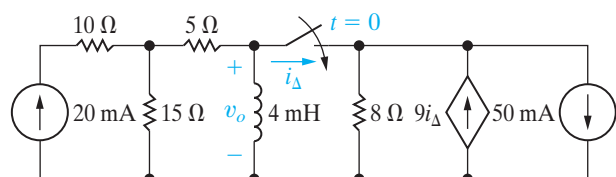
**7.44** The switch in the circuit in Fig. P7.44 has been open a long time before closing at  $t = 0$ . Find  $i_o(t)$  for  $t \geq 0$ .

Figure P7.44



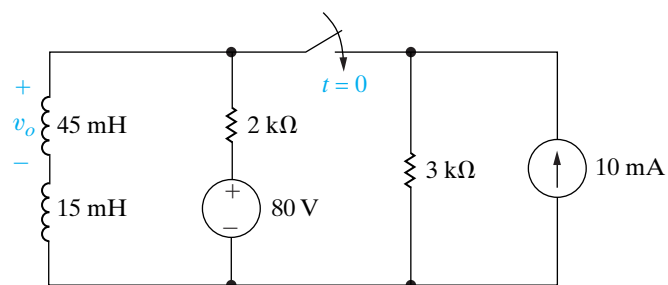
**7.45** The switch in the circuit in Fig. P7.45 has been open a long time before closing at  $t = 0$ . Find  $v_o(t)$  for  $t \geq 0^+$ .

Figure P7.45



**7.46** The switch in the circuit in Fig. P7.46 has been open a long time before closing at  $t = 0$ . Find  $v_o(t)$  for  $t \geq 0^+$ .

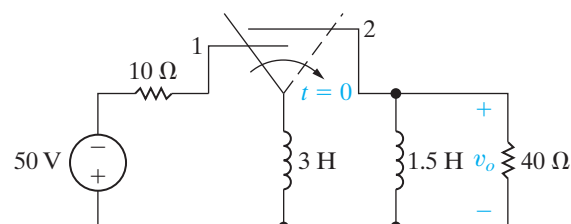
Figure P7.46



**7.47** The switch in the circuit in Fig. P7.47 has been in position 1 for a long time. At  $t = 0$  it moves instantaneously to position 2. How many milliseconds after the switch operates does  $v_o$  equal 100 V?

PSPICE  
MULTISIM

Figure P7.47



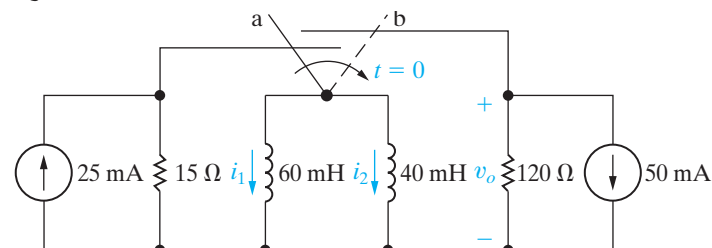
**7.48** For the circuit in Fig. P7.47, find (in joules):  
a) the total energy dissipated in the 40 Ω resistor;  
b) the energy trapped in the inductors, and  
c) the initial energy stored in the inductors.

**7.49** The make-before-break switch in the circuit of Fig. P7.49 has been in position a for a long time. At  $t = 0$ , the switch moves instantaneously to position b. Find

PSPICE  
MULTISIM

- a)  $v_o(t)$ ,  $t \geq 0^+$ .  
b)  $i_1(t)$ ,  $t \geq 0$ .  
c)  $i_2(t)$ ,  $t \geq 0$ .

Figure P7.49

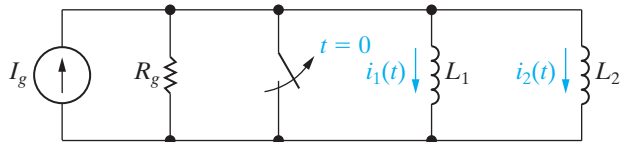


**7.50** There is no energy stored in the inductors  $L_1$  and  $L_2$  at the time the switch is opened in the circuit shown in Fig. P7.50.

- a) Derive the expressions for the currents  $i_1(t)$  and  $i_2(t)$  for  $t \geq 0$ .  
b) Use the expressions derived in (a) to find  $i_1(\infty)$  and  $i_2(\infty)$ .

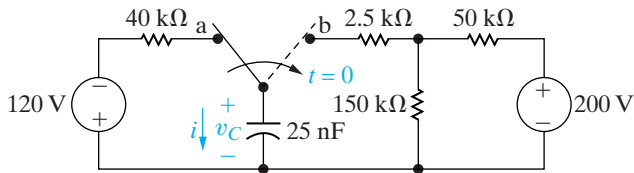


Figure P7.50



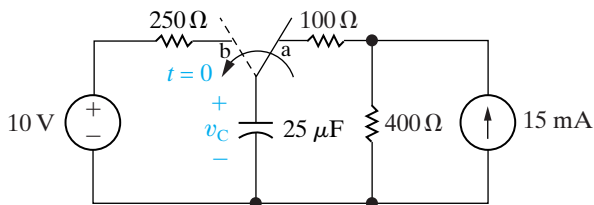
7.51 Assume that the switch in the circuit of Fig. P7.51 has been in position a for a long time and that at  $t = 0$  it is moved to position b. Find (a)  $v_C(0^+)$ ; (b)  $v_C(\infty)$ ; (c)  $\tau$  for  $t > 0$ ; (d)  $i(0^+)$ ; (e)  $v_C, t \geq 0$ ; and (f)  $i, t \geq 0^+$ .

Figure P7.51



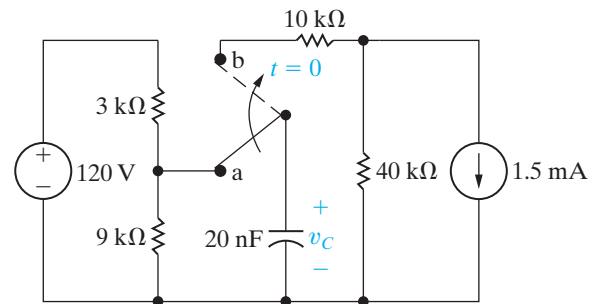
7.52 a) The switch in the circuit in Fig. P7.52 has been in position a for a long time. At  $t = 0$ , the switch moves instantaneously to position b and stays there. Find the initial and final values of the capacitor voltage, the time constant for  $t \geq 0$ , and the expression for the capacitor voltage for  $t \geq 0$ .  
 b) Now suppose the switch in the circuit in Fig. P7.52 has been in position b for a long time. At  $t = 0$ , the switch moves instantaneously to position a and stays there. Find the initial and final values of the capacitor voltage, the time constant for  $t \geq 0$ , and the expression for the capacitor voltage for  $t \geq 0$ .

Figure P7.52



7.53 The switch in the circuit of Fig. P7.53 has been in position a for a long time. At  $t = 0$  the switch is moved to position b. Calculate (a) the initial voltage on the capacitor; (b) the final voltage on the capacitor; (c) the time constant (in microseconds) for  $t > 0$ ; and (d) the length of time (in microseconds) required for the capacitor voltage to reach zero after the switch is moved to position b.

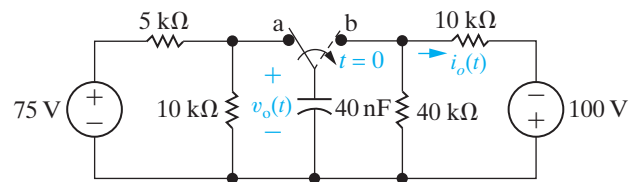
Figure P7.53



7.54 The switch in the circuit seen in Fig. P7.54 has been in position a for a long time. At  $t = 0$ , the switch moves instantaneously to position b. For  $t \geq 0^+$ , find

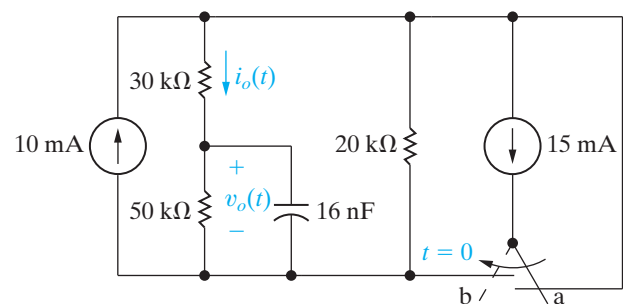
- a)  $v_o(t)$ .
- b)  $i_o(t)$ .

Figure P7.54



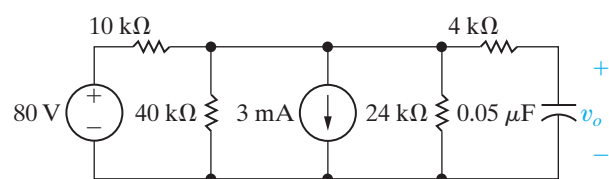
7.55 The switch in the circuit seen in Fig. P7.55 has been in position a for a long time. At  $t = 0$ , the switch moves instantaneously to position b. Find  $v_o(t)$  and  $i_o(t)$  for  $t \geq 0^+$ .

Figure P7.55



7.56 The circuit in Fig. P7.56 has been in operation for a long time. At  $t = 0$ , the voltage source reverses polarity and the current source drops from 3 mA to 2 mA. Find  $v_o(t)$  for  $t \geq 0$ .

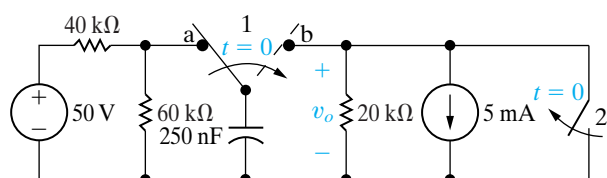
Figure P7.56



**7.57** The switch in the circuit in Fig. P7.57 has been in position a for a long time. At  $t = 0$ , the switch moves instantaneously to position b. At the instant the switch makes contact with terminal b, switch 2 opens. Find  $v_o(t)$  for  $t \geq 0$ .

PSPICE  
MULTISIM

Figure P7.57



**7.58** The current and voltage at the terminals of the capacitor in the circuit in Fig. 7.21 are

$$i(t) = 3e^{-2500t} \text{ mA}, \quad t \geq 0^+;$$

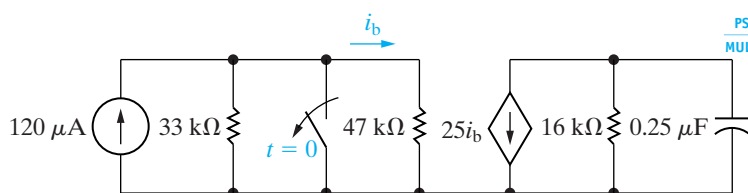
$$v(t) = (40 - 24e^{-2500t}) \text{ V}, \quad t \geq 0.$$

- Specify the numerical values of  $I_s$ ,  $V_o$ ,  $R$ ,  $C$ , and  $\tau$ .
  - How many microseconds after the switch has been closed does the energy stored in the capacitor reach 81% of its final value?
- 7.59**
- Use component values from Appendix H to create a first-order  $RC$  circuit (see Fig. 7.21) with a time constant of 250 ms. Use a single capacitor and a network of resistors, if necessary. Draw your circuit.
  - Suppose the capacitor you chose in part (a) has an initial voltage drop of 100 V. At  $t = 0$ , a switch connects a current source with a value of 1 mA in parallel with the capacitor and equivalent resistance. Write an expression for the voltage drop across the capacitor for  $t \geq 0$ .
  - Using your result from part (b), calculate the time at which the voltage drop across the capacitor reaches 50 V.

**7.60** The switch in the circuit shown in Fig. P7.60 opens at  $t = 0$  after being closed for a long time. How many milliseconds after the switch opens is the energy stored in the capacitor 36% of its final value?

PSPICE  
MULTISIM

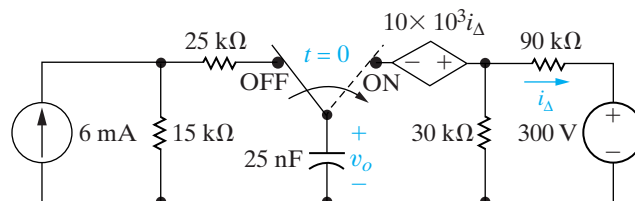
Figure P7.60



**7.61** The switch in the circuit shown in Fig. P7.61 has been in the OFF position for a long time. At  $t = 0$ , the switch moves instantaneously to the ON position. Find  $v_o(t)$  for  $t \geq 0$ .

PSPICE  
MULTISIM

Figure P7.61

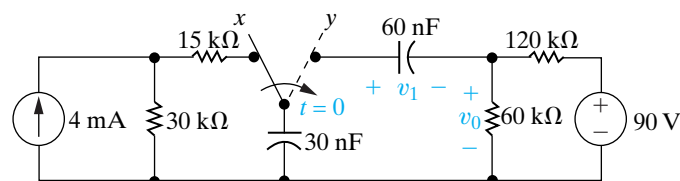


**7.62** Assume that the switch in the circuit of Fig. P7.61 has been in the ON position for a long time before switching instantaneously to the OFF position at  $t = 0$ . Find  $v_o(t)$  for  $t \geq 0$ .

PSPICE  
MULTISIM

- 7.63**
- Derive Eq. 7.52 by first converting the Norton equivalent circuit shown in Fig. 7.21 to a Thévenin equivalent and then summing the voltages around the closed loop, using the capacitor current  $i$  as the relevant variable.
  - Use the separation of variables technique to find the solution to Eq. 7.52. Verify that your solution agrees with that of Eq. 7.53.
- 7.64** The switch in the circuit in Fig. P7.64 has been in position  $x$  for a long time. The initial charge on the 60 nF capacitor is zero. At  $t = 0$ , the switch moves instantaneously to position  $y$ .
- Find  $v_o(t)$  for  $t \geq 0^+$ .
  - Find  $v_1(t)$  for  $t \geq 0$ .

Figure P7.64



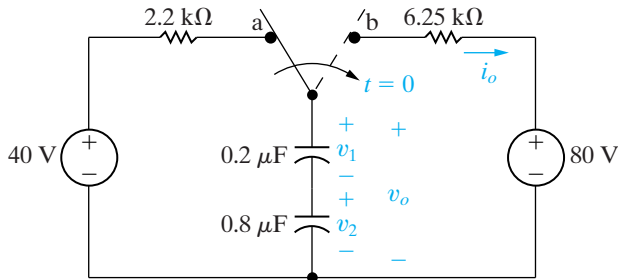
**7.65** The switch in the circuit of Fig. P7.65 has been in position a for a long time. At  $t = 0$ , it moves instantaneously to position b. For  $t \geq 0^+$ , find

PSPICE  
MULTISIM

- $v_o(t)$ .
- $i_o(t)$ .
- $v_1(t)$ .

- d)  $v_2(t)$ .
- e) the energy trapped in the capacitors as  $t \rightarrow \infty$ .

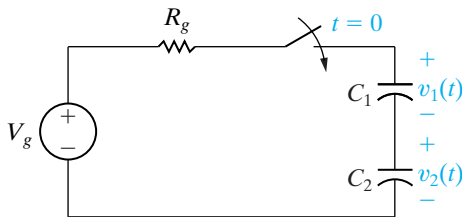
Figure P7.65



**7.66** There is no energy stored in the capacitors  $C_1$  and  $C_2$  at the time the switch is closed in the circuit seen in Fig. P7.66.

- a) Derive the expressions for  $v_1(t)$  and  $v_2(t)$  for  $t \geq 0$ .
- b) Use the expressions derived in (a) to find  $v_1(\infty)$  and  $v_2(\infty)$ .

Figure P7.66



**Section 7.4**

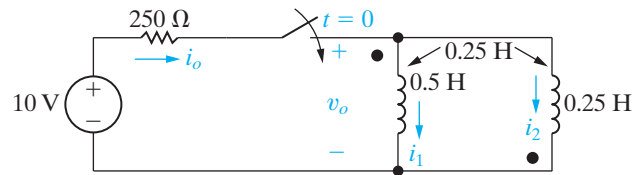
**7.67** Repeat (a) and (b) in Example 7.10 if the mutual inductance is reduced to zero.

**7.68** There is no energy stored in the circuit in Fig. P7.68 at the time the switch is closed.

PSPICE  
MULTISIM

- a) Find  $i_o(t)$  for  $t \geq 0$ .
- b) Find  $v_o(t)$  for  $t \geq 0^+$ .
- c) Find  $i_1(t)$  for  $t \geq 0$ .
- d) Find  $i_2(t)$  for  $t \geq 0$ .
- e) Do your answers make sense in terms of known circuit behavior?

Figure P7.68

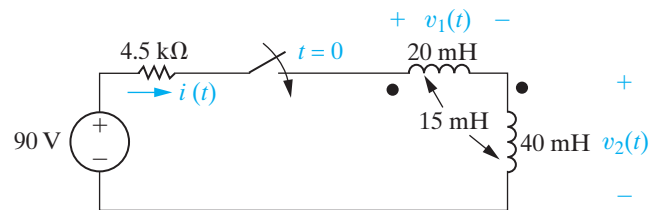


**7.69** There is no energy stored in the circuit in Fig. P7.69 at the time the switch is closed.

PSPICE  
MULTISIM

- a) Find  $i(t)$  for  $t \geq 0$ .
- b) Find  $v_1(t)$  for  $t \geq 0^+$ .
- c) Find  $v_2(t)$  for  $t \geq 0$ .
- d) Do your answers make sense in terms of known circuit behavior?

Figure P7.69



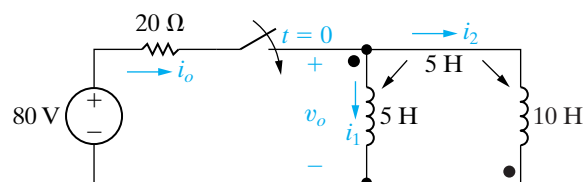
**7.70** Repeat Problem 7.69 if the dot on the 40 mH coil is at the bottom of the coil.

PSPICE  
MULTISIM

**7.71** There is no energy stored in the circuit of Fig. P7.71 at the time the switch is closed.

- a) Find  $i_o(t)$  for  $t \geq 0$ .
- b) Find  $v_o(t)$  for  $t \geq 0^+$ .
- c) Find  $i_1(t)$  for  $t \geq 0$ .
- d) Find  $i_2(t)$  for  $t \geq 0$ .
- e) Do your answers make sense in terms of known circuit behavior?

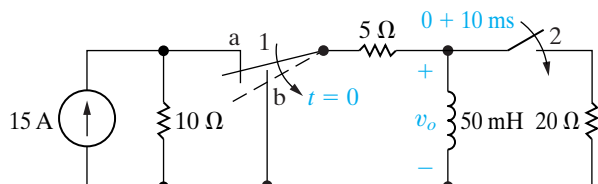
Figure P7.71



## Section 7.5

**7.72** The action of the two switches in the circuit seen in Fig. P7.72 is as follows. For  $t < 0$ , switch 1 is in position a and switch 2 is open. This state has existed for a long time. At  $t = 0$ , switch 1 moves instantaneously from position a to position b, while switch 2 remains open. Ten milliseconds after switch 1 operates, switch 2 closes, remains closed for 10 ms and then opens. Find  $v_o(t)$  25 ms after switch 1 moves to position b.

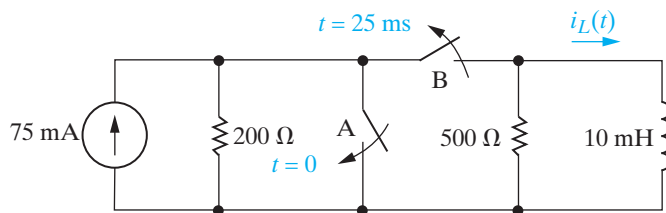
Figure P7.72



**7.73** For the circuit in Fig. P7.72, how many milliseconds after switch 1 moves to position b is the energy stored in the inductor 4% of its initial value?

**7.74** In the circuit in Fig. P7.74, switch A has been open and switch B has been closed for a long time. At  $t = 0$ , switch A closes. Twenty-five milliseconds after switch A closes, switch B opens. Find  $i_L(t)$  for  $t \geq 0$ .

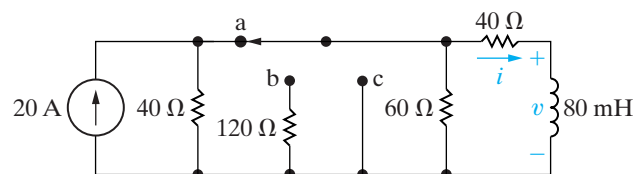
Figure P7.74



**7.75** The switch in the circuit shown in Fig. P7.75 has been in position a for a long time. At  $t = 0$ , the switch is moved to position b, where it remains for 1 ms. The switch is then moved to position c, where it remains indefinitely. Find

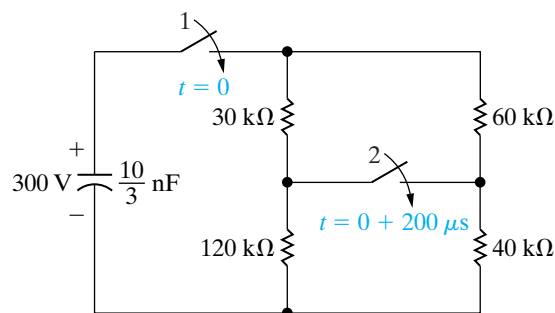
- $i(0^+)$ .
- $i(200 \mu\text{s})$ .
- $i(6 \text{ ms})$ .
- $v(1^- \text{ ms})$ .
- $v(1^+ \text{ ms})$ .

Figure P7.75



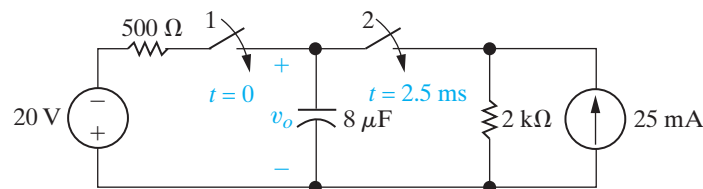
**7.76** The capacitor in the circuit seen in Fig. P7.76 has been charged to 300 V. At  $t = 0$ , switch 1 closes, causing the capacitor to discharge into the resistive network. Switch 2 closes 200  $\mu\text{s}$  after switch 1 closes. Find the magnitude and direction of the current in the second switch 300  $\mu\text{s}$  after switch 1 closes.

Figure P7.76



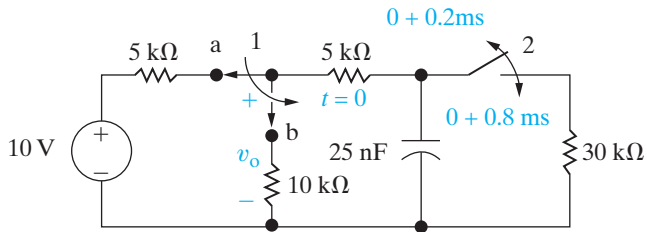
**7.77** There is no energy stored in the capacitor in the circuit in Fig. P7.77 when switch 1 closes at  $t = 0$ . Switch 2 closes 2.5 milliseconds later. Find  $v_o(t)$  for  $t \geq 0$ .

Figure P7.77



- 7.78** In the circuit in Fig. P7.78, switch 1 has been in position a and switch 2 has been closed for a long time. At  $t = 0$ , switch 1 moves instantaneously to position b. Two hundred microseconds later, switch 2 opens, remains open for  $600 \mu\text{s}$ , and then recloses. Find  $v_o$  1 ms after switch 1 makes contact with terminal b.

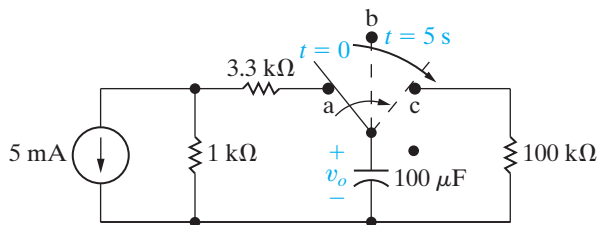
Figure P7.78



- 7.79** For the circuit in Fig. P7.78, what percentage of the initial energy stored in the 25 nF capacitor is dissipated in the 30 kΩ resistor?

- 7.80** The switch in the circuit in Fig. P7.80 has been in position a for a long time. At  $t = 0$ , it moves instantaneously to position b, where it remains for five seconds before moving instantaneously to position c. Find  $v_o$  for  $t \geq 0$ .

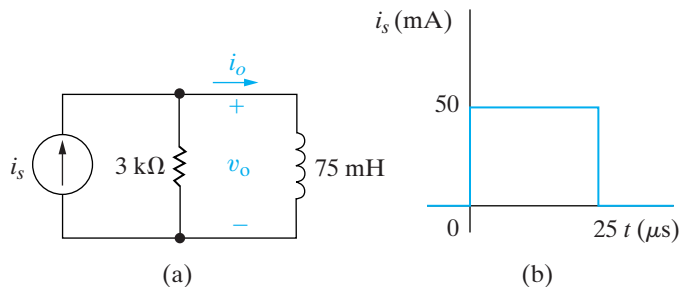
Figure P7.80



- 7.81** The current source in the circuit in Fig. P7.81(a) generates the current pulse shown in Fig. P7.81(b). There is no energy stored at  $t = 0$ .

- Derive the numerical expressions for  $v_o(t)$  for the time intervals  $t < 0$ ,  $0 \leq t \leq 25 \mu\text{s}$ , and  $25 \mu\text{s} \leq t < \infty$ .
- Calculate  $v_o(25^- \mu\text{s})$  and  $v_o(25^+ \mu\text{s})$ .
- Calculate  $i_o(25^- \mu\text{s})$  and  $i_o(25^+ \mu\text{s})$ .

Figure P7.81

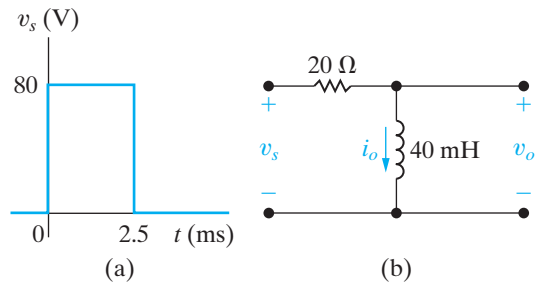


- 7.82** The voltage waveform shown in Fig. P7.82(a) is applied to the circuit of Fig. P7.82(b). The initial current in the inductor is zero.

PSPICE  
MULTISIM

- Calculate  $v_o(t)$ .
- Make a sketch of  $v_o(t)$  versus  $t$ .
- Find  $i_o$  at  $t = 5 \text{ ms}$ .

Figure P7.82

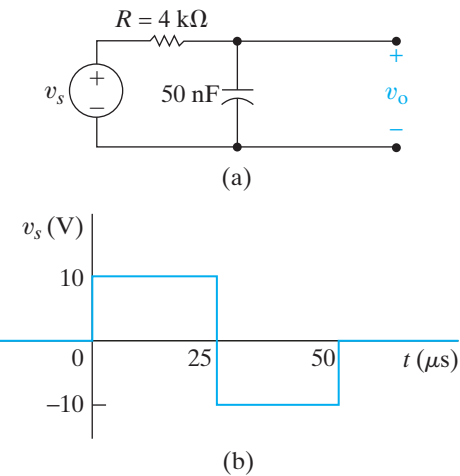


- 7.83** The voltage signal source in the circuit in Fig. P7.83(a) is generating the signal shown in Fig. P7.83(b). There is no stored energy at  $t = 0$ .

PSPICE  
MULTISIM

- Derive the expressions for  $v_o(t)$  that apply in the intervals  $t < 0$ ;  $0 \leq t \leq 25 \mu\text{s}$ ;  $25 \mu\text{s} \leq t \leq 50 \mu\text{s}$ ; and  $50 \mu\text{s} \leq t < \infty$ .
- Sketch  $v_o$  and  $v_s$  on the same coordinate axes.
- Repeat (a) and (b) with  $R$  reduced to  $800 \Omega$ .

Figure P7.83

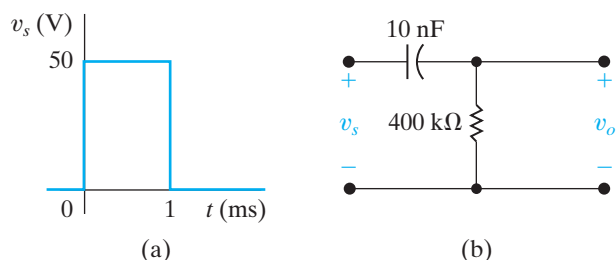


- 7.84** The voltage waveform shown in Fig. P7.84(a) is applied to the circuit of Fig. P7.84(b). The initial voltage on the capacitor is zero.

PSPICE  
MULTISIM

- Calculate  $v_o(t)$ .
- Make a sketch of  $v_o(t)$  versus  $t$ .

Figure P7.84

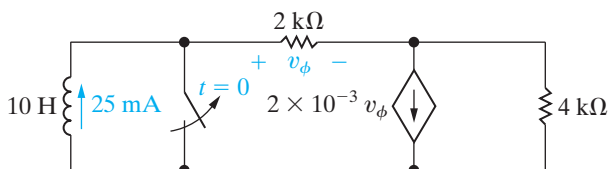


## Section 7.6

**7.85** The inductor current in the circuit in Fig. P7.85 is 25 mA at the instant the switch is opened. The inductor will malfunction whenever the magnitude of the inductor current equals or exceeds 5 A. How long after the switch is opened does the inductor malfunction?

PSPICE  
MULTISIM

Figure P7.85

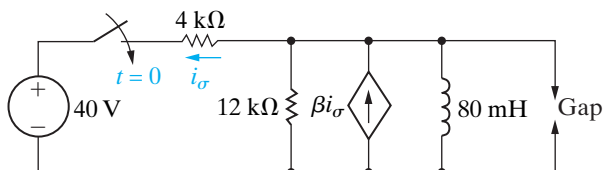


**7.86** The gap in the circuit seen in Fig. P7.86 will arc over whenever the voltage across the gap reaches 30 kV. The initial current in the inductor is zero. The value of  $\beta$  is adjusted so the Thévenin resistance with respect to the terminals of the inductor is  $-4 \text{ k}\Omega$ .

PSPICE  
MULTISIM

- What is the value of  $\beta$ ?
- How many microseconds after the switch has been closed will the gap arc over?

Figure P7.86

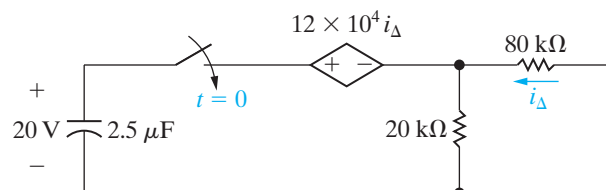


**7.87** The capacitor in the circuit shown in Fig. P7.87 is charged to 20 V at the time the switch is closed. If the capacitor ruptures when its terminal voltage

PSPICE  
MULTISIM

equals or exceeds 20 kV, how long does it take to rupture the capacitor?

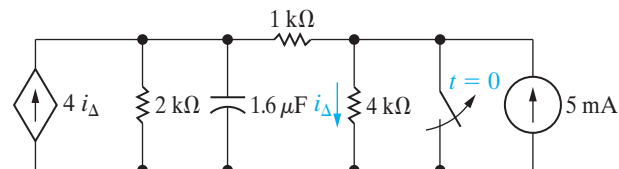
Figure P7.87



**7.88** The switch in the circuit in Fig. P7.88 has been closed for a long time. The maximum voltage rating of the  $1.6 \mu\text{F}$  capacitor is 14.4 kV. How long after the switch is opened does the voltage across the capacitor reach the maximum voltage rating?

PSPICE  
MULTISIM

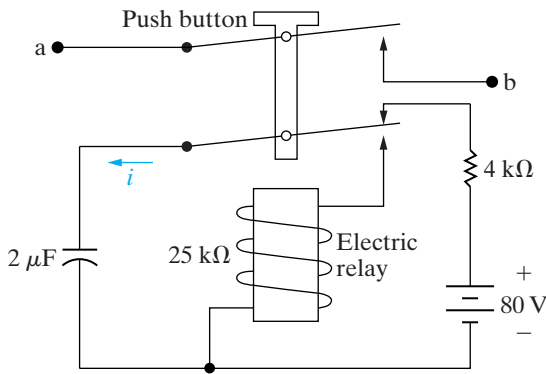
Figure P7.88



**7.89** The circuit shown in Fig. P7.89 is used to close the switch between a and b for a predetermined length of time. The electric relay holds its contact arms down as long as the voltage across the relay coil exceeds 5 V. When the coil voltage equals 5 V, the relay contacts return to their initial position by a mechanical spring action. The switch between a and b is initially closed by momentarily pressing the push button. Assume that the capacitor is fully charged when the push button is first pushed down. The resistance of the relay coil is  $25 \text{ k}\Omega$ , and the inductance of the coil is negligible.

- How long will the switch between a and b remain closed?
- Write the numerical expression for  $i$  from the time the relay contacts first open to the time the capacitor is completely charged.
- How many milliseconds (after the circuit between a and b is interrupted) does it take the capacitor to reach 85% of its final value?

Figure P7.89

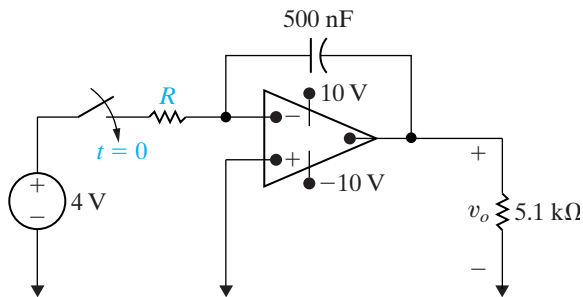


Section 7.7

**7.90** The energy stored in the capacitor in the circuit shown in Fig. P7.90 is zero at the instant the switch is closed. The ideal operational amplifier reaches saturation in 15 ms. What is the numerical value of  $R$  in kilo-ohms?

PSPICE  
MULTISIM

Figure P7.90



**7.91** At the instant the switch is closed in the circuit of Fig. P7.90, the capacitor is charged to 6 V, positive at the right-hand terminal. If the ideal operational amplifier saturates in 40 ms, what is the value of  $R$ ?

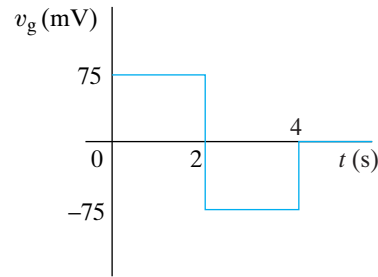
PSPICE  
MULTISIM

**7.92** The voltage pulse shown in Fig. P7.92(a) is applied to the ideal integrating amplifier shown in Fig. P7.92(b). Derive the numerical expressions for  $v_o(t)$  when  $v_o(0) = 0$  for the time intervals

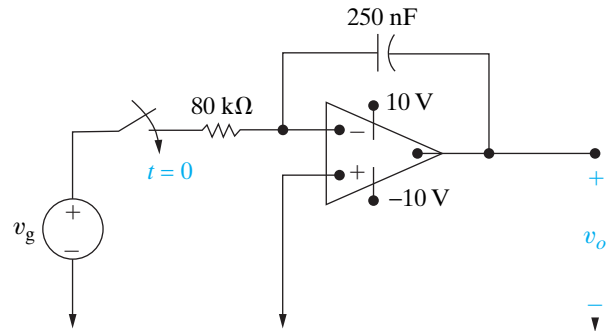
PSPICE  
MULTISIM

- a)  $t < 0$ .
- b)  $0 \leq t \leq 2$  s.
- c)  $2 \text{ s} \leq t \leq 4$  s.
- d)  $4 \text{ s} \leq t$

Figure P7.92



(a)



(b)

**7.93** Repeat Problem 7.92 with a 4 MΩ resistor placed across the 250 nF feedback capacitor.

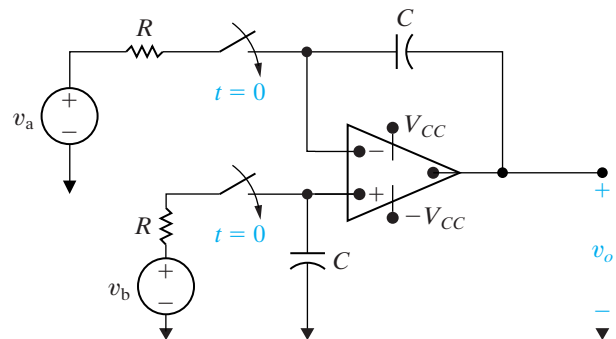
PSPICE  
MULTISIM

**7.94** There is no energy stored in the capacitors in the circuit shown in Fig. P7.94 at the instant the two switches close. Assume the op amp is ideal.

PSPICE  
MULTISIM

- a) Find  $v_o$  as a function of  $v_a$ ,  $v_b$ ,  $R$ , and  $C$ .
- b) On the basis of the result obtained in (a), describe the operation of the circuit.
- c) How long will it take to saturate the amplifier if  $v_a = 40$  mV;  $v_b = 15$  mV;  $R = 50$  kΩ;  $C = 10$  nF; and  $V_{CC} = 6$  V?

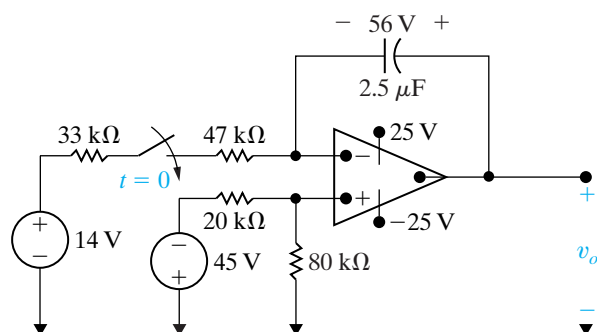
Figure P7.94





- 7.95** At the instant the switch of Fig. P7.95 is closed, the voltage on the capacitor is 56 V. Assume an ideal operational amplifier. How many milliseconds after the switch is closed will the output voltage  $v_o$  equal zero?

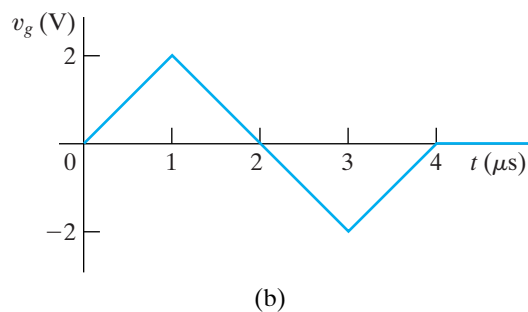
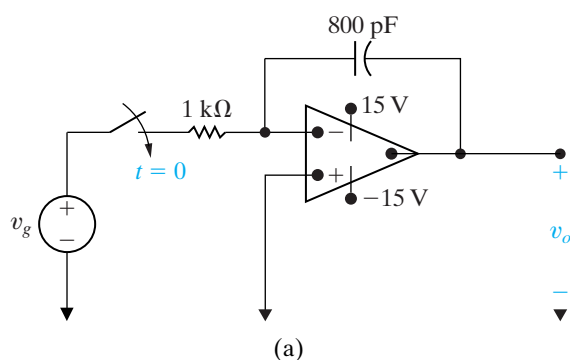
Figure P7.95



- 7.96** The voltage source in the circuit in Fig. P7.96(a) is generating the triangular waveform shown in Fig. P7.96(b). Assume the energy stored in the capacitor is zero at  $t = 0$  and the op amp is ideal.

- a) Derive the numerical expressions for  $v_o(t)$  for the following time intervals:  $0 \leq t \leq 1 \mu\text{s}$ ;  $1 \mu\text{s} \leq t \leq 3 \mu\text{s}$ ; and  $3 \mu\text{s} \leq t \leq 4 \mu\text{s}$ .
- b) Sketch the output waveform between 0 and  $4 \mu\text{s}$ .
- c) If the triangular input voltage continues to repeat itself for  $t > 4 \mu\text{s}$ , what would you expect the output voltage to be? Explain.

Figure P7.96

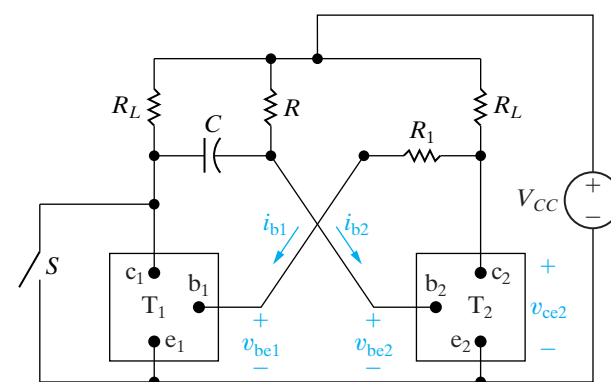


## Sections 7.1–7.7

- 7.97** The circuit shown in Fig. P7.97 is known as a *monostable multivibrator*. The adjective *monostable* is used to describe the fact that the circuit has one stable state. That is, if left alone, the electronic switch  $T_2$  will be ON, and  $T_1$  will be OFF. (The operation of the ideal transistor switch is described in detail in Problem 7.99.)  $T_2$  can be turned OFF by momentarily closing the switch  $S$ . After  $S$  returns to its open position,  $T_2$  will return to its ON state.

- a) Show that if  $T_2$  is ON,  $T_1$  is OFF and will stay OFF.
- b) Explain why  $T_2$  is turned OFF when  $S$  is momentarily closed.
- c) Show that  $T_2$  will stay OFF for  $RC \ln 2$ .

Figure P7.97



- 7.98** The parameter values in the circuit in Fig. P7.97 are  $V_{CC} = 6 \text{ V}$ ;  $R_1 = 5.0 \text{ k}\Omega$ ;  $R_L = 20 \text{ k}\Omega$ ;  $C = 250 \text{ pF}$ ; and  $R = 23,083 \Omega$ .

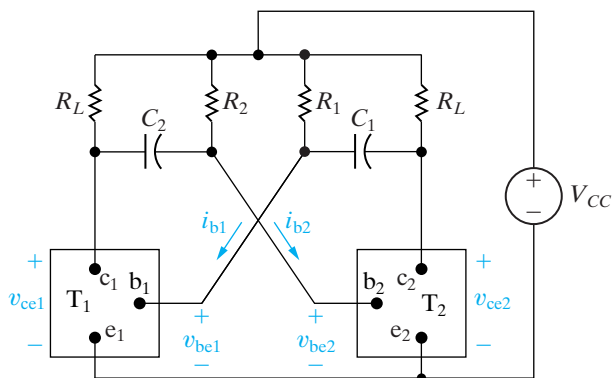
- a) Sketch  $v_{ce2}$  versus  $t$ , assuming that after  $S$  is momentarily closed, it remains open until the circuit has reached its stable state. Assume  $S$  is closed at  $t = 0$ . Make your sketch for the interval  $-5 \leq t \leq 10 \mu\text{s}$ .
- b) Repeat (a) for  $i_{b2}$  versus  $t$ .

- 7.99** The circuit shown in Fig. P7.99 is known as an *astable multivibrator* and finds wide application in pulse circuits. The purpose of this problem is to relate the charging and discharging of the capacitors to the operation of the circuit. The key to analyzing the circuit is to understand the behavior of the ideal transistor switches  $T_1$  and  $T_2$ . The circuit is designed so that the switches automatically alternate between ON and OFF. When  $T_1$  is OFF,  $T_2$  is ON and vice versa. Thus in the analysis of this circuit, we assume a switch is either ON or OFF. We also assume that the ideal transistor switch can change its state instantaneously. In other words, it can snap from OFF to ON and vice versa. When a transistor switch is

ON, (1) the base current  $i_b$  is greater than zero, (2) the terminal voltage  $v_{be}$  is zero, and (3) the terminal voltage  $v_{ce}$  is zero. Thus, when a transistor switch is ON, it presents a short circuit between the terminals b,e and c,e. When a transistor switch is OFF, (1) the terminal voltage  $v_{be}$  is negative, (2) the base current is zero, and (3) there is an open circuit between the terminals c,e. Thus when a transistor switch is OFF, it presents an open circuit between the terminals b,e and c,e. Assume that  $T_2$  has been ON and has just snapped OFF, while  $T_1$  has been OFF and has just snapped ON. You may assume that at this instance,  $C_2$  is charged to the supply voltage  $V_{CC}$ , and the charge on  $C_1$  is zero. Also assume  $C_1 = C_2$  and  $R_1 = R_2 = 10R_L$ .

- Derive the expression for  $v_{be2}$  during the interval that  $T_2$  is OFF.
- Derive the expression for  $v_{ce2}$  during the interval that  $T_2$  is OFF.
- Find the length of time  $T_2$  is OFF.
- Find the value of  $v_{ce2}$  at the end of the interval that  $T_2$  is OFF.
- Derive the expression for  $i_{b1}$  during the interval that  $T_2$  is OFF.
- Find the value of  $i_{b1}$  at the end of the interval that  $T_2$  is OFF.
- Sketch  $v_{ce2}$  versus  $t$  during the interval that  $T_2$  is OFF.
- Sketch  $i_{b1}$  versus  $t$  during the interval that  $T_2$  is OFF.

Figure P7.99



**7.100** The component values in the circuit of Fig. P7.99 are  $V_{CC} = 9\text{ V}$ ;  $R_L = 3\text{ k}\Omega$ ;  $C_1 = C_2 = 2\text{ nF}$ ; and  $R_1 = R_2 = 18\text{ k}\Omega$ .

- How long is  $T_2$  in the OFF state during one cycle of operation?
- How long is  $T_2$  in the ON state during one cycle of operation?
- Repeat (a) for  $T_1$ .
- Repeat (b) for  $T_1$ .
- At the first instant after  $T_1$  turns ON, what is the value of  $i_{b1}$ ?
- At the instant just before  $T_1$  turns OFF, what is the value of  $i_{b1}$ ?
- What is the value of  $v_{ce2}$  at the instant just before  $T_2$  turns ON?

**7.101** Repeat Problem 7.100 with  $C_1 = 3\text{ nF}$  and  $C_2 = 2.8\text{ nF}$ . All other component values are unchanged.

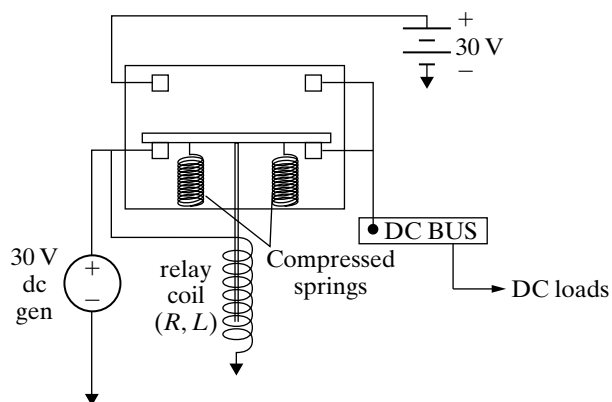
**7.102** The astable multivibrator circuit in Fig. P7.99 is to satisfy the following criteria: (1) One transistor switch is to be ON for  $48\text{ }\mu\text{s}$  and OFF for  $36\text{ }\mu\text{s}$  for each cycle; (2)  $R_L = 2\text{ k}\Omega$ ; (3)  $V_{CC} = 5\text{ V}$ ; (4)  $R_1 = R_2$ ; and (5)  $6R_L \leq R_1 \leq 50R_L$ . What are the limiting values for the capacitors  $C_1$  and  $C_2$ ?

**7.103** The relay shown in Fig. P7.103 connects the 30 V dc generator to the dc bus as long as the relay current is greater than 0.4 A. If the relay current drops to 0.4 A or less, the spring-loaded relay immediately connects the dc bus to the 30 V standby battery. The resistance of the relay winding is  $60\text{ }\Omega$ . The inductance of the relay winding is to be determined.

- Assume the prime motor driving the 30 V dc generator abruptly slows down, causing the generated voltage to drop suddenly to 21 V. What value of  $L$  will assure that the standby battery will be connected to the dc bus in 0.5 seconds?
- Using the value of  $L$  determined in (a), state how long it will take the relay to operate if the generated voltage suddenly drops to zero.

PRACTICAL PERSPECTIVE

Figure P7.103



- 7.104** Derive the expression for heart rate in beats per minute given the values of  $R$  and  $C$  and assuming that the capacitor discharges when its voltage reaches 75% of the source voltage  $V_s$ . The expression, given in the Practical Perspective, is repeated here for convenience:

$$H = \frac{60}{-RC \ln 0.25} \quad [\text{beats per minute}].$$

- 7.105** Use an expression similar to the one derived in Problem 7.104 to calculate the heart rate in beats per minute for  $R = 150 \text{ k}\Omega$ ,  $C = 6 \mu\text{F}$ , if the capacitor discharges when its voltage reaches 60% of the source voltage  $V_s$ .

- 7.106** Show that the resistance required to achieve a heart rate  $H$ , in beats per minute, is given by the equation

$$R = \frac{-60}{HC \ln\left(1 - \frac{V_{\max}}{V_s}\right)},$$

where  $C$  is the capacitance,  $V_s$  is the source voltage, and  $V_{\max}$  is the capacitor voltage at which discharge occurs.

- 7.107** Use the expression derived in Problem 7.106 to calculate the resistance required to achieve a heart rate of 70 beats per minute using a capacitance of  $2.5 \mu\text{F}$  and assuming that the capacitor discharges when its voltage reaches 68% of the source voltage.

## CHAPTER CONTENTS

- 8.1 Introduction to the Natural Response of a Parallel *RLC* Circuit p. 266
- 8.2 The Forms of the Natural Response of a Parallel *RLC* Circuit p. 270
- 8.3 The Step Response of a Parallel *RLC* Circuit p. 280
- 8.4 The Natural and Step Response of a Series *RLC* Circuit p. 285
- 8.5 A Circuit with Two Integrating Amplifiers p. 289

## ✓ CHAPTER OBJECTIVES

- 1 Be able to determine the natural response and the step response of parallel *RLC* circuits.
- 2 Be able to determine the natural response and the step response of series *RLC* circuits.

# Natural and Step Responses of *RLC* Circuits

**In this chapter,** discussion of the natural response and step response of circuits containing both inductors and capacitors is limited to two simple structures: the parallel *RLC* circuit and the series *RLC* circuit. Finding the natural response of a parallel *RLC* circuit consists of finding the voltage created across the parallel branches by the release of energy stored in the inductor or capacitor or both. The task is defined in terms of the circuit shown in Fig. 8.1 on page 266. The initial voltage on the capacitor,  $V_0$ , represents the initial energy stored in the capacitor. The initial current through the inductor,  $I_0$ , represents the initial energy stored in the inductor. If the individual branch currents are of interest, you can find them after determining the terminal voltage.

We derive the step response of a parallel *RLC* circuit by using Fig. 8.2 on page 266. We are interested in the voltage that appears across the parallel branches as a result of the sudden application of a dc current source. Energy may or may not be stored in the circuit when the current source is applied.

Finding the natural response of a series *RLC* circuit consists of finding the current generated in the series-connected elements by the release of initially stored energy in the inductor, capacitor, or both. The task is defined by the circuit shown in Fig. 8.3 on page 266. As before, the initial inductor current,  $I_0$ , and the initial capacitor voltage,  $V_0$ , represent the initially stored energy. If any of the individual element voltages are of interest, you can find them after determining the current.

We describe the step response of a series *RLC* circuit in terms of the circuit shown in Fig. 8.4 on page 266. We are interested in the current resulting from the sudden application of the dc voltage source. Energy may or may not be stored in the circuit when the switch is closed.

If you have not studied ordinary differential equations, derivation of the natural and step responses of parallel and series *RLC* circuits may be a bit difficult to follow. However, the results are important enough to warrant presentation at this time. We begin with the natural response of a parallel *RLC* circuit and cover this material over two sections: one to discuss the solution of the differential equation that describes the circuit and one to present the three distinct forms that the solution can take.

## Practical Perspective

### Clock for Computer Timing

The digital circuits found in most computers require a timing signal that synchronizes the operation of the circuits. Consider a laptop computer whose processor speed is 2 GHz. This means that the central processing unit for this computer can perform about  $2 \times 10^9$  simple operations every second.

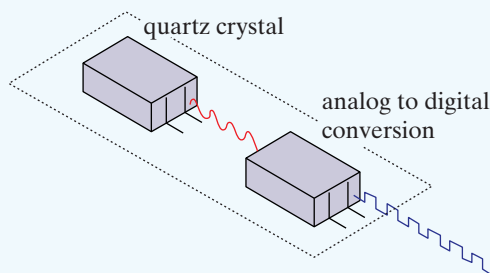
The timing signal, produced by a clock generator chip, is typically a square wave with the required clock frequency. The square wave is obtained from a sinusoidal wave with the required clock frequency. Typically, the sinusoidal wave is

generated by precisely-cut quartz crystal with an applied voltage. The crystal produces a very stable frequency suitable for synchronizing digital circuits.

But we can also generate a sinusoidal wave using a circuit with an inductor and a capacitor. By choosing the values of inductance and capacitance, we can create a sinusoid with a specific frequency. We will examine such a design once we have presented the fundamental concepts of second-order circuits.

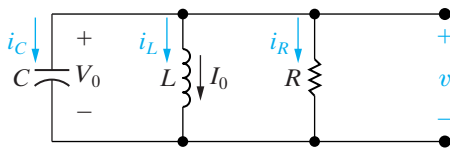


Scanrail / fotolia

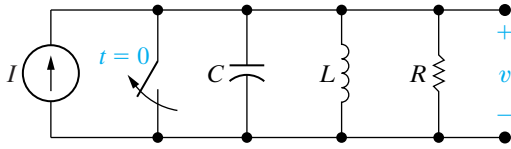


David J. Green / Alamy

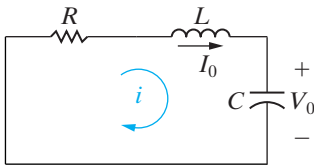




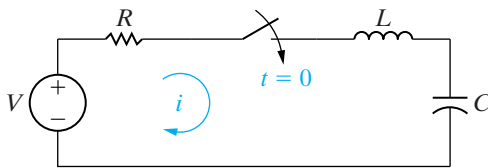
**Figure 8.1** ▲ A circuit used to illustrate the natural response of a parallel RLC circuit.



**Figure 8.2** ▲ A circuit used to illustrate the step response of a parallel RLC circuit.



**Figure 8.3** ▲ A circuit used to illustrate the natural response of a series RLC circuit.



**Figure 8.4** ▲ A circuit used to illustrate the step response of a series RLC circuit.

After introducing these three forms, we show that the same forms apply to the step response of a parallel RLC circuit as well as to the natural and step responses of series RLC circuits.

## 8.1 Introduction to the Natural Response of a Parallel RLC Circuit

The first step in finding the natural response of the circuit shown in Fig. 8.1 is to derive the differential equation that the voltage  $v$  must satisfy. We choose to find the voltage first, because it is the same for each component. After that, a branch current can be found by using the current-voltage relationship for the branch component. We easily obtain the differential equation for the voltage by summing the currents away from the top node, where each current is expressed as a function of the unknown voltage  $v$ :

$$\frac{v}{R} + \frac{1}{L} \int_0^t v d\tau + I_0 + C \frac{dv}{dt} = 0. \quad (8.1)$$

We eliminate the integral in Eq. 8.1 by differentiating once with respect to  $t$ , and, because  $I_0$  is a constant, we get

$$\frac{1}{R} \frac{dv}{dt} + \frac{v}{L} + C \frac{d^2v}{dt^2} = 0. \quad (8.2)$$

We now divide through Eq. 8.2 by the capacitance  $C$  and arrange the derivatives in descending order:

$$\frac{d^2v}{dt^2} + \frac{1}{RC} \frac{dv}{dt} + \frac{v}{LC} = 0. \quad (8.3)$$

Comparing Eq. 8.3 with the differential equations derived in Chapter 7 reveals that they differ by the presence of the term involving the second derivative. Equation 8.3 is an ordinary, second-order differential equation with constant coefficients. Circuits in this chapter contain both inductors and capacitors, so the differential equation describing these circuits is of the second order. Therefore, we sometimes call such circuits **second-order circuits**.

### The General Solution of the Second-Order Differential Equation

We can't solve Eq. 8.3 by separating the variables and integrating as we were able to do with the first-order equations in Chapter 7. The classical approach to solving Eq. 8.3 is to assume that the solution is of exponential form, that is, to assume that the voltage is of the form

$$v = Ae^{st}, \quad (8.4)$$

where  $A$  and  $s$  are unknown constants.

Before showing how this assumption leads to the solution of Eq. 8.3, we need to show that it is rational. The strongest argument we can make in favor of Eq. 8.4 is to note from Eq. 8.3 that the second derivative of the

solution, plus a constant times the first derivative, plus a constant times the solution itself, must sum to zero for all values of  $t$ . This can occur only if higher order derivatives of the solution have the same form as the solution. The exponential function satisfies this criterion. A second argument in favor of Eq. 8.4 is that the solutions of all the first-order equations we derived in Chapter 7 were exponential. It seems reasonable to assume that the solution of the second-order equation also involves the exponential function.

If Eq. 8.4 is a solution of Eq. 8.3, it must satisfy Eq. 8.3 for all values of  $t$ . Substituting Eq. 8.4 into Eq. 8.3 generates the expression

$$As^2e^{st} + \frac{As}{RC}e^{st} + \frac{Ae^{st}}{LC} = 0,$$

or

$$Ae^{st}\left(s^2 + \frac{s}{RC} + \frac{1}{LC}\right) = 0, \quad (8.5)$$

which can be satisfied for all values of  $t$  only if  $A$  is zero or the parenthetical term is zero, because  $e^{st} \neq 0$  for any finite values of  $st$ . We cannot use  $A = 0$  as a general solution because to do so implies that the voltage is zero for all time—a physical impossibility if energy is stored in either the inductor or capacitor. Therefore, in order for Eq. 8.4 to be a solution of Eq. 8.3, the parenthetical term in Eq. 8.5 must be zero, or

$$s^2 + \frac{s}{RC} + \frac{1}{LC} = 0. \quad (8.6) \quad \blacktriangleleft \text{Characteristic equation, parallel RLC circuit}$$

Equation 8.6 is called the **characteristic equation** of the differential equation because the roots of this quadratic equation determine the mathematical character of  $v(t)$ .

The two roots of Eq. 8.6 are

$$s_1 = -\frac{1}{2RC} + \sqrt{\left(\frac{1}{2RC}\right)^2 - \frac{1}{LC}}, \quad (8.7)$$

$$s_2 = -\frac{1}{2RC} - \sqrt{\left(\frac{1}{2RC}\right)^2 - \frac{1}{LC}}. \quad (8.8)$$

If either root is substituted into Eq. 8.4, the assumed solution satisfies the given differential equation, that is, Eq. 8.3. Note from Eq. 8.5 that this result holds regardless of the value of  $A$ . Therefore, both

$$v = A_1e^{s_1t} \text{ and}$$

$$v = A_2e^{s_2t}$$



satisfy Eq. 8.3. Denoting these two solutions  $v_1$  and  $v_2$ , respectively, we can show that their sum also is a solution. Specifically, if we let

$$v = v_1 + v_2 = A_1 e^{s_1 t} + A_2 e^{s_2 t}, \quad (8.9)$$

then

$$\frac{dv}{dt} = A_1 s_1 e^{s_1 t} + A_2 s_2 e^{s_2 t}, \quad (8.10)$$

$$\frac{d^2 v}{dt^2} = A_1 s_1^2 e^{s_1 t} + A_2 s_2^2 e^{s_2 t}. \quad (8.11)$$

Substituting Eqs. 8.9–8.11 into Eq. 8.3 gives

$$A_1 e^{s_1 t} \left( s_1^2 + \frac{1}{RC} s_1 + \frac{1}{LC} \right) + A_2 e^{s_2 t} \left( s_2^2 + \frac{1}{RC} s_2 + \frac{1}{LC} \right) = 0. \quad (8.12)$$

But each parenthetical term is zero because by definition  $s_1$  and  $s_2$  are roots of the characteristic equation. Hence the natural response of the parallel RLC circuit shown in Fig. 8.1 is of the form

$$v = A_1 e^{s_1 t} + A_2 e^{s_2 t}. \quad (8.13)$$

Equation 8.13 is a repeat of the assumption made in Eq. 8.9. We have shown that  $v_1$  is a solution,  $v_2$  is a solution, and  $v_1 + v_2$  is a solution. Therefore, the general solution of Eq. 8.3 has the form given in Eq. 8.13. The roots of the characteristic equation ( $s_1$  and  $s_2$ ) are determined by the circuit parameters  $R$ ,  $L$ , and  $C$ . The initial conditions determine the values of the constants  $A_1$  and  $A_2$ . Note that the form of Eq. 8.13 must be modified if the two roots  $s_1$  and  $s_2$  are equal. We discuss this modification when we turn to the critically damped voltage response in Section 8.2.

The behavior of  $v(t)$  depends on the values of  $s_1$  and  $s_2$ . Therefore the first step in finding the natural response is to determine the roots of the characteristic equation. We return to Eqs. 8.7 and 8.8 and rewrite them using a notation widely used in the literature:

$$s_1 = -\alpha + \sqrt{\alpha^2 - \omega_0^2}, \quad (8.14)$$

$$s_2 = -\alpha - \sqrt{\alpha^2 - \omega_0^2}, \quad (8.15)$$

where

**Neper frequency, parallel RLC circuit** ▶

$$\alpha = \frac{1}{2RC}, \quad (8.16)$$

**Resonant radian frequency, parallel RLC circuit** ▶

$$\omega_0 = \frac{1}{\sqrt{LC}}. \quad (8.17)$$

These results are summarized in Table 8.1.

TABLE 8.1 Natural Response Parameters of the Parallel RLC Circuit

Parameter	Terminology	Value In Natural Response
$s_1, s_2$	Characteristic roots	$s_1 = -\alpha + \sqrt{\alpha^2 - \omega_0^2}$ $s_2 = -\alpha - \sqrt{\alpha^2 - \omega_0^2}$
$\alpha$	Neper frequency	$\alpha = \frac{1}{2RC}$
$\omega_0$	Resonant radian frequency	$\omega_0 = \frac{1}{\sqrt{LC}}$

The exponent of  $e$  must be dimensionless, so both  $s_1$  and  $s_2$  (and hence  $\alpha$  and  $\omega_0$ ) must have the dimension of the reciprocal of time, or frequency. To distinguish among the frequencies  $s_1$ ,  $s_2$ ,  $\alpha$ , and  $\omega_0$ , we use the following terminology:  $s_1$  and  $s_2$  are referred to as *complex frequencies*,  $\alpha$  is called the *neper frequency*, and  $\omega_0$  is the *resonant radian frequency*. The full significance of this terminology unfolds as we move through the remaining chapters of this book. All these frequencies have the dimension of angular frequency per time. For complex frequencies, the neper frequency, and the resonant radian frequency, we specify values using the unit *radians per second* (rad/s). The nature of the roots  $s_1$  and  $s_2$  depends on the values of  $\alpha$  and  $\omega_0$ . There are three possible outcomes. First, if  $\omega_0^2 < \alpha^2$ , both roots will be real and distinct. For reasons to be discussed later, the voltage response is said to be **overdamped** in this case. Second, if  $\omega_0^2 > \alpha^2$ , both  $s_1$  and  $s_2$  will be complex and, in addition, will be conjugates of each other. In this situation, the voltage response is said to be **underdamped**. The third possible outcome is that  $\omega_0^2 = \alpha^2$ . In this case,  $s_1$  and  $s_2$  will be real and equal. Here the voltage response is said to be **critically damped**. As we shall see, damping affects the way the voltage response reaches its final (or steady-state) value. We discuss each case separately in Section 8.2.

Example 8.1 illustrates how the numerical values of  $s_1$  and  $s_2$  are determined by the values of  $R$ ,  $L$ , and  $C$ .

### Example 8.1 Finding the Roots of the Characteristic Equation of a Parallel RLC Circuit

- Find the roots of the characteristic equation that governs the transient behavior of the voltage shown in Fig. 8.5 if  $R = 200 \Omega$ ,  $L = 50 \text{ mH}$ , and  $C = 0.2 \mu\text{F}$ .
- Will the response be overdamped, underdamped, or critically damped?
- Repeat (a) and (b) for  $R = 312.5 \Omega$ .
- What value of  $R$  causes the response to be critically damped?

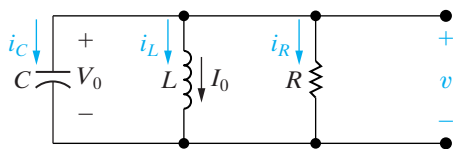


Figure 8.5 ▲ A circuit used to illustrate the natural response of a parallel RLC circuit.

### Solution

- For the given values of  $R$ ,  $L$ , and  $C$ ,

$$\alpha = \frac{1}{2RC} = \frac{10^6}{(400)(0.2)} = 1.25 \times 10^4 \text{ rad/s,}$$

$$\omega_0^2 = \frac{1}{LC} = \frac{(10^3)(10^6)}{(50)(0.2)} = 10^8 \text{ rad}^2/\text{s}^2.$$

From Eqs. 8.14 and 8.15,

$$\begin{aligned} s_1 &= -1.25 \times 10^4 + \sqrt{1.5625 \times 10^8 - 10^8} \\ &= -12,500 + 7500 = -5000 \text{ rad/s,} \end{aligned}$$

$$s_2 = -1.25 \times 10^4 - \sqrt{1.5625 \times 10^8 - 10^8}$$

b) The voltage response is overdamped because  $\omega_0^2 < \alpha^2$ .

c) For  $R = 312.5 \Omega$ ,

$$\alpha = \frac{10^6}{(625)(0.2)} = 8000 \text{ rad/s,}$$

$$\alpha^2 = 64 \times 10^6 = 0.64 \times 10^8 \text{ rad}^2/\text{s}^2.$$

As  $\omega_0^2$  remains at  $10^8 \text{ rad}^2/\text{s}^2$ ,

$$s_1 = -8000 + j6000 \text{ rad/s,}$$

$$s_2 = -8000 - j6000 \text{ rad/s.}$$

(In electrical engineering, the imaginary number  $\sqrt{-1}$  is represented by the letter  $j$ , because the letter  $i$  represents current.)

In this case, the voltage response is underdamped since  $\omega_0^2 > \alpha^2$ .

d) For critical damping,  $\alpha^2 = \omega_0^2$ , so

$$\left(\frac{1}{2RC}\right)^2 = \frac{1}{LC} = 10^8,$$

or

$$\frac{1}{2RC} = 10^4,$$

and

$$R = \frac{10^6}{(2 \times 10^4)(0.2)} = 250 \Omega.$$

### ASSESSMENT PROBLEM

**Objective 1—Be able to determine the natural response and the step response of parallel RLC circuits**

**8.1** The resistance and inductance of the circuit in Fig. 8.5 are  $100 \Omega$  and  $20 \text{ mH}$ , respectively.

- Find the value of  $C$  that makes the voltage response critically damped.
- If  $C$  is adjusted to give a neper frequency of  $5 \text{ krad/s}$ , find the value of  $C$  and the roots of the characteristic equation.
- If  $C$  is adjusted to give a resonant frequency of  $20 \text{ krad/s}$ , find the value of  $C$  and the roots of the characteristic equation.

**Answer:** (a)  $500 \text{ nF}$ ;

(b)  $C = 1 \mu\text{F}$ ,  
 $s_1 = -5000 + j5000 \text{ rad/s}$ ,  
 $s_2 = -5000 - j5000 \text{ rad/s}$ ;

(c)  $C = 125 \text{ nF}$ ,  
 $s_1 = -5359 \text{ rad/s}$ ,  
 $s_2 = -74,641 \text{ rad/s}$ .

*NOTE: Also try Chapter Problem 8.4.*

## 8.2 The Forms of the Natural Response of a Parallel RLC Circuit

So far we have seen that the behavior of a second-order RLC circuit depends on the values of  $s_1$  and  $s_2$ , which in turn depend on the circuit parameters  $R$ ,  $L$ , and  $C$ . Therefore, the first step in finding the natural response is to calculate these values and, relatedly, determine whether the response is over-, under-, or critically damped.

Completing the description of the natural response requires finding two unknown coefficients, such as  $A_1$  and  $A_2$  in Eq. 8.13. The method used to do this is based on matching the solution for the natural response to the initial conditions imposed by the circuit, which are the initial value of the current (or voltage) and the initial value of the first derivative of the current (or voltage). Note that these same initial conditions, plus the final value of the variable, will also be needed when finding the step response of a second-order circuit.

In this section, we analyze the natural response form for each of the three types of damping, beginning with the overdamped response. As we will see, the response equations, as well as the equations for evaluating the unknown coefficients, are slightly different for each of the three damping configurations. This is why we want to determine at the outset of the problem whether the response is over-, under-, or critically damped.

## The Overdamped Voltage Response

When the roots of the characteristic equation are real and distinct, the voltage response of a parallel  $RLC$  circuit is said to be overdamped. The solution for the voltage is of the form

$$v = A_1 e^{s_1 t} + A_2 e^{s_2 t}, \quad (8.18)$$

where  $s_1$  and  $s_2$  are the roots of the characteristic equation. The constants  $A_1$  and  $A_2$  are determined by the initial conditions, specifically from the values of  $v(0^+)$  and  $dv(0^+)/dt$ , which in turn are determined from the initial voltage on the capacitor,  $V_0$ , and the initial current in the inductor,  $I_0$ .

Next, we show how to use the initial voltage on the capacitor and the initial current in the inductor to find  $A_1$  and  $A_2$ . First we note from Eq. 8.18 that  $A_1$  and  $A_2$ . First we note from Eq. 8.18 that

$$v(0^+) = A_1 + A_2, \quad (8.19)$$

$$\frac{dv(0^+)}{dt} = s_1 A_1 + s_2 A_2. \quad (8.20)$$

With  $s_1$  and  $s_2$  known, the task of finding  $A_1$  and  $A_2$  reduces to finding  $v(0^+)$  and  $dv(0^+)/dt$ . The value of  $v(0^+)$  is the initial voltage on the capacitor  $V_0$ . We get the initial value of  $dv/dt$  by first finding the current in the capacitor branch at  $t = 0^+$ . Then,

$$\frac{dv(0^+)}{dt} = \frac{i_C(0^+)}{C}. \quad (8.21)$$

We use Kirchhoff's current law to find the initial current in the capacitor branch. We know that the sum of the three branch currents at  $t = 0^+$  must be zero. The current in the resistive branch at  $t = 0^+$  is the initial voltage  $V_0$  divided by the resistance, and the current in the inductive branch is  $I_0$ . Using the reference system depicted in Fig. 8.5, we obtain

$$i_C(0^+) = \frac{-V_0}{R} - I_0. \quad (8.22)$$

After finding the numerical value of  $i_C(0^+)$ , we use Eq. 8.21 to find the initial value of  $dv/dt$ .

We can summarize the process for finding the overdamped response,  $v(t)$ , as follows:

1. Find the roots of the characteristic equation,  $s_1$  and  $s_2$ , using the values of  $R$ ,  $L$ , and  $C$ .
2. Find  $v(0^+)$  and  $dv(0^+)/dt$  using circuit analysis.
3. Find the values of  $A_1$  and  $A_2$  by solving Eqs. 8.23 and 8.24 simultaneously:

$$v(0^+) = A_1 + A_2, \quad (8.23)$$

$$\frac{dv(0^+)}{dt} = \frac{i_C(0^+)}{C} = s_1 A_1 + s_2 A_2. \quad (8.24)$$

4. Substitute the values for  $s_1$ ,  $s_2$ ,  $A_1$ , and  $A_2$  into Eq. 8.18 to determine the expression for  $v(t)$  for  $t \geq 0$ .

Examples 8.2 and 8.3 illustrate how to find the overdamped response of a parallel  $RLC$  circuit.

◀ **Voltage natural response—overdamped parallel  $RLC$  circuit**

**Example 8.2** Finding the Overdamped Natural Response of a Parallel RLC Circuit

For the circuit in Fig. 8.6,  $v(0^+) = 12$  V, and  $i_L(0^+) = 30$  mA.

- Find the initial current in each branch of the circuit.
- Find the initial value of  $dv/dt$ .
- Find the expression for  $v(t)$ .
- Sketch  $v(t)$  in the interval  $0 \leq t \leq 250$  ms.

**Solution**

- The inductor prevents an instantaneous change in its current, so the initial value of the inductor current is 30 mA:

$$i_L(0^-) = i_L(0) = i_L(0^+) = 30 \text{ mA.}$$

The capacitor holds the initial voltage across the parallel elements to 12 V. Thus the initial current in the resistive branch,  $i_R(0^+)$ , is  $12/200$ , or 60 mA. Kirchhoff's current law requires the sum of the currents leaving the top node to equal zero at every instant. Hence

$$\begin{aligned} i_C(0^+) &= -i_L(0^+) - i_R(0^+) \\ &= -90 \text{ mA.} \end{aligned}$$

Note that if we assumed the inductor current and capacitor voltage had reached their dc values at the instant that energy begins to be released,  $i_C(0^-) = 0$ . In other words, there is an instantaneous change in the capacitor current at  $t = 0$ .

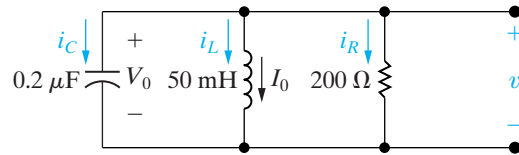
- Because  $i_C = C(dv/dt)$ ,

$$\frac{dv(0^+)}{dt} = \frac{-90 \times 10^{-3}}{0.2 \times 10^{-6}} = -450 \text{ kV/s.}$$

- The roots of the characteristic equation come from the values of  $R$ ,  $L$ , and  $C$ . For the values specified and from Eqs. 8.14 and 8.15 along with 8.16 and 8.17,

$$\begin{aligned} s_1 &= -1.25 \times 10^4 + \sqrt{1.5625 \times 10^8 - 10^8} \\ &= -12,500 + 7500 = -5000 \text{ rad/s,} \end{aligned}$$

$$\begin{aligned} s_2 &= -1.25 \times 10^4 - 2 \sqrt{1.5625 \times 10^8 - 10^8} \\ &= -12,500 - 7500 = -20,000 \text{ rad/s.} \end{aligned}$$



**Figure 8.6** ▲ The circuit for Example 8.2.

Because the roots are real and distinct, we know that the response is overdamped and hence has the form of Eq. 8.18. We find the co-efficients  $A_1$  and  $A_2$  from Eqs. 8.23 and 8.24. We've already determined  $s_1$ ,  $s_2$ ,  $v(0^+)$ , and  $dv(0^+)/dt$ , so

$$12 = A_1 + A_2,$$

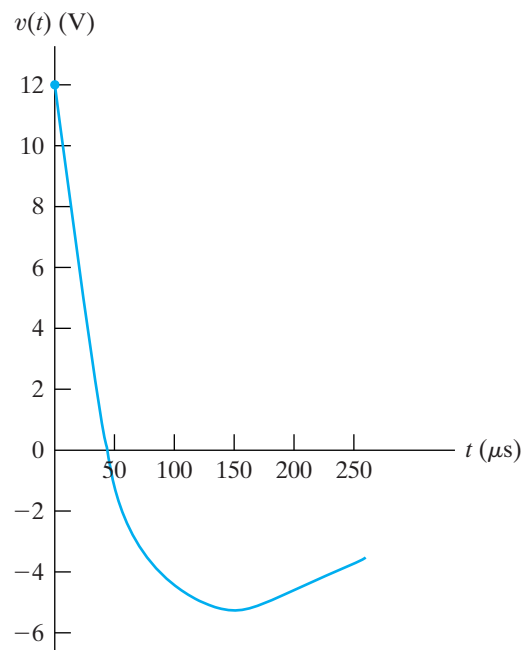
$$-450 \times 10^3 = -5000A_1 - 20,000A_2.$$

We solve two equations for  $A_1$  and  $A_2$  to obtain  $A_1 = -14$  V and  $A_2 = 26$  V. Substituting these values into Eq. 8.18 yields the overdamped voltage response:

$$v(t) = (-14e^{-5000t} + 26e^{-20,000t}) \text{ V, } t \geq 0.$$

As a check on these calculations, we note that the solution yields  $v(0) = 12$  V and  $dv(0^+)/dt = -450,000$  V/s.

- Figure 8.7 shows a plot of  $v(t)$  versus  $t$  over the interval  $0 \leq t \leq 250$  ms.



**Figure 8.7** ▲ The voltage response for Example 8.2.

**Example 8.3** Calculating Branch Currents in the Natural Response of a Parallel RLC Circuit

Derive the expressions that describe the three branch currents  $i_R$ ,  $i_L$ , and  $i_C$  in Example 8.2 (Fig. 8.6) during the time the stored energy is being released.

**Solution**

We know the voltage across the three branches from the solution in Example 8.2, namely,

$$v(t) = (-14e^{-5000t} + 26e^{-20,000t}) \text{ V}, \quad t \geq 0.$$

The current in the resistive branch is then

$$i_R(t) = \frac{v(t)}{200} = (-70e^{-5000t} + 130e^{-20,000t}) \text{ mA}, \quad t \geq 0.$$

There are two ways to find the current in the inductive branch. One way is to use the integral relationship that exists between the current and the voltage at the terminals of an inductor:

$$i_L(t) = \frac{1}{L} \int_0^t v_L(x) dx + I_0.$$

A second approach is to find the current in the capacitive branch first and then use the fact that  $i_R + i_L + i_C = 0$ . Let's use this approach. The current in the capacitive branch is

$$\begin{aligned} i_C(t) &= C \frac{dv}{dt} \\ &= 0.2 \times 10^{-6} (70,000e^{-5000t} - 520,000e^{-20,000t}) \\ &= (14e^{-5000t} - 104e^{-20,000t}) \text{ mA}, \quad t \geq 0^+. \end{aligned}$$

Note that  $i_C(0^+) = -90$  mA, which agrees with the result in Example 8.2.

Now we obtain the inductive branch current from the relationship

$$\begin{aligned} i_L(t) &= -i_R(t) - i_C(t) \\ &= (56e^{-5000t} - 26e^{-20,000t}) \text{ mA}, \quad t \geq 0. \end{aligned}$$

We leave it to you, in Assessment Problem 8.2, to show that the integral relation alluded to leads to the same result. Note that the expression for  $i_L$  agrees with the initial inductor current, as it must.

**ASSESSMENT PROBLEMS**

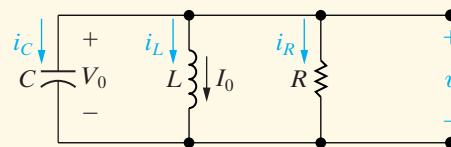
**Objective 1**—Be able to determine the natural response and the step response of parallel RLC circuits

**8.2** Use the integral relationship between  $i_L$  and  $v$  to find the expression for  $i_L$  in Fig. 8.6.

**Answer:**  $i_L(t) = (56e^{-5000t} - 26e^{-20,000t}) \text{ mA}, t \geq 0.$

**8.3** The element values in the circuit shown are  $R = 2 \text{ k}\Omega$ ,  $L = 250 \text{ mH}$ , and  $C = 10 \text{ nF}$ . The initial current  $I_0$  in the inductor is  $-4 \text{ A}$ , and the initial voltage on the capacitor is  $0 \text{ V}$ . The output signal is the voltage  $v$ . Find (a)  $i_R(0^+)$ ; (b)  $i_C(0^+)$ ; (c)  $dv(0^+)/dt$ ; (d)  $A_1$ ; (e)  $A_2$ ; and (f)  $v(t)$  when  $t \geq 0$ .

**NOTE:** Also try Chapter Problems 8.5 and 8.13.



**Answer:** (a) 0; (b) 4 A; (c)  $4 \times 10^8 \text{ V/s}$ ; (d) 13,333 V; (e)  $-13,333 \text{ V}$ ; (f)  $13,333(e^{-10,000t} - e^{-40,000t}) \text{ V}.$

## The Underdamped Voltage Response

When  $\omega_0^2 > \alpha^2$ , the roots of the characteristic equation are complex, and the response is underdamped. For convenience, we express the roots  $s_1$  and  $s_2$  as

$$\begin{aligned} s_1 &= -\alpha + \sqrt{-(\omega_0^2 - \alpha^2)} \\ &= -\alpha + j\sqrt{\omega_0^2 - \alpha^2} \\ &= -\alpha + j\omega_d \end{aligned} \quad (8.25)$$

$$s_2 = -\alpha - j\omega_d, \quad (8.26)$$

where

**Damped radian frequency** ▶

$$\omega_d = \sqrt{\omega_0^2 - \alpha^2}. \quad (8.27)$$

The term  $\omega_d$  is called the **damped radian frequency**. We explain later the reason for this terminology.

The underdamped voltage response of a parallel RLC circuit is

**Voltage natural response—underdamped parallel RLC circuits** ▶

$$v(t) = B_1 e^{-\alpha t} \cos \omega_d t + B_2 e^{-\alpha t} \sin \omega_d t, \quad (8.28)$$

which follows from Eq. 8.18. In making the transition from Eq. 8.18 to Eq. 8.28, we use the Euler identity:

$$e^{\pm j\theta} = \cos \theta \pm j \sin \theta. \quad (8.29)$$

Thus,

$$\begin{aligned} v(t) &= A_1 e^{(-\alpha + j\omega_d)t} + A_2 e^{-(\alpha + j\omega_d)t} \\ &= A_1 e^{-\alpha t} e^{j\omega_d t} + A_2 e^{-\alpha t} e^{-j\omega_d t} \\ &= e^{-\alpha t} (A_1 \cos \omega_d t + jA_1 \sin \omega_d t + A_2 \cos \omega_d t - jA_2 \sin \omega_d t) \\ &= e^{-\alpha t} [(A_1 + A_2) \cos \omega_d t + j(A_1 - A_2) \sin \omega_d t]. \end{aligned}$$

At this point in the transition from Eq. 8.18 to 8.28, replace the arbitrary constants  $A_1 + A_2$  and  $j(A_1 - A_2)$  with new arbitrary constants denoted  $B_1$  and  $B_2$  to get

$$\begin{aligned} v &= e^{-\alpha t} (B_1 \cos \omega_d t + B_2 \sin \omega_d t) \\ &= B_1 e^{-\alpha t} \cos \omega_d t + B_2 e^{-\alpha t} \sin \omega_d t. \end{aligned}$$

The constants  $B_1$  and  $B_2$  are real, not complex, because the voltage is a real function. Don't be misled by the fact that  $B_2 = j(A_1 - A_2)$ . In this underdamped case,  $A_1$  and  $A_2$  are complex conjugates, and thus  $B_1$  and  $B_2$  are real. (See Problems 8.12 and 8.13.) The reason for defining the underdamped response in terms of the coefficients  $B_1$  and  $B_2$  is that it yields a



simpler expression for the voltage,  $v$ . We determine  $B_1$  and  $B_2$  by the initial energy stored in the circuit, in the same way that we found  $A_1$  and  $A_2$  for the overdamped response: by evaluating  $v$  at  $t = 0^+$  and its derivative at  $t = 0^+$ . As with  $s_1$  and  $s_2$ ,  $\alpha$  and  $\omega_d$  are fixed by the circuit parameters  $R$ ,  $L$ , and  $C$ .

For the underdamped response, the two simultaneous equations that determine  $B_1$  and  $B_2$  are

$$v(0^+) = V_0 = B_1, \quad (8.30)$$

$$\frac{dv(0^+)}{dt} = \frac{i_c(0^+)}{C} = -\alpha B_1 + \omega_d B_2. \quad (8.31)$$

Let's look at the general nature of the underdamped response. First, the trigonometric functions indicate that this response is oscillatory; that is, the voltage alternates between positive and negative values. The rate at which the voltage oscillates is fixed by  $\omega_d$ . Second, the amplitude of the oscillation decreases exponentially. The rate at which the amplitude falls off is determined by  $\alpha$ . Because  $\alpha$  determines how quickly the oscillations subside, it is also referred to as the **damping factor** or **damping coefficient**. That explains why  $\omega_d$  is called the damped radian frequency. If there is no damping,  $\alpha = 0$  and the frequency of oscillation is  $\omega_0$ . Whenever there is a dissipative element,  $R$ , in the circuit,  $\alpha$  is not zero and the frequency of oscillation,  $\omega_d$ , is less than  $\omega_0$ . Thus when  $\alpha$  is not zero, the frequency of oscillation is said to be damped.

The oscillatory behavior is possible because of the two types of energy-storage elements in the circuit: the inductor and the capacitor. (A mechanical analogy of this electric circuit is that of a mass suspended on a spring, where oscillation is possible because energy can be stored in both the spring and the moving mass.) We say more about the characteristics of the underdamped response following Example 8.4, which examines a circuit whose response is underdamped. In summary, note that the overall process for finding the underdamped response is the same as that for the overdamped response, although the response equations and the simultaneous equations used to find the constants are slightly different.

### Example 8.4 Finding the Underdamped Natural Response of a Parallel RLC Circuit

In the circuit shown in Fig. 8.8,  $V_0 = 0$ , and  $I_0 = -12.25$  mA.

- Calculate the roots of the characteristic equation.
- Calculate  $v$  and  $dv/dt$  at  $t = 0^+$ .
- Calculate the voltage response for  $t \geq 0$ .
- Plot  $v(t)$  versus  $t$  for the time interval  $0 \leq t \leq 11$  ms.

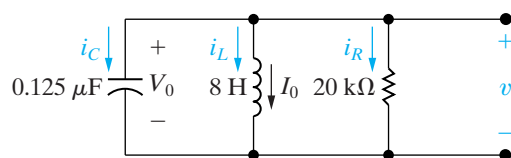


Figure 8.8 ▲ The circuit for Example 8.4.

### Solution

a) Because

$$\alpha = \frac{1}{2RC} = \frac{10^6}{2(20)10^3(0.125)} = 200 \text{ rad/s,}$$

$$\omega_0 = \frac{1}{\sqrt{LC}} = \sqrt{\frac{10^6}{(8)(0.125)}} = 10^3 \text{ rad/s,}$$

we have

$$\omega_0^2 > \alpha^2.$$

Therefore, the response is underdamped. Now,

$$\begin{aligned}\omega_d &= \sqrt{\omega_0^2 - \alpha^2} = \sqrt{10^6 - 4 \times 10^4} = 100\sqrt{96} \\ &= 979.80 \text{ rad/s},\end{aligned}$$

$$s_1 = -\alpha + j\omega_d = -200 + j979.80 \text{ rad/s},$$

$$s_2 = -\alpha - j\omega_d = -200 - j979.80 \text{ rad/s}.$$

For the underdamped case, we do not ordinarily solve for  $s_1$  and  $s_2$  because we do not use them explicitly. However, this example emphasizes why  $s_1$  and  $s_2$  are known as complex frequencies.

b) Because  $v$  is the voltage across the terminals of a capacitor, we have

$$v(0) = v(0^+) = V_0 = 0.$$

Because  $v(0^+) = 0$ , the current in the resistive branch is zero at  $t = 0^+$ . Hence the current in the capacitor at  $t = 0^+$  is the negative of the inductor current:

$$i_C(0^+) = -(-12.25) = 12.25 \text{ mA}.$$

Therefore the initial value of the derivative is

$$\frac{dv(0^+)}{dt} = \frac{(12.25)(10^{-3})}{(0.125)(10^{-6})} = 98,000 \text{ V/s}.$$

c) From Eqs. 8.30 and 8.31,  $B_1 = 0$  and

$$B_2 = \frac{98,000}{\omega_d} \approx 100 \text{ V}.$$

Substituting the numerical values of  $\alpha$ ,  $\omega_d$ ,  $B_1$ , and  $B_2$  into the expression for  $v(t)$  gives

$$v(t) = 100e^{-200t} \sin 979.80t \text{ V}, \quad t \geq 0.$$

d) Figure 8.9 shows the plot of  $v(t)$  versus  $t$  for the first 11 ms after the stored energy is released. It clearly indicates the damped oscillatory nature of the underdamped response. The voltage  $v(t)$  approaches its final value, alternating between values that are greater than and less than the final value. Furthermore, these swings about the final value decrease exponentially with time.

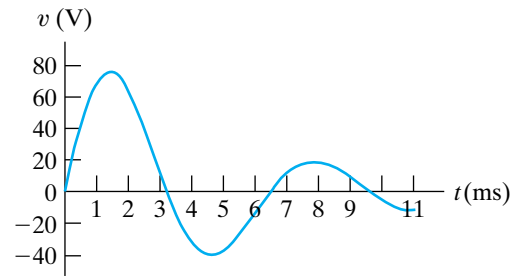


Figure 8.9 ▲ The voltage response for Example 8.4.

## Characteristics of the Underdamped Response

The underdamped response has several important characteristics. First, as the dissipative losses in the circuit decrease, the persistence of the oscillations increases, and the frequency of the oscillations approaches  $\omega_0$ . In other words, as  $R \rightarrow \infty$ , the dissipation in the circuit in Fig. 8.8 approaches zero because  $p = v^2/R$ . As  $R \rightarrow \infty$ ,  $\alpha \rightarrow 0$ , which tells us that  $\omega_d \rightarrow \omega_0$ . When  $\alpha = 0$ , the maximum amplitude of the voltage remains constant; thus the oscillation at  $\omega_0$  is sustained. In Example 8.4, if  $R$  were increased to infinity, the solution for  $v(t)$  would become

$$v(t) = 98 \sin 1000t \text{ V}, \quad t \geq 0.$$

Thus, in this case the oscillation is sustained, the maximum amplitude of the voltage is 98 V, and the frequency of oscillation is 1000 rad/s.

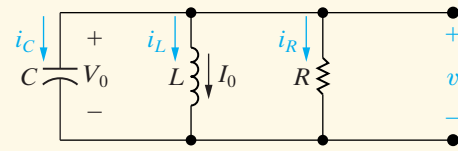
We may now describe qualitatively the difference between an underdamped and an overdamped response. In an underdamped system, the response oscillates, or “bounces,” about its final value. This oscillation is also referred to as *ringing*. In an overdamped system, the response approaches its final value without ringing or in what is sometimes described as a “sluggish” manner. When specifying the desired response of a second order system, you may want to reach the final value in the shortest time possible, and you may not be concerned with small oscillations about that final value. If so, you would design the system components to achieve an underdamped response. On the other hand, you may be concerned that the response not exceed its final value, perhaps to ensure that components are not damaged. In such a case, you would design the system components to achieve an overdamped response, and you would have to accept a relatively slow rise to the final value.

### ASSESSMENT PROBLEM

**Objective 1**—Be able to determine the natural and the step response of parallel RLC circuits

**8.4** A 10 mH inductor, a 1  $\mu\text{F}$  capacitor, and a variable resistor are connected in parallel in the circuit shown. The resistor is adjusted so that the roots of the characteristic equation are  $-8000 \pm j6000$  rad/s. The initial voltage on the capacitor is 10 V, and the initial current in the inductor is 80 mA. Find

- $R$ ;
- $dv(0^+)/dt$ ;
- $B_1$  and  $B_2$  in the solution for  $v$ ; and
- $i_L(t)$ .



- Answer:**
- 62.5  $\Omega$ ;
  - 240,000 V/s;
  - $B_1 = 10$  V,  $B_2 = -80/3$  V;
  - $i_L(t) = 10e^{-8000t}[8 \cos 6000t + (82/3) \sin 6000t]$  mA when  $t \geq 0$ .

*NOTE:* Also try Chapter Problems 8.6 and 8.11.

## The Critically Damped Voltage Response

The second-order circuit in Fig. 8.8 is critically damped when  $\omega_0^2 = \alpha^2$ , or  $\omega_0 = \alpha$ . When a circuit is critically damped, the response is on the verge of oscillating. In addition, the two roots of the characteristic equation are real and equal; that is,

$$s_1 = s_2 = -\alpha = -\frac{1}{2RC}. \quad (8.32)$$

When this occurs, the solution for the voltage no longer takes the form of Eq. 8.18. This equation breaks down because if  $s_1 = s_2 = -\alpha$ , it predicts that

$$v = (A_1 + A_2)e^{-\alpha t} = A_0e^{-\alpha t}, \quad (8.33)$$

where  $A_0$  is an arbitrary constant. Equation 8.33 cannot satisfy two independent initial conditions ( $V_0, I_0$ ) with only one arbitrary constant,  $A_0$ . Recall that the circuit parameters  $R$  and  $C$  fix  $\alpha$ .

We can trace this dilemma back to the assumption that the solution takes the form of Eq. 8.18. When the roots of the characteristic equation are equal, the solution for the differential equation takes a different form, namely

$$v(t) = D_1te^{-\alpha t} + D_2e^{-\alpha t}. \quad (8.34)$$

◀ **Voltage natural response—critically damped parallel RLC circuit**

Thus in the case of a repeated root, the solution involves a simple exponential term plus the product of a linear and an exponential term. The justification of Eq. 8.34 is left for an introductory course in differential equations. Finding the solution involves obtaining  $D_1$  and  $D_2$  by following the same pattern set in the overdamped and underdamped cases: We use the initial values of the voltage and the derivative of the voltage with respect to time to write two equations containing  $D_1$  and/or  $D_2$ .

From Eq. 8.34, the two simultaneous equations needed to determine  $D_1$  and  $D_2$  are

$$v(0^+) = V_0 = D_2, \quad (8.35)$$

$$\frac{dv(0^+)}{dt} = \frac{i_C(0^+)}{C} = D_1 - \alpha D_2. \quad (8.36)$$

As we can see, in the case of a critically damped response, both the equation for  $v(t)$  and the simultaneous equations for the constants  $D_1$  and  $D_2$  differ from those for over- and underdamped responses, but the general approach is the same. You will rarely encounter critically damped systems in practice, largely because  $\omega_0$  must equal  $\alpha$  exactly. Both of these quantities depend on circuit parameters, and in a real circuit it is very difficult to choose component values that satisfy an exact equality relationship.

Example 8.5 illustrates the approach for finding the critically damped response of a parallel RLC circuit.

### Example 8.5 Finding the Critically Damped Natural Response of a Parallel RLC Circuit

- For the circuit in Example 8.4 (Fig. 8.8), find the value of  $R$  that results in a critically damped voltage response.
- Calculate  $v(t)$  for  $t \geq 0$ .
- Plot  $v(t)$  versus  $t$  for  $0 \leq t \leq 7$  ms.

#### Solution

- From Example 8.4, we know that  $\omega_0^2 = 10^6$ . Therefore for critical damping,

$$\alpha = 10^3 = \frac{1}{2RC},$$

or

$$R = \frac{10^6}{(2000)(0.125)} = 4000 \, \Omega.$$

- From the solution of Example 8.4, we know that  $v(0^+) = 0$  and  $dv(0^+)/dt = 98,000$  V/s. From Eqs. 8.35 and 8.36,  $D_2 = 0$  and  $D_1 = 98,000$  V/s.

Substituting these values for  $\alpha$ ,  $D_1$ , and  $D_2$  into Eq. 8.34 gives

$$v(t) = 98,000te^{-1000t} \text{ V}, \quad t \geq 0.$$

- Figure 8.10 shows a plot of  $v(t)$  versus  $t$  in the interval  $0 \leq t \leq 7$  ms.

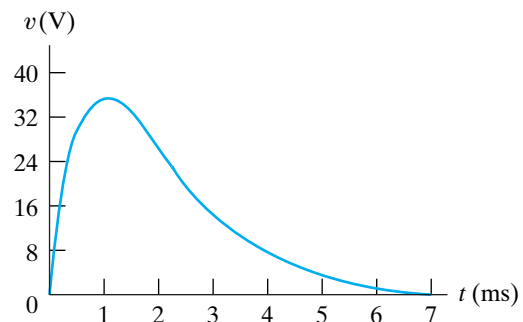


Figure 8.10 ▲ The voltage response for Example 8.5.

## ASSESSMENT PROBLEM

**Objective 1**—Be able to determine the natural and the step response of parallel RLC circuits

- 8.5** The resistor in the circuit in Assessment Problem 8.4 is adjusted for critical damping. The inductance and capacitance values are 0.4 H and 10  $\mu\text{F}$ , respectively. The initial energy stored in the circuit is 25 mJ and is distributed equally between the inductor and capacitor. Find (a)  $R$ ; (b)  $V_0$ ; (c)  $I_0$ ; (d)  $D_1$  and  $D_2$  in the solution for  $v$ ; and (e)  $i_R$ ,  $t \geq 0^+$ .

- Answer:** (a) 100  $\Omega$ ;  
 (b) 50 V;  
 (c) 250 mA;  
 (d)  $-50,000$  V/s, 50 V;  
 (e)  $i_R(t) = (-500te^{-500t} + 0.50e^{-500t})$  A,  
 $t \geq 0^+$ .

*NOTE:* Also try Chapter Problems 8.7 and 8.12.

## A Summary of the Results

We conclude our discussion of the parallel  $RLC$  circuit's natural response with a brief summary of the results. The first step in finding the natural response is to calculate the roots of the characteristic equation. You then know immediately whether the response is overdamped, underdamped, or critically damped.

If the roots are real and distinct ( $\omega_0^2 < \alpha^2$ ), the response is overdamped and the voltage is

$$v(t) = A_1 e^{s_1 t} + A_2 e^{s_2 t},$$

where

$$s_1 = -\alpha + \sqrt{\alpha^2 - \omega_0^2},$$

$$s_2 = -\alpha - \sqrt{\alpha^2 - \omega_0^2},$$

$$\alpha = \frac{1}{2RC},$$

$$\omega_0^2 = \frac{1}{LC}.$$

The values of  $A_1$  and  $A_2$  are determined by solving the following simultaneous equations:

$$\begin{aligned} v(0^+) &= A_1 + A_2, \\ \frac{dv(0^+)}{dt} &= \frac{i_C(0^+)}{C} = s_1 A_1 + s_2 A_2. \end{aligned}$$

If the roots are complex  $\omega_0^2 > \alpha^2$  the response is underdamped and the voltage is

$$v(t) = B_1 e^{-\alpha t} \cos \omega_d t + B_2 e^{-\alpha t} \sin \omega_d t,$$

where

$$\omega_d = \sqrt{\omega_0^2 - \alpha^2}.$$

The values of  $B_1$  and  $B_2$  are found by solving the following simultaneous equations:

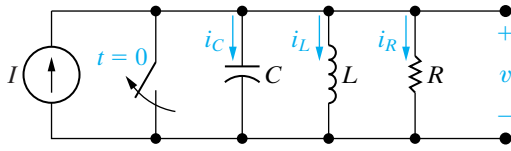
$$\begin{aligned} v(0^+) &= V_0 = B_1, \\ \frac{dv(0^+)}{dt} &= \frac{i_C(0^+)}{C} = -\alpha B_1 + \omega_d B_2. \end{aligned}$$

If the roots of the characteristic equation are real and equal ( $\omega_0^2 = \alpha^2$ ), the voltage response is

$$v(t) = D_1 t e^{-\alpha t} + D_2 e^{-\alpha t},$$

where  $\alpha$  is as in the other solution forms. To determine values for the constants  $D_1$  and  $D_2$ , solve the following simultaneous equations:

$$\begin{aligned} v(0^+) &= V_0 = D_2, \\ \frac{dv(0^+)}{dt} &= \frac{i_C(0^+)}{C} = D_1 - \alpha D_2. \end{aligned}$$



**Figure 8.11** ▲ A circuit used to describe the step response of a parallel *RLC* circuit.

## 8.3 The Step Response of a Parallel *RLC* Circuit

Finding the step response of a parallel *RLC* circuit involves finding the voltage across the parallel branches or the current in the individual branches as a result of the sudden application of a dc current source. There may or may not be energy stored in the circuit when the current source is applied. The task is represented by the circuit shown in Fig. 8.11. To develop a general approach to finding the step response of a second-order circuit, we focus on finding the current in the inductive branch ( $i_L$ ). This current is of particular interest because it does not approach zero as  $t$  increases. Rather, after the switch has been open for a long time, the inductor current equals the dc source current  $I$ . Because we want to focus on the technique for finding the step response, we assume that the initial energy stored in the circuit is zero. This assumption simplifies the calculations and doesn't alter the basic process involved. In Example 8.10 we will see how the presence of initially stored energy enters into the general procedure.

To find the inductor current  $i_L$ , we must solve a second-order differential equation equated to the forcing function  $I$ , which we derive as follows. From Kirchhoff's current law, we have

$$i_L + i_R + i_C = I,$$

or

$$i_L + \frac{v}{R} + C \frac{dv}{dt} = I. \quad (8.37)$$

Because

$$v = L \frac{di_L}{dt}, \quad (8.38)$$

we get

$$\frac{dv}{dt} = L \frac{d^2 i_L}{dt^2}. \quad (8.39)$$

Substituting Eqs. 8.38 and 8.39 into Eq. 8.37 gives

$$i_L + \frac{L}{R} \frac{di_L}{dt} + LC \frac{d^2 i_L}{dt^2} = I. \quad (8.40)$$

For convenience, we divide through by  $LC$  and rearrange terms:

$$\frac{d^2 i_L}{dt^2} + \frac{1}{RC} \frac{di_L}{dt} + \frac{i_L}{LC} = \frac{I}{LC}. \quad (8.41)$$

Comparing Eq. 8.41 with Eq. 8.3 reveals that the presence of a nonzero term on the right-hand side of the equation alters the task. Before showing how to solve Eq. 8.41 directly, we obtain the solution indirectly. When we know the solution of Eq. 8.41, explaining the direct approach will be easier.

## The Indirect Approach

We can solve for  $i_L$  indirectly by first finding the voltage  $v$ . We do this with the techniques introduced in Section 8.2, because the differential equation that  $v$  must satisfy is identical to Eq. 8.3. To see this, we simply return to Eq. 8.37 and express  $i_L$  as a function of  $v$ ; thus

$$\frac{1}{L} \int_0^t v d\tau + \frac{v}{R} + C \frac{dv}{dt} = I. \quad (8.42)$$

Differentiating Eq. 8.42 once with respect to  $t$  reduces the right-hand side to zero because  $I$  is a constant. Thus

$$\frac{v}{L} + \frac{1}{R} \frac{dv}{dt} + C \frac{d^2v}{dt^2} = 0,$$

or

$$\frac{d^2v}{dt^2} + \frac{1}{RC} \frac{dv}{dt} + \frac{v}{LC} = 0. \quad (8.43)$$

As discussed in Section 8.2, the solution for  $v$  depends on the roots of the characteristic equation. Thus the three possible solutions are

$$v = A_1 e^{s_1 t} + A_2 e^{s_2 t}, \quad (8.44)$$

$$v = B_1 e^{-\alpha t} \cos \omega_d t + B_2 e^{-\alpha t} \sin \omega_d t, \quad (8.45)$$

$$v = D_1 t e^{-\alpha t} + D_2 e^{-\alpha t}. \quad (8.46)$$

A word of caution: Because there is a source in the circuit for  $t > 0$ , you must take into account the value of the source current at  $t = 0^+$  when you evaluate the coefficients in Eqs. 8.44–8.46.

To find the three possible solutions for  $i_L$ , we substitute Eqs. 8.44–8.46 into Eq. 8.37. You should be able to verify, when this has been done, that the three solutions for  $i_L$  will be

$$i_L = I + A'_1 e^{s_1 t} + A'_2 e^{s_2 t}, \quad (8.47)$$

$$i_L = I + B'_1 e^{-\alpha t} \cos \omega_d t + B'_2 e^{-\alpha t} \sin \omega_d t, \quad (8.48)$$

$$i_L = I + D'_1 t e^{-\alpha t} + D'_2 e^{-\alpha t}, \quad (8.49)$$

where  $A'_1$ ,  $A'_2$ ,  $B'_1$ ,  $B'_2$ ,  $D'_1$ , and  $D'_2$ , are arbitrary constants.

In each case, the primed constants can be found indirectly in terms of the arbitrary constants associated with the voltage solution. However, this approach is cumbersome.

## The Direct Approach

It is much easier to find the primed constants directly in terms of the initial values of the response function. For the circuit being discussed, we would find the primed constants from  $i_L(0)$  and  $di_L(0)/dt$ .

The solution for a second-order differential equation with a constant forcing function equals the forced response plus a response function



identical in form to the natural response. Thus we can always write the solution for the step response in the form

$$i = I_f + \left\{ \begin{array}{l} \text{function of the same form} \\ \text{as the natural response} \end{array} \right\}, \quad (8.50)$$

or

$$v = V_f + \left\{ \begin{array}{l} \text{function of the same form} \\ \text{as the natural response} \end{array} \right\}, \quad (8.51)$$

where  $I_f$  and  $V_f$  represent the final value of the response function. The final value may be zero, as was, for example, the case with the voltage  $v$  in the circuit in Fig. 8.8.

Examples 8.6–8.10 illustrate the technique of finding the step response of a parallel RLC circuit using the direct approach.

### Example 8.6 Finding the Overdamped Step Response of a Parallel RLC Circuit

The initial energy stored in the circuit in Fig. 8.12 is zero. At  $t = 0$ , a dc current source of 24 mA is applied to the circuit. The value of the resistor is  $400 \Omega$ .

- What is the initial value of  $i_L$ ?
- What is the initial value of  $di_L/dt$ ?
- What are the roots of the characteristic equation?
- What is the numerical expression for  $i_L(t)$  when  $t \geq 0$ ?

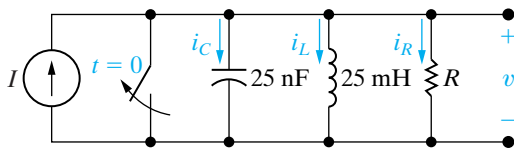


Figure 8.12 ▲ The circuit for Example 8.6.

#### Solution

- No energy is stored in the circuit prior to the application of the dc current source, so the initial current in the inductor is zero. The inductor prohibits an instantaneous change in inductor current; therefore  $i_L(0) = 0$  immediately after the switch has been opened.
- The initial voltage on the capacitor is zero before the switch has been opened; therefore it will be zero immediately after. Now, because  $v = L di_L/dt$ ,

$$\frac{di_L}{dt}(0^+) = 0.$$

- From the circuit elements, we obtain

$$\omega_0^2 = \frac{1}{LC} = \frac{10^{12}}{(25)(25)} = 16 \times 10^8,$$

$$\alpha = \frac{1}{2RC} = \frac{10^9}{(2)(400)(25)} = 5 \times 10^4 \text{ rad/s},$$

or

$$\alpha^2 = 25 \times 10^8.$$

Because  $\omega_0^2 < \alpha^2$ , the roots of the characteristic equation are real and distinct. Thus

$$s_1 = -5 \times 10^4 + 3 \times 10^4 = -20,000 \text{ rad/s},$$

$$s_2 = -5 \times 10^4 - 3 \times 10^4 = -80,000 \text{ rad/s}.$$

- Because the roots of the characteristic equation are real and distinct, the inductor current response will be overdamped. Thus  $i_L(t)$  takes the form of Eq. 8.47, namely,

$$i_L = I_f + A_1' e^{s_1 t} + A_2' e^{s_2 t}.$$

#### ► Inductor current in overdamped parallel RLC circuit step response

Hence, from this solution, the two simultaneous equations that determine  $A_1'$  and  $A_2'$  are

$$i_L(0) = I_f + A_1' + A_2' = 0,$$

$$\frac{di_L}{dt}(0) = s_1 A_1' + s_2 A_2' = 0.$$

Solving for  $A_1'$  and  $A_2'$  gives

$$A_1' = -32 \text{ mA} \quad \text{and} \quad A_2' = 8 \text{ mA}.$$

The numerical solution for  $i_L(t)$  is

$$i_L(t) = (24 - 32e^{-20,000t} + 8e^{-80,000t}) \text{ mA}, \quad t \geq 0.$$

**Example 8.7** Finding the Underdamped Step Response of a Parallel RLC Circuit

The resistor in the circuit in Example 8.6 (Fig. 8.12) is increased to  $625 \Omega$ . Find  $i_L(t)$  for  $t \geq 0$ .

**Solution**

Because  $L$  and  $C$  remain fixed,  $\omega_0^2$  has the same value as in Example 8.6; that is,  $\omega_0^2 = 16 \times 10^8$ . Increasing  $R$  to  $625 \Omega$  decreases  $\alpha$  to  $3.2 \times 10^4$  rad/s. With  $\omega_0^2 > \alpha^2$ , the roots of the characteristic equation are complex. Hence

$$s_1 = -3.2 \times 10^4 + j2.4 \times 10^4 \text{ rad/s,}$$

$$s_2 = -3.2 \times 10^4 - j2.4 \times 10^4 \text{ rad/s.}$$

The current response is now underdamped and given by Eq. 8.48:

$$i_L(t) = I_f + B'_1 e^{-\alpha t} \cos \omega_d t + B'_2 e^{-\alpha t} \sin \omega_d t.$$

► Inductor current in underdamped parallel RLC circuit step response

Here,  $\alpha$  is 32,000 rad/s,  $\omega_d$  is 24,000 rad/s, and  $I_f$  is 24 mA.

As in Example 8.6,  $B'_1$  and  $B'_2$  are determined from the initial conditions. Thus the two simultaneous equations are

$$i_L(0) = I_f + B'_1 = 0,$$

$$\frac{di_L}{dt}(0) = \omega_d B'_2 - \alpha B'_1 = 0.$$

Then,

$$B'_1 = -24 \text{ mA}$$

and

$$B'_2 = -32 \text{ mA.}$$

The numerical solution for  $i_L(t)$  is

$$i_L(t) = (24 - 24e^{-32,000t} \cos 24,000t - 32e^{-32,000t} \sin 24,000t) \text{ mA, } t \geq 0.$$

**Example 8.8** Finding the Critically Damped Step Response of a Parallel RLC Circuit

The resistor in the circuit in Example 8.6 (Fig. 8.12) is set at  $500 \Omega$ . Find  $i_L$  for  $t \geq 0$ .

**Solution**

We know that  $\omega_0^2$  remains at  $16 \times 10^8$ . With  $R$  set at  $500 \Omega$ ,  $\alpha$  becomes  $4 \times 10^4 \text{ s}^{-1}$ , which corresponds to critical damping. Therefore the solution for  $i_L(t)$  takes the form of Eq. 8.49:

$$i_L(t) = I_f + D'_1 t e^{-\alpha t} + D'_2 e^{-\alpha t}.$$

► Inductor current in critically damped parallel RLC circuit step response

Again,  $D'_1$  and  $D'_2$  are computed from initial conditions, or

$$i_L(0) = I_f + D'_2 = 0,$$

$$\frac{di_L}{dt}(0) = D'_1 - \alpha D'_2 = 0.$$

Thus

$$D'_1 = -960,000 \text{ mA/s and } D'_2 = -24 \text{ mA.}$$

The numerical expression for  $i_L(t)$  is

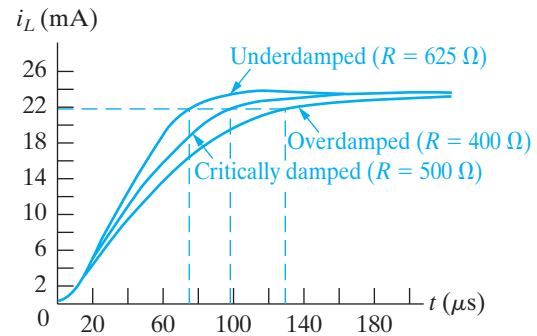
$$i_L(t) = (24 - 960,000t e^{-40,000t} - 24e^{-40,000t}) \text{ mA, } t \geq 0.$$

**Example 8.9** Comparing the Three-Step Response Forms

- Plot on a single graph, over a range from 0 to 220  $\mu\text{s}$ , the overdamped, underdamped, and critically damped responses derived in Examples 8.6–8.8.
- Use the plots of (a) to find the time required for  $i_L$  to reach 90% of its final value.
- On the basis of the results obtained in (b), which response would you specify in a design that puts a premium on reaching 90% of the final value of the output in the shortest time?
- Which response would you specify in a design that must ensure that the final value of the current is never exceeded?

**Solution**

- See Fig. 8.13.
- The final value of  $i_L$  is 24 mA, so we can read the times off the plots corresponding to  $i_L = 21.6$  mA. Thus  $t_{od} = 130 \mu\text{s}$ ,  $t_{cd} = 97 \mu\text{s}$ , and  $t_{ud} = 74 \mu\text{s}$ .
- The underdamped response reaches 90% of the final value in the fastest time, so it is the desired response type when speed is the most important design specification.

**Figure 8.13** ▲ The current plots for Example 8.9.

- From the plot, you can see that the underdamped response overshoots the final value of current, whereas neither the critically damped nor the overdamped response produces currents in excess of 24 mA. Although specifying either of the latter two responses would meet the design specification, it is best to use the overdamped response. It would be impractical to require a design to achieve the exact component values that ensure a critically damped response.

**Example 8.10** Finding Step Response of a Parallel RLC Circuit with Initial Stored Energy

Energy is stored in the circuit in Example 8.8 (Fig. 8.12, with  $R = 500 \Omega$ ) at the instant the dc current source is applied. The initial current in the inductor is 29 mA, and the initial voltage across the capacitor is 50 V. Find (a)  $i_L(0)$ ; (b)  $di_L(0)/dt$ ; (c)  $i_L(t)$  for  $t \geq 0$ ; (d)  $v(t)$  for  $t \geq 0$ .

**Solution**

- There cannot be an instantaneous change of current in an inductor, so the initial value of  $i_L$  in the first instant after the dc current source has been applied must be 29 mA.
- The capacitor holds the initial voltage across the inductor to 50 V. Therefore

$$L \frac{di_L}{dt}(0^+) = 50,$$

$$\frac{di_L}{dt}(0^+) = \frac{50}{25} \times 10^3 = 2000 \text{ A/s.}$$

- From the solution of Example 8.8, we know that the current response is critically damped. Thus

$$i_L(t) = I_f + D'_1 t e^{-\alpha t} + D'_2 e^{-\alpha t},$$

where

$$\alpha = \frac{1}{2RC} = 40,000 \text{ rad/s} \quad \text{and} \quad I_f = 24 \text{ mA.}$$

Notice that the effect of the nonzero initial stored energy is on the calculations for the constants  $D'_1$  and  $D'_2$ , which we obtain from the initial conditions. First we use the initial value of the inductor current:

$$i_L(0) = I_f + D'_2 = 29 \text{ mA,}$$

from which we get

$$D'_2 = 29 - 24 = 5 \text{ mA.}$$

The solution for  $D'_1$  is

$$\frac{di_L}{dt}(0^+) = D'_1 - \alpha D'_2 = 2000,$$

or

$$\begin{aligned} D'_1 &= 2000 + \alpha D'_2 \\ &= 2000 + (40,000)(5 \times 10^{-3}) \\ &= 2200 \text{ A/s} = 2.2 \times 10^6 \text{ mA/s}. \end{aligned}$$

Thus the numerical expression for  $i_L(t)$  is

$$\begin{aligned} i_L(t) &= (24 + 2.2 \times 10^6 t e^{-40,000t} \\ &\quad + 5e^{-40,000t}) \text{ mA}, \quad t \geq 0. \end{aligned}$$

d) We can get the expression for  $v(t)$ ,  $t \geq 0$  by using the relationship between the voltage and current in an inductor:

$$\begin{aligned} v(t) &= L \frac{di_L}{dt} \\ &= (25 \times 10^{-3})[(2.2 \times 10^6)(-40,000)t e^{-40,000t} \\ &\quad + 2.2 \times 10^6 e^{-40,000t} \\ &\quad + (5)(-40,000)e^{-40,000t}] \times 10^{-3} \\ &= -2.2 \times 10^6 t e^{-40,000t} + 50e^{-40,000t} \text{ V}, \quad t \geq 0. \end{aligned}$$

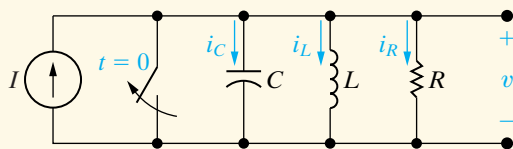
To check this result, let's verify that the initial voltage across the inductor is 50 V:

$$v(0) = -2.2 \times 10^6(0)(1) + 50(1) = 50 \text{ V}.$$

### ASSESSMENT PROBLEM

**Objective 1**—Be able to determine the natural response and the step response of parallel RLC circuits

**8.6** In the circuit shown,  $R = 500 \Omega$ ,  $L = 0.64 \text{ H}$ ,  $C = 1 \mu\text{F}$ , and  $I = -1 \text{ A}$ . The initial voltage drop across the capacitor is 40 V and the initial inductor current is 0.5 A. Find (a)  $i_R(0^+)$ ; (b)  $i_C(0^+)$ ; (c)  $di_L(0^+)/dt$ ; (d)  $s_1, s_2$ ; (e)  $i_L(t)$  for  $t \geq 0$ ; and (f)  $v(t)$  for  $t \geq 0^+$ .



*NOTE:* Also try Chapter Problems 8.27–8.29.

**Answer:** (a) 80 mA;  
 (b)  $-1.58 \text{ A}$ ;  
 (c)  $62.5 \text{ A/s}$ ;  
 (d)  $(-1000 + j750) \text{ rad/s}$ ,  
 $(-1000 - j750) \text{ rad/s}$ ;  
 (e)  $[-1 + e^{-1000t}[1.5 \cos 750t$   
 $+ 2.0833 \sin 750t]] \text{ A}$ , for  $t \geq 0$ ;  
 (f)  $e^{-1000t}(40 \cos 750t - 2053.33 \sin 750t) \text{ V}$ ,  
 for  $t \geq 0^+$ .

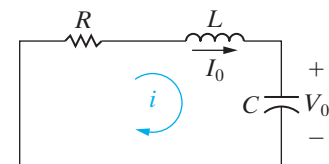
## 8.4 The Natural and Step Response of a Series RLC Circuit

The procedures for finding the natural or step responses of a series RLC circuit are the same as those used to find the natural or step responses of a parallel RLC circuit, because both circuits are described by differential equations that have the same form. We begin by summing the voltages around the closed path in the circuit shown in Fig. 8.14. Thus

$$Ri + L \frac{di}{dt} + \frac{1}{C} \int_0^t i d\tau + V_0 = 0. \quad (8.52)$$

We now differentiate Eq. 8.52 once with respect to  $t$  to get

$$R \frac{di}{dt} + L \frac{d^2i}{dt^2} + \frac{i}{C} = 0, \quad (8.53)$$



**Figure 8.14** ▲ A circuit used to illustrate the natural response of a series RLC circuit.

which we can rearrange as

$$\frac{d^2i}{dt^2} + \frac{R}{L} \frac{di}{dt} + \frac{i}{LC} = 0. \tag{8.54}$$

Comparing Eq. 8.54 with Eq. 8.3 reveals that they have the same form. Therefore, to find the solution of Eq. 8.54, we follow the same process that led us to the solution of Eq. 8.3.

From Eq. 8.54, the characteristic equation for the series RLC circuit is

**Characteristic equation—series RLC circuit ▶**

$$s^2 + \frac{R}{L}s + \frac{1}{LC} = 0. \tag{8.55}$$

The roots of the characteristic equation are

$$s_{1,2} = -\frac{R}{2L} \pm \sqrt{\left(\frac{R}{2L}\right)^2 - \frac{1}{LC}}, \tag{8.56}$$

or

$$s_{1,2} = -\alpha \pm \sqrt{\alpha^2 - \omega_0^2}. \tag{8.57}$$

The neper frequency ( $\alpha$ ) for the series RLC circuit is

**Neper frequency—series RLC circuit ▶**

$$\alpha = \frac{R}{2L} \text{ rad/s}, \tag{8.58}$$

and the expression for the resonant radian frequency is

**Resonant radian frequency—series RLC circuit ▶**

$$\omega_0 = \frac{1}{\sqrt{LC}} \text{ rad/s}. \tag{8.59}$$

Note that the equation for neper frequency of the series RLC circuit differs from that of the parallel RLC circuit, but the equations for resonant and damped radian frequencies are the same.

The current response will be overdamped, underdamped, or critically damped according to whether  $\omega_0^2 < \alpha^2$ ,  $\omega_0^2 > \alpha^2$ , or  $\omega_0^2 = \alpha^2$ , respectively. Thus the three possible solutions for the current are as follows:

**Current natural response forms in series RLC circuits F ▶**

$$i(t) = A_1e^{s_1t} + A_2e^{s_2t} \text{ (overdamped)}, \tag{8.60}$$

$$i(t) = B_1e^{-\alpha t} \cos \omega_d t + B_2e^{-\alpha t} \sin \omega_d t \text{ (underdamped)}, \tag{8.61}$$

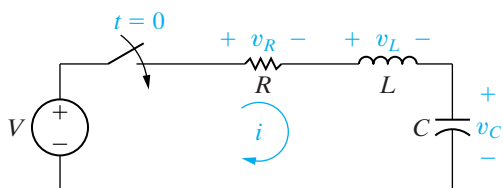
$$i(t) = D_1te^{-\alpha t} + D_2e^{-\alpha t} \text{ (critically damped)}. \tag{8.62}$$

When you have obtained the natural current response, you can find the natural voltage response across any circuit element.

To verify that the procedure for finding the step response of a series RLC circuit is the same as that for a parallel RLC circuit, we show that the differential equation that describes the capacitor voltage in Fig. 8.15 has the same form as the differential equation that describes the inductor current in Fig. 8.11. For convenience, we assume that zero energy is stored in the circuit at the instant the switch is closed.

Applying Kirchhoff's voltage law to the circuit shown in Fig. 8.15 gives

$$V = Ri + L \frac{di}{dt} + v_C. \tag{8.63}$$



**Figure 8.15** ▶ A circuit used to illustrate the step response of a series RLC circuit.

The current ( $i$ ) is related to the capacitor voltage ( $v_C$ ) by the expression

$$i = C \frac{dv_C}{dt}, \quad (8.64)$$

from which

$$\frac{di}{dt} = C \frac{d^2v_C}{dt^2}. \quad (8.65)$$

Substitute Eqs. 8.64 and 8.65 into Eq. 8.63 and write the resulting expression as

$$\frac{d^2v_C}{dt^2} + \frac{R}{L} \frac{dv_C}{dt} + \frac{v_C}{LC} = \frac{V}{LC}. \quad (8.66)$$

Equation 8.66 has the same form as Eq. 8.41; therefore the procedure for finding  $v_C$  parallels that for finding  $i_L$ . The three possible solutions for  $v_C$  are as follows:

$$v_C = V_f + A_1'e^{s_1t} + A_2'e^{s_2t} \text{ (overdamped),} \quad (8.67)$$

$$v_C = V_f + B_1'e^{-\alpha t} \cos \omega_d t + B_2'e^{-\alpha t} \sin \omega_d t \text{ (underdamped),} \quad (8.68)$$

$$v_C = V_f + D_1'te^{-\alpha t} + D_2'e^{-\alpha t} \text{ (critically damped),} \quad (8.69)$$

◀ Capacitor voltage step response forms in series RLC circuits

where  $V_f$  is the final value of  $v_C$ . Hence, from the circuit shown in Fig. 8.15, the final value of  $v_C$  is the dc source voltage  $V$ .

Example 8.11 and 8.12 illustrate the mechanics of finding the natural and step responses of a series RLC circuit.

### Example 8.11 Finding the Underdamped Natural Response of a Series RLC Circuit

The  $0.1 \mu\text{F}$  capacitor in the circuit shown in Fig. 8.16 is charged to 100 V. At  $t = 0$  the capacitor is discharged through a series combination of a 100 mH inductor and a  $560 \Omega$  resistor.

- Find  $i(t)$  for  $t \geq 0$ .
- Find  $v_C(t)$  for  $t \geq 0$ .

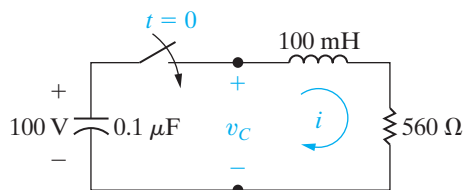


Figure 8.16 ▲ The circuit for Example 8.11.

### Solution

- The first step to finding  $i(t)$  is to calculate the roots of the characteristic equation. For the given element values,

$$\begin{aligned} \omega_0^2 &= \frac{1}{LC} \\ &= \frac{(10^3)(10^6)}{(100)(0.1)} = 10^8, \\ \alpha &= \frac{R}{2L} \\ &= \frac{560}{2(100)} \times 10^3 \\ &= 2800 \text{ rad/s.} \end{aligned}$$

Next, we compare  $\omega_0^2$  to  $\alpha^2$  and note that  $\omega_0^2 > \alpha^2$ , because

$$\begin{aligned}\alpha^2 &= 7.84 \times 10^6 \\ &= 0.0784 \times 10^8.\end{aligned}$$

At this point, we know that the response is underdamped and that the solution for  $i(t)$  is of the form

$$i(t) = B_1 e^{-\alpha t} \cos \omega_d t + B_2 e^{-\alpha t} \sin \omega_d t,$$

where  $\alpha = 2800$  rad/s and  $\omega_d = 9600$  rad/s. The numerical values of  $B_1$  and  $B_2$  come from the initial conditions. The inductor current is zero before the switch has been closed, and hence it is zero immediately after. Therefore

$$i(0) = 0 = B_1.$$

To find  $B_2$ , we evaluate  $di(0^+)/dt$ . From the circuit, we note that, because  $i(0) = 0$  immediately after the switch has been closed, there will be no voltage drop across the resistor. Thus the initial voltage on the capacitor appears across the terminals of the inductor, which leads to the expression,

$$L \frac{di(0^+)}{dt} = V_0,$$

or

$$\begin{aligned}\frac{di(0^+)}{dt} &= \frac{V_0}{L} = \frac{100}{100} \times 10^3 \\ &= 1000 \text{ A/s}.\end{aligned}$$

Because  $B_1 = 0$ ,

$$\frac{di}{dt} = 400B_2 e^{-2800t} (24 \cos 9600t - 7 \sin 9600t).$$

Thus

$$\begin{aligned}\frac{di(0^+)}{dt} &= 9600B_2, \\ B_2 &= \frac{1000}{9600} \approx 0.1042 \text{ A}.\end{aligned}$$

The solution for  $i(t)$  is

$$i(t) = 0.1042 e^{-2800t} \sin 9600t \text{ A}, \quad t \geq 0.$$

b) To find  $v_C(t)$ , we can use either of the following relationships:

$$\begin{aligned}v_C &= -\frac{1}{C} \int_0^t i d\tau + 100 \text{ or} \\ v_C &= iR + L \frac{di}{dt}.\end{aligned}$$

Whichever expression is used (the second is recommended), the result is

$$v_C(t) = (100 \cos 9600t + 29.17 \sin 9600t) e^{-2800t} \text{ V}, \quad t \geq 0.$$

### Example 8.12 Finding the Underdamped Step Response of a Series RLC Circuit

No energy is stored in the 100 mH inductor or the  $0.4 \mu\text{F}$  capacitor when the switch in the circuit shown in Fig. 8.17 is closed. Find  $v_C(t)$  for  $t \geq 0$ .

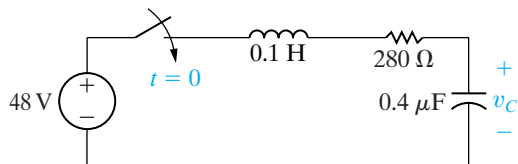


Figure 8.17 ▲ The circuit for Example 8.12.

#### Solution

The roots of the characteristic equation are

$$\begin{aligned}s_1 &= -\frac{280}{0.2} + \sqrt{\left(\frac{280}{0.2}\right)^2 - \frac{10^6}{(0.1)(0.4)}} \\ &= (-1400 + j4800) \text{ rad/s}, \\ s_2 &= (-1400 - j4800) \text{ rad/s}.\end{aligned}$$

The roots are complex, so the voltage response is underdamped. Thus

$$\begin{aligned}v_C(t) &= 48 + B_1' e^{-1400t} \cos 4800t \\ &\quad + B_2' e^{-1400t} \sin 4800t, \quad t \geq 0.\end{aligned}$$

No energy is stored in the circuit initially, so both  $v_C(0)$  and  $dv_C(0^+)/dt$  are zero. Then,

$$v_C(0) = 0 = 48 + B_1',$$

$$\frac{dv_C(0^+)}{dt} = 0 = 4800B_2' - 1400B_1'.$$

Solving for  $B_1'$  and  $B_2'$  yields

$$B_1' = -48 \text{ V},$$

$$B_2' = -14 \text{ V}.$$

Therefore, the solution for  $v_C(t)$  is

$$\begin{aligned}v_C(t) &= (48 - 48e^{-1400t} \cos 4800t \\ &\quad - 14e^{-1400t} \sin 4800t) \text{ V}, \quad t \geq 0.\end{aligned}$$



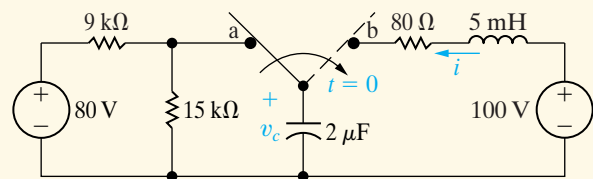
## ASSESSMENT PROBLEMS

**Objective 2**—Be able to determine the natural response and the step response of series *RLC* circuits

- 8.7** The switch in the circuit shown has been in position a for a long time. At  $t = 0$ , it moves to position b. Find (a)  $i(0^+)$ ; (b)  $v_C(0^+)$ ; (c)  $di(0^+)/dt$ ; (d)  $s_1, s_2$ ; and (e)  $i(t)$  for  $t \geq 0$ .

- Answer:** (a) 0;  
 (b) 50 V;  
 (c) 10,000 A/s;  
 (d)  $(-8000 + j6000)$  rad/s,  
 $(-8000 - j6000)$  rad/s;  
 (e)  $(1.67e^{-8000t} \sin 6000t)$  A for  $t \geq 0$ .

*NOTE:* Also try Chapter Problems 8.49–8.51.

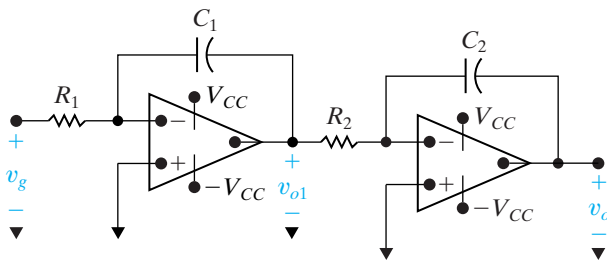


- 8.8** Find  $v_C(t)$  for  $t \geq 0$  for the circuit in Assessment Problem 8.7.

- Answer:**  $[100 - e^{-8000t}(50 \cos 6000t + 66.67 \sin 6000t)]$  V for  $t \geq 0$ .

## 8.5 A Circuit with Two Integrating Amplifiers

A circuit containing two integrating amplifiers connected in cascade<sup>1</sup> is also a second-order circuit; that is, the output voltage of the second integrator is related to the input voltage of the first by a second-order differential equation. We begin our analysis of a circuit containing two cascaded amplifiers with the circuit shown in Fig. 8.18.



**Figure 8.18** ▲ Two integrating amplifiers connected in cascade.

We assume that the op amps are ideal. The task is to derive the differential equation that establishes the relationship between  $v_o$  and  $v_g$ . We begin the derivation by summing the currents at the inverting input terminal of the first integrator. Because the op amp is ideal,

$$\frac{0 - v_g}{R_1} + C_1 \frac{d}{dt}(0 - v_{o1}) = 0. \quad (8.70)$$

From Eq. 8.70,

$$\frac{dv_{o1}}{dt} = -\frac{1}{R_1 C_1} v_g. \quad (8.71)$$

<sup>1</sup> In a cascade connection, the output signal of the first amplifier ( $v_{o1}$  in Fig. 8.18) is the input signal for the second amplifier.

Now we sum the currents away from the inverting input terminal of the second integrating amplifier:

$$\frac{0 - v_{o1}}{R_2} + C_2 \frac{d}{dt}(0 - v_o) = 0, \tag{8.72}$$

or

$$\frac{dv_o}{dt} = -\frac{1}{R_2 C_2} v_{o1}. \tag{8.73}$$

Differentiating Eq. 8.73 gives

$$\frac{d^2 v_o}{dt^2} = -\frac{1}{R_2 C_2} \frac{dv_{o1}}{dt}. \tag{8.74}$$

We find the differential equation that governs the relationship between  $v_o$  and  $v_g$  by substituting Eq. 8.71 into Eq. 8.74:

$$\frac{d^2 v_o}{dt^2} = \frac{1}{R_1 C_1} \frac{1}{R_2 C_2} v_g. \tag{8.75}$$

Example 8.13 illustrates the step response of a circuit containing two cascaded integrating amplifiers.

**Example 8.13 Analyzing Two Cascaded Integrating Amplifiers**

No energy is stored in the circuit shown in Fig. 8.19 when the input voltage  $v_g$  jumps instantaneously from 0 to 25 mV.

- a) Derive the expression for  $v_o(t)$  for  $0 \leq t \leq t_{\text{sat}}$ .
- b) How long is it before the circuit saturates?

**Solution**

- a) Figure 8.19 indicates that the amplifier scaling factors are

$$\frac{1}{R_1 C_1} = \frac{1000}{(250)(0.1)} = 40,$$

$$\frac{1}{R_2 C_2} = \frac{1000}{(500)(1)} = 2.$$

Now, because  $v_g = 25$  mV for  $t > 0$ , Eq. 8.75 becomes

$$\frac{d^2 v_o}{dt^2} = (40)(2)(25 \times 10^{-3}) = 2.$$

To solve for  $v_o$ , we let

$$g(t) = \frac{dv_o}{dt},$$

then,

$$\frac{dg(t)}{dt} = 2, \quad \text{and} \quad dg(t) = 2dt.$$

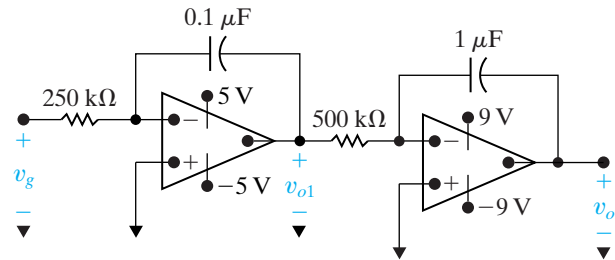


Figure 8.19 ▲ The circuit for Example 8.13.

Hence

$$\int_{g(0)}^{g(t)} dy = 2 \int_0^t dx,$$

from which

$$g(t) - g(0) = 2t.$$

However,

$$g(0) = \frac{dv_o(0)}{dt} = 0,$$

because the energy stored in the circuit initially is zero, and the op amps are ideal. (See Problem 8.57.) Then,

$$\frac{dv_o}{dt} = 2t, \quad \text{and} \quad v_o = t^2 + v_o(0).$$

But  $v_o(0) = 0$ , so the expression for  $v_o$  becomes

$$v_o = t^2, \quad 0 \leq t \leq t_{\text{sat}}.$$

b) The second integrating amplifier saturates when  $v_o$  reaches 9 V or  $t = 3$  s. But it is possible that the first integrating amplifier saturates before  $t = 3$  s. To explore this possibility, use Eq. 8.71 to find  $dv_{o1}/dt$ :

$$\frac{dv_{o1}}{dt} = -40(25) \times 10^{-3} = -1.$$

**NOTE:** Assess your understanding of this material by trying Chapter Problem 8.63.

Solving for  $v_{o1}$  yields

$$v_{o1} = -t.$$

Thus, at  $t = 3$  s,  $v_{o1} = -3$  V, and, because the power supply voltage on the first integrating amplifier is  $\pm 5$  V, the circuit reaches saturation when the second amplifier saturates. When one of the op amps saturates, we no longer can use the linear model to predict the behavior of the circuit.

## Two Integrating Amplifiers with Feedback Resistors

Figure 8.20 depicts a variation of the circuit shown in Fig. 8.18. Recall from Section 7.7 that the reason the op amp in the integrating amplifier saturates is the feedback capacitor's accumulation of charge. Here, a resistor is placed in parallel with each feedback capacitor ( $C_1$  and  $C_2$ ) to overcome this problem. We rederive the equation for the output voltage,  $v_o$ , and determine the impact of these feedback resistors on the integrating amplifiers from Example 8.13.

We begin the derivation of the second-order differential equation that relates  $v_{o1}$  to  $v_g$  by summing the currents at the inverting input node of the first integrator:

$$\frac{0 - v_g}{R_a} + \frac{0 - v_{o1}}{R_1} + C_1 \frac{d}{dt}(0 - v_{o1}) = 0. \quad (8.76)$$

We simplify Eq. 8.76 to read

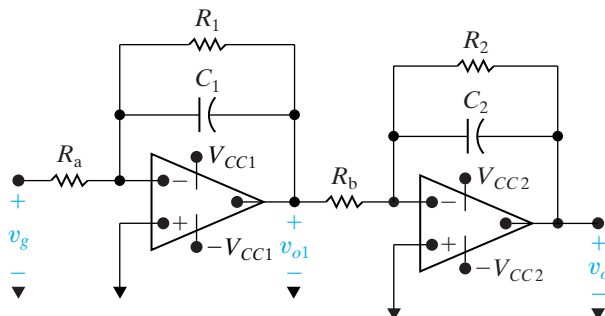
$$\frac{dv_{o1}}{dt} + \frac{1}{R_1 C_1} v_{o1} = \frac{-v_g}{R_a C_1}. \quad (8.77)$$

For convenience, we let  $\tau_1 = R_1 C_1$  and write Eq. 8.77 as

$$\frac{dv_{o1}}{dt} + \frac{v_{o1}}{\tau_1} = \frac{-v_g}{R_a C_1}. \quad (8.78)$$

The next step is to sum the currents at the inverting input terminal of the second integrator:

$$\frac{0 - v_{o1}}{R_b} + \frac{0 - v_o}{R_2} + C_2 \frac{d}{dt}(0 - v_o) = 0. \quad (8.79)$$



**Figure 8.20** ▲ Cascaded integrating amplifiers with feedback resistors.

We rewrite Eq. 8.79 as

$$\frac{dv_o}{dt} + \frac{v_o}{\tau_2} = \frac{-v_{o1}}{R_b C_2}, \quad (8.80)$$

where  $\tau_2 = R_2 C_2$ . Differentiating Eq. 8.80 yields

$$\frac{d^2 v_o}{dt^2} + \frac{1}{\tau_2} \frac{dv_o}{dt} = -\frac{1}{R_b C_2} \frac{dv_{o1}}{dt}. \quad (8.81)$$

From Eq. 8.78,

$$\frac{dv_{o1}}{dt} = \frac{-v_{o1}}{\tau_1} - \frac{v_g}{R_a C_1}, \quad (8.82)$$

and from Eq. 8.80,

$$v_{o1} = -R_b C_2 \frac{dv_o}{dt} - \frac{R_b C_2}{\tau_2} v_o. \quad (8.83)$$

We use Eqs. 8.82 and 8.83 to eliminate  $dv_{o1}/dt$  from Eq. 8.81 and obtain the desired relationship:

$$\frac{d^2 v_o}{dt^2} + \left( \frac{1}{\tau_1} + \frac{1}{\tau_2} \right) \frac{dv_o}{dt} + \left( \frac{1}{\tau_1 \tau_2} \right) v_o = \frac{v_g}{R_a C_1 R_b C_2}. \quad (8.84)$$

From Eq. 8.84, the characteristic equation is

$$s^2 + \left( \frac{1}{\tau_1} + \frac{1}{\tau_2} \right) s + \frac{1}{\tau_1 \tau_2} = 0. \quad (8.85)$$

The roots of the characteristic equation are real, namely,

$$s_1 = \frac{-1}{\tau_1}, \quad (8.86)$$

$$s_2 = \frac{-1}{\tau_2}. \quad (8.87)$$

Example 8.14 illustrates the analysis of the step response of two cascaded integrating amplifiers when the feedback capacitors are shunted with feedback resistors.

**Example 8.14** Analyzing Two Cascaded Integrating Amplifiers with Feedback Resistors

The parameters for the circuit shown in Fig. 8.20 are  $R_a = 100 \text{ k}\Omega$ ,  $R_1 = 500 \text{ k}\Omega$ ,  $C_1 = 0.1 \text{ }\mu\text{F}$ ,  $R_b = 25 \text{ k}\Omega$ ,  $R_2 = 100 \text{ k}\Omega$ , and  $C_2 = 1 \text{ }\mu\text{F}$ . The power supply voltage for each op amp is  $\pm 6 \text{ V}$ . The signal voltage ( $v_g$ ) for the cascaded integrating amplifiers jumps from 0 to 250 mV at  $t = 0$ . No energy is stored in the feedback capacitors at the instant the signal is applied.

- Find the numerical expression of the differential equation for  $v_o$ .
- Find  $v_o(t)$  for  $t \geq 0$ .
- Find the numerical expression of the differential equation for  $v_{o1}$ .
- Find  $v_{o1}(t)$  for  $t \geq 0$ .

**Solution**

- From the numerical values of the circuit parameters, we have  $\tau_1 = R_1 C_1 = 0.05 \text{ s}$ ;  $\tau_2 = R_2 C_2 = 0.10 \text{ s}$ , and  $v_g/R_a C_1 R_b C_2 = 1000 \text{ V/s}^2$ . Substituting these values into Eq. 8.84 gives

$$\frac{d^2 v_o}{dt^2} + 30 \frac{dv_o}{dt} + 200 v_o = 1000.$$

- The roots of the characteristic equation are  $s_1 = -20 \text{ rad/s}$  and  $s_2 = -10 \text{ rad/s}$ . The final value of  $v_o$  is the input voltage times the gain of each stage, because the capacitors behave as open circuits as  $t \rightarrow \infty$ . Thus,

$$v_o(\infty) = (250 \times 10^{-3}) \frac{(-500)}{100} \frac{(-100)}{25} = 5 \text{ V}.$$

**NOTE:** Assess your understanding of this material by trying Chapter Problem 8.64.

The solution for  $v_o$  thus takes the form:

$$v_o = 5 + A'_1 e^{-10t} + A'_2 e^{-20t}.$$

With  $v_o(0) = 0$  and  $dv_o(0)/dt = 0$ , the numerical values of  $A'_1$  and  $A'_2$  are  $A'_1 = -10 \text{ V}$  and  $A'_2 = 5 \text{ V}$ . Therefore, the solution for  $v_o$  is

$$v_o(t) = (5 - 10e^{-10t} + 5e^{-20t}) \text{ V}, \quad t \geq 0.$$

The solution assumes that neither op amp saturates. We have already noted that the final value of  $v_o$  is 5 V, which is less than 6 V; hence the second op amp does not saturate. The final value of  $v_{o1}$  is  $(250 \times 10^{-3})(-500/100)$ , or  $-1.25 \text{ V}$ . Therefore, the first op amp does not saturate, and our assumption and solution are correct.

- Substituting the numerical values of the parameters into Eq. 8.78 generates the desired differential equation:

$$\frac{dv_{o1}}{dt} + 20v_{o1} = -25.$$

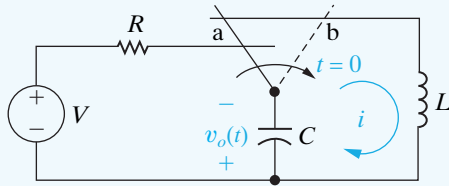
- We have already noted the initial and final values of  $v_{o1}$ , along with the time constant  $\tau_1$ . Thus we write the solution in accordance with the technique developed in Section 7.4:

$$\begin{aligned} v_{o1} &= -1.25 + [0 - (-1.25)]e^{-20t} \\ &= -1.25 + 1.25e^{-20t} \text{ V}, \quad t \geq 0. \end{aligned}$$

## Practical Perspective

### Clock for Computer Timing

Consider the circuit in Fig. 8.21, where the output is the voltage drop across the capacitor. For  $t \geq 0$  this circuit looks like a series  $RLC$  natural-response circuit of Fig. 8.3 without its resistor. When we analyze this  $LC$  circuit, we will discover that its output is an undamped sinusoid, which could be used by a computer's clock generator instead of the typical quartz crystal oscillator. We will be able to specify the frequency of the clock by selecting appropriate values for the inductor and capacitor.



**Figure 8.21** ▲ An LC natural response circuit.

Begin by writing the KVL equation for the circuit in Fig. 8.21, using the current  $i$ , for  $t \geq 0$ :

$$L \frac{di(t)}{dt} + \frac{1}{C} \int_0^t i(x) dx = 0.$$

To get rid of the integral term, integral both sides with respect to  $t$  to get

$$L \frac{d^2i(t)}{dt^2} + \frac{1}{C} i(t) = 0.$$

The describing differential equation is thus

$$\frac{d^2i(t)}{dt^2} + \frac{1}{LC} i(t) = 0.$$

What mathematical function can be added to its second derivative to get zero? A sinusoid in the form  $i(t) = A \cos \omega_0 t$  will work:

$$\frac{d^2}{dt^2} A \cos \omega_0 t + \frac{1}{LC} A \cos \omega_0 t = -\omega_0^2 A \cos \omega_0 t + \frac{1}{LC} A \cos \omega_0 t = 0.$$

This equation is satisfied when

$$\omega_0^2 = \frac{1}{LC} \quad \text{or when} \quad \omega_0 = \sqrt{\frac{1}{LC}}.$$

The frequency  $\omega_0$  is the familiar resonant radian frequency of both the series and parallel RLC circuits, whose units are radians/second. Note that the LC circuit does not have a neper frequency,  $\alpha$ .

We choose the value of  $A$  to satisfy the initial condition for the current in the inductor:

$$i(0) = A \cos \omega_0(0) = \frac{V}{R} \quad \text{so} \quad A = \frac{V}{R}.$$

Therefore, the current for the circuit in Fig. 8.21 is

$$i(t) = \frac{V}{R} \cos \omega_0(t), \quad \text{where} \quad \omega_0 = \sqrt{\frac{1}{LC}}.$$

We can now use the expression for the current in the circuit to find the voltage output by the capacitor:

$$v_C(t) = \frac{1}{C} \int_0^t i(x) dx = \frac{1}{C} \int_0^t \frac{V}{R} \cos \omega_0 x dx = \frac{V}{\omega_0 RC} \sin \omega_0 t.$$

By choosing values for  $L$  and  $C$  we can use the circuit in Fig. 8.21 to generate an undamped sinusoid for  $t \geq 0$  for a computer's clock generator.

So why is a quartz crystal used to generate the sinusoid for the clock generator instead of the LC circuit of Fig. 8.21? Remember that our analysis of the LC circuit assumed that the inductor and capacitor are ideal. But ideal inductors and capacitors do not exist – real inductors and capacitors have a small amount of resistance. We leave it to you to examine the effect of this small amount of resistance on the performance of an LC oscillator in the Chapter Problems.

*NOTE: Assess your understanding of the Practical Perspective by solving Chapter Problems 8.66–8.68.*

## Summary

- The **characteristic equation** for both the parallel and series *RLC* circuits has the form

$$s^2 + 2\alpha s + \omega_0^2 = 0,$$

where  $\alpha = 1/2RC$  for the parallel circuit,  $\alpha = R/2L$  for the series circuit, and  $\omega_0^2 = 1/LC$  for both the parallel and series circuits. (See pages 267 and 286.)

- The roots of the characteristic equation are

$$s_{1,2} = -\alpha \pm \sqrt{\alpha^2 - \omega_0^2}.$$

(See page 268.)

- The form of the natural and step responses of series and parallel *RLC* circuits depends on the values of  $\alpha^2$  and  $\omega_0^2$ ; such responses can be **overdamped**, **underdamped**, or **critically damped**. These terms describe the impact of the dissipative element (*R*) on the response. The **neper frequency**,  $\alpha$ , reflects the effect of *R*. (See pages 268 and 269.)
- The response of a second-order circuit is overdamped, underdamped, or critically damped as shown in Table 8.2.
- In determining the **natural response** of a second-order circuit, we first determine whether it is over-, under-, or

critically damped, and then we solve the appropriate equations as shown in Table 8.3.

- In determining the **step response** of a second-order circuit, we apply the appropriate equations depending on the damping, as shown in Table 8.4.
- For each of the three forms of response, the unknown coefficients (i.e., the *A*s, *B*s, and *D*s) are obtained by evaluating the circuit to find the initial value of the response,  $x(0)$ , and the initial value of the first derivative of the response,  $dx(0)/dt$ .
- When two integrating amplifiers with ideal op amps are connected in cascade, the output voltage of the second integrator is related to the input voltage of the first by an ordinary, second-order differential equation. Therefore, the techniques developed in this chapter may be used to analyze the behavior of a cascaded integrator. (See pages 289 and 290.)
- We can overcome the limitation of a simple integrating amplifier—the saturation of the op amp due to charge accumulating in the feedback capacitor—by placing a resistor in parallel with the capacitor in the feedback path. (See page 291.)

**TABLE 8.2** The Response of a Second-Order Circuit is Overdamped, Underdamped, or Critically Damped

The Circuit is	When	Qualitative Nature of the Response
Overdamped	$\alpha^2 > \omega_0^2$	The voltage or current approaches its final value without oscillation
Underdamped	$\alpha^2 < \omega_0^2$	The voltage or current oscillates about its final value
Critically damped	$\alpha^2 = \omega_0^2$	The voltage or current is on the verge of oscillating about its final value

**TABLE 8.3** In Determining the Natural Response of a Second-Order Circuit, We First Determine Whether it is Over-, Under-, or Critically Damped, and Then We Solve the Appropriate Equations

Damping	Natural Response Equations	Coefficient Equations
Overdamped	$x(t) = A_1e^{s_1t} + A_2e^{s_2t}$	$x(0) = A_1 + A_2;$ $dx/dt(0) = A_1s_1 + A_2s_2$
Underdamped	$x(t) = (B_1 \cos \omega_d t + B_2 \sin \omega_d t)e^{-\alpha t}$	$x(0) = B_1;$ $dx/dt(0) = -\alpha B_1 + \omega_d B_2,$ where $\omega_d = \sqrt{\omega_0^2 - \alpha^2}$
Critically damped	$x(t) = (D_1 t + D_2)e^{-\alpha t}$	$x(0) = D_2,$ $dx/dt(0) = D_1 - \alpha D_2$



**TABLE 8.4** In Determining the Step Response of a Second-Order Circuit, We Apply the Appropriate Equations Depending on the Damping

Damping	Step Response Equations <sup>a</sup>	Coefficient Equations
Overdamped	$x(t) = X_f + A_1' e^{s_1 t} + A_2' e^{s_2 t}$	$x(0) = X_f + A_1' + A_2'$ ; $dx/dt(0) = A_1' s_1 + A_2' s_2$
Underdamped	$x(t) = X_f + (B_1' \cos \omega_d t + B_2' \sin \omega_d t) e^{-\alpha t}$	$x(0) = X_f + B_1'$ ; $dx/dt(0) = -\alpha B_1' + \omega_d B_2'$
Critically damped	$x(t) = X_f + D_1' t e^{-\alpha t} + D_2' e^{-\alpha t}$	$x(0) = X_f + D_2'$ ; $dx/dt(0) = D_1' - \alpha D_2'$

<sup>a</sup> where  $X_f$  is the final value of  $x(t)$ .

## Problems

### Sections 8.1–8.2

**8.1** The circuit elements in the circuit in Fig. 8.1 are  $R = 125 \Omega$ ,  $L = 200 \text{ mH}$ , and  $C = 5 \mu\text{F}$ . The initial inductor current is  $-0.3 \text{ A}$  and the initial capacitor voltage is  $25 \text{ V}$ .

PSPICE  
MULTISIM

- Calculate the initial current in each branch of the circuit.
- Find  $v(t)$  for  $t \geq 0$ .
- Find  $i_L(t)$  for  $t \geq 0$ .

**8.2** The resistance in Problem 8.1 is decreased to  $100 \Omega$ . Find the expression for  $v(t)$  for  $t \geq 0$ .

PSPICE  
MULTISIM

**8.3** The resistance in Problem 8.1 is decreased to  $80 \Omega$ . Find the expression for  $v(t)$  for  $t \geq 0$ .

PSPICE  
MULTISIM

**8.4** The resistance, inductance, and capacitance in a parallel RLC circuit are  $2000 \Omega$ ,  $250 \text{ mH}$ , and  $10 \text{ nF}$ , respectively.

- Calculate the roots of the characteristic equation that describe the voltage response of the circuit.
- Will the response be over-, under-, or critically damped?
- What value of  $R$  will yield a damped frequency of  $12 \text{ krad/s}$ ?
- What are the roots of the characteristic equation for the value of  $R$  found in (c)?
- What value of  $R$  will result in a critically damped response?

**8.5** Suppose the inductor in the circuit shown in Fig. 8.1 has a value of  $10 \text{ mH}$ . The voltage response for  $t \geq 0$  is

$$v(t) = 40e^{-1000t} - 90e^{-4000t} \text{ V.}$$

- Determine the numerical values of  $\omega_0$ ,  $\alpha$ ,  $C$ , and  $R$ .
  - Calculate  $i_R(t)$ ,  $i_L(t)$ , and  $i_C(t)$  for  $t \geq 0^+$ .
- 8.6** The natural voltage response of the circuit in Fig. 8.1 is

$$v(t) = 120e^{-400t} \cos 300t + 80e^{-400t} \sin 300t \text{ V,}$$

when the capacitor is  $250 \mu\text{F}$ . Find (a)  $L$ ; (b)  $R$ ; (c)  $V_0$ ; (d)  $I_0$ ; and (e)  $i_L(t)$ .

**8.7** The voltage response for the circuit in Fig. 8.1 is known to be

$$v(t) = D_1 t e^{-80t} + D_2 e^{-80t}, \quad t \geq 0.$$

The initial current in the inductor ( $I_0$ ) is  $-25 \text{ mA}$ , and the initial voltage on the capacitor ( $V_0$ ) is  $5 \text{ V}$ . The resistor has a value of  $50 \Omega$ .

- Find the values of  $C$ ,  $L$ ,  $D_1$ , and  $D_2$ .
  - Find  $i_C(t)$  for  $t \geq 0^+$ .
- 8.8** In the circuit shown in Fig. 8.1, a  $20 \text{ mH}$  inductor is shunted by a  $500 \text{ nF}$  capacitor, the resistor  $R$  is adjusted for critical damping, and  $I_0 = 120 \text{ mA}$ .

PSPICE  
MULTISIM

- Calculate the numerical value of  $R$ .
- Calculate  $v(t)$  for  $t \geq 0$ .
- Find  $v(t)$  when  $i_C(t) = 0$ .
- What percentage of the initially stored energy remains stored in the circuit at the instant  $i_C(t)$  is 0?

**8.9** The natural response for the circuit shown in Fig. 8.1 is known to be

$$v(t) = -11e^{-100t} + 20e^{-400t} \text{ V}, \quad t \geq 0.$$

If  $C = 2 \mu\text{F}$  and  $L = 12.5 \text{ H}$ , find  $i_L(0^+)$  in milliamperes.

**8.10** The resistor in the circuit in Example 8.4 is changed to  $3200 \Omega$ .

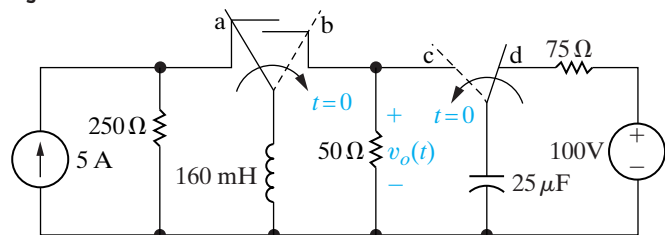
PSPICE  
MULTISIM

- Find the numerical expression for  $v(t)$  when  $t \geq 0$ .
- Plot  $v(t)$  versus  $t$  for the time interval  $0 \leq t \leq 7 \text{ ms}$ . Compare this response with the one in Example 8.4 ( $R = 20 \text{ k}\Omega$ ) and Example 8.5 ( $R = 4 \text{ k}\Omega$ ). In particular, compare peak values of  $v(t)$  and the times when these peak values occur.

**8.11** The two switches in the circuit seen in Fig. P8.11 operate synchronously. When switch 1 is in position a, switch 2 is in position d. When switch 1 moves to position b, switch 2 moves to position c. Switch 1 has been in position a for a long time. At  $t = 0$ , the switches move to their alternate positions. Find  $v_o(t)$  for  $t \geq 0$ .

PSPICE  
MULTISIM

Figure P8.11



**8.12** The resistor in the circuit of Fig. P8.11 is decreased from  $50 \Omega$  to  $40 \Omega$ . Find  $v_o(t)$  for  $t \geq 0$ .

PSPICE  
MULTISIM

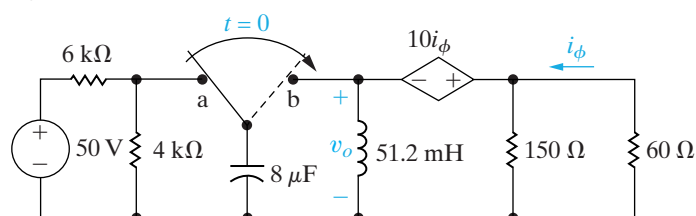
**8.13** The resistor in the circuit of Fig. P8.11 is decreased from  $50 \Omega$  to  $32 \Omega$ . Find  $v_o(t)$  for  $t \geq 0$ .

PSPICE  
MULTISIM

**8.14** The switch in the circuit of Fig. P8.14 has been in position a for a long time. At  $t = 0$  the switch moves instantaneously to position b. Find  $v_o(t)$  for  $t \geq 0$ .

PSPICE  
MULTISIM

Figure P8.14



**8.15** The inductor in the circuit of Fig. P8.14 is increased to  $80 \text{ mH}$ . Find  $v_o(t)$  for  $t \geq 0$ .

**8.16** The inductor in the circuit of Fig. P8.14 is increased to  $125 \text{ mH}$ . Find  $v_o(t)$  for  $t \geq 0$ .

**8.17** a) Design a parallel  $RLC$  circuit (see Fig. 8.1) using component values from Appendix H, with a resonant radian frequency of  $5000 \text{ rad/s}$ . Choose a resistor or create a resistor network so that the response is critically damped. Draw your circuit.

b) Calculate the roots of the characteristic equation for the resistance in part (a).

**8.18** a) Change the resistance for the circuit you designed in Problem 8.5(a) so that the response is underdamped. Continue to use components from Appendix H. Calculate the roots of the characteristic equation for this new resistance.

b) Change the resistance for the circuit you designed in Problem 8.5(a) so that the response is overdamped. Continue to use components from Appendix H. Calculate the roots of the characteristic equation for this new resistance.

**8.19** In the circuit in Fig. 8.1,  $R = 5 \text{ k}\Omega$ ,  $L = 8 \text{ H}$ ,  $C = 125 \text{ nF}$ ,  $V_0 = 30 \text{ V}$ , and  $I_0 = 6 \text{ mA}$ .

PSPICE  
MULTISIM

- Find  $v(t)$  for  $t \geq 0$ .
- Find the first three values of  $t$  for which  $dv/dt$  is zero. Let these values of  $t$  be denoted  $t_1$ ,  $t_2$ , and  $t_3$ .
- Show that  $t_3 - t_1 = T_d$ .
- Show that  $t_2 - t_1 = T_d/2$ .
- Calculate  $v(t_1)$ ,  $v(t_2)$ , and  $v(t_3)$ .
- Sketch  $v(t)$  versus  $t$  for  $0 \leq t \leq t_2$ .

**8.20** a) Find  $v(t)$  for  $t \geq 0$  in the circuit in Problem 8.19 if the  $5 \text{ k}\Omega$  resistor is removed from the circuit.

PSPICE  
MULTISIM

b) Calculate the frequency of  $v(t)$  in hertz.

c) Calculate the maximum amplitude of  $v(t)$  in volts.

**8.21** Assume the underdamped voltage response of the circuit in Fig. 8.1 is written as

$$v(t) = (A_1 + A_2)e^{-\alpha t} \cos \omega_d t + j(A_1 - A_2)e^{-\alpha t} \sin \omega_d t$$

The initial value of the inductor current is  $I_0$ , and the initial value of the capacitor voltage is  $V_0$ . Show that  $A_2$  is the conjugate of  $A_1$ . (Hint: Use the same process as outlined in the text to find  $A_1$  and  $A_2$ .)

**8.22** Show that the results obtained from Problem 8.21—that is, the expressions for  $A_1$  and  $A_2$ —are consistent with Eqs. 8.30 and 8.31 in the text.

**8.23** The initial value of the voltage  $v$  in the circuit in Fig. 8.1 is zero, and the initial value of the capacitor current,  $i_c(0^+)$ , is 45 mA. The expression for the capacitor current is known to be

$$i_c(t) = A_1 e^{-200t} + A_2 e^{-800t}, \quad t \geq 0^+,$$

when  $R$  is 250  $\Omega$ . Find

a) the values of  $\alpha$ ,  $\omega_0$ ,  $L$ ,  $C$ ,  $A_1$ , and  $A_2$

$$\left( \text{Hint: } \frac{di_C(0^+)}{dt} = -\frac{di_L(0^+)}{dt} - \frac{di_R(0^+)}{dt} = \frac{-v(0)}{L} - \frac{1}{R} \frac{i_C(0^+)}{C} \right)$$

b) the expression for  $v(t)$ ,  $t \geq 0$ ,

c) the expression for  $i_R(t) \geq 0$ ,

d) the expression for  $i_L(t) \geq 0$ .

### Section 8.3

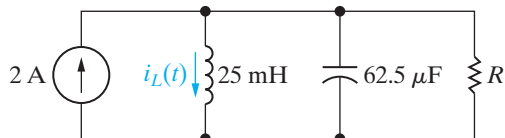
**8.24** For the circuit in Example 8.6, find, for  $t \geq 0$ , (a)  $v(t)$ ; (b)  $i_R(t)$ ; and (c)  $i_C(t)$ .

**8.25** For the circuit in Example 8.7, find, for  $t \geq 0$ , (a)  $v(t)$  and (b)  $i_C(t)$ .

**8.26** For the circuit in Example 8.8, find  $v(t)$  for  $t \geq 0$ .

**8.27** Assume that at the instant the 2 A dc current source is applied to the circuit in Fig. P8.27, the initial current in the 25 mH inductor is 1 A, and the initial voltage on the capacitor is 50 V (positive at the upper terminal). Find the expression for  $i_L(t)$  for  $t \geq 0$  if  $R$  equals 12.5  $\Omega$ .

Figure P8.27

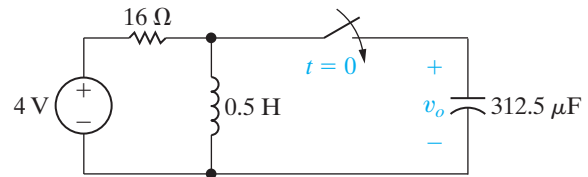


**8.28** The resistance in the circuit in Fig. P8.27 is changed to 8  $\Omega$ . Find  $i_L(t)$  for  $t \geq 0$ .

**8.29** The resistance in the circuit in Fig. P8.27 is changed to 10  $\Omega$ . Find  $i_L(t)$  for  $t \geq 0$ .

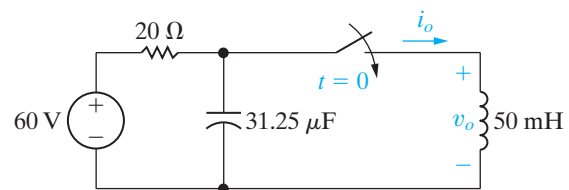
**8.30** The switch in the circuit in Fig. P8.30 has been open a long time before closing at  $t = 0$ . At the time the switch closes, the capacitor has no stored energy. Find  $v_o$  for  $t \geq 0$ .

Figure P8.30



**8.31** The switch in the circuit in Fig. P8.31 has been open for a long time before closing at  $t = 0$ . Find  $i_o(t)$  for  $t \geq 0$ .

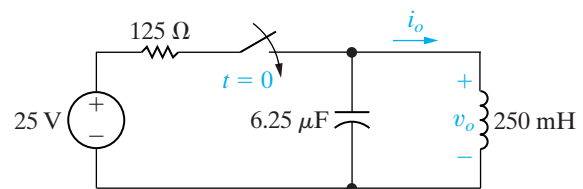
Figure P8.31



**8.32** a) For the circuit in Fig. P8.31, find  $v_o$  for  $t \geq 0$ .  
b) Show that your solution for  $v_o$  is consistent with the solution for  $i_o$  in Problem 8.31.

**8.33** There is no energy stored in the circuit in Fig. P8.33 when the switch is closed at  $t = 0$ . Find  $i_o(t)$  for  $t \geq 0$ .

Figure P8.33



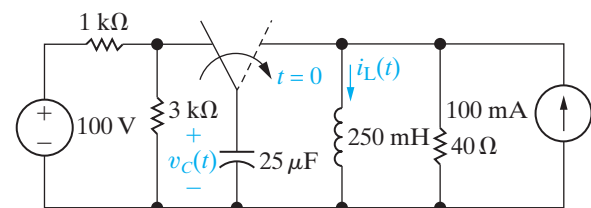
**8.34** a) For the circuit in Fig. P8.33, find  $v_o$  for  $t \geq 0$ .  
b) Show that your solution for  $v_o$  is consistent with the solution for  $i_o$  in Problem 8.33.

**8.35** The switch in the circuit in Fig. P8.35 has been in the left position for a long time before moving to the right position at  $t = 0$ . Find

a)  $i_L(t)$  for  $t \geq 0$ ,

b)  $v_C(t)$  for  $t \geq 0$ .

Figure P8.35



**8.36** Use the circuit in Fig. P8.35

PSPICE  
MULTISIM

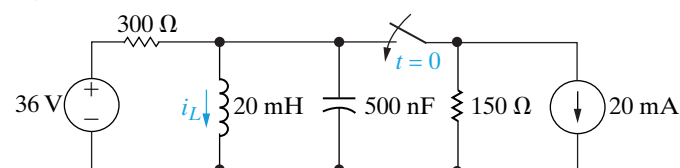
- Find the total energy delivered to the inductor.
- Find the total energy delivered to the 40  $\Omega$  resistor.
- Find the total energy delivered to the capacitor.
- Find the total energy delivered by the current source.
- Check the results of parts (a) through (d) against the conservation of energy principle.

**8.37** The switch in the circuit in Fig. P8.37 has been

PSPICE  
MULTISIM

open a long time before closing at  $t = 0$ . Find  $i_L(t)$  for  $t \geq 0$ .

Figure P8.37

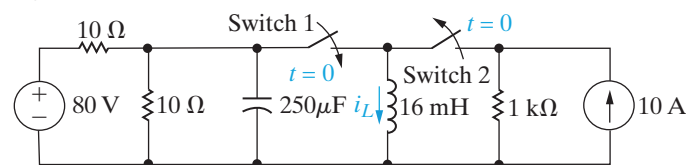


**8.38** Switches 1 and 2 in the circuit in Fig. P8.38 are syn-

PSPICE  
MULTISIM

chronized. When switch 1 is opened, switch 2 closes and vice versa. Switch 1 has been open a long time before closing at  $t = 0$ . Find  $i_L(t)$  for  $t \geq 0$ .

Figure P8.38



## Section 8.4

**8.39** The current in the circuit in Fig. 8.3 is known to be

$$i = B_1 e^{-2000t} \cos 1500t + B_2 e^{-2000t} \sin 1500t, \quad t \geq 0.$$

The capacitor has a value of 80 nF; the initial value of the current is 7.5 mA; and the initial voltage on the capacitor is  $-30$  V. Find the values of  $R$ ,  $L$ ,  $B_1$ , and  $B_2$ .

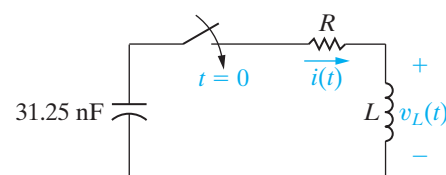
**8.40** Find the voltage across the 80 nF capacitor for the circuit described in Problem 8.39. Assume the reference polarity for the capacitor voltage is positive at the upper terminal.

**8.41** The initial energy stored in the 31.25 nF capacitor in the circuit in Fig. P8.41 is 9  $\mu$ J. The initial energy stored in the inductor is zero. The roots of the characteristic equation that describes the natural

behavior of the current  $i$  are  $-4000 \text{ s}^{-1}$  and  $-16,000 \text{ s}^{-1}$

- Find the numerical values of  $R$  and  $L$ .
- Find the numerical values of  $i(0)$  and  $di(0)/dt$  immediately after the switch has been closed.
- Find  $i(t)$  for  $t \geq 0$ .
- How many microseconds after the switch closes does the current reach its maximum value?
- What is the maximum value of  $i$  in milliamperes?
- Find  $v_L(t)$  for  $t \geq 0$ .

Figure P8.41



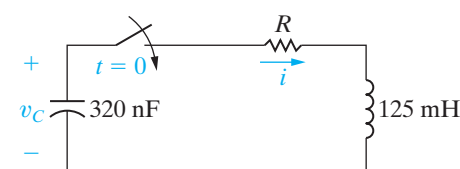
**8.42** In the circuit in Fig. P8.42, the resistor is adjusted

PSPICE  
MULTISIM

for critical damping. The initial capacitor voltage is 15 V, and the initial inductor current is 6 mA.

- Find the numerical value of  $R$ .
- Find the numerical values of  $i$  and  $di/dt$  immediately after the switch is closed.
- Find  $v_C(t)$  for  $t \geq 0$ .

Figure P8.42



- Design a series  $RLC$  circuit (see Fig. 8.3) using component values from Appendix H, with a resonant radian frequency of 20 krad/s. Choose a resistor or create a resistor network so that the response is critically damped. Draw your circuit.
- Calculate the roots of the characteristic equation for the resistance in part (a).

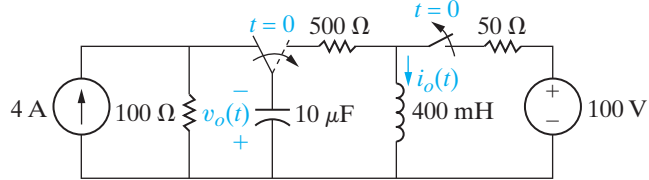
- Change the resistance for the circuit you designed in Problem 8.43(a) so that the response is underdamped. Continue to use components from Appendix H. Calculate the roots of the characteristic equation for this new resistance.
- Change the resistance for the circuit you designed in Problem 8.43(a) so that the response is overdamped. Continue to use components from Appendix H. Calculate the roots of the characteristic equation for this new resistance.

**8.45** The circuit shown in Fig. P8.45 has been in operation for a long time. At  $t = 0$ , the two switches move to the new positions shown in the figure. Find

PSPICE  
MULTISIM

- a)  $i_o(t)$  for  $t \geq 0$ ,
- b)  $v_o(t)$  for  $t \geq 0$ .

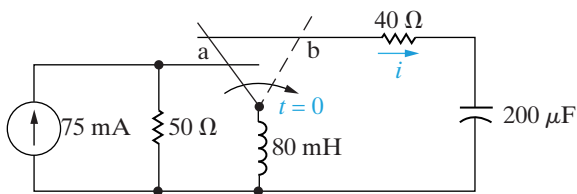
Figure P8.45



**8.46** The switch in the circuit shown in Fig. P8.46 has been in position a for a long time. At  $t = 0$ , the switch is moved instantaneously to position b. Find  $i(t)$  for  $t \geq 0$ .

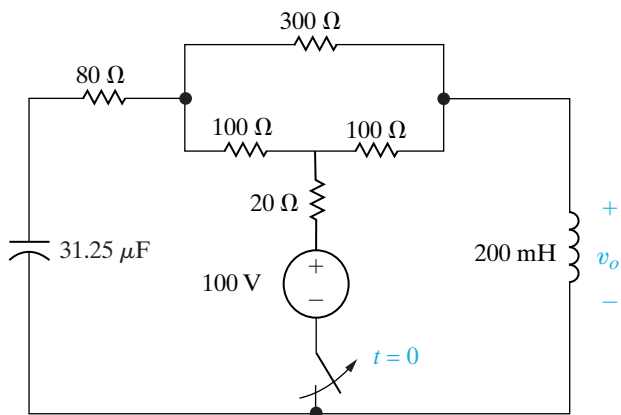
PSPICE  
MULTISIM

Figure P8.46



**8.47** The switch in the circuit shown in Fig. P8.47 has been closed for a long time. The switch opens at  $t = 0$ . Find  $v_o(t)$  for  $t \geq 0^+$ .

Figure P8.47

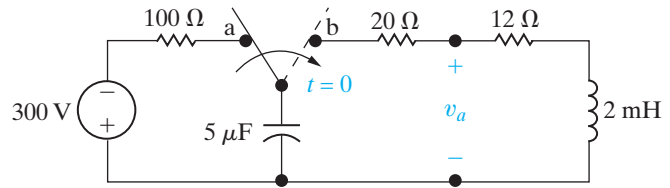


**8.48** The switch in the circuit in Fig. P8.48 has been in position a for a long time. At  $t = 0$ , the switch moves instantaneously to position b.

PSPICE  
MULTISIM

- a) What is the initial value of  $v_a$ ?
- b) What is the initial value of  $dv_a/dt$ ?
- c) What is the numerical expression for  $v_a(t)$  for  $t \geq 0$ ?

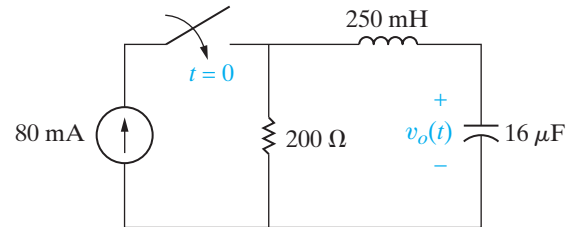
Figure P8.48



**8.49** The initial energy stored in the circuit in Fig. P8.49 is zero. Find  $v_o(t)$  for  $t \geq 0$ .

PSPICE  
MULTISIM

Figure P8.49



**8.50** The resistor in the circuit shown in Fig. P8.49 is changed to 250 Ω. The initial energy stored is still zero. Find  $v_o(t)$  for  $t \geq 0$ .

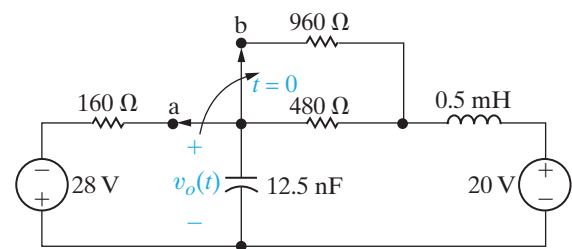
PSPICE  
MULTISIM

**8.51** The resistor in the circuit shown in Fig. P8.49 is changed to 312.5 Ω. The initial energy stored is still zero. Find  $v_o(t)$  for  $t \geq 0$ .

**8.52** The switch in the circuit of Fig. P8.52 has been in position a for a long time. At  $t = 0$  the switch moves instantaneously to position b. Find  $v_o(t)$  for  $t \geq 0$ .

PSPICE  
MULTISIM

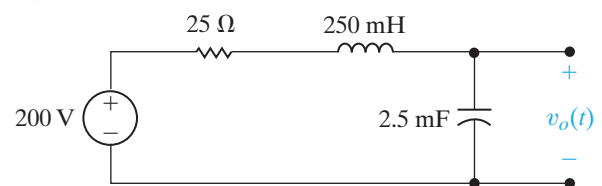
Figure P8.52



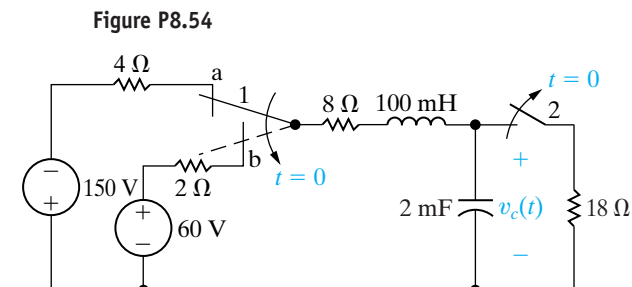
**8.53** The circuit shown in Fig. P8.53 has been in operation for a long time. At  $t = 0$ , the source voltage suddenly drops to 150 V. Find  $v_o(t)$  for  $t \geq 0$ .

PSPICE  
MULTISIM

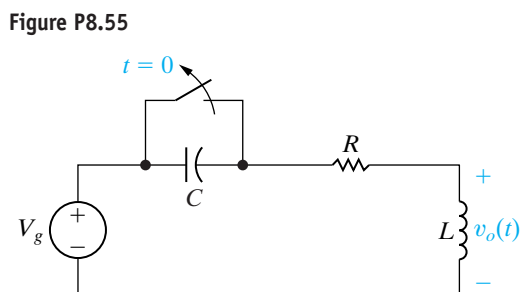
Figure P8.53



- 8.54** The two switches in the circuit seen in Fig. P8.55 operate synchronously. When switch 1 is in position a, switch 2 is closed. When switch 1 is in position b, switch 2 is open. Switch 1 has been in position a for a long time. At  $t = 0$ , it moves instantaneously to position b. Find  $v_c(t)$  for  $t \geq 0$ .



- 8.55** The switch in the circuit shown in Fig. P8.55 has been closed for a long time before it is opened at  $t = 0$ . Assume that the circuit parameters are such that the response is underdamped.
- Derive the expression for  $v_o(t)$  as a function of  $V_g$ ,  $\alpha$ ,  $\omega_d$ ,  $C$ , and  $R$  for  $t \geq 0$ .
  - Derive the expression for the value of  $t$  when the magnitude of  $v_o$  is maximum.



- 8.56** The circuit parameters in the circuit of Fig. P8.55 are  $R = 480 \Omega$ ,  $L = 8 \text{ mH}$ ,  $C = 50 \text{ nF}$ , and  $v_g = -24 \text{ V}$ .
- Express  $v_o(t)$  numerically for  $t \geq 0$ .
  - How many microseconds after the switch opens is the inductor voltage maximum?
  - What is the maximum value of the inductor voltage?
  - Repeat (a)–(c) with  $R$  reduced to  $96 \Omega$ .
- 8.57** Assume that the capacitor voltage in the circuit of Fig. 8.15 is underdamped. Also assume that no energy is stored in the circuit elements when the switch is closed.
- Show that  $dv_C/dt = (\omega_0^2/\omega_d)Ve^{-\alpha t} \sin \omega_d t$ .
  - Show that  $dv_C/dt = 0$  when  $t = n\pi/\omega_d$ , where  $n = 0, 1, 2, \dots$

- Let  $t_n = n\pi/\omega_d$ , and show that  $v_C(t_n) = V - V(-1)^n e^{-\alpha n\pi/\omega_d}$ .
- Show that

$$\alpha = \frac{1}{T_d} \ln \frac{v_C(t_1) - V}{v_C(t_3) - V},$$

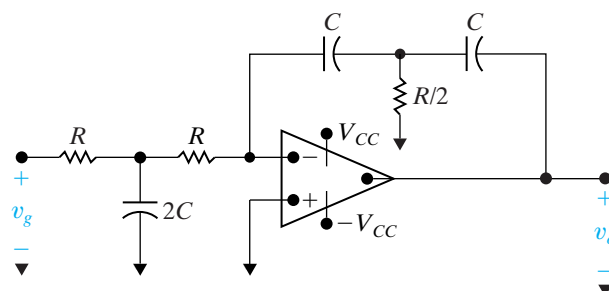
where  $T_d = t_3 - t_1$ .

- 8.58** The voltage across a  $100 \text{ nF}$  capacitor in the circuit of Fig. 8.15 is described as follows: After the switch has been closed for several seconds, the voltage is constant at  $100 \text{ V}$ . The first time the voltage exceeds  $100 \text{ V}$ , it reaches a peak of  $163.84 \text{ V}$ . This occurs  $\pi/7 \text{ ms}$  after the switch has been closed. The second time the voltage exceeds  $100 \text{ V}$ , it reaches a peak of  $126.02 \text{ V}$ . This second peak occurs  $3\pi/7$  after the switch has been closed. At the time when the switch is closed, there is no energy stored in either the capacitor or the inductor. Find the numerical values of  $R$  and  $L$ . (Hint: Work Problem 8.57 first.)

### Section 8.5

- 8.59** Show that, if no energy is stored in the circuit shown in Fig. 8.19 at the instant  $v_g$  jumps in value, then  $dv_o/dt$  equals zero at  $t = 0$ .
- 8.60** a) Find the equation for  $v_o(t)$  for  $0 \leq t \leq t_{\text{sat}}$  in the circuit shown in Fig. 8.19 if  $v_{o1}(0) = 5 \text{ V}$  and  $v_o(0) = 8 \text{ V}$ .
- How long does the circuit take to reach saturation?
- 8.61** a) Rework Example 8.14 with feedback resistors  $R_1$  and  $R_2$  removed.
- Rework Example 8.14 with  $v_{o1}(0) = -2 \text{ V}$  and  $v_o(0) = 4 \text{ V}$ .
- 8.62** a) Derive the differential equation that relates the output voltage to the input voltage for the circuit shown in Fig. P8.62.
- Compare the result with Eq. 8.75 when  $R_1 C_1 = R_2 C_2 = RC$  in Fig. 8.18.
  - What is the advantage of the circuit shown in Fig. P8.62?

**Figure P8.62**



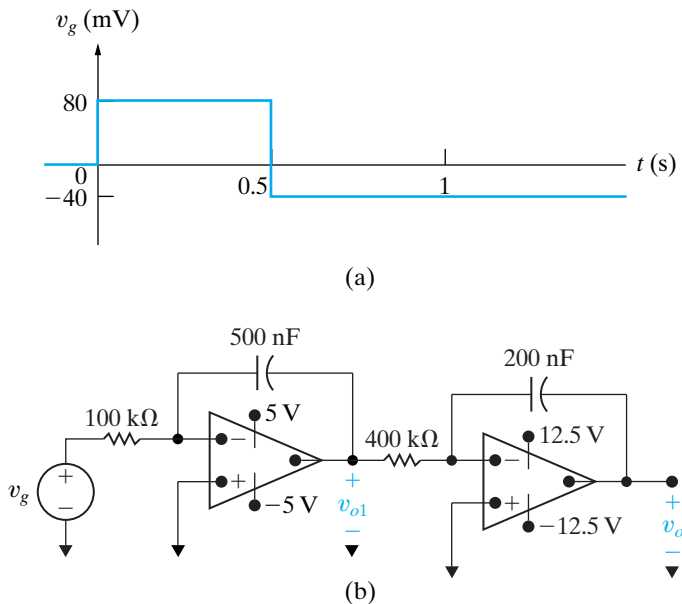


**8.63** The voltage signal of Fig. P8.63(a) is applied to the cascaded integrating amplifiers shown in Fig. P8.63(b). There is no energy stored in the capacitors at the instant the signal is applied.

PSPICE  
MULTISIM

- Derive the numerical expressions for  $v_o(t)$  and  $v_{o1}(t)$  for the time intervals  $0 \leq t \leq 0.5$  s and  $0.5 \text{ s} \leq t \leq t_{sat}$ .
- Compute the value of  $t_{sat}$ .

Figure P8.63



**8.64** The circuit in Fig. P8.63(b) is modified by adding a  $1 \text{ M}\Omega$  resistor in parallel with the  $500 \text{ nF}$  capacitor and a  $5 \text{ M}\Omega$  resistor in parallel with the  $200 \text{ nF}$  capacitor. As in Problem 8.63, there is no energy stored in the capacitors at the time the signal is applied. Derive the numerical expressions for  $v_o(t)$  and  $v_{o1}(t)$  for the time intervals  $0 \leq t \leq 0.5$  s and  $t \geq 0.5$  s.

PSPICE  
MULTISIM

**8.65** We now wish to illustrate how several op amp circuits can be interconnected to solve a differential equation.

- Derive the differential equation for the spring-mass system shown in Fig. P8.65(a). Assume that the force exerted by the spring is directly

proportional to the spring displacement, that the mass is constant, and that the frictional force is directly proportional to the velocity of the moving mass.

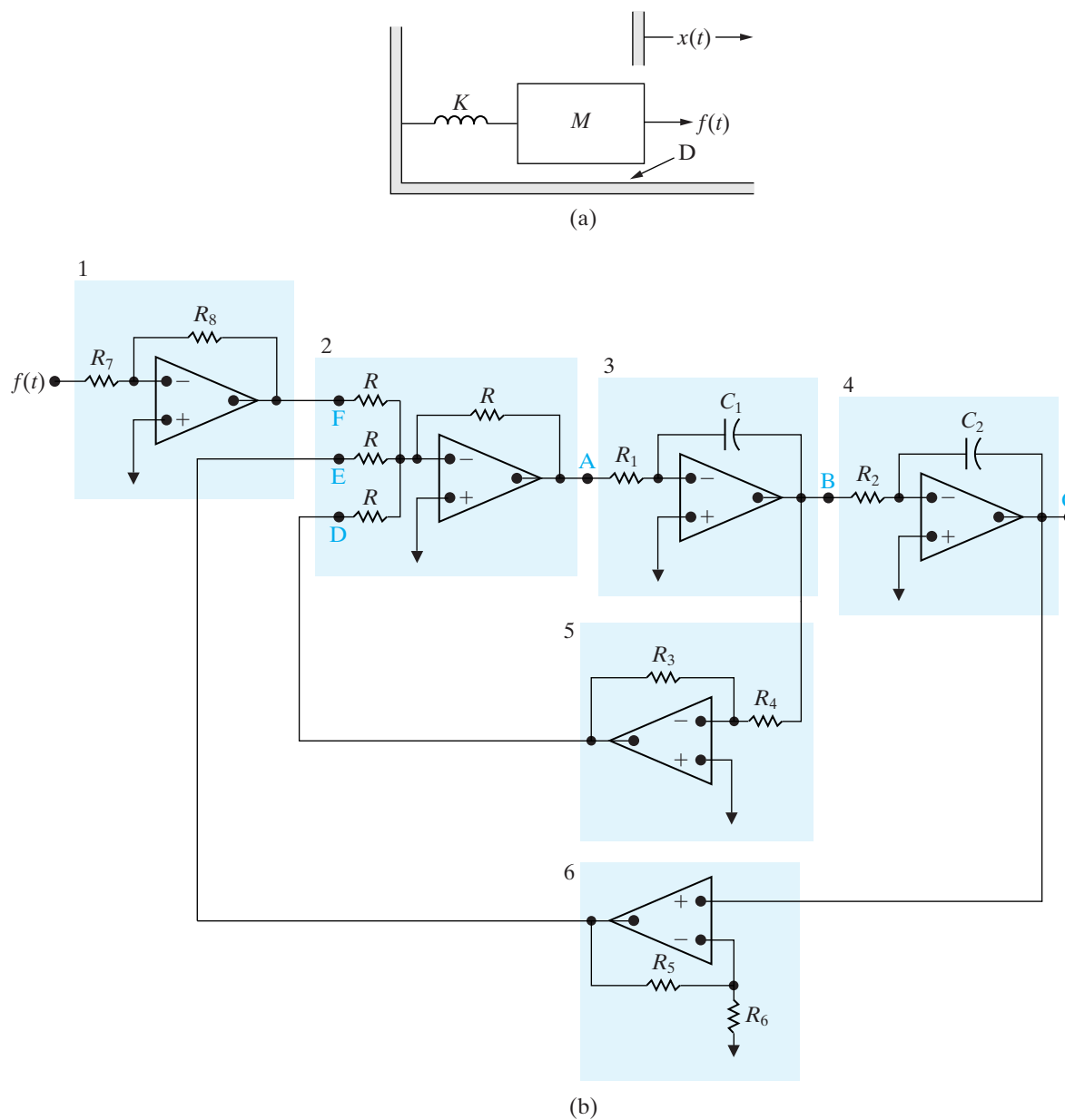
- Rewrite the differential equation derived in (a) so that the highest order derivative is expressed as a function of all the other terms in the equation. Now assume that a voltage equal to  $d^2x/dt^2$  is available and by successive integrations generates  $dx/dt$  and  $x$ . We can synthesize the coefficients in the equations by scaling amplifiers, and we can combine the terms required to generate  $d^2x/dt^2$  by using a summing amplifier. With these ideas in mind, analyze the interconnection shown in Fig. P8.65(b). In particular, describe the purpose of each shaded area in the circuit and describe the signal at the points labeled B, C, D, E, and F, assuming the signal at A represents  $d^2x/dt^2$ . Also discuss the parameters  $R$ ;  $R_1$ ,  $C_1$ ;  $R_2$ ,  $C_2$ ;  $R_3$ ,  $R_4$ ;  $R_5$ ,  $R_6$ ; and  $R_7$ ,  $R_8$  in terms of the coefficients in the differential equation.

### Sections 8.1–8.5

- 8.66**
- Suppose the circuit in Fig. 8.21 has a  $5 \text{ nH}$  inductor and a  $2 \text{ pF}$  capacitor. Calculate the frequency, in GHz, of the sinusoidal output for  $t \geq 0$ .
  - The dc voltage source and series-connected resistor in Fig. 8.21 are used to establish the initial energy in the inductor. If  $V = 10 \text{ V}$  and  $R = 25 \Omega$ , calculate the initial energy stored in the inductor.
  - What is the total energy stored in the  $LC$  circuit for any time  $t \geq 0$ ?
- 8.67** Consider the  $LC$  oscillator circuit in Fig. 8.21. Assume that  $V = 4 \text{ V}$ ,  $R = 10 \Omega$ , and  $L = 1 \text{ nH}$ .
- Calculate the value of capacitance,  $C$ , that will produce a sinusoidal output with a frequency of  $2 \text{ GHz}$  for  $t \geq 0$ .
  - Write the expression for the output voltage,  $v_o(t)$ , for  $t \geq 0$ .



Figure P8.65



**8.68** Suppose the inductor and capacitor in the  $LC$  oscillator circuit in Fig. 8.21 are not ideal, but instead have some small resistance that can be lumped together. Assume that  $V = 10$  V,  $R = 25$   $\Omega$ ,  $L = 5$  nH, and  $C = 2$  pF, just as in Problem 8.66. Suppose the resistance associated with the inductor and capacitor is  $10$  m $\Omega$ .

a) Calculate the values of the neper frequency,  $\alpha$ , and the resonant radian frequency,  $\omega_0$ .

b) Is the response of this circuit over-, under-, or critically damped?

c) What is the actual frequency of oscillation, in GHz?

d) Approximately how long will the circuit oscillate?

# Sinusoidal Steady-State Analysis

## CHAPTER CONTENTS

- 9.1 The Sinusoidal Source *p.* 306
- 9.2 The Sinusoidal Response *p.* 309
- 9.3 The Phasor *p.* 310
- 9.4 The Passive Circuit Elements in the Frequency Domain *p.* 315
- 9.5 Kirchhoff's Laws in the Frequency Domain *p.* 319
- 9.6 Series, Parallel, and Delta-to-Wye Simplifications *p.* 320
- 9.7 Source Transformations and Thévenin-Norton Equivalent Circuits *p.* 327
- 9.8 The Node-Voltage Method *p.* 330
- 9.9 The Mesh-Current Method *p.* 331
- 9.10 The Transformer *p.* 332
- 9.11 The Ideal Transformer *p.* 336
- 9.12 Phasor Diagrams *p.* 342

## ✓ CHAPTER OBJECTIVES

- 1 Understand phasor concepts and be able to perform a phasor transform and an inverse phasor transform.
- 2 Be able to transform a circuit with a sinusoidal source into the frequency domain using phasor concepts.
- 3 Know how to use the following circuit analysis techniques to solve a circuit in the frequency domain:
  - Kirchhoff's laws;
  - Series, parallel, and delta-to-wye simplifications;
  - Voltage and current division;
  - Thévenin and Norton equivalents;
  - Node-voltage method; and
  - Mesh-current method.
- 4 Be able to analyze circuits containing linear transformers using phasor methods.
- 5 Understand the ideal transformer constraints and be able to analyze circuits containing ideal transformers using phasor methods.

**Thus far, we have focused** on circuits with constant sources; in this chapter we are now ready to consider circuits energized by time-varying voltage or current sources. In particular, we are interested in sources in which the value of the voltage or current varies sinusoidally. Sinusoidal sources and their effect on circuit behavior form an important area of study for several reasons. First, the generation, transmission, distribution, and consumption of electric energy occur under essentially sinusoidal steady-state conditions. Second, an understanding of sinusoidal behavior makes it possible to predict the behavior of circuits with nonsinusoidal sources. Third, steady-state sinusoidal behavior often simplifies the design of electrical systems. Thus a designer can spell out specifications in terms of a desired steady-state sinusoidal response and design the circuit or system to meet those characteristics. If the device satisfies the specifications, the designer knows that the circuit will respond satisfactorily to nonsinusoidal inputs.

The subsequent chapters of this book are largely based on a thorough understanding of the techniques needed to analyze circuits driven by sinusoidal sources. Fortunately, the circuit analysis and simplification techniques first introduced in Chapters 1–4 work for circuits with sinusoidal as well as dc sources, so some of the material in this chapter will be very familiar to you. The challenges in first approaching sinusoidal analysis include developing the appropriate modeling equations and working in the mathematical realm of complex numbers.

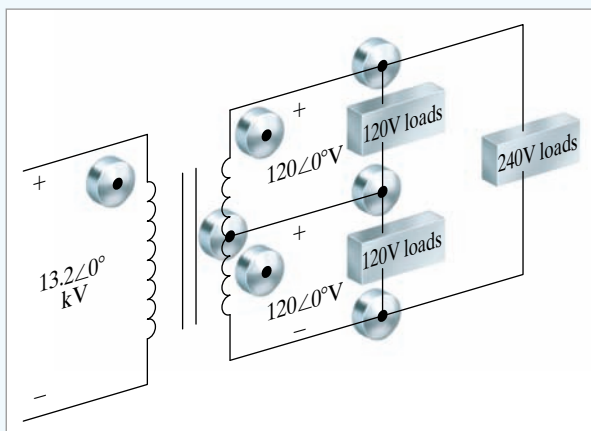
## Practical Perspective

### A Household Distribution Circuit

Power systems that generate, transmit, and distribute electrical power are designed to operate in the sinusoidal steady state. The standard household distribution circuit used in the United States is the three-wire, 240/120 V circuit shown in the accompanying figure.

The transformer is used to reduce the utility distribution voltage from 13.2 kV to 240 V. The center tap on the secondary winding provides the 120 V service. The operating frequency of power systems in the United States is 60 Hz. Both 50 and 60 Hz systems are found outside the United States.

The voltage ratings alluded to above are rms values. The reason for defining an rms value of a time-varying signal is explained in Chapter 10.



Steve Cole / Photodisc / Getty Images, Inc.

## 9.1 The Sinusoidal Source

A **sinusoidal voltage source** (independent or dependent) produces a voltage that varies sinusoidally with time. A **sinusoidal current source** (independent or dependent) produces a current that varies sinusoidally with time. In reviewing the sinusoidal function, we use a voltage source, but our observations also apply to current sources.

We can express a sinusoidally varying function with either the sine function or the cosine function. Although either works equally well, we cannot use both functional forms simultaneously. We will use the cosine function throughout our discussion. Hence, we write a sinusoidally varying voltage as

$$v = V_m \cos(\omega t + \phi). \quad (9.1)$$

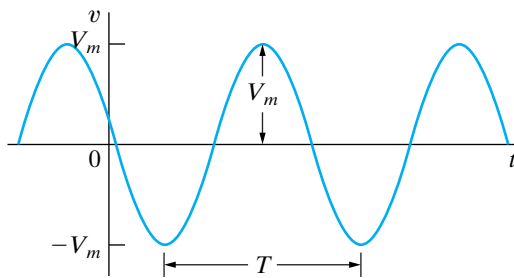


Figure 9.1 ▲ A sinusoidal voltage.

To aid discussion of the parameters in Eq. 9.1, we show the voltage versus time plot in Fig. 9.1.

Note that the sinusoidal function repeats at regular intervals. Such a function is called periodic. One parameter of interest is the length of time required for the sinusoidal function to pass through all its possible values. This time is referred to as the **period** of the function and is denoted  $T$ . It is measured in seconds. The reciprocal of  $T$  gives the number of cycles per second, or the frequency, of the sine function and is denoted  $f$ , or

$$f = \frac{1}{T}. \quad (9.2)$$

A cycle per second is referred to as a hertz, abbreviated Hz. (The term *cycles per second* rarely is used in contemporary technical literature.) The coefficient of  $t$  in Eq. 9.1 contains the numerical value of  $T$  or  $f$ . Omega ( $\omega$ ) represents the angular frequency of the sinusoidal function, or

$$\omega = 2\pi f = 2\pi/T \text{ (radians/second)}. \quad (9.3)$$

Equation 9.3 is based on the fact that the cosine (or sine) function passes through a complete set of values each time its argument,  $\omega t$ , passes through  $2\pi$  rad ( $360^\circ$ ). From Eq. 9.3, note that, whenever  $t$  is an integral multiple of  $T$ , the argument  $\omega t$  increases by an integral multiple of  $2\pi$  rad.

The coefficient  $V_m$  gives the maximum amplitude of the sinusoidal voltage. Because  $\pm 1$  bounds the cosine function,  $\pm V_m$  bounds the amplitude. Figure 9.1 shows these characteristics.

The angle  $\phi$  in Eq. 9.1 is known as the **phase angle** of the sinusoidal voltage. It determines the value of the sinusoidal function at  $t = 0$ ; therefore, it fixes the point on the periodic wave at which we start measuring time. Changing the phase angle  $\phi$  shifts the sinusoidal function along the time axis but has no effect on either the amplitude ( $V_m$ ) or the angular frequency ( $\omega$ ). Note, for example, that reducing  $\phi$  to zero shifts the sinusoidal function shown in Fig. 9.1  $\phi/\omega$  time units to the right, as shown in Fig. 9.2. Note also that if  $\phi$  is positive, the sinusoidal function shifts to the left, whereas if  $\phi$  is negative, the function shifts to the right. (See Problem 9.5.)

A comment with regard to the phase angle is in order:  $\omega t$  and  $\phi$  must carry the same units, because they are added together in the argument of the sinusoidal function. With  $\omega t$  expressed in radians, you would expect  $\phi$  to be also. However,  $\phi$  normally is given in degrees, and  $\omega t$  is converted from radians to degrees before the two quantities are added. We continue

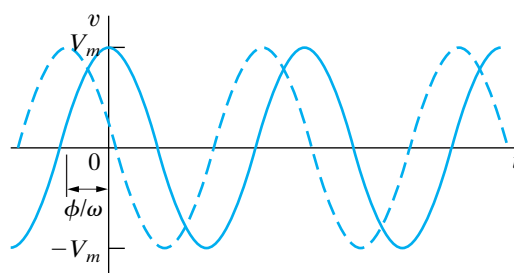


Figure 9.2 ▲ The sinusoidal voltage from Fig. 9.1 shifted to the right when  $\phi = 0$ .

this bias toward degrees by expressing the phase angle in degrees. Recall from your studies of trigonometry that the conversion from radians to degrees is given by

$$(\text{number of degrees}) = \frac{180^\circ}{\pi} (\text{number of radians}). \quad (9.4)$$

Another important characteristic of the sinusoidal voltage (or current) is its **rms value**. The rms value of a periodic function is defined as the square root of the mean value of the squared function. Hence, if  $v = V_m \cos(\omega t + \phi)$ , the rms value of  $v$  is

$$V_{\text{rms}} = \sqrt{\frac{1}{T} \int_{t_0}^{t_0+T} V_m^2 \cos^2(\omega t + \phi) dt}. \quad (9.5)$$

Note from Eq. 9.5 that we obtain the mean value of the squared voltage by integrating  $v^2$  over one period (that is, from  $t_0$  to  $t_0 + T$ ) and then dividing by the range of integration,  $T$ . Note further that the starting point for the integration  $t_0$  is arbitrary.

The quantity under the radical sign in Eq. 9.5 reduces to  $V_m^2/2$ . (See Problem 9.6.) Hence the rms value of  $v$  is

$$V_{\text{rms}} = \frac{V_m}{\sqrt{2}}. \quad (9.6) \quad \blacktriangleleft \text{rms value of a sinusoidal voltage source}$$

The rms value of the sinusoidal voltage depends only on the maximum amplitude of  $v$ , namely,  $V_m$ . The rms value is not a function of either the frequency or the phase angle. We stress the importance of the rms value as it relates to power calculations in Chapter 10 (see Section 10.3).

Thus, we can completely describe a specific sinusoidal signal if we know its frequency, phase angle, and amplitude (either the maximum or the rms value). Examples 9.1, 9.2, and 9.3 illustrate these basic properties of the sinusoidal function. In Example 9.4, we calculate the rms value of a periodic function, and in so doing we clarify the meaning of *root mean square*.

### Example 9.1 Finding the Characteristics of a Sinusoidal Current

A sinusoidal current has a maximum amplitude of 20 A. The current passes through one complete cycle in 1 ms. The magnitude of the current at zero time is 10 A.

- What is the frequency of the current in hertz?
- What is the frequency in radians per second?
- Write the expression for  $i(t)$  using the cosine function. Express  $\phi$  in degrees.
- What is the rms value of the current?

#### Solution

- From the statement of the problem,  $T = 1$  ms; hence  $f = 1/T = 1000$  Hz.
- $\omega = 2\pi f = 2000\pi$  rad/s.
- We have  $i(t) = I_m \cos(\omega t + \phi) = 20 \cos(2000\pi t + \phi)$ , but  $i(0) = 10$  A. Therefore  $10 = 20 \cos \phi$  and  $\phi = 60^\circ$ . Thus the expression for  $i(t)$  becomes
 
$$i(t) = 20 \cos(2000\pi t + 60^\circ).$$
- From the derivation of Eq. 9.6, the rms value of a sinusoidal current is  $I_m/\sqrt{2}$ . Therefore the rms value is  $20/\sqrt{2}$ , or 14.14 A.

**Example 9.2** Finding the Characteristics of a Sinusoidal Voltage

A sinusoidal voltage is given by the expression  $v = 300 \cos(120\pi t + 30^\circ)$ .

- What is the period of the voltage in milliseconds?
- What is the frequency in hertz?
- What is the magnitude of  $v$  at  $t = 2.778$  ms?
- What is the rms value of  $v$ ?

**Solution**

- From the expression for  $v$ ,  $\omega = 120\pi$  rad/s. Because  $\omega = 2\pi/T$ ,  $T = 2\pi/\omega = \frac{1}{60}$  s, or 16.667 ms.
- The frequency is  $1/T$ , or 60 Hz.
- From (a),  $\omega = 2\pi/16.667$ ; thus, at  $t = 2.778$  ms,  $\omega t$  is nearly 1.047 rad, or  $60^\circ$ . Therefore,  $v(2.778 \text{ ms}) = 300 \cos(60^\circ + 30^\circ) = 0$  V.
- $V_{\text{rms}} = 300/\sqrt{2} = 212.13$  V.

**Example 9.3** Translating a Sine Expression to a Cosine Expression

We can translate the sine function to the cosine function by subtracting  $90^\circ$  ( $\pi/2$  rad) from the argument of the sine function.

- Verify this translation by showing that

$$\sin(\omega t + \theta) = \cos(\omega t + \theta - 90^\circ).$$

- Use the result in (a) to express  $\sin(\omega t + 30^\circ)$  as a cosine function.

**Solution**

- Verification involves direct application of the trigonometric identity

$$\cos(\alpha - \beta) = \cos \alpha \cos \beta + \sin \alpha \sin \beta.$$

We let  $\alpha = \omega t + \theta$  and  $\beta = 90^\circ$ . As  $\cos 90^\circ = 0$  and  $\sin 90^\circ = 1$ , we have

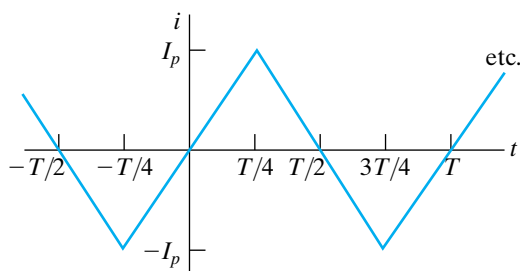
$$\cos(\alpha - \beta) = \sin \alpha = \sin(\omega t + \theta) = \cos(\omega t + \theta - 90^\circ).$$

- From (a) we have

$$\sin(\omega t + 30^\circ) = \cos(\omega t + 30^\circ - 90^\circ) = \cos(\omega t - 60^\circ).$$

**Example 9.4** Calculating the rms Value of a Triangular Waveform

Calculate the rms value of the periodic triangular current shown in Fig. 9.3. Express your answer in terms of the peak current  $I_p$ .



**Figure 9.3** ▲ Periodic triangular current.

**Solution**

From Eq. 9.5, the rms value of  $i$  is

$$I_{\text{rms}} = \sqrt{\frac{1}{T} \int_{t_0}^{t_0+T} i^2 dt}.$$

Interpreting the integral under the radical sign as the area under the squared function for an interval of one period is helpful in finding the rms value. The squared function with the area between 0 and  $T$  shaded is shown in Fig. 9.4, which also indicates that for this particular function, the area under the

squared current for an interval of one period is equal to four times the area under the squared current for the interval 0 to  $T/4$  seconds; that is,

$$\int_{t_0}^{t_0+T} i^2 dt = 4 \int_0^{T/4} i^2 dt.$$

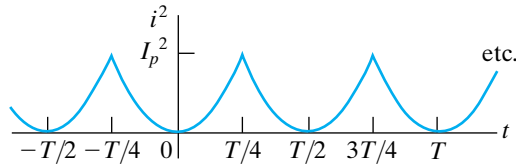


Figure 9.4 ▲  $i^2$  versus  $t$ .

The analytical expression for  $i$  in the interval 0 to  $T/4$  is

$$i = \frac{4I_p}{T}t, \quad 0 < t < T/4.$$

NOTE: Assess your understanding of this material by trying Chapter Problems 9.1, 9.3 and 9.7.

The area under the squared function for one period is

$$\int_{t_0}^{t_0+T} i^2 dt = 4 \int_0^{T/4} \frac{16I_p^2}{T^2} t^2 dt = \frac{I_p^2 T}{3}.$$

The mean, or average, value of the function is simply the area for one period divided by the period. Thus

$$i_{\text{mean}} = \frac{1}{T} \frac{I_p^2 T}{3} = \frac{1}{3} I_p^2.$$

The rms value of the current is the square root of this mean value. Hence

$$I_{\text{rms}} = \frac{I_p}{\sqrt{3}}.$$

## 9.2 The Sinusoidal Response

Before focusing on the steady-state response to sinusoidal sources, let's consider the problem in broader terms, that is, in terms of the total response. Such an overview will help you keep the steady-state solution in perspective. The circuit shown in Fig. 9.5 describes the general nature of the problem. There,  $v_s$  is a sinusoidal voltage, or

$$v_s = V_m \cos(\omega t + \phi). \quad (9.7)$$

For convenience, we assume the initial current in the circuit to be zero and measure time from the moment the switch is closed. The task is to derive the expression for  $i(t)$  when  $t \geq 0$ . It is similar to finding the step response of an  $RL$  circuit, as in Chapter 7. The only difference is that the voltage source is now a time-varying sinusoidal voltage rather than a constant, or dc, voltage. Direct application of Kirchhoff's voltage law to the circuit shown in Fig. 9.5 leads to the ordinary differential equation

$$L \frac{di}{dt} + Ri = V_m \cos(\omega t + \phi), \quad (9.8)$$

the formal solution of which is discussed in an introductory course in differential equations. We ask those of you who have not yet studied differential equations to accept that the solution for  $i$  is

$$i = \frac{-V_m}{\sqrt{R^2 + \omega^2 L^2}} \cos(\phi - \theta) e^{-(R/L)t} + \frac{V_m}{\sqrt{R^2 + \omega^2 L^2}} \cos(\omega t + \phi - \theta), \quad (9.9)$$

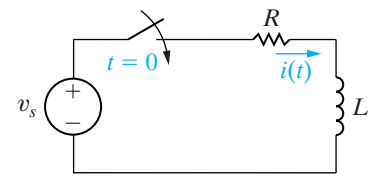


Figure 9.5 ▲ An  $RL$  circuit excited by a sinusoidal voltage source.



where  $\theta$  is defined as the angle whose tangent is  $\omega L/R$ . Thus we can easily determine  $\theta$  for a circuit driven by a sinusoidal source of known frequency.

We can check the validity of Eq. 9.9 by determining that it satisfies Eq. 9.8 for all values of  $t \geq 0$ ; this exercise is left for your exploration in Problem 9.10.

The first term on the right-hand side of Eq. 9.9 is referred to as the **transient component** of the current because it becomes infinitesimal as time elapses. The second term on the right-hand side is known as the **steady-state component** of the solution. It exists as long as the switch remains closed and the source continues to supply the sinusoidal voltage. In this chapter, we develop a technique for calculating the steady-state response directly, thus avoiding the problem of solving the differential equation. However, in using this technique we forfeit obtaining either the transient component or the total response, which is the sum of the transient and steady-state components.

We now focus on the steady-state portion of Eq. 9.9. It is important to remember the following characteristics of the steady-state solution:

1. The steady-state solution is a sinusoidal function.
2. The frequency of the response signal is identical to the frequency of the source signal. This condition is always true in a linear circuit when the circuit parameters, R, L, and C, are constant. (If frequencies in the response signals are not present in the source signals, there is a nonlinear element in the circuit.)
3. The maximum amplitude of the steady-state response, in general, differs from the maximum amplitude of the source. For the circuit being discussed, the maximum amplitude of the response signal is  $V_m/\sqrt{R^2 + \omega^2 L^2}$ , and the maximum amplitude of the signal source is  $V_m$ .
4. The phase angle of the response signal, in general, differs from the phase angle of the source. For the circuit being discussed, the phase angle of the current is  $\phi - \theta$  and that of the voltage source is  $\phi$ .

These characteristics are worth remembering because they help you understand the motivation for the phasor method, which we introduce in Section 9.3. In particular, note that once the decision has been made to find only the steady-state response, the task is reduced to finding the maximum amplitude and phase angle of the response signal. The waveform and frequency of the response are already known.

*NOTE: Assess your understanding of this material by trying Chapter Problem 9.9.*

## 9.3 The Phasor

The **phasor** is a complex number that carries the amplitude and phase angle information of a sinusoidal function.<sup>1</sup> The phasor concept is rooted in Euler's identity, which relates the exponential function to the trigonometric function:

$$e^{\pm j\theta} = \cos \theta \pm j \sin \theta. \quad (9.10)$$

Equation 9.10 is important here because it gives us another way of expressing the cosine and sine functions. We can think of the cosine function as the

<sup>1</sup> If you feel a bit uneasy about complex numbers, peruse Appendix B.

real part of the exponential function and the sine function as the imaginary part of the exponential function; that is,

$$\cos \theta = \Re \{e^{j\theta}\}, \quad (9.11)$$

and

$$\sin \theta = \Im \{e^{j\theta}\}, \quad (9.12)$$

where  $\Re$  means “the real part of” and  $\Im$  means “the imaginary part of.”

Because we have already chosen to use the cosine function in analyzing the sinusoidal steady state (see Section 9.1), we can apply Eq. 9.11 directly. In particular, we write the sinusoidal voltage function given by Eq. 9.1 in the form suggested by Eq. 9.11:

$$\begin{aligned} v &= V_m \cos(\omega t + \phi) \\ &= V_m \Re \{e^{j(\omega t + \phi)}\} \\ &= V_m \Re \{e^{j\omega t} e^{j\phi}\}. \end{aligned} \quad (9.13)$$

We can move the coefficient  $V_m$  inside the argument of the real part of the function without altering the result. We can also reverse the order of the two exponential functions inside the argument and write Eq. 9.13 as

$$v = \Re \{V_m e^{j\phi} e^{j\omega t}\}. \quad (9.14)$$

In Eq. 9.14, note that the quantity  $V_m e^{j\phi}$  is a complex number that carries the amplitude and phase angle of the given sinusoidal function. This complex number is by definition the **phasor representation**, or **phasor transform**, of the given sinusoidal function. Thus

$$\mathbf{V} = V_m e^{j\phi} = \mathcal{P}\{V_m \cos(\omega t + \phi)\}, \quad (9.15) \quad \blacktriangleleft \text{Phasor transform}$$

where the notation  $\mathcal{P}\{V_m \cos(\omega t + \phi)\}$  is read “the phasor transform of  $V_m \cos(\omega t + \phi)$ .” Thus the phasor transform transfers the sinusoidal function from the time domain to the complex-number domain, which is also called the **frequency domain**, since the response depends, in general, on  $\omega$ . As in Eq. 9.15, throughout this book we represent a phasor quantity by using a boldface letter.

Equation 9.15 is the polar form of a phasor, but we also can express a phasor in rectangular form. Thus we rewrite Eq. 9.15 as

$$\mathbf{V} = V_m \cos \phi + jV_m \sin \phi. \quad (9.16)$$

Both polar and rectangular forms are useful in circuit applications of the phasor concept.

One additional comment regarding Eq. 9.15 is in order. The frequent occurrence of the exponential function  $e^{j\phi}$  has led to an abbreviation that lends itself to text material. This abbreviation is the angle notation

$$1/\underline{\phi}^\circ \equiv 1e^{j\phi}.$$

We use this notation extensively in the material that follows.

## Inverse Phasor Transform

So far we have emphasized moving from the sinusoidal function to its phasor transform. However, we may also reverse the process. That is, for a phasor we may write the expression for the sinusoidal function. Thus for  $\mathbf{V} = 100\angle -26^\circ$ , the expression for  $v$  is  $100 \cos(\omega t - 26^\circ)$  because we have decided to use the cosine function for all sinusoids. Observe that we cannot deduce the value of  $\omega$  from the phasor. The phasor carries only amplitude and phase information. The step of going from the phasor transform to the time-domain expression is referred to as *finding the inverse phasor transform* and is formalized by the equation

$$\mathcal{P}^{-1}\{V_m e^{j\phi}\} = \Re\{V_m e^{j\phi} e^{j\omega t}\}, \quad (9.17)$$

where the notation  $\mathcal{P}^{-1}\{V_m e^{j\phi}\}$  is read as “the inverse phasor transform of  $V_m e^{j\phi}$ .” Equation 9.17 indicates that to find the inverse phasor transform, we multiply the phasor by  $e^{j\omega t}$  and then extract the real part of the product.

The phasor transform is useful in circuit analysis because it reduces the task of finding the maximum amplitude and phase angle of the steady-state sinusoidal response to the algebra of complex numbers. The following observations verify this conclusion:

1. The transient component vanishes as time elapses, so the steady-state component of the solution must also satisfy the differential equation. (See Problem 9.10[b].)
2. In a linear circuit driven by sinusoidal sources, the steady-state response also is sinusoidal, and the frequency of the sinusoidal response is the same as the frequency of the sinusoidal source.
3. Using the notation introduced in Eq. 9.11, we can postulate that the steady-state solution is of the form  $\Re\{A e^{j\beta} e^{j\omega t}\}$ , where  $A$  is the maximum amplitude of the response and  $\beta$  is the phase angle of the response.
4. When we substitute the postulated steady-state solution into the differential equation, the exponential term  $e^{j\omega t}$  cancels out, leaving the solution for  $A$  and  $\beta$  in the domain of complex numbers.

We illustrate these observations with the circuit shown in Fig. 9.5 (see p. 309). We know that the steady-state solution for the current  $i$  is of the form

$$i_{\text{ss}}(t) = \Re\{I_m e^{j\beta} e^{j\omega t}\}, \quad (9.18)$$

where the subscript “ss” emphasizes that we are dealing with the steady-state solution. When we substitute Eq. 9.18 into Eq. 9.8, we generate the expression

$$\Re\{j\omega L I_m e^{j\beta} e^{j\omega t}\} + \Re\{R I_m e^{j\beta} e^{j\omega t}\} = \Re\{V_m e^{j\phi} e^{j\omega t}\}. \quad (9.19)$$

In deriving Eq. 9.19 we recognized that both differentiation and multiplication by a constant can be taken inside the real part of an operation. We also rewrote the right-hand side of Eq. 9.8, using the notation of Eq. 9.11. From

the algebra of complex numbers, we know that the sum of the real parts is the same as the real part of the sum. Therefore we may reduce the left-hand side of Eq. 9.19 to a single term:

$$\Re\{(j\omega L + R)I_m e^{j\beta} e^{j\omega t}\} = \Re\{V_m e^{j\phi} e^{j\omega t}\}. \quad (9.20)$$

Recall that our decision to use the cosine function in analyzing the response of a circuit in the sinusoidal steady state results in the use of the  $\Re$  operator in deriving Eq. 9.20. If instead we had chosen to use the sine function in our sinusoidal steady-state analysis, we would have applied Eq. 9.12 directly, in place of Eq. 9.11, and the result would be Eq. 9.21:

$$\Im\{(j\omega L + R)I_m e^{j\beta} e^{j\omega t}\} = \Im\{V_m e^{j\phi} e^{j\omega t}\}. \quad (9.21)$$

Note that the complex quantities on either side of Eq. 9.21 are identical to those on either side of Eq. 9.20. When both the real and imaginary parts of two complex quantities are equal, then the complex quantities are themselves equal. Therefore, from Eqs. 9.20 and 9.21,

$$(j\omega L + R)I_m e^{j\beta} = V_m e^{j\phi},$$

or

$$I_m e^{j\beta} = \frac{V_m e^{j\phi}}{R + j\omega L}. \quad (9.22)$$

Note that  $e^{j\omega t}$  has been eliminated from the determination of the amplitude ( $I_m$ ) and phase angle ( $\beta$ ) of the response. Thus, for this circuit, the task of finding  $I_m$  and  $\beta$  involves the algebraic manipulation of the complex quantities  $V_m e^{j\phi}$  and  $R + j\omega L$ . Note that we encountered both polar and rectangular forms.

An important warning is in order: The phasor transform, along with the inverse phasor transform, allows you to go back and forth between the time domain and the frequency domain. Therefore, when you obtain a solution, you are either in the time domain or the frequency domain. You cannot be in both domains simultaneously. Any solution that contains a mixture of time domain and phasor domain nomenclature is nonsensical.

The phasor transform is also useful in circuit analysis because it applies directly to the sum of sinusoidal functions. Circuit analysis involves summing currents and voltages, so the importance of this observation is obvious. We can formalize this property as follows: If

$$v = v_1 + v_2 + \cdots + v_n \quad (9.23)$$

where all the voltages on the right-hand side are sinusoidal voltages of the same frequency, then

$$\mathbf{V} = \mathbf{V}_1 + \mathbf{V}_2 + \cdots + \mathbf{V}_n. \quad (9.24)$$

Thus the phasor representation is the sum of the phasors of the individual terms. We discuss the development of Eq. 9.24 in Section 9.5.

Before applying the phasor transform to circuit analysis, we illustrate its usefulness in solving a problem with which you are already familiar: adding sinusoidal functions via trigonometric identities. Example 9.5 shows how the phasor transform greatly simplifies this type of problem.

### Example 9.5 Adding Cosines Using Phasors

If  $y_1 = 20 \cos(\omega t - 30^\circ)$  and  $y_2 = 40 \cos(\omega t + 60^\circ)$ , express  $y = y_1 + y_2$  as a single sinusoidal function.

- Solve by using trigonometric identities.
- Solve by using the phasor concept.

#### Solution

- First we expand both  $y_1$  and  $y_2$ , using the cosine of the sum of two angles, to get

$$y_1 = 20 \cos \omega t \cos 30^\circ + 20 \sin \omega t \sin 30^\circ;$$

$$y_2 = 40 \cos \omega t \cos 60^\circ - 40 \sin \omega t \sin 60^\circ.$$

Adding  $y_1$  and  $y_2$ , we obtain

$$\begin{aligned} y &= (20 \cos 30 + 40 \cos 60) \cos \omega t \\ &\quad + (20 \sin 30 - 40 \sin 60) \sin \omega t \\ &= 37.32 \cos \omega t - 24.64 \sin \omega t. \end{aligned}$$

To combine these two terms we treat the co-efficients of the cosine and sine as sides of a right triangle (Fig. 9.6) and then multiply and divide the right-hand side by the hypotenuse. Our expression for  $y$  becomes

$$\begin{aligned} y &= 44.72 \left( \frac{37.32}{44.72} \cos \omega t - \frac{24.64}{44.72} \sin \omega t \right) \\ &= 44.72 (\cos 33.43^\circ \cos \omega t - \sin 33.43^\circ \sin \omega t). \end{aligned}$$

Again, we invoke the identity involving the cosine of the sum of two angles and write

$$y = 44.72 \cos(\omega t + 33.43^\circ).$$

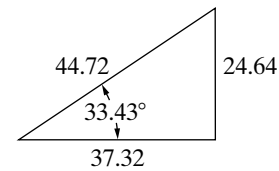


Figure 9.6 ▲ A right triangle used in the solution for  $y$ .

- We can solve the problem by using phasors as follows: Because

$$y = y_1 + y_2,$$

then, from Eq. 9.24,

$$\begin{aligned} \mathbf{Y} &= \mathbf{Y}_1 + \mathbf{Y}_2 \\ &= 20 \angle -30^\circ + 40 \angle 60^\circ \\ &= (17.32 - j10) + (20 + j34.64) \\ &= 37.32 + j24.64 \\ &= 44.72 \angle 33.43^\circ. \end{aligned}$$

Once we know the phasor  $\mathbf{Y}$ , we can write the corresponding trigonometric function for  $y$  by taking the inverse phasor transform:

$$\begin{aligned} y &= \mathcal{P}^{-1}\{44.72e^{j33.43}\} = \Re\{44.72e^{j33.43}e^{j\omega t}\} \\ &= 44.72 \cos(\omega t + 33.43^\circ). \end{aligned}$$

The superiority of the phasor approach for adding sinusoidal functions should be apparent. Note that it requires the ability to move back and forth between the polar and rectangular forms of complex numbers.

## ASSESSMENT PROBLEMS

**Objective 1—Understand phasor concepts and be able to perform a phasor transform and an inverse phasor transform**

**9.1** Find the phasor transform of each trigonometric function:

- a)  $v = 170 \cos(377t - 40^\circ)$  V.  
 b)  $i = 10 \sin(1000t + 20^\circ)$  A.  
 c)  $i = [5 \cos(\omega t + 36.87^\circ) + 10 \cos(\omega t - 53.13^\circ)]$  A.  
 d)  $v = [300 \cos(20,000\pi t + 45^\circ) - 100 \sin(20,000\pi t + 30^\circ)]$  mV.

**Answer:** (a)  $170 \angle -40^\circ$  V;  
 (b)  $10 \angle -70^\circ$  A;

- (c)  $11.18 \angle -26.57^\circ$  A;  
 (d)  $339.90 \angle 61.51^\circ$  mV.

**9.2** Find the time-domain expression corresponding to each phasor:

- a)  $\mathbf{V} = 18.6 \angle -54^\circ$  V.  
 b)  $\mathbf{I} = (20 \angle 45^\circ - 50 \angle -30^\circ)$  mA.  
 c)  $\mathbf{V} = (20 + j80 - 30 \angle 15^\circ)$  V.

**Answer:** (a)  $18.6 \cos(\omega t - 54^\circ)$  V;  
 (b)  $48.81 \cos(\omega t + 126.68^\circ)$  mA;  
 (c)  $72.79 \cos(\omega t + 97.08^\circ)$  V.

*NOTE: Also try Chapter Problem 9.11.*

## 9.4 The Passive Circuit Elements in the Frequency Domain

The systematic application of the phasor transform in circuit analysis requires two steps. First, we must establish the relationship between the phasor current and the phasor voltage at the terminals of the passive circuit elements. Second, we must develop the phasor-domain version of Kirchhoff's laws, which we discuss in Section 9.5. In this section, we establish the relationship between the phasor current and voltage at the terminals of the resistor, inductor, and capacitor. We begin with the resistor and use the passive sign convention in all the derivations.

### The V-I Relationship for a Resistor

From Ohm's law, if the current in a resistor varies sinusoidally with time—that is, if  $i = I_m \cos(\omega t + \theta_i)$ —the voltage at the terminals of the resistor, as shown in Fig. 9.7, is

$$\begin{aligned} v &= R[I_m \cos(\omega t + \theta_i)] \\ &= RI_m[\cos(\omega t + \theta_i)], \end{aligned} \quad (9.25)$$

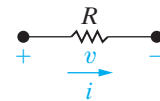
where  $I_m$  is the maximum amplitude of the current in amperes and  $\theta_i$  is the phase angle of the current.

The phasor transform of this voltage is

$$\mathbf{V} = RI_m e^{j\theta_i} = RI_m \angle \theta_i. \quad (9.26)$$

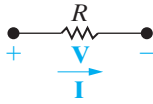
But  $I_m \angle \theta_i$  is the phasor representation of the sinusoidal current, so we can write Eq. 9.26 as

$$\mathbf{V} = R\mathbf{I}, \quad (9.27)$$

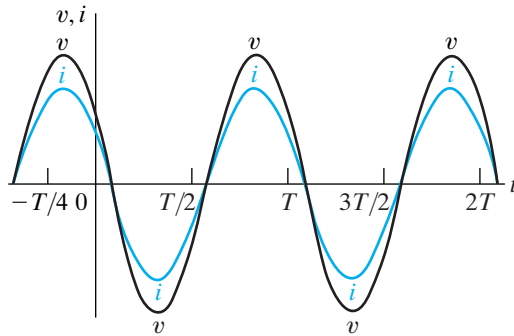


**Figure 9.7** ▲ A resistive element carrying a sinusoidal current.

◀ **Relationship between phasor voltage and phasor current for a resistor**



**Figure 9.8** ▲ The frequency-domain equivalent circuit of a resistor.



**Figure 9.9** ▲ A plot showing that the voltage and current at the terminals of a resistor are in phase.

which states that the phasor voltage at the terminals of a resistor is simply the resistance times the phasor current. Figure 9.8 shows the circuit diagram for a resistor in the frequency domain.

Equations 9.25 and 9.27 both contain another important piece of information—namely, that at the terminals of a resistor, there is no phase shift between the current and voltage. Figure 9.9 depicts this phase relationship, where the phase angle of both the voltage and the current waveforms is  $60^\circ$ . The signals are said to be **in phase** because they both reach corresponding values on their respective curves at the same time (for example, they are at their positive maxima at the same instant).

### The V-I Relationship for an Inductor

We derive the relationship between the phasor current and phasor voltage at the terminals of an inductor by assuming a sinusoidal current and using  $Ldi/dt$  to establish the corresponding voltage. Thus, for  $i = I_m \cos(\omega t + \theta_i)$ , the expression for the voltage is

$$v = L \frac{di}{dt} = -\omega L I_m \sin(\omega t + \theta_i). \tag{9.28}$$

We now rewrite Eq. 9.28 using the cosine function:

$$v = -\omega L I_m \cos(\omega t + \theta_i - 90^\circ). \tag{9.29}$$

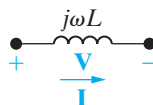
The phasor representation of the voltage given by Eq. 9.29 is

$$\begin{aligned} \mathbf{V} &= -\omega L I_m e^{j(\theta_i - 90^\circ)} \\ &= -\omega L I_m e^{j\theta_i} e^{-j90^\circ} \\ &= j\omega L I_m e^{j\theta_i} \\ &= j\omega L \mathbf{I}. \end{aligned} \tag{9.30}$$

#### Relationship between phasor voltage and phasor current for an inductor

Note that in deriving Eq. 9.30 we used the identity

$$e^{-j90^\circ} = \cos 90^\circ - j \sin 90^\circ = -j.$$



**Figure 9.10** ▲ The frequency-domain equivalent circuit for an inductor.

Equation 9.30 states that the phasor voltage at the terminals of an inductor equals  $j\omega L$  times the phasor current. Figure 9.10 shows the frequency-domain equivalent circuit for the inductor. It is important to note that the relationship between phasor voltage and phasor current for an inductor applies as well for the mutual inductance in one coil due to current flowing in another mutually coupled coil. That is, the phasor voltage at the terminals of one coil in a mutually coupled pair of coils equals  $j\omega M$  times the phasor current in the other coil.

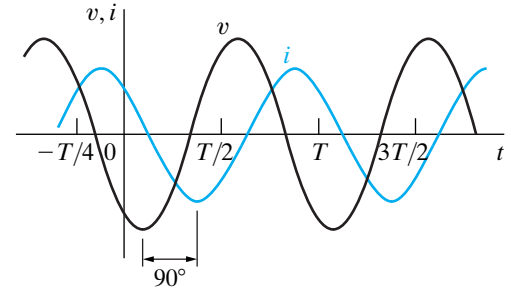


We can rewrite Eq. 9.30 as

$$\begin{aligned}\mathbf{V} &= (\omega L \angle 90^\circ) I_m \angle \theta_i \\ &= \omega L I_m \angle (\theta_i + 90)^\circ,\end{aligned}\quad (9.31)$$

which indicates that the voltage and current are out of phase by exactly  $90^\circ$ . In particular, the voltage leads the current by  $90^\circ$ , or, equivalently, the current lags behind the voltage by  $90^\circ$ . Figure 9.11 illustrates this concept of *voltage leading current* or *current lagging voltage*. For example, the voltage reaches its negative peak exactly  $90^\circ$  before the current reaches its negative peak. The same observation can be made with respect to the zero-going-positive crossing or the positive peak.

We can also express the phase shift in seconds. A phase shift of  $90^\circ$  corresponds to one-fourth of a period; hence the voltage leads the current by  $T/4$ , or  $\frac{1}{4f}$  second.



**Figure 9.11** ▲ A plot showing the phase relationship between the current and voltage at the terminals of an inductor ( $\theta_i = 60^\circ$ ).

### The V-I Relationship for a Capacitor

We obtain the relationship between the phasor current and phasor voltage at the terminals of a capacitor from the derivation of Eq. 9.30. In other words, if we note that for a capacitor that

$$i = C \frac{dv}{dt},$$

and assume that

$$v = V_m \cos(\omega t + \theta_v),$$

then

$$\mathbf{I} = j\omega C \mathbf{V}.\quad (9.32)$$

Now if we solve Eq. 9.32 for the voltage as a function of the current, we get

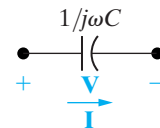
$$\mathbf{V} = \frac{1}{j\omega C} \mathbf{I}.\quad (9.33)$$

Equation 9.33 demonstrates that the equivalent circuit for the capacitor in the phasor domain is as shown in Fig. 9.12.

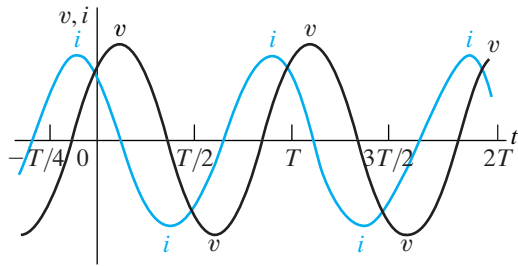
The voltage across the terminals of a capacitor lags behind the current by exactly  $90^\circ$ . We can easily show this relationship by rewriting Eq. 9.33 as

$$\begin{aligned}\mathbf{V} &= \frac{1}{\omega C} \angle -90^\circ I_m \angle \theta_i \\ &= \frac{I_m}{\omega C} \angle (\theta_i - 90)^\circ.\end{aligned}\quad (9.34)$$

◀ **Relationship between phasor voltage and phasor current for a capacitor**



**Figure 9.12** ▲ The frequency domain equivalent circuit of a capacitor.



**Figure 9.13** ▲ A plot showing the phase relationship between the current and voltage at the terminals of a capacitor ( $\theta_i = 60^\circ$ ).

The alternative way to express the phase relationship contained in Eq. 9.34 is to say that the current leads the voltage by  $90^\circ$ . Figure 9.13 shows the phase relationship between the current and voltage at the terminals of a capacitor.

### Impedance and Reactance

We conclude this discussion of passive circuit elements in the frequency domain with an important observation. When we compare Eqs. 9.27, 9.30, and 9.33, we note that they are all of the form

$$\mathbf{V} = Z\mathbf{I}, \tag{9.35}$$

**Definition of impedance** ►

where  $Z$  represents the **impedance** of the circuit element. Solving for  $Z$  in Eq. 9.35, you can see that impedance is the ratio of a circuit element’s voltage phasor to its current phasor. Thus the impedance of a resistor is  $R$ , the impedance of an inductor is  $j\omega L$ , the impedance of mutual inductance is  $j\omega M$ , and the impedance of a capacitor is  $1/j\omega C$ . In all cases, impedance is measured in ohms. Note that, although impedance is a complex number, it is not a phasor. Remember, a phasor is a complex number that shows up as the coefficient of  $e^{j\omega t}$ . Thus, although all phasors are complex numbers, not all complex numbers are phasors.

Impedance in the frequency domain is the quantity analogous to resistance, inductance, and capacitance in the time domain. The imaginary part of the impedance is called **reactance**. The values of impedance and reactance for each of the component values are summarized in Table 9.1.

And finally, a reminder. If the reference direction for the current in a passive circuit element is in the direction of the voltage rise across the element, you must insert a minus sign into the equation that relates the voltage to the current.

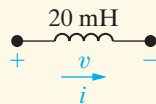
**TABLE 9.1** Impedance and Reactance Values

Circuit Element	Impedance	Reactance
Resistor	$R$	—
Inductor	$j\omega L$	$\omega L$
Capacitor	$j(-1/\omega C)$	$-1/\omega C$

## ASSESSMENT PROBLEMS

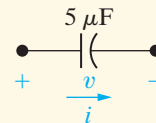
**Objective 2**—Be able to transform a circuit with a sinusoidal source into the frequency domain using phasor concepts

**9.3** The current in the 20 mH inductor is  $10 \cos(10,000t + 30^\circ)$  mA. Calculate (a) the inductive reactance; (b) the impedance of the inductor; (c) the phasor voltage  $\mathbf{V}$ ; and (d) the steady-state expression for  $v(t)$ .



**Answer:** (a)  $200 \Omega$ ;  
 (b)  $j200 \Omega$ ;  
 (c)  $2 \angle 120^\circ$  V;  
 (d)  $2 \cos(10,000t + 120^\circ)$  V.

**9.4** The voltage across the terminals of the  $5 \mu\text{F}$  capacitor is  $30 \cos(4000t + 25^\circ)$  V. Calculate (a) the capacitive reactance; (b) the impedance of the capacitor; (c) the phasor current  $\mathbf{I}$ ; and (d) the steady-state expression for  $i(t)$ .



**Answer:** (a)  $-50 \Omega$ ;  
 (b)  $-j50 \Omega$ ;  
 (c)  $0.6 \angle 115^\circ$  A;  
 (d)  $0.6 \cos(4000t + 115^\circ)$  A.

**NOTE:** Also try Chapter Problems 9.12 and 9.13.

## 9.5 Kirchhoff's Laws in the Frequency Domain

We pointed out in Section 9.3, with reference to Eqs. 9.23 and 9.24, that the phasor transform is useful in circuit analysis because it applies to the sum of sinusoidal functions. We illustrated this usefulness in Example 9.5. We now formalize this observation by developing Kirchhoff's laws in the frequency domain.

### Kirchhoff's Voltage Law in the Frequency Domain

We begin by assuming that  $v_1 - v_n$  represent voltages around a closed path in a circuit. We also assume that the circuit is operating in a sinusoidal steady state. Thus Kirchhoff's voltage law requires that

$$v_1 + v_2 + \cdots + v_n = 0, \quad (9.36)$$

which in the sinusoidal steady state becomes complex

$$V_{m_1} \cos(\omega t + \theta_1) + V_{m_2} \cos(\omega t + \theta_2) + \cdots + V_{m_n} \cos(\omega t + \theta_n) = 0. \quad (9.37)$$

We now use Euler's identity to write Eq. 9.37 as

$$\Re\{V_{m_1} e^{j\theta_1} e^{j\omega t}\} + \Re\{V_{m_2} e^{j\theta_2} e^{j\omega t}\} + \cdots + \Re\{V_{m_n} e^{j\theta_n} e^{j\omega t}\} \quad (9.38)$$

which we rewrite as

$$\Re\{V_{m_1} e^{j\theta_1} e^{j\omega t} + V_{m_2} e^{j\theta_2} e^{j\omega t} + \cdots + V_{m_n} e^{j\theta_n} e^{j\omega t}\} = 0. \quad (9.39)$$

Factoring the term  $e^{j\omega t}$  from each term yields

$$\Re\{(V_{m_1} e^{j\theta_1} + V_{m_2} e^{j\theta_2} + \cdots + V_{m_n} e^{j\theta_n}) e^{j\omega t}\} = 0,$$

or

$$\Re\{(\mathbf{V}_1 + \mathbf{V}_2 + \cdots + \mathbf{V}_n) e^{j\omega t}\} = 0. \quad (9.40)$$

But  $e^{j\omega t} \neq 0$ , so

$$\mathbf{V}_1 + \mathbf{V}_2 + \cdots + \mathbf{V}_n = 0, \quad (9.41) \quad \blacktriangleleft \text{KVL in the frequency domain}$$

which is the statement of Kirchhoff's voltage law as it applies to phasor voltages. In other words, Eq. 9.36 applies to a set of sinusoidal voltages in the time domain, and Eq. 9.41 is the equivalent statement in the frequency domain.

### Kirchhoff's Current Law in the Frequency Domain

A similar derivation applies to a set of sinusoidal currents. Thus if

$$i_1 + i_2 + \cdots + i_n = 0, \quad (9.42)$$

then

**KCL in the frequency domain** ▶

$$\mathbf{I}_1 + \mathbf{I}_2 + \cdots + \mathbf{I}_n = 0, \quad (9.43)$$

where  $\mathbf{I}_1, \mathbf{I}_2, \dots, \mathbf{I}_n$  are the phasor representations of the individual currents  $i_1, i_2, \dots, i_n$ .

Equations 9.35, 9.41, and 9.43 form the basis for circuit analysis in the frequency domain. Note that Eq. 9.35 has the same algebraic form as Ohm's law, and that Eqs. 9.41 and 9.43 state Kirchhoff's laws for phasor quantities. Therefore you may use all the techniques developed for analyzing resistive circuits to find phasor currents and voltages. You need learn no new analytic techniques; the basic circuit analysis and simplification tools covered in Chapters 2–4 can all be used to analyze circuits in the frequency domain. Phasor circuit analysis consists of two fundamental tasks: (1) You must be able to construct the frequency-domain model of a circuit; and (2) you must be able to manipulate complex numbers and/or quantities algebraically. We illustrate these aspects of phasor analysis in the discussion that follows, beginning with series, parallel, and delta-to-wye simplifications.

### ASSESSMENT PROBLEM

**Objective 3—Know how to use circuit analysis techniques to solve a circuit in the frequency domain**

**9.5** Four branches terminate at a common node. The reference direction of each branch current ( $i_1, i_2, i_3$ , and  $i_4$ ) is toward the node. If

$$\begin{aligned} i_1 &= 100 \cos(\omega t + 25^\circ) \text{ A}, \\ i_2 &= 100 \cos(\omega t + 145^\circ) \text{ A}, \text{ and} \\ i_3 &= 100 \cos(\omega t - 95^\circ) \text{ A}, \text{ find } i_4. \end{aligned}$$

*NOTE:* Also try Chapter Problem 9.15.

**Answer:**  $i_4 = 0$ .

## 9.6 Series, Parallel, and Delta-to-Wye Simplifications

The rules for combining impedances in series or parallel and for making delta-to-wye transformations are the same as those for resistors. The only difference is that combining impedances involves the algebraic manipulation of complex numbers.

### Combining Impedances in Series and Parallel

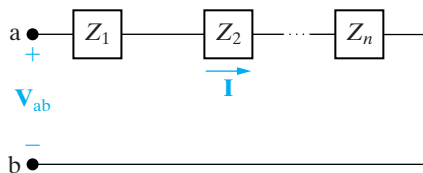
Impedances in series can be combined into a single impedance by simply adding the individual impedances. The circuit shown in Fig. 9.14 defines the problem in general terms. The impedances  $Z_1, Z_2, \dots, Z_n$  are connected in series between terminals a,b. When impedances are in series, they carry the same phasor current  $\mathbf{I}$ . From Eq. 9.35, the voltage drop across each impedance is  $Z_1\mathbf{I}, Z_2\mathbf{I}, \dots, Z_n\mathbf{I}$ , and from Kirchhoff's voltage law,

$$\begin{aligned} \mathbf{V}_{ab} &= Z_1\mathbf{I} + Z_2\mathbf{I} + \cdots + Z_n\mathbf{I} \\ &= (Z_1 + Z_2 + \cdots + Z_n)\mathbf{I}. \end{aligned} \quad (9.44)$$

The equivalent impedance between terminals a,b is

$$Z_{ab} = \frac{\mathbf{V}_{ab}}{\mathbf{I}} = Z_1 + Z_2 + \cdots + Z_n. \quad (9.45)$$

Example 9.6 illustrates a numerical application of Eq. 9.45.

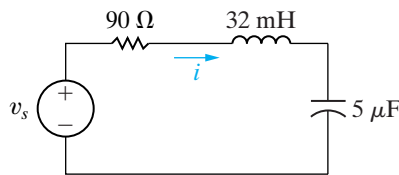


**Figure 9.14** ▲ Impedances in series.

**Example 9.6** Combining Impedances in Series

A  $90\ \Omega$  resistor, a  $32\ \text{mH}$  inductor, and a  $5\ \mu\text{F}$  capacitor are connected in series across the terminals of a sinusoidal voltage source, as shown in Fig. 9.15. The steady-state expression for the source voltage  $v_s$  is  $750 \cos(5000t + 30^\circ)\ \text{V}$ .

- Construct the frequency-domain equivalent circuit.
- Calculate the steady-state current  $i$  by the phasor method.



**Figure 9.15** ▲ The circuit for Example 9.6.

**Solution**

- From the expression for  $v_s$ , we have  $\omega = 5000\ \text{rad/s}$ . Therefore the impedance of the  $32\ \text{mH}$  inductor is

$$Z_L = j\omega L = j(5000)(32 \times 10^{-3}) = j160\ \Omega,$$

and the impedance of the capacitor is

$$Z_C = j \frac{-1}{\omega C} = -j \frac{10^6}{(5000)(5)} = -j40\ \Omega.$$

The phasor transform of  $v_s$  is

$$\mathbf{V}_s = 750 \angle 30^\circ\ \text{V}.$$

Figure 9.16 illustrates the frequency-domain equivalent circuit of the circuit shown in Fig. 9.15.

- We compute the phasor current simply by dividing the voltage of the voltage source by the equivalent impedance between the terminals a,b. From Eq. 9.45,

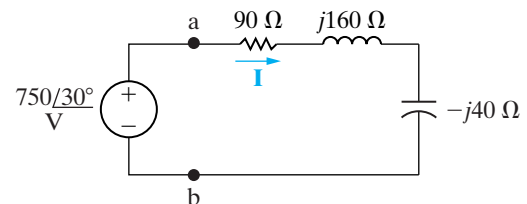
$$\begin{aligned} Z_{ab} &= 90 + j160 - j40 \\ &= 90 + j120 = 150 \angle 53.13^\circ\ \Omega. \end{aligned}$$

Thus

$$\mathbf{I} = \frac{750 \angle 30^\circ}{150 \angle 53.13^\circ} = 5 \angle -23.13^\circ\ \text{A}.$$

We may now write the steady-state expression for  $i$  directly:

$$i = 5 \cos(5000t - 23.13^\circ)\ \text{A}.$$



**Figure 9.16** ▲ The frequency-domain equivalent circuit of the circuit shown in Fig. 9.15.

**ASSESSMENT PROBLEM**

**Objective 3**—Know how to use circuit analysis techniques to solve a circuit in the frequency domain

**9.6** Using the values of resistance and inductance in the circuit of Fig. 9.15, let  $\mathbf{V}_s = 125 \angle -60^\circ\ \text{V}$  and  $\omega = 5000\ \text{rad/s}$ . Find

- the value of capacitance that yields a steady-state output current  $i$  with a phase angle of  $-105^\circ$ .

- the magnitude of the steady-state output current  $i$ .

**Answer:** (a)  $2.86\ \mu\text{F}$ ;  
(b)  $0.982\ \text{A}$ .

*NOTE:* Also try Chapter Problem 9.17.

Impedances connected in parallel may be reduced to a single equivalent impedance by the reciprocal relationship

$$\frac{1}{Z_{ab}} = \frac{1}{Z_1} + \frac{1}{Z_2} + \cdots + \frac{1}{Z_n}. \quad (9.46)$$

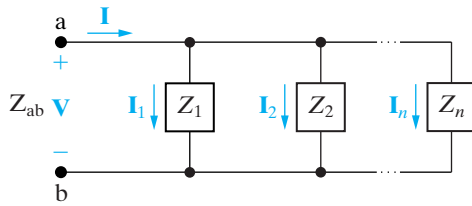


Figure 9.17 ▲ Impedances in parallel.

Figure 9.17 depicts the parallel connection of impedances. Note that when impedances are in parallel, they have the same voltage across their terminals. We derive Eq. 9.46 directly from Fig. 9.17 by simply combining Kirchhoff's current law with the phasor-domain version of Ohm's law, that is, Eq. 9.35. From Fig. 9.17,

$$I = I_1 + I_2 + \cdots + I_n,$$

or

$$\frac{V}{Z_{ab}} = \frac{V}{Z_1} + \frac{V}{Z_2} + \cdots + \frac{V}{Z_n}. \quad (9.47)$$

Canceling the common voltage term out of Eq. 9.47 reveals Eq. 9.46.

From Eq. 9.46, for the special case of just two impedances in parallel,

$$Z_{ab} = \frac{Z_1 Z_2}{Z_1 + Z_2}. \quad (9.48)$$

We can also express Eq. 9.46 in terms of **admittance**, defined as the reciprocal of impedance and denoted  $Y$ . Thus

$$Y = \frac{1}{Z} = G + jB \text{ (siemens)}. \quad (9.49)$$

Admittance is, of course, a complex number, whose real part,  $G$ , is called **conductance** and whose imaginary part,  $B$ , is called **susceptance**. Like admittance, conductance and susceptance are measured in siemens (S). Using Eq. 9.49 in Eq. 9.46, we get

$$Y_{ab} = Y_1 + Y_2 + \cdots + Y_n. \quad (9.50)$$

The admittance of each of the ideal passive circuit elements also is worth noting and is summarized in Table 9.2.

Example 9.7 illustrates the application of Eqs. 9.49 and 9.50 to a specific circuit.

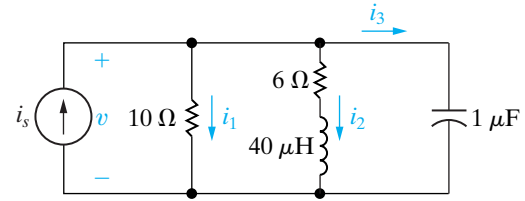
TABLE 9.2 Admittance and Susceptance Values

Circuit Element	Admittance ( $Y$ )	Susceptance
Resistor	$G$ (conductance)	—
Inductor	$j(-1/\omega L)$	$-1/\omega L$
Capacitor	$j\omega C$	$\omega C$

**Example 9.7** Combining Impedances in Series and in Parallel

The sinusoidal current source in the circuit shown in Fig. 9.18 produces the current  $i_s = 8 \cos 200,000t$  A.

- Construct the frequency-domain equivalent circuit.
- Find the steady-state expressions for  $v$ ,  $i_1$ ,  $i_2$ , and  $i_3$ .



**Figure 9.18** ▲ The circuit for Example 9.7.

**Solution**

- The phasor transform of the current source is  $8 \angle 0^\circ$ ; the resistors transform directly to the frequency domain as 10 and 6  $\Omega$ ; the 40  $\mu\text{H}$  inductor has an impedance of  $j8 \Omega$  at the given frequency of 200,000 rad/s; and at this frequency the 1  $\mu\text{F}$  capacitor has an impedance of  $-j5 \Omega$ . Figure 9.19 shows the frequency-domain equivalent circuit and symbols representing the phasor transforms of the unknowns.
- The circuit shown in Fig. 9.19 indicates that we can easily obtain the voltage across the current source once we know the equivalent impedance of the three parallel branches. Moreover, once we know  $\mathbf{V}$ , we can calculate the three phasor currents  $\mathbf{I}_1$ ,  $\mathbf{I}_2$ , and  $\mathbf{I}_3$  by using Eq. 9.35. To find the equivalent impedance of the three branches, we first find the equivalent admittance simply by adding the admittances of each branch. The admittance of the first branch is

$$Y_1 = \frac{1}{10} = 0.1 \text{ S},$$

the admittance of the second branch is

$$Y_2 = \frac{1}{6 + j8} = \frac{6 - j8}{100} = 0.06 - j0.08 \text{ S},$$

and the admittance of the third branch is

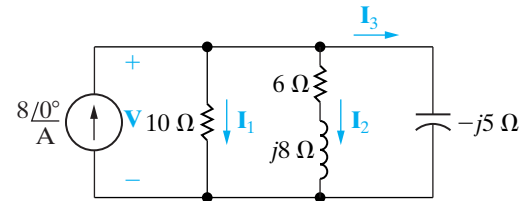
$$Y_3 = \frac{1}{-j5} = j0.2 \text{ S}.$$

The admittance of the three branches is

$$\begin{aligned} Y &= Y_1 + Y_2 + Y_3 \\ &= 0.16 + j0.12 \\ &= 0.2 \angle 36.87^\circ \text{ S}. \end{aligned}$$

The impedance at the current source is

$$Z = \frac{1}{Y} = 5 \angle -36.87^\circ \Omega.$$



**Figure 9.19** ▲ The frequency-domain equivalent circuit.

The Voltage  $\mathbf{V}$  is

$$\mathbf{V} = \mathbf{Z}\mathbf{I} = 40 \angle -36.87^\circ \text{ V}.$$

Hence

$$\mathbf{I}_1 = \frac{40 \angle -36.87^\circ}{10} = 4 \angle -36.87^\circ = 3.2 - j2.4 \text{ A},$$

$$\mathbf{I}_2 = \frac{40 \angle -36.87^\circ}{6 + j8} = 4 \angle -90^\circ = -j4 \text{ A},$$

and

$$\mathbf{I}_3 = \frac{40 \angle -36.87^\circ}{5 \angle -90^\circ} = 8 \angle 53.13^\circ = 4.8 + j6.4 \text{ A}.$$

We check the computations at this point by verifying that

$$\mathbf{I}_1 + \mathbf{I}_2 + \mathbf{I}_3 = \mathbf{I}.$$

Specifically,

$$3.2 - j2.4 - j4 + 4.8 + j6.4 = 8 + j0.$$

The corresponding steady-state time-domain expressions are

$$v = 40 \cos(200,000t - 36.87^\circ) \text{ V},$$

$$i_1 = 4 \cos(200,000t - 36.87^\circ) \text{ A},$$

$$i_2 = 4 \cos(200,000t - 90^\circ) \text{ A},$$

$$i_3 = 8 \cos(200,000t + 53.13^\circ) \text{ A}.$$



## ASSESSMENT PROBLEMS

### Objective 3—Know how to use circuit analysis techniques to solve a circuit in the frequency domain

**9.7** A  $20\ \Omega$  resistor is connected in parallel with a  $5\ \text{mH}$  inductor. This parallel combination is connected in series with a  $5\ \Omega$  resistor and a  $25\ \mu\text{F}$  capacitor.

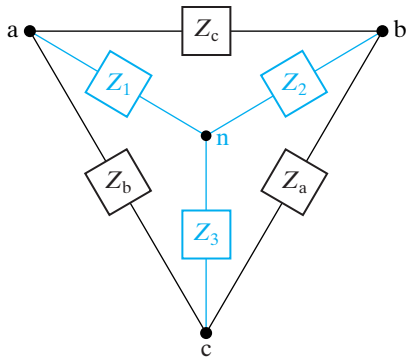
- Calculate the impedance of this interconnection if the frequency is  $2\ \text{krad/s}$ .
- Repeat (a) for a frequency of  $8\ \text{krad/s}$ .
- At what finite frequency does the impedance of the interconnection become purely resistive?
- What is the impedance at the frequency found in (c)?

**Answer:** (a)  $9 - j12\ \Omega$ ;  
 (b)  $21 + j3\ \Omega$ ;  
 (c)  $4\ \text{krad/s}$ ;  
 (d)  $15\ \Omega$ .

**9.8** The interconnection described in Assessment Problem 9.7 is connected across the terminals of a voltage source that is generating  $v = 150 \cos 4000t\ \text{V}$ . What is the maximum amplitude of the current in the  $5\ \text{mH}$  inductor?

**Answer:**  $7.07\ \text{A}$ .

*NOTE: Also try Chapter Problems 9.29, 9.34, and 9.35.*



**Figure 9.20** ▲ The delta-to-wye transformation.

### Delta-to-Wye Transformations

The  $\Delta$ -to- $Y$  transformation that we discussed in Section 3.7 with regard to resistive circuits also applies to impedances. Figure 9.20 defines the  $\Delta$ -connected impedances along with the  $Y$ -equivalent circuit. The  $Y$  impedances as functions of the  $\Delta$  impedances are

$$Z_1 = \frac{Z_b Z_c}{Z_a + Z_b + Z_c}, \quad (9.51)$$

$$Z_2 = \frac{Z_c Z_a}{Z_a + Z_b + Z_c}, \quad (9.52)$$

$$Z_3 = \frac{Z_a Z_b}{Z_a + Z_b + Z_c}. \quad (9.53)$$

The  $\Delta$ -to- $Y$  transformation also may be reversed; that is, we can start with the  $Y$  structure and replace it with an equivalent  $\Delta$  structure. The  $\Delta$  impedances as functions of the  $Y$  impedances are

$$Z_a = \frac{Z_1 Z_2 + Z_2 Z_3 + Z_3 Z_1}{Z_1}, \quad (9.54)$$

$$Z_b = \frac{Z_1 Z_2 + Z_2 Z_3 + Z_3 Z_1}{Z_2}, \quad (9.55)$$

$$Z_c = \frac{Z_1 Z_2 + Z_2 Z_3 + Z_3 Z_1}{Z_3}. \quad (9.56)$$

The process used to derive Eqs. 9.51–9.53 or Eqs. 9.54–9.56 is the same as that used to derive the corresponding equations for pure resistive circuits. In fact, comparing Eqs. 3.44–3.46 with Eqs. 9.51–9.53, and Eqs. 3.47–3.49 with Eqs. 9.54–9.56, reveals that the symbol  $Z$  has replaced

the symbol  $R$ . You may want to review Problem 3.62 concerning the derivation of the  $\Delta$ -to- $Y$  transformation.

Example 9.8 illustrates the usefulness of the  $\Delta$ -to- $Y$  transformation in phasor circuit analysis.

### Example 9.8 Using a Delta-to-Wye Transform in the Frequency Domain

Use a  $\Delta$ -to- $Y$  impedance transformation to find  $\mathbf{I}_0$ ,  $\mathbf{I}_1$ ,  $\mathbf{I}_2$ ,  $\mathbf{I}_3$ ,  $\mathbf{I}_4$ ,  $\mathbf{I}_5$ ,  $\mathbf{V}_1$ , and  $\mathbf{V}_2$  in the circuit in Fig. 9.21.

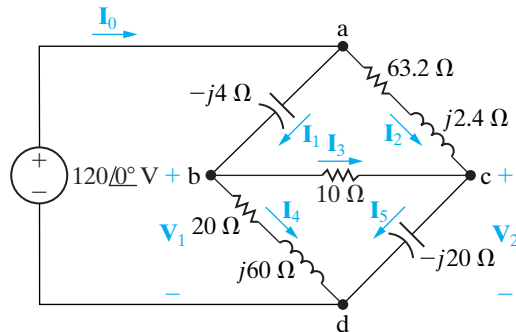


Figure 9.21 ▲ The circuit for Example 9.8.

### Solution

First note that the circuit is not amenable to series or parallel simplification as it now stands. A  $\Delta$ -to- $Y$  impedance transformation allows us to solve for all the branch currents without resorting to either the node-voltage or the mesh-current method. If we replace either the upper delta ( $abc$ ) or the lower delta ( $bcd$ ) with its  $Y$  equivalent, we can further simplify the resulting circuit by series-parallel combinations. In deciding which delta to replace, the sum of the impedances around each delta is worth checking because this quantity forms the denominator for the equivalent  $Y$  impedances. The sum around the lower delta is  $30 + j40$ , so we choose to eliminate it from the circuit. The  $Y$  impedance connecting to terminal  $b$  is

$$Z_1 = \frac{(20 + j60)(10)}{30 + j40} = 12 + j4\Omega,$$

the  $Y$  impedance connecting to terminal  $c$  is

$$Z_2 = \frac{10(-j20)}{30 + j40} = -3.2 - j2.4\Omega,$$

and the  $Y$  impedance connecting to terminal  $d$  is

$$Z_3 = \frac{(20 + j60)(-j20)}{30 + j40} = 8 - j24\Omega.$$

Inserting the  $Y$ -equivalent impedances into the circuit, we get the circuit shown in Fig. 9.22, which we can now simplify by series-parallel reductions. The impedance of the  $abn$  branch is

$$Z_{abn} = 12 + j4 - j4 = 12\Omega,$$

and the impedance of the  $acn$  branch is

$$Z_{acn} = 63.2 + j2.4 - j2.4 - 3.2 = 60\Omega.$$

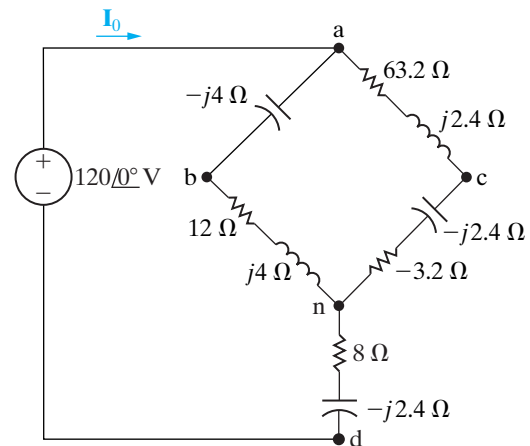


Figure 9.22 ▲ The circuit shown in Fig. 9.21, with the lower delta replaced by its equivalent wye.

Note that the  $abn$  branch is in parallel with the  $acn$  branch. Therefore we may replace these two branches with a single branch having an impedance of

$$Z_{an} = \frac{(60)(12)}{72} = 10\Omega.$$

Combining this  $10\Omega$  resistor with the impedance between  $n$  and  $d$  reduces the circuit shown in Fig. 9.22 to the one shown in Fig. 9.23. From the latter circuit,

$$\mathbf{I}_0 = \frac{120\angle 0^\circ}{18 - j24} = 4\angle 53.13^\circ = 2.4 + j3.2\text{ A}.$$

Once we know  $\mathbf{I}_0$ , we can work back through the equivalent circuits to find the branch currents in the original circuit. We begin by noting that  $\mathbf{I}_0$  is the current in the branch  $nd$  of Fig. 9.22. Therefore

$$\mathbf{V}_{nd} = (8 - j24)\mathbf{I}_0 = 96 - j32\text{ V}.$$

We may now calculate the voltage  $\mathbf{V}_{an}$  because

$$\mathbf{V} = \mathbf{V}_{an} + \mathbf{V}_{nd}$$

and both  $\mathbf{V}$  and  $\mathbf{V}_{nd}$  are known. Thus

$$\mathbf{V}_{an} = 120 - 96 + j32 = 24 + j32 \text{ V.}$$

We now compute the branch currents  $\mathbf{I}_{abn}$  and  $\mathbf{I}_{acn}$ :

$$\mathbf{I}_{abn} = \frac{24 + j32}{12} = 2 + j\frac{8}{3} \text{ A,}$$

$$\mathbf{I}_{acn} = \frac{24 + j32}{60} = \frac{4}{10} + j\frac{8}{15} \text{ A.}$$

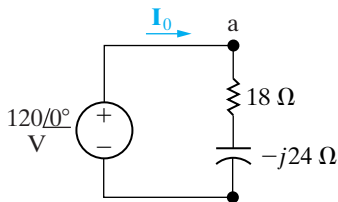
In terms of the branch currents defined in Fig. 9.21,

$$\mathbf{I}_1 = \mathbf{I}_{abn} = 2 + j\frac{8}{3} \text{ A,}$$

$$\mathbf{I}_2 = \mathbf{I}_{acn} = \frac{4}{10} + j\frac{8}{15} \text{ A.}$$

We check the calculations of  $\mathbf{I}_1$  and  $\mathbf{I}_2$  by noting that

$$\mathbf{I}_1 + \mathbf{I}_2 = 2.4 + j3.2 = \mathbf{I}_0.$$



**Figure 9.23** ▲ A simplified version of the circuit shown in Fig. 9.22.

To find the branch currents  $\mathbf{I}_3$ ,  $\mathbf{I}_4$ , and  $\mathbf{I}_5$ , we must first calculate the voltages  $\mathbf{V}_1$  and  $\mathbf{V}_2$ . Referring to Fig. 9.21, we note that

$$\mathbf{V}_1 = 120 \angle 0^\circ - (-j4)\mathbf{I}_1 = \frac{328}{3} + j8 \text{ V,}$$

$$\mathbf{V}_2 = 120 \angle 0^\circ - (63.2 + j2.4)\mathbf{I}_2 = 96 - j\frac{104}{3} \text{ V.}$$

We now calculate the branch currents  $\mathbf{I}_3$ ,  $\mathbf{I}_4$ , and  $\mathbf{I}_5$ :

$$\mathbf{I}_3 = \frac{\mathbf{V}_1 - \mathbf{V}_2}{10} = \frac{4}{3} + j\frac{12.8}{3} \text{ A,}$$

$$\mathbf{I}_4 = \frac{\mathbf{V}_1}{20 + j60} = \frac{2}{3} - j1.6 \text{ A,}$$

$$\mathbf{I}_5 = \frac{\mathbf{V}_2}{-j20} = \frac{26}{15} + j4.8 \text{ A.}$$

We check the calculations by noting that

$$\mathbf{I}_4 + \mathbf{I}_5 = \frac{2}{3} + \frac{26}{15} - j1.6 + j4.8 = 2.4 + j3.2 = \mathbf{I}_0,$$

$$\mathbf{I}_3 + \mathbf{I}_4 = \frac{4}{3} + \frac{2}{3} + j\frac{12.8}{3} - j1.6 = 2 + j\frac{8}{3} = \mathbf{I}_1,$$

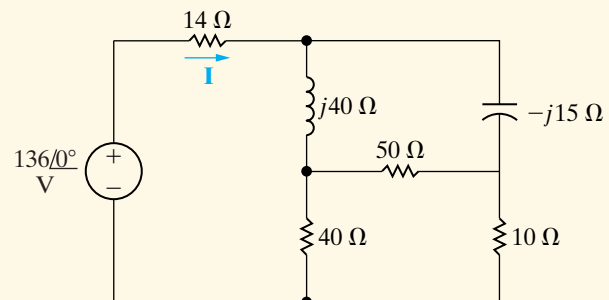
$$\mathbf{I}_3 + \mathbf{I}_2 = \frac{4}{3} + \frac{4}{10} + j\frac{12.8}{3} + j\frac{8}{15} = \frac{26}{15} + j4.8 = \mathbf{I}_5.$$

## ASSESSMENT PROBLEM

**Objective 3**—Know how to use circuit analysis techniques to solve a circuit in the frequency domain

**9.9** Use a  $\Delta$ -to-Y transformation to find the current  $\mathbf{I}$  in the circuit shown.

**Answer:**  $\mathbf{I} = 4 \angle 28.07^\circ \text{ A.}$



**NOTE:** Also try Chapter Problem 9.42.

## 9.7 Source Transformations and Thévenin-Norton Equivalent Circuits

The source transformations introduced in Section 4.9 and the Thévenin-Norton equivalent circuits discussed in Section 4.10 are analytical techniques that also can be applied to frequency-domain circuits. We prove the validity of these techniques by following the same process used in Sections 4.9 and 4.10, except that we substitute impedance ( $Z$ ) for resistance ( $R$ ). Figure 9.24 shows a source-transformation equivalent circuit with the nomenclature of the frequency domain.

Figure 9.25 illustrates the frequency-domain version of a Thévenin equivalent circuit. Figure 9.26 shows the frequency-domain equivalent of a Norton equivalent circuit. The techniques for finding the Thévenin equivalent voltage and impedance are identical to those used for resistive circuits, except that the frequency-domain equivalent circuit involves the manipulation of complex quantities. The same holds for finding the Norton equivalent current and impedance.

Example 9.9 demonstrates the application of the source-transformation equivalent circuit to frequency-domain analysis. Example 9.10 illustrates the details of finding a Thévenin equivalent circuit in the frequency domain.

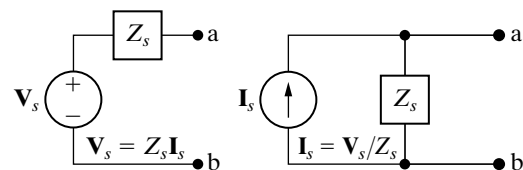


Figure 9.24 ▲ A source transformation in the frequency domain.

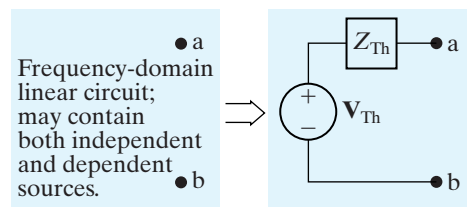


Figure 9.25 ▲ The frequency-domain version of a Thévenin equivalent circuit.

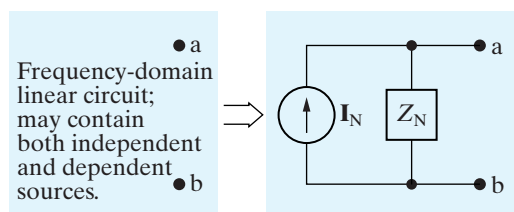


Figure 9.26 ▲ The frequency-domain version of a Norton equivalent circuit.

### Example 9.9 Performing Source Transformations in the Frequency Domain

Use the concept of source transformation to find the phasor voltage  $V_0$  in the circuit shown in Fig. 9.27.

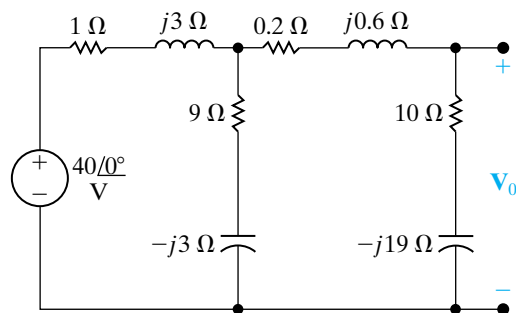


Figure 9.27 ▲ The circuit for Example 9.9.

#### Solution

We can replace the series combination of the voltage source ( $40\angle 0^\circ$ ) and the impedance of  $1 + j3\ \Omega$  with the parallel combination of a

current source and the  $1 + j3\ \Omega$  impedance. The source current is

$$\mathbf{I} = \frac{40}{1 + j3} = \frac{40}{10}(1 - j3) = 4 - j12\ \text{A}.$$

Thus we can modify the circuit shown in Fig. 9.27 to the one shown in Fig. 9.28. Note that the polarity reference of the 40 V source determines the reference direction for  $\mathbf{I}$ .

Next, we combine the two parallel branches into a single impedance,

$$Z = \frac{(1 + j3)(9 - j3)}{10} = 1.8 + j2.4\ \Omega,$$

which is in parallel with the current source of  $4 - j12$  A. Another source transformation converts this parallel combination to a series combination consisting of a voltage source in series with the impedance of  $1.8 + j2.4 \Omega$ . The voltage of the voltage source is

$$\mathbf{V} = (4 - j12)(1.8 + j2.4) = 36 - j12 \text{ V.}$$

Using this source transformation, we redraw the circuit as Fig. 9.29. Note the polarity of the voltage source. We added the current  $\mathbf{I}_0$  to the circuit to expedite the solution for  $\mathbf{V}_0$ .

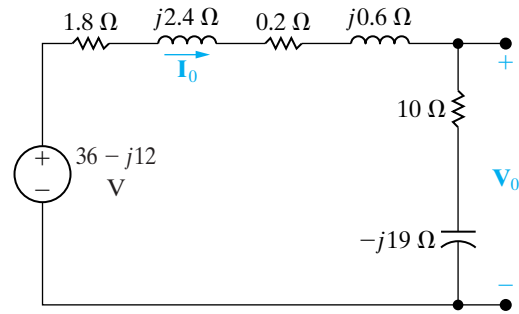


Figure 9.29 ▲ The second step in reducing the circuit shown in Fig. 9.27.

Also note that we have reduced the circuit to a simple series circuit. We calculate the current  $\mathbf{I}_0$  by dividing the voltage of the source by the total series impedance:

$$\begin{aligned} \mathbf{I}_0 &= \frac{36 - j12}{12 - j16} = \frac{12(3 - j1)}{4(3 - j4)} \\ &= \frac{39 + j27}{25} = 1.56 + j1.08 \text{ A.} \end{aligned}$$

We now obtain the value of  $\mathbf{V}_0$  by multiplying  $\mathbf{I}_0$  by the impedance  $10 - j19$ :

$$\mathbf{V}_0 = (1.56 + j1.08)(10 - j19) = 36.12 - j18.84 \text{ V.}$$

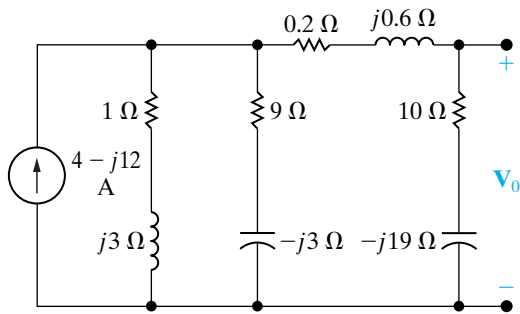


Figure 9.28 ▲ The first step in reducing the circuit shown in Fig. 9.27.

**Example 9.10** Finding a Thévenin Equivalent in the Frequency Domain

Find the Thévenin equivalent circuit with respect to terminals a,b for the circuit shown in Fig. 9.30.

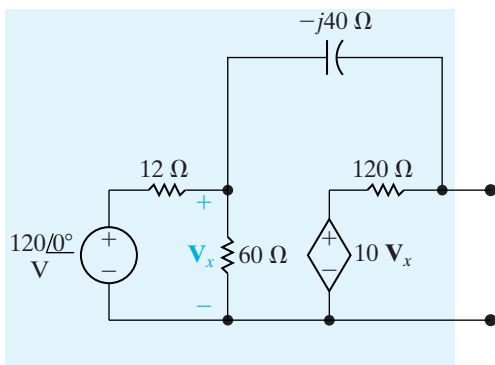


Figure 9.30 ▲ The circuit for Example 9.10.

**Solution**

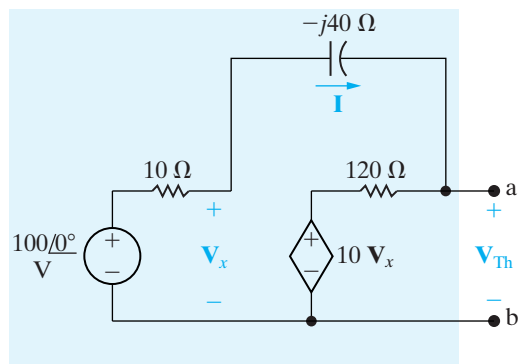
We first determine the Thévenin equivalent voltage. This voltage is the open-circuit voltage appearing at terminals a,b. We choose the reference for the Thévenin voltage as positive at terminal a. We can make two source transformations relative to the 120 V, 12  $\Omega$ , and 60  $\Omega$  circuit elements to simplify this portion of the circuit. At the same time, these transformations must preserve the identity of the controlling voltage  $\mathbf{V}_x$  because of the dependent voltage source.

We determine the two source transformations by first replacing the series combination of the 120 V source and 12  $\Omega$  resistor with a 10 A current source in parallel with 12  $\Omega$ . Next, we replace the parallel combination of the 12 and 60  $\Omega$  resistors with a single 10  $\Omega$  resistor. Finally, we replace the 10 A source in parallel with 10  $\Omega$  with a 100 V source in series with 10  $\Omega$ . Figure 9.31 shows the resulting circuit.

We added the current  $\mathbf{I}$  to Fig. 9.31 to aid further discussion. Note that once we know the current

$\mathbf{I}$ , we can compute the Thévenin voltage. We find  $\mathbf{I}$  by summing the voltages around the closed path in the circuit shown in Fig. 9.31. Hence

$$100 = 10\mathbf{I} - j40\mathbf{I} + 120\mathbf{I} + 10\mathbf{V}_x = (130 - j40)\mathbf{I} + 10\mathbf{V}_x.$$



**Figure 9.31** ▲ A simplified version of the circuit shown in Fig. 9.30.

We relate the controlling voltage  $\mathbf{V}_x$  to the current  $\mathbf{I}$  by noting from Fig. 9.31 that

$$\mathbf{V}_x = 100 - 10\mathbf{I}.$$

Then,

$$\mathbf{I} = \frac{-900}{30 - j40} = 18 \angle -126.87^\circ \text{ A.}$$

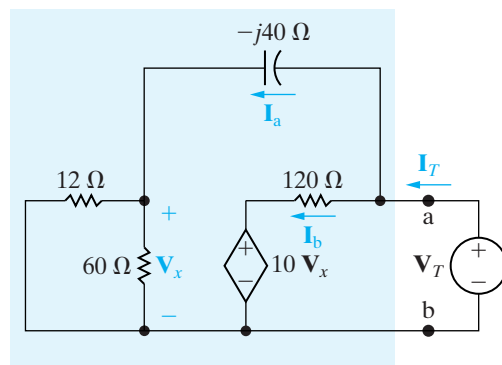
we now calculate  $\mathbf{V}_x$ :

$$\mathbf{V}_x = 100 - 180 \angle -126.87^\circ = 208 + j144 \text{ V.}$$

Finally, we note from Fig. 9.31 that

$$\begin{aligned} \mathbf{V}_{\text{Th}} &= 10\mathbf{V}_x + 120\mathbf{I} \\ &= 2080 + j1440 + 120(18) \angle -126.87^\circ \\ &= 784 - j288 = 835.22 \angle -20.17^\circ \text{ V.} \end{aligned}$$

To obtain the Thévenin impedance, we may use any of the techniques previously used to find the Thévenin resistance. We illustrate the test-source method in this example. Recall that in using this method, we deactivate all independent sources from the circuit and then apply either a test voltage source or a test current source to the terminals of interest. The ratio of the voltage to the current at the source is the Thévenin impedance. Figure 9.32 shows the result of applying this technique to the circuit shown in Fig. 9.30. Note that we chose a test voltage source  $\mathbf{V}_T$ . Also note that we deactivated the independent voltage source with an appropriate short-circuit and preserved the identity of  $\mathbf{V}_x$ .



**Figure 9.32** ▲ A circuit for calculating the Thévenin equivalent impedance.

The branch currents  $\mathbf{I}_a$  and  $\mathbf{I}_b$  have been added to the circuit to simplify the calculation of  $\mathbf{I}_T$ . By straightforward applications of Kirchhoff's circuit laws, you should be able to verify the following relationships:

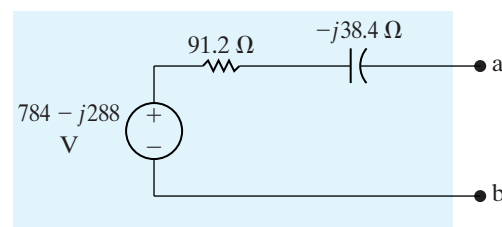
$$\mathbf{I}_a = \frac{\mathbf{V}_T}{10 - j40}, \quad \mathbf{V}_x = 10\mathbf{I}_a,$$

$$\begin{aligned} \mathbf{I}_b &= \frac{\mathbf{V}_T - 10\mathbf{V}_x}{120} \\ &= \frac{-\mathbf{V}_T(9 + j4)}{120(1 - j4)}, \end{aligned}$$

$$\begin{aligned} \mathbf{I}_T &= \mathbf{I}_a + \mathbf{I}_b \\ &= \frac{\mathbf{V}_T}{10 - j40} \left( 1 - \frac{9 + j4}{12} \right) \\ &= \frac{\mathbf{V}_T(3 - j4)}{12(10 - j40)}, \end{aligned}$$

$$\mathbf{Z}_{\text{Th}} = \frac{\mathbf{V}_T}{\mathbf{I}_T} = 91.2 - j38.4 \Omega.$$

Figure 9.33 depicts the Thévenin equivalent circuit.



**Figure 9.33** ▲ The Thévenin equivalent for the circuit shown in Fig. 9.30.

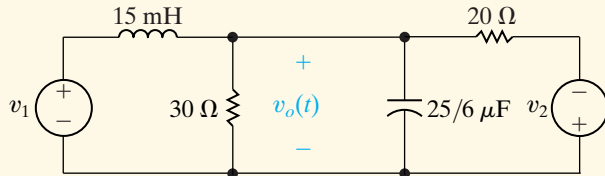
## ASSESSMENT PROBLEMS

**Objective 3**—Know how to use circuit analysis techniques to solve a circuit in the frequency domain

**9.10** Find the steady-state expression for  $v_o(t)$  in the circuit shown by using the technique of source transformations. The sinusoidal voltage sources are

$$v_1 = 240 \cos(4000t + 53.13^\circ) \text{ V},$$

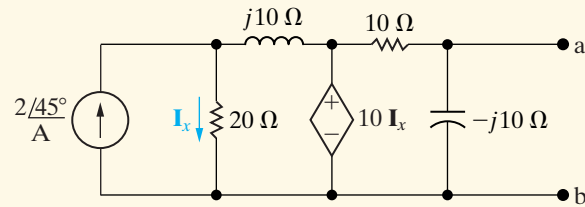
$$v_2 = 96 \sin 4000t \text{ V}.$$



**Answer:**  $48 \cos(4000t + 36.87^\circ) \text{ V}$

*NOTE:* Also try Chapter Problems 9.44, 9.45, and 9.48.

**9.11** Find the Thévenin equivalent with respect to terminals a,b in the circuit shown.



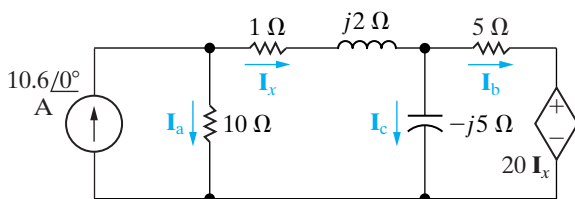
**Answer:**  $\mathbf{V}_{Th} = \mathbf{V}_{ab} = 10 \angle 45^\circ \text{ V};$   
 $\mathbf{Z}_{Th} = 5 - j5 \Omega.$

## 9.8 The Node-Voltage Method

In Sections 4.2–4.4, we introduced the basic concepts of the node-voltage method of circuit analysis. The same concepts apply when we use the node-voltage method to analyze frequency-domain circuits. Example 9.11 illustrates the solution of such a circuit by the node-voltage technique. Assessment Problem 9.12 and many of the Chapter Problems give you an opportunity to use the node-voltage method to solve for steady-state sinusoidal responses.

### Example 9.11 Using the Node-Voltage Method in the Frequency Domain

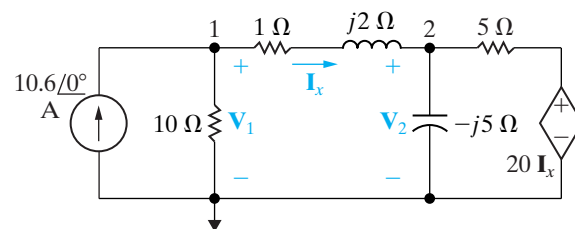
Use the node-voltage method to find the branch currents  $\mathbf{I}_a$ ,  $\mathbf{I}_b$ , and  $\mathbf{I}_c$  in the circuit shown in Fig. 9.34.



**Figure 9.34** ▲ The circuit for Example 9.11.

### Solution

We can describe the circuit in terms of two node voltages because it contains three essential nodes. Four branches terminate at the essential node that stretches across the bottom of Fig. 9.34, so we use it as the reference node. The remaining two essential nodes are labeled 1 and 2, and the appropriate node voltages are designated  $\mathbf{V}_1$  and  $\mathbf{V}_2$ . Figure 9.35 reflects the choice of reference node and the terminal labels.



**Figure 9.35** ▲ The circuit shown in Fig. 9.34, with the node voltages defined.

Summing the currents away from node 1 yields

$$-10.6 + \frac{\mathbf{V}_1}{10} + \frac{\mathbf{V}_1 - \mathbf{V}_2}{1 + j2} = 0.$$

Multiplying by  $1 + j2$  and collecting the coefficients of  $\mathbf{V}_1$  and  $\mathbf{V}_2$  generates the expression

$$\mathbf{V}_1(1.1 + j0.2) - \mathbf{V}_2 = 10.6 + j21.2.$$



Summing the currents away from node 2 gives

$$\frac{\mathbf{V}_2 - \mathbf{V}_1}{1 + j2} + \frac{\mathbf{V}_2}{-j5} + \frac{\mathbf{V}_2 - 20\mathbf{I}_x}{5} = 0.$$

The controlling current  $\mathbf{I}_x$  is

$$\mathbf{I}_x = \frac{\mathbf{V}_1 - \mathbf{V}_2}{1 + j2}.$$

Substituting this expression for  $\mathbf{I}_x$  into the node 2 equation, multiplying by  $1 + j2$ , and collecting coefficients of  $\mathbf{V}_1$  and  $\mathbf{V}_2$  produces the equation

$$-5\mathbf{V}_1 + (4.8 + j0.6)\mathbf{V}_2 = 0.$$

The solutions for  $\mathbf{V}_1$  and  $\mathbf{V}_2$  are

$$\begin{aligned}\mathbf{V}_1 &= 68.40 - j16.80 \text{ V}, \\ \mathbf{V}_2 &= 68 - j26 \text{ V}.\end{aligned}$$

Hence the branch currents are

$$\begin{aligned}\mathbf{I}_a &= \frac{\mathbf{V}_1}{10} = 6.84 - j1.68 \text{ A}, \\ \mathbf{I}_x &= \frac{\mathbf{V}_1 - \mathbf{V}_2}{1 + j2} = 3.76 + j1.68 \text{ A}, \\ \mathbf{I}_b &= \frac{\mathbf{V}_2 - 20\mathbf{I}_x}{5} = -1.44 - j11.92 \text{ A}, \\ \mathbf{I}_c &= \frac{\mathbf{V}_2}{-j5} = 5.2 + j13.6 \text{ A}.\end{aligned}$$

To check our work, we note that

$$\begin{aligned}\mathbf{I}_a + \mathbf{I}_x &= 6.84 - j1.68 + 3.76 + j1.68 \\ &= 10.6 \text{ A}, \\ \mathbf{I}_x &= \mathbf{I}_b + \mathbf{I}_c = -1.44 - j11.92 + 5.2 + j13.6 \\ &= 3.76 + j1.68 \text{ A}.\end{aligned}$$

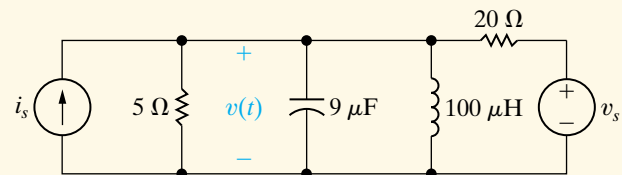
## ASSESSMENT PROBLEM

**Objective 3**—Know how to use circuit analysis techniques to solve a circuit in the frequency domain

**9.12** Use the node-voltage method to find the steady-state expression for  $v(t)$  in the circuit shown. The sinusoidal sources are  $i_s = 10 \cos \omega t$  A and  $v_s = 100 \sin \omega t$  V, where  $\omega = 50$  krad/s.

**Answer:**  $v(t) = 31.62 \cos(50,000t - 71.57^\circ)$  V.

*NOTE:* Also try Chapter Problems 9.54 and 9.58.



## 9.9 The Mesh-Current Method

We can also use the mesh-current method to analyze frequency-domain circuits. The procedures used in frequency-domain applications are the same as those used in analyzing resistive circuits. In Sections 4.5–4.7, we introduced the basic techniques of the mesh-current method; we demonstrate the extension of this method to frequency-domain circuits in Example 9.12.

### Example 9.12 Using the Mesh-Current Method in the Frequency Domain

Use the mesh-current method to find the voltages  $\mathbf{V}_1$ ,  $\mathbf{V}_2$ , and  $\mathbf{V}_3$  in the circuit shown in Fig. 9.36 on the next page.

#### Solution

The circuit has two meshes and a dependent voltage source, so we must write two mesh-current equations and a constraint equation. The reference direction for the mesh currents  $\mathbf{I}_1$  and  $\mathbf{I}_2$  is clockwise, as shown in Fig. 9.37. Once we know  $\mathbf{I}_1$  and  $\mathbf{I}_2$ , we can easily find the unknown voltages. Summing the voltages around mesh 1 gives

$$150 = (1 + j2)\mathbf{I}_1 + (12 - j16)(\mathbf{I}_1 - \mathbf{I}_2),$$

or

$$150 = (13 - j14)\mathbf{I}_1 - (12 - j16)\mathbf{I}_2.$$

Summing the voltages around mesh 2 generates the equation

$$0 = (12 - j16)(\mathbf{I}_2 - \mathbf{I}_1) + (1 + j3)\mathbf{I}_2 + 39\mathbf{I}_x.$$

Figure 9.37 reveals that the controlling current  $\mathbf{I}_x$  is the difference between  $\mathbf{I}_1$  and  $\mathbf{I}_2$ ; that is, the constraint is

$$\mathbf{I}_x = \mathbf{I}_1 - \mathbf{I}_2.$$

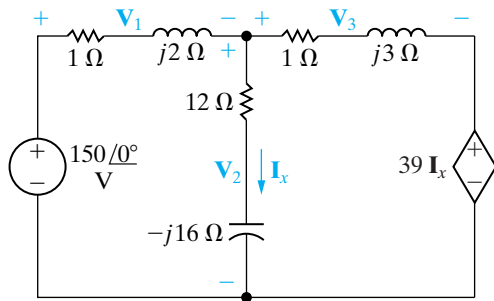


Figure 9.36 ▲ The circuit for Example 9.12.

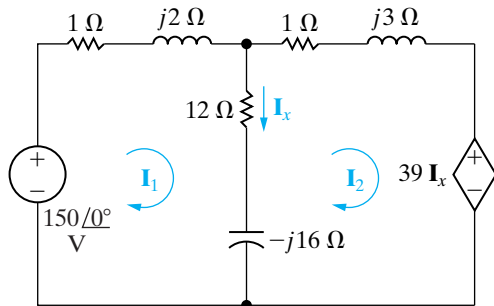


Figure 9.37 ▲ Mesh currents used to solve the circuit shown in Fig. 9.36.

Substituting this constraint into the mesh 2 equation and simplifying the resulting expression gives

$$0 = (27 + j16)\mathbf{I}_1 - (26 + j13)\mathbf{I}_2.$$

Solving for  $\mathbf{I}_1$  and  $\mathbf{I}_2$  yields

$$\mathbf{I}_1 = -26 - j52 \text{ A},$$

$$\mathbf{I}_2 = -24 - j58 \text{ A},$$

$$\mathbf{I}_x = -2 + j6 \text{ A}.$$

The three voltages are

$$\mathbf{V}_1 = (1 + j2)\mathbf{I}_1 = 78 - j104 \text{ V},$$

$$\mathbf{V}_2 = (12 - j16)\mathbf{I}_x = 72 + j104 \text{ V},$$

$$\mathbf{V}_3 = (1 + j3)\mathbf{I}_2 = 150 - j130 \text{ V}.$$

Also

$$39\mathbf{I}_x = -78 + j234 \text{ V}.$$

We check these calculations by summing the voltages around closed paths:

$$\begin{aligned} -150 + \mathbf{V}_1 + \mathbf{V}_2 &= -150 + 78 - j104 + 72 \\ &\quad + j104 = 0, \end{aligned}$$

$$\begin{aligned} -\mathbf{V}_2 + \mathbf{V}_3 + 39\mathbf{I}_x &= -72 - j104 + 150 - j130 \\ &\quad - 78 + j234 = 0, \end{aligned}$$

$$\begin{aligned} -150 + \mathbf{V}_1 + \mathbf{V}_3 + 39\mathbf{I}_x &= -150 + 78 - j104 + 150 \\ &\quad - j130 - 78 + j234 = 0. \end{aligned}$$

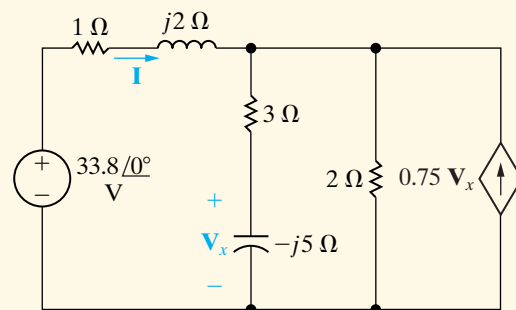
## ASSESSMENT PROBLEM

Objective 3—Know how to use circuit analysis techniques to solve a circuit in the frequency domain

9.13 Use the mesh-current method to find the phasor current  $\mathbf{I}$  in the circuit shown.

Answer:  $\mathbf{I} = 29 + j2 = 29.07 \angle 3.95^\circ \text{ A}$ .

NOTE: Also try Chapter Problems 9.60 and 9.64.



## 9.10 The Transformer

A transformer is a device that is based on magnetic coupling. Transformers are used in both communication and power circuits. In communication circuits, the transformer is used to match impedances and eliminate dc signals from portions of the system. In power circuits, transformers are used to establish ac voltage levels that facilitate the transmission, distribution, and consumption of electrical power. A knowledge of the sinusoidal steady-state

behavior of the transformer is required in the analysis of both communication and power systems. In this section, we will discuss the sinusoidal steady-state behavior of the **linear transformer**, which is found primarily in communication circuits. In Section 9.11, we will deal with the **ideal transformer**, which is used to model the ferromagnetic transformer found in power systems.

Before starting we make a useful observation. When analyzing circuits containing mutual inductance use the mesh or loop-current method for writing circuit equations. The node-voltage method is cumbersome to use when mutual inductance is involved. This is because the currents in the various coils cannot be written by inspection as functions of the node voltages.

## The Analysis of a Linear Transformer Circuit

A simple **transformer** is formed when two coils are wound on a single core to ensure magnetic coupling. Figure 9.38 shows the frequency-domain circuit model of a system that uses a transformer to connect a load to a source. In discussing this circuit, we refer to the transformer winding connected to the source as the **primary winding** and the winding connected to the load as the **secondary winding**. Based on this terminology, the transformer circuit parameters are

- $R_1$  = the resistance of the primary winding,
- $R_2$  = the resistance of the secondary winding,
- $L_1$  = the self-inductance of the primary winding,
- $L_2$  = the self-inductance of the secondary winding,
- $M$  = the mutual inductance.

The internal voltage of the sinusoidal source is  $\mathbf{V}_s$ , and the internal impedance of the source is  $Z_s$ . The impedance  $Z_L$  represents the load connected to the secondary winding of the transformer. The phasor currents  $\mathbf{I}_1$  and  $\mathbf{I}_2$  represent the primary and secondary currents of the transformer, respectively.

Analysis of the circuit in Fig. 9.38 consists of finding  $\mathbf{I}_1$  and  $\mathbf{I}_2$  as functions of the circuit parameters  $\mathbf{V}_s$ ,  $Z_s$ ,  $R_1$ ,  $L_1$ ,  $L_2$ ,  $R_2$ ,  $M$ ,  $Z_L$ , and  $\omega$ . We are also interested in finding the impedance seen looking into the transformer from the terminals a,b. To find  $\mathbf{I}_1$  and  $\mathbf{I}_2$ , we first write the two mesh-current equations that describe the circuit:

$$\mathbf{V}_s = (Z_s + R_1 + j\omega L_1)\mathbf{I}_1 - j\omega M\mathbf{I}_2, \quad (9.57)$$

$$0 = -j\omega M\mathbf{I}_1 + (R_2 + j\omega L_2 + Z_L)\mathbf{I}_2. \quad (9.58)$$

To facilitate the algebraic manipulation of Eqs. 9.57 and 9.58, we let

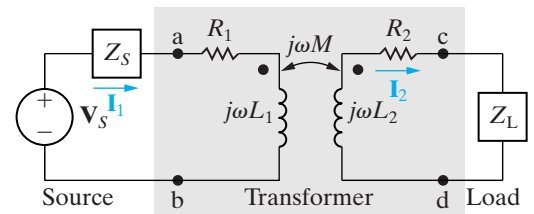
$$Z_{11} = Z_s + R_1 + j\omega L_1, \quad (9.59)$$

$$Z_{22} = R_2 + j\omega L_2 + Z_L, \quad (9.60)$$

where  $Z_{11}$  is the total self-impedance of the mesh containing the primary winding of the transformer, and  $Z_{22}$  is the total self-impedance of the mesh containing the secondary winding. Based on the notation introduced in Eqs. 9.59 and 9.60, the solutions for  $\mathbf{I}_1$  and  $\mathbf{I}_2$  from Eqs. 9.57 and 9.58 are

$$\mathbf{I}_1 = \frac{Z_{22}}{Z_{11}Z_{22} + \omega^2 M^2} \mathbf{V}_s, \quad (9.61)$$

$$\mathbf{I}_2 = \frac{j\omega M}{Z_{11}Z_{22} + \omega^2 M^2} \mathbf{V}_s = \frac{j\omega M}{Z_{22}} \mathbf{I}_1. \quad (9.62)$$



**Figure 9.38** ▲ The frequency domain circuit model for a transformer used to connect a load to a source.

To the internal source voltage  $\mathbf{V}_s$ , the impedance appears as  $\mathbf{V}_s/\mathbf{I}_1$ , or

$$\frac{\mathbf{V}_s}{\mathbf{I}_1} = Z_{\text{int}} = \frac{Z_{11}Z_{22} + \omega^2 M^2}{Z_{22}} = Z_{11} + \frac{\omega^2 M^2}{Z_{22}}. \quad (9.63)$$

The impedance at the terminals of the source is  $Z_{\text{int}} - Z_s$ , so

$$Z_{\text{ab}} = Z_{11} + \frac{\omega^2 M^2}{Z_{22}} - Z_s = R_1 + j\omega L_1 + \frac{\omega^2 M^2}{(R_2 + j\omega L_2 + Z_L)}. \quad (9.64)$$

Note that the impedance  $Z_{\text{ab}}$  is independent of the magnetic polarity of the transformer. The reason is that the mutual inductance appears in Eq. 9.64 as a squared quantity. This impedance is of particular interest because it shows how the transformer affects the impedance of the load as seen from the source. Without the transformer, the load would be connected directly to the source, and the source would see a load impedance of  $Z_L$ ; with the transformer, the load is connected to the source through the transformer, and the source sees a load impedance that is a modified version of  $Z_L$ , as seen in the third term of Eq. 9.64.

### Reflected Impedance

The third term in Eq. 9.64 is called the **reflected impedance** ( $Z_r$ ), because it is the equivalent impedance of the secondary coil and load impedance transmitted, or reflected, to the primary side of the transformer. Note that the reflected impedance is due solely to the existence of mutual inductance; that is, if the two coils are decoupled,  $M$  becomes zero,  $Z_r$  becomes zero, and  $Z_{\text{ab}}$  reduces to the self-impedance of the primary coil.

To consider reflected impedance in more detail, we first express the load impedance in rectangular form:

$$Z_L = R_L + jX_L, \quad (9.65)$$

where the load reactance  $X_L$  carries its own algebraic sign. In other words,  $X_L$  is a positive number if the load is inductive and a negative number if the load is capacitive. We now use Eq. 9.65 to write the reflected impedance in rectangular form:

$$\begin{aligned} Z_r &= \frac{\omega^2 M^2}{R_2 + R_L + j(\omega L_2 + X_L)} \\ &= \frac{\omega^2 M^2 [(R_2 + R_L) - j(\omega L_2 + X_L)]}{(R_2 + R_L)^2 + (\omega L_2 + X_L)^2} \\ &= \frac{\omega^2 M^2}{|Z_{22}|^2} [(R_2 + R_L) - j(\omega L_2 + X_L)]. \end{aligned} \quad (9.66)$$

The derivation of Eq. 9.66 takes advantage of the fact that, when  $Z_L$  is written in rectangular form, the self-impedance of the mesh containing the secondary winding is

$$Z_{22} = R_2 + R_L + j(\omega L_2 + X_L). \quad (9.67)$$

Now observe from Eq. 9.66 that the self-impedance of the secondary circuit is reflected into the primary circuit by a scaling factor of  $(\omega M/|Z_{22}|)^2$ , and that the sign of the reactive component  $(\omega L_2 + X_L)$  is reversed. Thus the linear transformer reflects the conjugate of the self-impedance of the secondary circuit ( $Z_{22}^*$ ) into the primary winding by a scalar multiplier. Example 9.13 illustrates mesh current analysis for a circuit containing a linear transformer.

**Example 9.13 Analyzing a Linear Transformer in the Frequency Domain**

The parameters of a certain linear transformer are  $R_1 = 200 \Omega$ ,  $R_2 = 100 \Omega$ ,  $L_1 = 9 \text{ H}$ ,  $L_2 = 4 \text{ H}$ , and  $k = 0.5$ . The transformer couples an impedance consisting of an  $800 \Omega$  resistor in series with a  $1 \mu\text{F}$  capacitor to a sinusoidal voltage source. The  $300 \text{ V}$  (rms) source has an internal impedance of  $500 + j100 \Omega$  and a frequency of  $400 \text{ rad/s}$ .

- Construct a frequency-domain equivalent circuit of the system.
- Calculate the self-impedance of the primary circuit.
- Calculate the self-impedance of the secondary circuit.
- Calculate the impedance reflected into the primary winding.
- Calculate the scaling factor for the reflected impedance.
- Calculate the impedance seen looking into the primary terminals of the transformer.
- Calculate the Thévenin equivalent with respect to the terminals c,d.

**Solution**

- Figure 9.39 shows the frequency-domain equivalent circuit. Note that the internal voltage of the source serves as the reference phasor, and that  $\mathbf{V}_1$  and  $\mathbf{V}_2$  represent the terminal voltages of the transformer. In constructing the circuit in Fig. 9.39, we made the following calculations:

$$j\omega L_1 = j(400)(9) = j3600 \Omega,$$

$$j\omega L_2 = j(400)(4) = j1600 \Omega,$$

$$M = 0.5\sqrt{(9)(4)} = 3 \text{ H},$$

$$j\omega M = j(400)(3) = j1200 \Omega,$$

$$\frac{1}{j\omega C} = \frac{10^6}{j400} = -j2500 \Omega.$$

- The self-impedance of the primary circuit is

$$Z_{11} = 500 + j100 + 200 + j3600 = 700 + j3700 \Omega.$$

- The self-impedance of the secondary circuit is

$$Z_{22} = 100 + j1600 + 800 - j2500 = 900 - j900 \Omega.$$

- The impedance reflected into the primary winding is

$$\begin{aligned} Z_r &= \left( \frac{1200}{|900 - j900|} \right)^2 (900 + j900) \\ &= \frac{8}{9} (900 + j900) = 800 + j800 \Omega. \end{aligned}$$

- The scaling factor by which  $Z_{22}^*$  is reflected is  $8/9$ .
- The impedance seen looking into the primary terminals of the transformer is the impedance of the primary winding plus the reflected impedance; thus

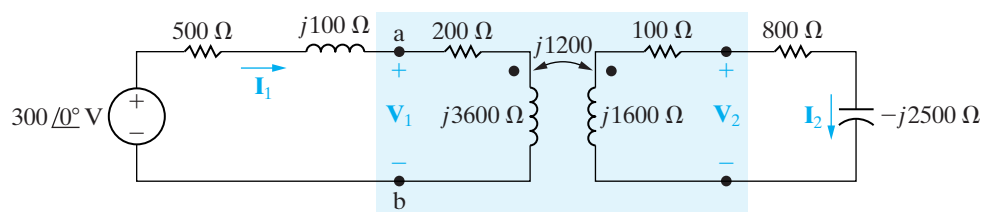
$$Z_{ab} = 200 + j3600 + 800 + j800 = 1000 + j4400 \Omega.$$

- The Thévenin voltage will equal the open circuit value of  $\mathbf{V}_{cd}$ . The open circuit value of  $\mathbf{V}_{cd}$  will equal  $j1200$  times the open circuit value of  $\mathbf{I}_1$ . The open circuit value of  $\mathbf{I}_1$  is

$$\begin{aligned} \mathbf{I}_1 &= \frac{300 \angle 0^\circ}{700 + j3700} \\ &= 79.67 \angle -79.29^\circ \text{ mA}. \end{aligned}$$

Therefore

$$\begin{aligned} \mathbf{V}_{\text{Th}} &= j1200(79.67 \angle -79.29^\circ) \times 10^{-3} \\ &= 95.60 \angle 10.71^\circ \text{ V}. \end{aligned}$$



**Figure 9.39** ▲ The frequency-domain equivalent circuit for Example 9.13.

The Thévenin impedance will be equal to the impedance of the secondary winding plus the impedance reflected from the primary when the voltage source is replaced by a short-circuit. Thus

$$\begin{aligned} Z_{\text{Th}} &= 100 + j1600 + \left( \frac{1200}{|700 + j3700|} \right)^2 (700 - j3700) \\ &= 171.09 + j1224.26 \Omega. \end{aligned}$$

The Thévenin equivalent is shown in Fig. 9.40.

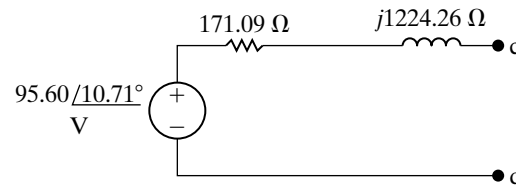
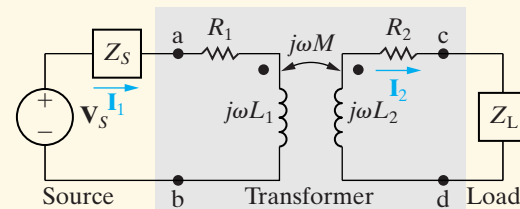


Figure 9.40 ▲ The Thévenin equivalent circuit for Example 9.13.

## ASSESSMENT PROBLEM

**Objective 4—Be able to analyze circuits containing linear transformers using phasor methods**

**9.14** A linear transformer couples a load consisting of a  $360 \Omega$  resistor in series with a  $0.25 \text{ H}$  inductor to a sinusoidal voltage source, as shown. The voltage source has an internal impedance of  $184 + j0 \Omega$  and a maximum voltage of  $245.20 \text{ V}$ , and it is operating at  $800 \text{ rad/s}$ . The transformer parameters are  $R_1 = 100 \Omega$ ,  $L_1 = 0.5 \text{ H}$ ,  $R_2 = 40 \Omega$ ,  $L_2 = 0.125 \text{ H}$ , and  $k = 0.4$ . Calculate (a) the reflected impedance; (b) the primary current; and (c) the secondary current.



**Answer:** (a)  $10.24 - j7.68 \Omega$ ;  
 (b)  $0.5 \cos(800t - 53.13^\circ) \text{ A}$ ;  
 (c)  $0.08 \cos 800t \text{ A}$ .

*NOTE: Also try Chapter Problems 9.76 and 9.77.*

## 9.11 The Ideal Transformer

An **ideal transformer** consists of two magnetically coupled coils having  $N_1$  and  $N_2$  turns, respectively, and exhibiting these three properties:

1. The coefficient of coupling is unity ( $k = 1$ ).
2. The self-inductance of each coil is infinite ( $L_1 = L_2 = \infty$ ).
3. The coil losses, due to parasitic resistance, are negligible.

Understanding the behavior of ideal transformers begins with Eq. 9.64 which describes the impedance at the terminals of a source connected to a linear transformer. We repeat this equation below and examine it further.

### Exploring Limiting Values

A useful relationship between the input impedance and load impedance, as given by  $Z_{\text{ab}}$  in Eq. 9.68, emerges as  $L_1$  and  $L_2$  each become infinitely large and, at the same time, the coefficient of coupling approaches unity:

$$\begin{aligned} Z_{\text{ab}} &= Z_{11} + \frac{\omega^2 M^2}{Z_{22}} - Z_s \\ &= R_1 + j\omega L_1 + \frac{\omega^2 M^2}{(R_2 + j\omega L_2 + Z_L)}. \end{aligned} \quad (9.68)$$

Transformers wound on ferromagnetic cores can approach this condition. Even though such transformers are nonlinear, we can obtain some useful information by constructing an ideal model that ignores the nonlinearities.

To show how  $Z_{ab}$  changes when  $k = 1$  and  $L_1$  and  $L_2$  approach infinity, we first introduce the notation

$$Z_{22} = R_2 + R_L + j(\omega L_2 + X_L) = R_{22} + jX_{22}$$

and then rearrange Eq. 9.68:

$$\begin{aligned} Z_{ab} &= R_1 + \frac{\omega^2 M^2 R_{22}}{R_{22}^2 + X_{22}^2} + j \left( \omega L_1 - \frac{\omega^2 M^2 X_{22}}{R_{22}^2 + X_{22}^2} \right) \\ &= R_{ab} + jX_{ab}. \end{aligned} \quad (9.69)$$

At this point, we must be careful with the coefficient of  $j$  in Eq. 9.69 because, as  $L_1$  and  $L_2$  approach infinity, this coefficient is the difference between two large quantities. Thus, before letting  $L_1$  and  $L_2$  increase, we write the coefficient as

$$X_{ab} = \omega L_1 - \frac{(\omega L_1)(\omega L_2)X_{22}}{R_{22}^2 + X_{22}^2} = \omega L_1 \left( 1 - \frac{\omega L_2 X_{22}}{R_{22}^2 + X_{22}^2} \right), \quad (9.70)$$

where we recognize that, when  $k = 1$ ,  $M^2 = L_1 L_2$ . Putting the term multiplying  $\omega L_1$  over a common denominator gives

$$X_{ab} = \omega L_1 \left( \frac{R_{22}^2 + \omega L_2 X_L + X_L^2}{R_{22}^2 + X_{22}^2} \right). \quad (9.71)$$

Factoring  $\omega L_2$  out of the numerator and denominator of Eq. 9.71 yields

$$X_{ab} = \frac{L_1}{L_2} \frac{X_L + (R_{22}^2 + X_L^2)/\omega L_2}{(R_{22}/\omega L_2)^2 + [1 + (X_L/\omega L_2)]^2}. \quad (9.72)$$

As  $k$  approaches 1.0, the ratio  $L_1/L_2$  approaches the constant value of  $(N_1/N_2)^2$ , which follows from Eqs. 6.54 and 6.55. The reason is that, as the coupling becomes extremely tight, the two permeances  $\mathcal{P}_1$  and  $\mathcal{P}_2$  become equal. Equation 9.72 then reduces to

$$X_{ab} = \left( \frac{N_1}{N_2} \right)^2 X_L, \quad (9.73)$$

as  $L_1 \rightarrow \infty$ ,  $L_2 \rightarrow \infty$ , and  $k \rightarrow 1.0$ .

The same reasoning leads to simplification of the reflected resistance in Eq. 9.69:

$$\frac{\omega^2 M^2 R_{22}}{R_{22}^2 + X_{22}^2} = \frac{L_1}{L_2} R_{22} = \left( \frac{N_1}{N_2} \right)^2 R_{22}. \quad (9.74)$$

Applying the results given by Eqs. 9.73 and 9.74 to Eq. 9.69 yields

$$Z_{ab} = R_1 + \left( \frac{N_1}{N_2} \right)^2 R_2 + \left( \frac{N_1}{N_2} \right)^2 (R_L + jX_L). \quad (9.75)$$

Compare this result with the result in Eq. 9.68. Here we see that when the coefficient of coupling approaches unity and the self-inductances of the coupled coils approach infinity, the transformer reflects the secondary winding resistance and the load impedance to the primary side by a scaling



factor equal to the turns ratio ( $N_1/N_2$ ) squared. Hence we may describe the terminal behavior of the ideal transformer in terms of two characteristics. First, the magnitude of the volts per turn is the same for each coil, or

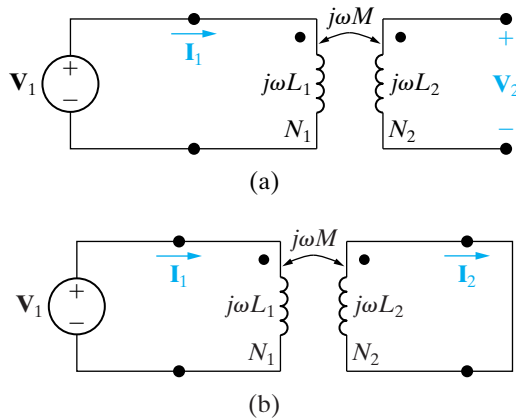
$$\left| \frac{\mathbf{V}_1}{N_1} \right| = \left| \frac{\mathbf{V}_2}{N_2} \right|. \quad (9.76)$$

Second, the magnitude of the ampere-turns is the same for each coil, or

$$|\mathbf{I}_1 N_1| = |\mathbf{I}_2 N_2|. \quad (9.77)$$

We are forced to use magnitude signs in Eqs. 9.76 and 9.77, because we have not yet established reference polarities for the currents and voltages; we discuss the removal of the magnitude signs shortly.

Figure 9.41 shows two lossless ( $R_1 = R_2 = 0$ ) magnetically coupled coils. We use Fig. 9.41 to validate Eqs. 9.76 and 9.77. In Fig. 9.41(a), coil 2 is open; in Fig. 9.41(b), coil 2 is shorted. Although we carry out the following analysis in terms of sinusoidal steady-state operation, the results also apply to instantaneous values of  $v$  and  $i$ .



**Figure 9.41** ▲ The circuits used to verify the volts-per-turn and ampere-turn relationships for an ideal transformer.

### Determining the Voltage and Current Ratios

Note in Fig. 9.41(a) that the voltage at the terminals of the open-circuit coil is entirely the result of the current in coil 1; therefore

$$\mathbf{V}_2 = j\omega M \mathbf{I}_1. \quad (9.78)$$

The current in coil 1 is

$$\mathbf{I}_1 = \frac{\mathbf{V}_1}{j\omega L_1}. \quad (9.79)$$

From Eqs. 9.78 and 9.79,

$$\mathbf{V}_2 = \frac{M}{L_1} \mathbf{V}_1. \quad (9.80)$$

For unity coupling, the mutual inductance equals  $\sqrt{L_1 L_2}$ , so Eq. 9.80 becomes

$$\mathbf{V}_2 = \sqrt{\frac{L_2}{L_1}} \mathbf{V}_1. \quad (9.81)$$

For unity coupling, the flux linking coil 1 is the same as the flux linking coil 2, so we need only one permeance to describe the self-inductance of each coil. Thus Eq. 9.81 becomes

$$\mathbf{V}_2 = \sqrt{\frac{N_2^2 \mathcal{P}}{N_1^2 \mathcal{P}}} \mathbf{V}_1 = \frac{N_2}{N_1} \mathbf{V}_1 \quad (9.82)$$

or

**Voltage relationship for an ideal transformer** ►

$$\frac{\mathbf{V}_1}{N_1} = \frac{\mathbf{V}_2}{N_2}. \quad (9.83)$$

Summing the voltages around the shorted coil of Fig. 9.41(b) yields

$$0 = -j\omega M \mathbf{I}_1 + j\omega L_2 \mathbf{I}_2, \quad (9.84)$$

from which, for  $k = 1$ ,

$$\frac{\mathbf{I}_1}{\mathbf{I}_2} = \frac{L_2}{M} = \frac{L_2}{\sqrt{L_1 L_2}} = \sqrt{\frac{L_2}{L_1}} = \frac{N_2}{N_1} \tag{9.85}$$

Equation 9.85 is equivalent to

$$\mathbf{I}_1 N_1 = \mathbf{I}_2 N_2 \tag{9.86}$$

◀ **Current relationship for an ideal transformer**

Figure 9.42 shows the graphic symbol for an ideal transformer. The vertical lines in the symbol represent the layers of magnetic material from which ferromagnetic cores are often made. Thus, the symbol reminds us that coils wound on a ferromagnetic core behave very much like an ideal transformer.

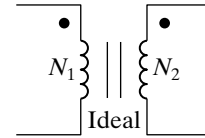


Figure 9.42 ▲ The graphic symbol for an ideal transformer.

There are several reasons for this. The ferromagnetic material creates a space with high permeance. Thus most of the magnetic flux is trapped inside the core material, establishing tight magnetic coupling between coils that share the same core. High permeance also means high self-inductance, because  $L = N^2 \mathcal{P}$ . Finally, ferromagnetically coupled coils efficiently transfer power from one coil to the other. Efficiencies in excess of 95% are common, so neglecting losses is not a crippling approximation for many applications.

### Determining the Polarity of the Voltage and Current Ratios

We now turn to the removal of the magnitude signs from Eqs. 9.76 and 9.77. Note that magnitude signs did not show up in the derivations of Eqs. 9.83 and 9.86. We did not need them there because we had established reference polarities for voltages and reference directions for currents. In addition, we knew the magnetic polarity dots of the two coupled coils.

The rules for assigning the proper algebraic sign to Eqs. 9.76 and 9.77 are as follows:

If the coil voltages  $\mathbf{V}_1$  and  $\mathbf{V}_2$  are both positive or negative at the dot-marked terminal, use a plus sign in Eq. 9.76. Otherwise, use a negative sign.

If the coil currents  $\mathbf{I}_1$  and  $\mathbf{I}_2$  are both directed into or out of the dot-marked terminal, use a minus sign in Eq. 9.77. Otherwise, use a plus sign.

◀ **Dot convention for ideal transformers**

The four circuits shown in Fig. 9.43 illustrate these rules.

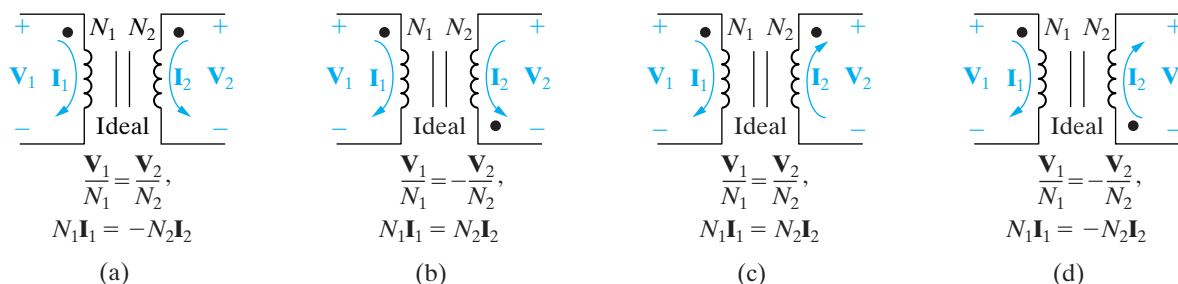
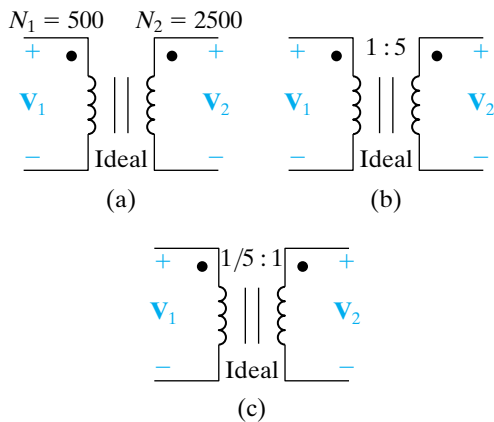


Figure 9.43 ▲ Circuits that show the proper algebraic signs for relating the terminal voltages and currents of an ideal transformer.



**Figure 9.44** ▲ Three ways to show that the turns ratio of an ideal transformer is 5.

The ratio of the turns on the two windings is an important parameter of the ideal transformer. The turns ratio is defined as either  $N_1/N_2$  or  $N_2/N_1$ ; both ratios appear in various writings. In this text, we use  $a$  to denote the ratio  $N_2/N_1$ , or

$$a = \frac{N_2}{N_1}. \quad (9.87)$$

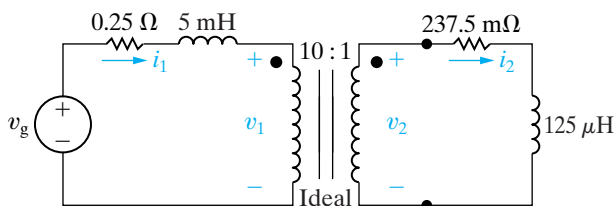
Figure 9.44 shows three ways to represent the turns ratio of an ideal transformer. Figure 9.44(a) shows the number of turns in each coil explicitly. Figure 9.44(b) shows that the ratio  $N_2/N_1$  is 5 to 1, and Fig. 9.44(c) shows that the ratio  $N_2/N_1$  is 1 to  $\frac{1}{5}$ .

Example 9.14 illustrates the analysis of a circuit containing an ideal transformer.

### Example 9.14 Analyzing an Ideal Transformer Circuit in the Frequency Domain

The load impedance connected to the secondary winding of the ideal transformer in Fig. 9.45 consists of a  $237.5 \text{ m}\Omega$  resistor in series with a  $125 \text{ }\mu\text{H}$  inductor.

If the sinusoidal voltage source ( $v_g$ ) is generating the voltage  $2500 \cos 400t \text{ V}$ , find the steady-state expressions for: (a)  $i_1$ ; (b)  $v_1$ ; (c)  $i_2$ ; and (d)  $v_2$ .



**Figure 9.45** ▲ The circuit for Example 9.14.

#### Solution

a) We begin by constructing the phasor domain equivalent circuit. The voltage source becomes  $2500 \angle 0^\circ \text{ V}$ ; the  $5 \text{ mH}$  inductor converts to an impedance of  $j2 \text{ }\Omega$ ; and the  $125 \text{ }\mu\text{H}$  inductor converts to an impedance of  $j0.05 \text{ }\Omega$ . The phasor domain equivalent circuit is shown in Fig. 9.46.

It follows directly from Fig. 9.46 that

$$2500 \angle 0^\circ = (0.25 + j2)\mathbf{I}_1 + \mathbf{V}_1,$$

and

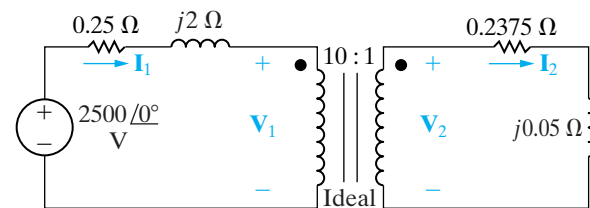
$$\mathbf{V}_1 = 10\mathbf{V}_2 = 10[(0.2375 + j0.05)\mathbf{I}_2].$$

Because

$$\mathbf{I}_2 = 10\mathbf{I}_1$$

we have

$$\begin{aligned} \mathbf{V}_1 &= 10(0.2375 + j0.05)10\mathbf{I}_1 \\ &= (23.75 + j5)\mathbf{I}_1. \end{aligned}$$



**Figure 9.46** ▲ Phasor domain circuit for Example 9.14.

Therefore

$$2500 \angle 0^\circ = (24 + j7)\mathbf{I}_1,$$

or

$$\mathbf{I}_1 = 100 \angle -16.26^\circ \text{ A}.$$

Thus the steady-state expression for  $i_1$  is

$$i_1 = 100 \cos(400t - 16.26^\circ) \text{ A}.$$

$$\begin{aligned} \text{b) } \mathbf{V}_1 &= 2500 \angle 0^\circ - (100 \angle -16.26^\circ)(0.25 + j2) \\ &= 2500 - 80 - j185 \\ &= 2420 - j185 = 2427.06 \angle -4.37^\circ \text{ V}. \end{aligned}$$

Hence

$$v_1 = 2427.06 \cos(400t - 4.37^\circ) \text{ V}.$$

$$\text{c) } \mathbf{I}_2 = 10\mathbf{I}_1 = 1000 \angle -16.26^\circ \text{ A}.$$

Therefore

$$i_2 = 1000 \cos(400t - 16.26^\circ) \text{ A}.$$

$$\text{d) } \mathbf{V}_2 = 0.1\mathbf{V}_1 = 242.71 \angle -4.37^\circ \text{ V},$$

giving

$$v_2 = 242.71 \cos(400t - 4.37^\circ) \text{ V}.$$

## The Use of an Ideal Transformer for Impedance Matching

Ideal transformers can also be used to raise or lower the impedance level of a load. The circuit shown in Fig. 9.47 illustrates this. The impedance seen by the practical voltage source ( $\mathbf{V}_s$  in series with  $Z_s$ ) is  $\mathbf{V}_1/\mathbf{I}_1$ . The voltage and current at the terminals of the load impedance ( $\mathbf{V}_2$  and  $\mathbf{I}_2$ ) are related to  $\mathbf{V}_1$  and  $\mathbf{I}_1$  by the transformer turns ratio; thus

$$\mathbf{V}_1 = \frac{\mathbf{V}_2}{a}, \quad (9.88)$$

and

$$\mathbf{I}_1 = a\mathbf{I}_2. \quad (9.89)$$

Therefore the impedance seen by the practical source is

$$Z_{\text{IN}} = \frac{\mathbf{V}_1}{\mathbf{I}_1} = \frac{1}{a^2} \frac{\mathbf{V}_2}{\mathbf{I}_2}, \quad (9.90)$$

but the ratio  $\mathbf{V}_2/\mathbf{I}_2$  is the load impedance  $Z_L$ , so Eq. 9.90 becomes

$$Z_{\text{IN}} = \frac{1}{a^2} Z_L. \quad (9.91)$$

Thus, the ideal transformer's secondary coil reflects the load impedance back to the primary coil, with the scaling factor  $1/a^2$ .

Note that the ideal transformer changes the magnitude of  $Z_L$  but does not affect its phase angle. Whether  $Z_{\text{IN}}$  is greater or less than  $Z_L$  depends on the turns ratio  $a$ .

The ideal transformer—or its practical counterpart, the ferromagnetic core transformer—can be used to match the magnitude of  $Z_L$  to the magnitude of  $Z_s$ . We will discuss why this may be desirable in Chapter 10.

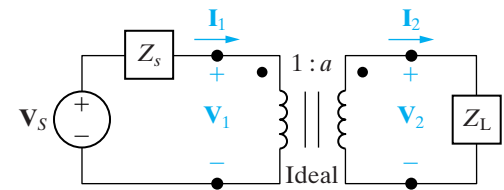


Figure 9.47 ▲ Using an ideal transformer to couple a load to a source.

### ASSESSMENT PROBLEM

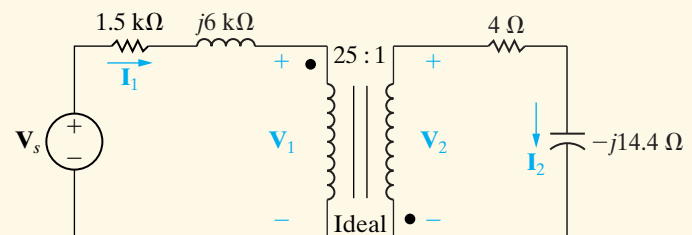
**Objective 5**—Be able to analyze circuits with ideal transformers

**9.15** The source voltage in the phasor domain circuit in the accompanying figure is  $25 \angle 0^\circ$  kV. Find the amplitude and phase angle of  $\mathbf{V}_2$  and  $\mathbf{I}_2$ .

**Answer:**  $\mathbf{V}_2 = 1868.15 \angle 142.39^\circ$  V;

$\mathbf{I}_2 = 125 \angle 216.87^\circ$  A.

*NOTE:* Also try Chapter Problem 9.82.



As we shall see, ideal transformers are used to increase or decrease voltages from a source to a load. Thus, ideal transformers are used widely in the electric utility industry, where it is desirable to decrease, or step down, the voltage level at the power line to safer residential voltage levels.

## 9.12 Phasor Diagrams

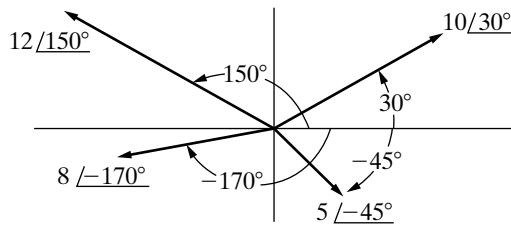


Figure 9.48 ▲ A graphic representation of phasors.

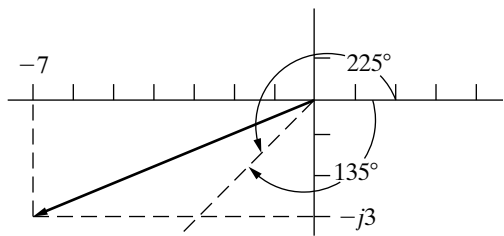


Figure 9.49 ▲ The complex number  $-7 - j3 = 7.62 \angle -156.80^\circ$ .

When we are using the phasor method to analyze the steady-state sinusoidal operation of a circuit, a diagram of the phasor currents and voltages may give further insight into the behavior of the circuit. A phasor diagram shows the magnitude and phase angle of each phasor quantity in the complex-number plane. Phase angles are measured counterclockwise from the positive real axis, and magnitudes are measured from the origin of the axes. For example, Fig. 9.48 shows the phasor quantities  $10 \angle 30^\circ$ ,  $12 \angle 150^\circ$ ,  $5 \angle -45^\circ$ , and  $8 \angle -170^\circ$ .

Constructing phasor diagrams of circuit quantities generally involves both currents and voltages. As a result, two different magnitude scales are necessary, one for currents and one for voltages. The ability to visualize a phasor quantity on the complex-number plane can be useful when you are checking pocket calculator calculations. The typical pocket calculator doesn't offer a printout of the data entered. But when the calculated angle is displayed, you can compare it to your mental image as a check on whether you keyed in the appropriate values. For example, suppose that you are to compute the polar form of  $-7 - j3$ . Without making any calculations, you should anticipate a magnitude greater than 7 and an angle in the third quadrant that is more negative than  $-135^\circ$  or less positive than  $225^\circ$ , as illustrated in Fig. 9.49.

Examples 9.15 and 9.16 illustrate the construction and use of phasor diagrams. We use such diagrams in subsequent chapters whenever they give additional insight into the steady-state sinusoidal operation of the circuit under investigation. Problem 9.84 shows how a phasor diagram can help explain the operation of a phase-shifting circuit.

### Example 9.15 Using Phasor Diagrams to Analyze a Circuit

For the circuit in Fig. 9.50, use a phasor diagram to find the value of  $R$  that will cause the current through that resistor,  $i_R$ , to lag the source current,  $i_s$ , by  $45^\circ$  when  $\omega = 5 \text{ krad/s}$ .

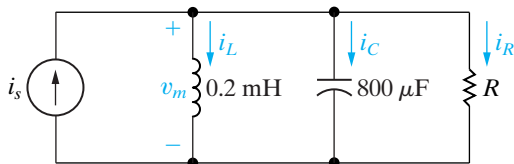


Figure 9.50 ▲ The circuit for Example 9.15.

#### Solution

By Kirchhoff's current law, the sum of the currents  $\mathbf{I}_R$ ,  $\mathbf{I}_L$ , and  $\mathbf{I}_C$  must equal the source current  $\mathbf{I}_s$ . If we assume that the phase angle of the voltage  $\mathbf{V}_m$  is zero, we can draw the current phasors for each of the components. The current phasor for the inductor is given by

$$\mathbf{I}_L = \frac{V_m \angle 0^\circ}{j(5000)(0.2 \times 10^{-3})} = V_m \angle -90^\circ,$$

whereas the current phasor for the capacitor is given by

$$\mathbf{I}_C = \frac{V_m \angle 0^\circ}{-j/(5000)(800 \times 10^{-6})} = 4V_m \angle 90^\circ,$$

and the current phasor for the resistor is given by

$$\mathbf{I}_R = \frac{V_m \angle 0^\circ}{R} = \frac{V_m}{R} \angle 0^\circ.$$

These phasors are shown in Fig. 9.51. The phasor diagram also shows the source current phasor, sketched as a dotted line, which must be the sum of the current phasors of the three circuit components and must be at an angle that is  $45^\circ$  more positive than the current phasor for the resistor. As you can see, summing the phasors makes an isosceles triangle, so the length of the current phasor for the resistor must equal  $3V_m$ . Therefore, the value of the resistor is  $\frac{1}{3} \Omega$ .

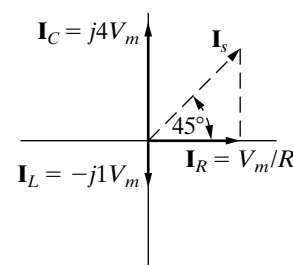
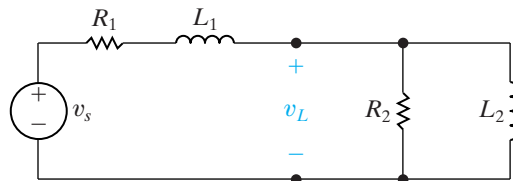


Figure 9.51 ▲ The phasor diagram for the currents in Fig. 9.50.

**Example 9.16** Using Phasor Diagrams to Analyze Capacitive Loading Effects

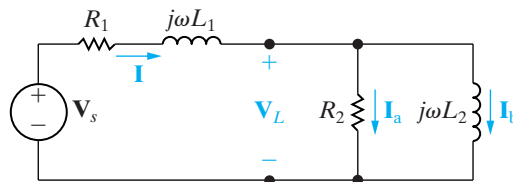
The circuit in Fig. 9.52 has a load consisting of the parallel combination of the resistor and inductor. Use phasor diagrams to explore the effect of adding a capacitor across the terminals of the load on the amplitude of  $\mathbf{V}_s$  if we adjust  $\mathbf{V}_s$  so that the amplitude of  $\mathbf{V}_L$  remains constant. Utility companies use this technique to control the voltage drop on their lines.



**Figure 9.52** ▲ The circuit for Example 9.16.

**Solution**

We begin by assuming zero capacitance across the load. After constructing the phasor diagram for the zero-capacitance case, we can add the capacitor and study its effect on the amplitude of  $\mathbf{V}_s$ , holding the amplitude of  $\mathbf{V}_L$  constant. Figure 9.53 shows the frequency-domain equivalent of the circuit shown in Fig. 9.52. We added the phasor branch currents  $\mathbf{I}$ ,  $\mathbf{I}_a$ , and  $\mathbf{I}_b$  to Fig. 9.53 to aid discussion.



**Figure 9.53** ▲ The frequency-domain equivalent of the circuit in Fig. 9.52.

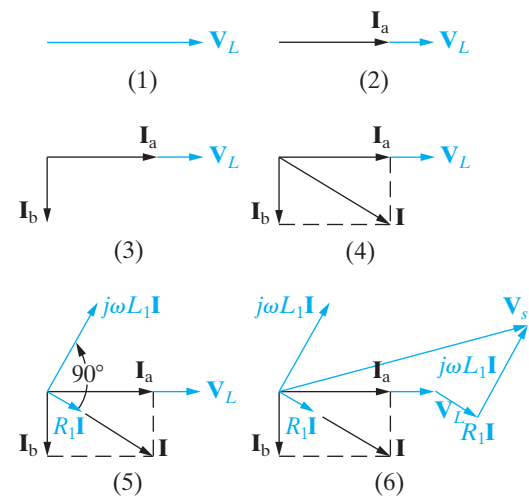
Figure 9.54 shows the stepwise evolution of the phasor diagram. Keep in mind that we are not interested in specific phasor values and positions in this example, but rather in the general effect of adding a capacitor across the terminals of the load. Thus, we want to develop the relative positions of the phasors before and after the capacitor has been added.

Relating the phasor diagram to the circuit shown in Fig. 9.53 reveals the following points:

- a) Because we are holding the amplitude of the load voltage constant, we choose  $\mathbf{V}_L$  as our reference.

For convenience, we place this phasor on the positive real axis.

- b) We know that  $\mathbf{I}_a$  is in phase with  $\mathbf{V}_L$  and that its magnitude is  $|\mathbf{V}_L|/R_2$ . (On the phasor diagram, the magnitude scale for the current phasors is independent of the magnitude scale for the voltage phasors.)
- c) We know that  $\mathbf{I}_b$  lags behind  $\mathbf{V}_L$  by  $90^\circ$  and that its magnitude is  $|\mathbf{V}_L|/\omega L_2$ .
- d) The line current  $\mathbf{I}$  is equal to the sum of  $\mathbf{I}_a$  and  $\mathbf{I}_b$ .
- e) The voltage drop across  $R_1$  is in phase with the line current, and the voltage drop across  $j\omega L_1$  leads the line current by  $90^\circ$ .
- f) The source voltage is the sum of the load voltage and the drop along the line; that is,  $\mathbf{V}_s = \mathbf{V}_L + (R_1 + j\omega L_1)\mathbf{I}$ .



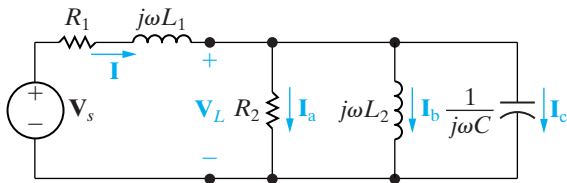
**Figure 9.54** ▲ The step-by-step evolution of the phasor diagram for the circuit in Fig. 9.53.

Note that the completed phasor diagram shown in step 6 of Fig. 9.54 clearly shows the amplitude and phase angle relationships among all the currents and voltages in Fig. 9.53.

Now add the capacitor branch shown in Fig. 9.55. We are holding  $\mathbf{V}_L$  constant, so we construct the phasor diagram for the circuit in Fig. 9.55 following the same steps as those in Fig. 9.54, except that, in step 4, we add the capacitor current  $\mathbf{I}_c$  to the diagram. In so doing,  $\mathbf{I}_c$  leads  $\mathbf{V}_L$  by  $90^\circ$ , with its magnitude being  $|\mathbf{V}_L|\omega C$ . Figure 9.56 shows the effect of  $\mathbf{I}_c$  on the line current: Both the magnitude and phase angle of the line current  $\mathbf{I}$  change with changes in the magnitude of  $\mathbf{I}_c$ . As  $\mathbf{I}$  changes, so do the magnitude and phase angle of the voltage drop along the line. As the drop along the line changes, the magnitude and phase angle of  $\mathbf{V}_s$  change. The phasor diagram shown

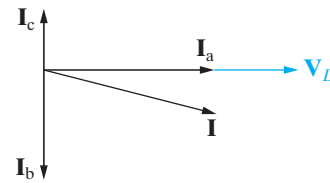
in Fig. 9.57 depicts these observations. The dotted phasors represent the pertinent currents and voltages before the addition of the capacitor.

Thus, comparing the dotted phasors of  $\mathbf{I}$ ,  $R_1\mathbf{I}$ ,  $j\omega L_1\mathbf{I}$ , and  $\mathbf{V}_s$  with their solid counterparts clearly shows the effect of adding  $C$  to the circuit. In particular, note that this reduces the amplitude of the source voltage and still maintains the amplitude of the load voltage. Practically, this result means that, as the load increases (i.e., as  $\mathbf{I}_a$  and  $\mathbf{I}_b$  increase), we can add capacitors to the system (i.e., increase  $\mathbf{I}_c$ ) so that under heavy load conditions we can maintain  $\mathbf{V}_L$  without increasing the amplitude of the source voltage.

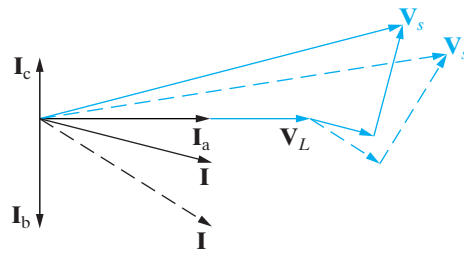


**Figure 9.55** ▲ The addition of a capacitor to the circuit shown in Fig. 9.53.

*NOTE: Assess your understanding of this material by trying Chapter Problems 9.83 and 9.84.*



**Figure 9.56** ▲ The effect of the capacitor current  $\mathbf{I}_c$  on the line current  $\mathbf{I}$ .



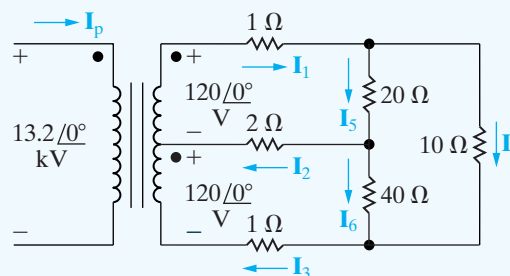
**Figure 9.57** ▲ The effect of adding a load-shunting capacitor to the circuit shown in Fig. 9.53 if  $\mathbf{V}_L$  is held constant.

## Practical Perspective

### A Household Distribution Circuit

Let us return to the household distribution circuit introduced at the beginning of the chapter. We will modify the circuit slightly by adding resistance to each conductor on the secondary side of the transformer to simulate more accurately the residential wiring conductors. The modified circuit is shown in Fig. 9.58. In Problem 9.88 you will calculate the six branch currents on the secondary side of the distribution transformer and then show how to calculate the current in the primary winding.

*NOTE: Assess your understanding of this Practical Perspective by trying Chapter Problems 9.87 and 9.88.*



**Figure 9.58** ▲ Distribution circuit.



## Summary

- The general equation for a **sinusoidal source** is

$$v = V_m \cos(\omega t + \phi) \text{ (voltage source),}$$

or

$$i = I_m \cos(\omega t + \phi) \text{ (current source),}$$

where  $V_m$  (or  $I_m$ ) is the maximum amplitude,  $\omega$  is the frequency, and  $\phi$  is the phase angle. (See page 306.)

- The frequency,  $\omega$ , of a sinusoidal response is the same as the frequency of the sinusoidal source driving the circuit. The amplitude and phase angle of the response are usually different from those of the source. (See page 309.)
- The best way to find the steady-state voltages and currents in a circuit driven by sinusoidal sources is to perform the analysis in the frequency domain. The following mathematical transforms allow us to move between the time and frequency domains.
  - The phasor transform (from the time domain to the frequency domain):

$$\mathbf{V} = V_m e^{j\phi} = \mathcal{P}\{V_m \cos(\omega t + \phi)\}.$$

- The inverse phasor transform (from the frequency domain to the time domain):

$$\mathcal{P}^{-1}\{V_m e^{j\phi}\} = \Re\{V_m e^{j\phi} e^{j\omega t}\}.$$

(See pages 310–311.)

- When working with sinusoidally varying signals, remember that voltage leads current by  $90^\circ$  at the terminals of an inductor, and current leads voltage by  $90^\circ$  at the terminals of a capacitor. (See pages 315–318.)
- Impedance** ( $Z$ ) plays the same role in the frequency domain as resistance, inductance, and capacitance play in the time domain. Specifically, the relationship between phasor current and phasor voltage for resistors, inductors, and capacitors is

$$\mathbf{V} = Z\mathbf{I},$$

where the reference direction for  $\mathbf{I}$  obeys the passive sign convention. The reciprocal of impedance is **admittance** ( $Y$ ), so another way to express the current-voltage relationship for resistors, inductors, and capacitors in the frequency domain is

$$\mathbf{V} = \mathbf{I}/Y.$$

(See pages 318 and 322.)

- All of the circuit analysis techniques developed in Chapters 2–4 for resistive circuits also apply to sinusoidal steady-state circuits in the frequency domain. These techniques include KVL, KCL, series, and parallel combinations of impedances, voltage and current division, node voltage and mesh current methods, source transformations and Thévenin and Norton equivalents.
- The two-winding **linear transformer** is a coupling device made up of two coils wound on the same nonmagnetic core. **Reflected impedance** is the impedance of the secondary circuit as seen from the terminals of the primary circuit or vice versa. The reflected impedance of a linear transformer seen from the primary side is the conjugate of the self-impedance of the secondary circuit scaled by the factor  $(\omega M/|Z_{22}|)^2$ . (See pages 333 and 334.)
- The two-winding **ideal transformer** is a linear transformer with the following special properties: perfect coupling ( $k = 1$ ), infinite self-inductance in each coil ( $L_1 = L_2 = \infty$ ), and lossless coils ( $R_1 = R_2 = 0$ ). The circuit behavior is governed by the turns ratio  $a = N_2/N_1$ . In particular, the volts per turn is the same for each winding, or

$$\frac{\mathbf{V}_1}{N_1} = \pm \frac{\mathbf{V}_2}{N_2},$$

and the ampere turns are the same for each winding, or

$$N_1\mathbf{I}_1 = \pm N_2\mathbf{I}_2.$$

(See page 338.)

**TABLE 9.3** Impedance and Related Values

Element	Impedance ( $Z$ )	Reactance	Admittance ( $Y$ )	Susceptance
Resistor	$R$ (resistance)	—	$G$ (conductance)	—
Capacitor	$j(-1/\omega C)$	$-1/\omega C$	$j\omega C$	$\omega C$
Inductor	$j\omega L$	$\omega L$	$j(-1/\omega L)$	$-1/\omega L$

## Problems

### Section 9.1

9.1 A sinusoidal current is given by the expression

$$i = 125 \cos(800t + 36.87^\circ) \text{ mA.}$$

Find (a)  $f$  in hertz; (b)  $T$  in milliseconds; (c)  $I_m$ ; (d)  $i(0)$ ; (e)  $\phi$  in degrees and radians; (f) the smallest positive value of  $t$  at which  $i = 0$ ; and (g) the smallest positive value of  $t$  at which  $di/dt = 0$ .

9.2 In a single graph, sketch  $v = 100 \cos(\omega t + \phi)$  versus  $\omega t$  for  $\phi = 90^\circ, 45^\circ, 0^\circ, -45^\circ,$  and  $-90^\circ$ .

- State whether the voltage function is shifting to the right or left as  $\phi$  becomes more negative.
- What is the direction of shift if  $\phi$  changes from 0 to  $45^\circ$ ?

9.3 Consider the sinusoidal voltage

$$v(t) = 25 \cos(400\pi t + 60^\circ) \text{ V.}$$

- What is the maximum amplitude of the voltage?
- What is the frequency in hertz?
- What is the frequency in radians per second?
- What is the phase angle in radians?
- What is the phase angle in degrees?
- What is the period in milliseconds?
- What is the first time after  $t = 0$  that  $v = 0$  V?
- The sinusoidal function is shifted  $5/6$  ms to the right along the time axis. What is the expression for  $v(t)$ ?
- What is the minimum number of milliseconds that the function must be shifted to the left if the expression for  $v(t)$  is  $25 \sin 400\pi t$  V?

9.4 A sinusoidal voltage is zero at  $t = (40/3)$  ms and increasing at a rate of  $750\pi$  V/s. The maximum amplitude of the voltage is 50 V.

- What is the frequency of  $v$  in radians per second?
- What is the expression for  $v$ ?

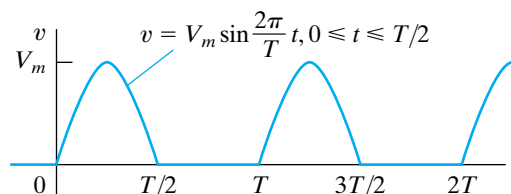
9.5 At  $t = 5$  ms, a sinusoidal current is known to be zero and going negative. The current is next zero at  $t = 25$  ms. It is also known that the current is 50 mA at  $t = 0$ .

- What is the frequency of  $i$  in hertz?
- What is the expression for  $i$ ?

9.6 The rms value of the sinusoidal voltage supplied to the convenience outlet of a home in Scotland is 240 V. What is the maximum value of the voltage at the outlet?

9.7 Find the rms value of the half-wave rectified sinusoidal voltage shown in Fig. P9.7.

Figure P9.7



9.8 Show that

$$\int_{t_0}^{t_0+T} V_m^2 \cos^2(\omega t + \phi) dt = \frac{V_m^2 T}{2}$$

### Section 9.2

9.9 The voltage applied to the circuit shown in Fig. 9.5 at  $t = 0$  is  $75 \cos(4000t - 60^\circ)$  V. The circuit resistance is  $400 \Omega$  and the initial current in the 75 mH inductor is zero.

- Find  $i(t)$  for  $t \geq 0$ .
- Write the expressions for the transient and steady-state components of  $i(t)$ .
- Find the numerical value of  $i$  after the switch has been closed for  $750 \mu\text{s}$ .
- What are the maximum amplitude, frequency (in radians per second), and phase angle of the steady-state current?
- By how many degrees are the voltage and the steady-state current out of phase?

9.10 a) Verify that Eq. 9.9 is the solution of Eq. 9.8. This can be done by substituting Eq. 9.9 into the left-hand side of Eq. 9.8 and then noting that it equals the right-hand side for all values of  $t > 0$ . At  $t = 0$ , Eq. 9.9 should reduce to the initial value of the current.

- Because the transient component vanishes as time elapses and because our solution must satisfy the differential equation for all values of  $t$ , the steady-state component, by itself, must also satisfy the differential equation. Verify this observation by showing that the steady-state component of Eq. 9.9 satisfies Eq. 9.8.

### Sections 9.3–9.4

9.11 Use the concept of the phasor to combine the following sinusoidal functions into a single trigonometric expression:

- $y = 30 \cos(200t - 160^\circ) + 15 \cos(200t + 70^\circ)$ ,
- $y = 90 \sin(50t - 20^\circ) + 60 \cos(200t - 70^\circ)$ ,

- c)  $y = 50 \cos(5000t - 60^\circ) + 25 \sin(5000t + 110^\circ) - 75 \cos(5000t - 30^\circ)$ ,  
 d)  $y = 10 \cos(\omega t + 30^\circ) + 10 \sin \omega t + 10 \cos(\omega t + 150^\circ)$ .

**9.12** A 400 Hz sinusoidal voltage with a maximum amplitude of 100 V at  $t = 0$  is applied across the terminals of an inductor. The maximum amplitude of the steady-state current in the inductor is 20 A.

- What is the frequency of the inductor current?
- If the phase angle of the voltage is zero, what is the phase angle of the current?
- What is the inductive reactance of the inductor?
- What is the inductance of the inductor in millihenrys?
- What is the impedance of the inductor?

**9.13** A 80 kHz sinusoidal voltage has zero phase angle and a maximum amplitude of 25 mV. When this voltage is applied across the terminals of a capacitor, the resulting steady-state current has a maximum amplitude of  $628.32 \mu\text{A}$ .

- What is the frequency of the current in radians per second?
- What is the phase angle of the current?
- What is the capacitive reactance of the capacitor?
- What is the capacitance of the capacitor in microfarads?
- What is the impedance of the capacitor?

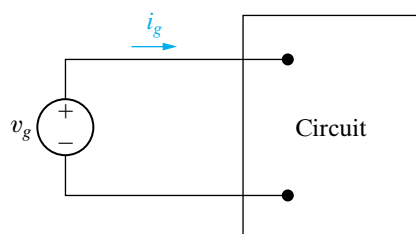
**9.14** The expressions for the steady-state voltage and current at the terminals of the circuit seen in Fig. P9.14 are

$$v_g = 300 \cos(5000\pi t + 78^\circ) \text{ V},$$

$$i_g = 6 \sin(5000\pi t + 123^\circ) \text{ A}$$

- What is the impedance seen by the source?
- By how many microseconds is the current out of phase with the voltage?

Figure P9.14



### Sections 9.5 and 9.6

**9.15** A 25  $\Omega$  resistor, a 50 mH inductor, and a 32  $\mu\text{F}$  capacitor are connected in series. The series-connected

elements are energized by a sinusoidal voltage source whose voltage is  $25 \cos(500t - 60^\circ) \text{ V}$ .

- Draw the frequency-domain equivalent circuit.
- Reference the current in the direction of the voltage rise across the source, and find the phasor current.
- Find the steady-state expression for  $i(t)$ .

**9.16** A 25  $\Omega$  resistor and a 10 mH inductor are connected in parallel. This parallel combination is also in parallel with the series combination of a 30  $\Omega$  resistor and a 10  $\mu\text{F}$  capacitor. These three parallel branches are driven by a sinusoidal current source whose current is  $125 \sin(2500t + 60^\circ) \text{ A}$ .

- Draw the frequency-domain equivalent circuit.
- Reference the voltage across the current source as a rise in the direction of the source current, and find the phasor voltage.
- Find the steady-state expression for  $v(t)$ .

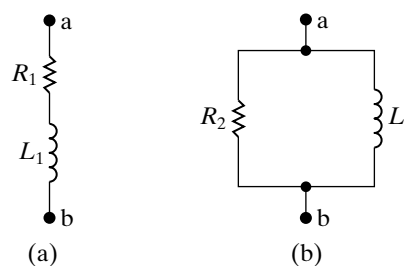
**9.17** Three branches having impedances of  $3 + j4 \Omega$ ,  $16 - j12 \Omega$ , and  $-j4 \Omega$ , respectively, are connected in parallel. What are the equivalent (a) admittance, (b) conductance, and (c) susceptance of the parallel connection in millisiemens? (d) If the parallel branches are excited from a sinusoidal current source where  $i = 8 \cos \omega t \text{ A}$ , what is the maximum amplitude of the current in the purely capacitive branch?

**9.18** a) Show that, at a given frequency  $\omega$ , the circuits in Fig. P9.18(a) and (b) will have the same impedance between the terminals a,b if

$$R_1 = \frac{\omega^2 L_2^2 R_2}{R_2^2 + \omega^2 L_2^2}, \quad L_1 = \frac{R_2^2 L_2}{R_2^2 + \omega^2 L_2^2}.$$

- b) Find the values of resistance and inductance that when connected in series will have the same impedance at 4 krad/s as that of a 5 k $\Omega$  resistor connected in parallel with a 1.25 H inductor.

Figure P9.18



**9.19** a) Show that at a given frequency  $\omega$ , the circuits in Fig. P9.19(a) and (b) will have the same impedance between the terminals a,b if

$$R_2 = \frac{R_1^2 + \omega^2 L_1^2}{R_1}, \quad L_2 = \frac{R_1^2 + \omega^2 L_1^2}{\omega^2 L_1}.$$

(Hint: The two circuits will have the same impedance if they have the same admittance.)

- b) Find the values of resistance and inductance that when connected in parallel will have the same impedance at 1 krad/s as an 8 kΩ resistor connected in series with a 4 H inductor.

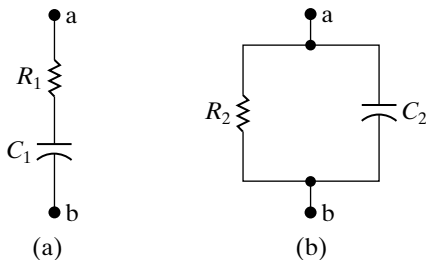
- 9.20 a) Show that at a given frequency  $\omega$ , the circuits in Fig. P9.20(a) and (b) will have the same impedance between the terminals a,b if

$$R_1 = \frac{R_2}{1 + \omega^2 R_2^2 C_2^2},$$

$$C_1 = \frac{1 + \omega^2 R_2^2 C_2^2}{\omega^2 R_2^2 C_2}.$$

- b) Find the values of resistance and capacitance that when connected in series will have the same impedance at 40 krad/s as that of a 1000 Ω resistor connected in parallel with a 50 nF capacitor.

Figure P9.20



- 9.21 a) Show that at a given frequency  $\omega$ , the circuits in Fig 9.20(a) and (b) will have the same impedance between the terminals a,b if

$$R_2 = \frac{1 + \omega^2 R_1^2 C_1^2}{\omega^2 R_1 C_1^2},$$

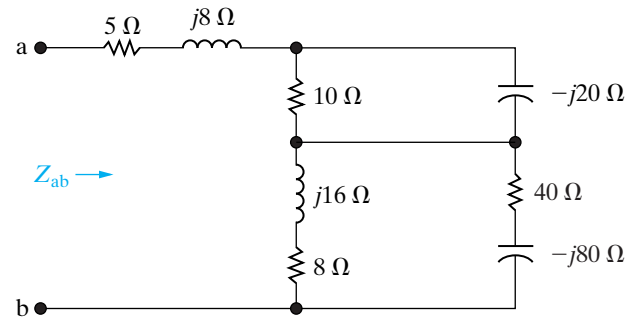
$$C_2 = \frac{C_1}{1 + \omega^2 R_1^2 C_1^2}.$$

(Hint: The two circuits will have the same impedance if they have the same admittance.)

- b) Find the values of resistance and capacitance that when connected in parallel will give the same impedance at 50 krad/s as that of a 1 kΩ resistor connected in series with a capacitance of 40 nF.

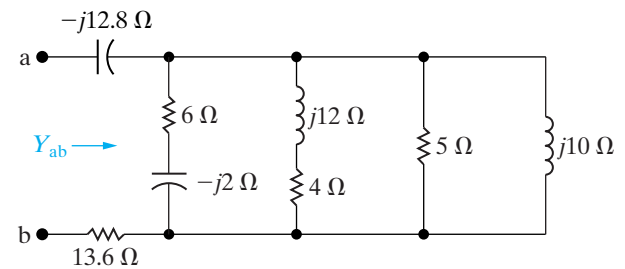
- 9.22 Find the impedance  $Z_{ab}$  in the circuit seen in Fig. P9.22. Express  $Z_{ab}$  in both polar and rectangular form.

Figure P9.22



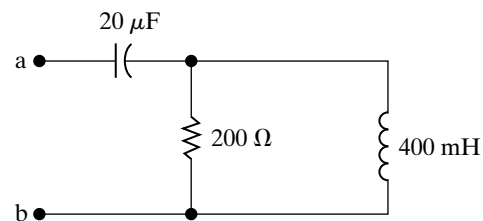
- 9.23 Find the admittance  $Y_{ab}$  in the circuit seen in Fig. P9.23. Express  $Y_{ab}$  in both polar and rectangular form. Give the value of  $Y_{ab}$  in millisiemens.

Figure P9.23



- 9.24 a) For the circuit shown in Fig. P9.24, find the frequency (in radians per second) at which the impedance  $Z_{ab}$  is purely resistive.  
 PSPICE MULTISIM  
 b) Find the value of  $Z_{ab}$  at the frequency of (a).

Figure P9.24



- 9.25 a) Using component values from Appendix H, combine at least one resistor, inductor, and capacitor in series to create an impedance of  $300 - j400 \Omega$  at a frequency of 10,000 rad/s.  
 b) At what frequency does the circuit from part (a) have an impedance that is purely resistive?
- 9.26 a) Using component values from Appendix H, combine at least one resistor and one inductor in parallel to create an impedance of  $40 + j20 \Omega$  at a frequency of 5000 rad/s. (Hint: Use the results of Problem 9.19.)  
 b) Using component values from Appendix H, combine at least one resistor and one capacitor in parallel to create an impedance of  $40 - j20 \Omega$  at a frequency of 5000 rad/s. (Hint: Use the result of Problem 9.21.)

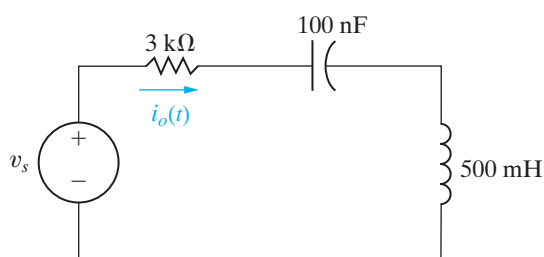
**9.27** a) Using component values from Appendix H, find a single capacitor or a network of capacitors that, when combined in parallel with the  $RL$  circuit from Problem 9.26(a), gives an equivalent impedance that is purely resistive at a frequency of 5000 rad/s.

b) Using component values from Appendix H, find a single inductor or a network of inductors that, when combined in parallel with the  $RC$  circuit from Problem 9.26(b), gives an equivalent impedance that is purely resistive at a frequency of 5000 rad/s.

**9.28** Find the steady-state expression for  $i_o(t)$  in the circuit in Fig. P9.28 if  $v_s = 80 \cos 2000t$  V.

PSPICE  
MULTISIM

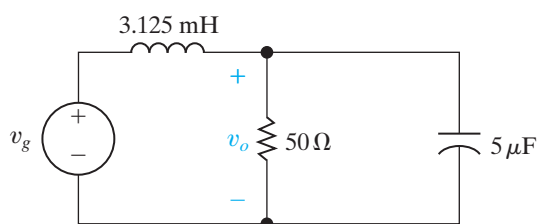
Figure P9.28



**9.29** The circuit in Fig. P9.29 is operating in the sinusoidal steady state. Find the steady-state expression for  $v_o(t)$  if  $v_g = 60 \sin 8000t$  V.

PSPICE  
MULTISIM

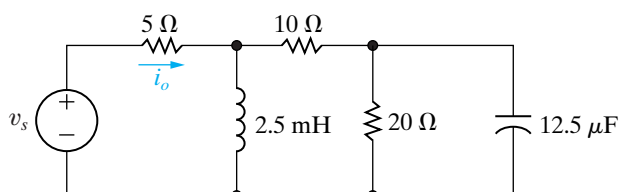
Figure P9.29



**9.30** The circuit in Fig. P9.30 is operating in the sinusoidal steady state. Find  $i_o(t)$  if  $v_s(t) = 25 \sin 4000t$  V.

PSPICE  
MULTISIM

Figure P9.30

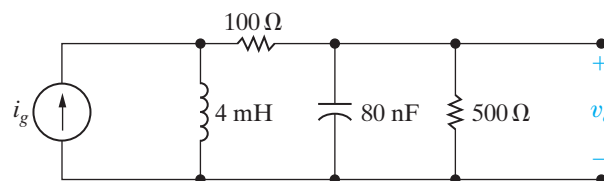


**9.31** a) For the circuit shown in Fig. P9.31, find the steady-state expression for  $v_o$  if  $i_g = 25 \cos 50,000t$  mA.

PSPICE  
MULTISIM

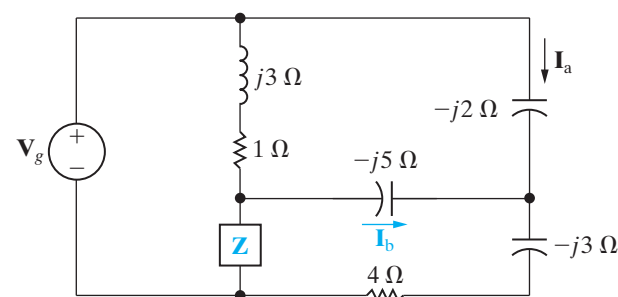
b) By how many microseconds does  $v_o$  lead  $i_g$ ?

Figure P9.31



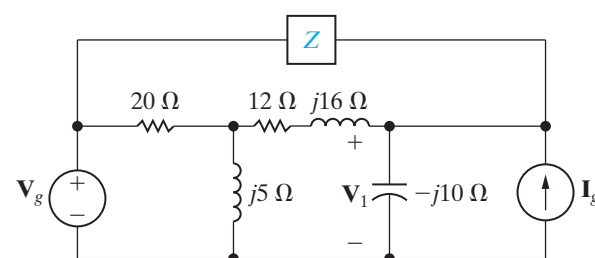
**9.32** Find  $\mathbf{I}_b$  and  $\mathbf{Z}$  in the circuit shown in Fig. P9.32 if  $\mathbf{V}_g = 25 \angle 0^\circ$  V and  $\mathbf{I}_a = 5 \angle 90^\circ$  A.

Figure P9.32



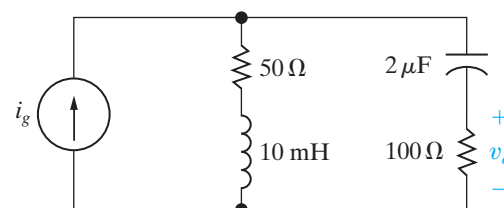
**9.33** Find the value of  $\mathbf{Z}$  in the circuit seen in Fig. P9.33 if  $\mathbf{V}_g = 100 - j50$  V,  $\mathbf{I}_g = 30 + j20$  A, and  $\mathbf{V}_1 = 140 + j30$  V.

Figure P9.33



**9.34** Find the steady-state expression for  $v_o$  in the circuit of Fig. P9.34 if  $i_g = 60 \cos 10,000t$  mA.

Figure P9.34

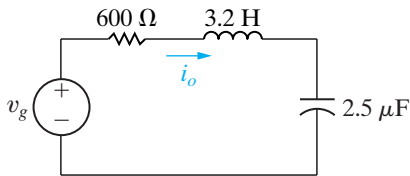


**9.35** The circuit shown in Fig. P9.35 is operating in the sinusoidal steady state. Find the value of  $\omega$  if

$$i_o = 40 \sin(\omega t + 21.87^\circ) \text{ mA,}$$

$$v_g = 40 \cos(\omega t - 15^\circ) \text{ V.}$$

Figure P9.35

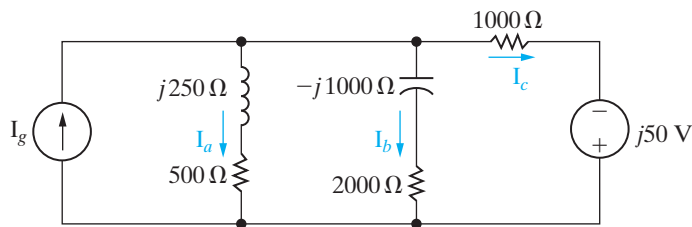


**9.36** The phasor current  $\mathbf{I}_b$  in the circuit shown in Fig. P9.36 is  $25 \angle 0^\circ$  mA.

PSPICE  
MULTISIM

- Find  $\mathbf{I}_a$ ,  $\mathbf{I}_c$ , and  $\mathbf{I}_g$ .
- If  $\omega = 1500$  rad/s, write expressions for  $i_a(t)$ ,  $i_c(t)$ , and  $i_g(t)$ .

Figure P9.36

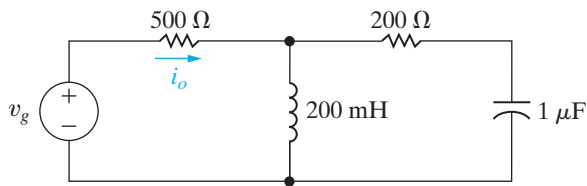


**9.37** The frequency of the sinusoidal voltage source in the circuit in Fig. P9.37 is adjusted until the current  $i_o$  is in phase with  $v_g$ .

PSPICE  
MULTISIM

- Find the frequency in hertz.
- Find the steady-state expression for  $i_g$  (at the frequency found in [a]) if  $v_g = 90 \cos \omega t$  V.

Figure P9.37

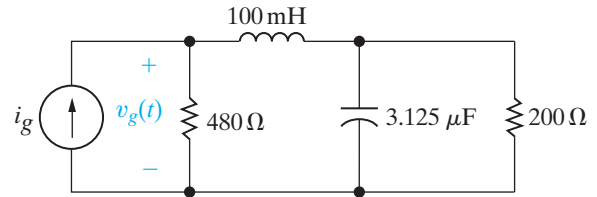


**9.38** a) The frequency of the source voltage in the circuit in Fig. P9.38 is adjusted until  $v_g$  is in phase with  $i_g$ . What is the value of  $\omega$  in radians per second?

PSPICE  
MULTISIM

- If  $i_g = 60 \cos \omega t$  mA (where  $\omega$  is the frequency found in [a]), what is the steady-state expression for  $v_g$ ?

Figure P9.38

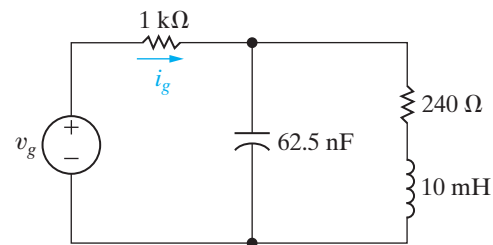


**9.39** The frequency of the sinusoidal voltage source in the circuit in Fig. P9.39 is adjusted until  $i_g$  is in phase with  $v_g$ .

PSPICE  
MULTISIM

- What is the value of  $\omega$  in radians per second?
- If  $v_g = 15 \cos \omega t$  V (where  $\omega$  is the frequency found in [a]), what is the steady-state expression for  $i_g$ ?

Figure P9.39

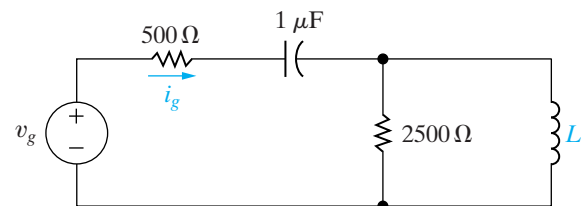


**9.40** a) The source voltage in the circuit in Fig. P9.40 is  $v_g = 40 \cos 1000t$  V. Find the values of  $L$  such that  $i_g$  is in phase with  $v_g$  when the circuit is operating in the steady state.

PSPICE  
MULTISIM

- For the values of  $L$  found in (a), find the steady-state expressions for  $i_g$ .

Figure P9.40



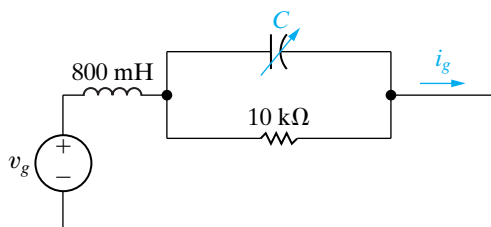
**9.41** The circuit shown in Fig. P9.41 is operating in the sinusoidal steady state. The capacitor is adjusted until the current  $i_g$  is in phase with the sinusoidal voltage  $v_g$ .

PSPICE  
MULTISIM

- Specify the capacitance in microfarads if  $v_g = 80 \cos 5000t$  V.
- Give the steady-state expression for  $i_g$  when  $C$  has the value found in (a).

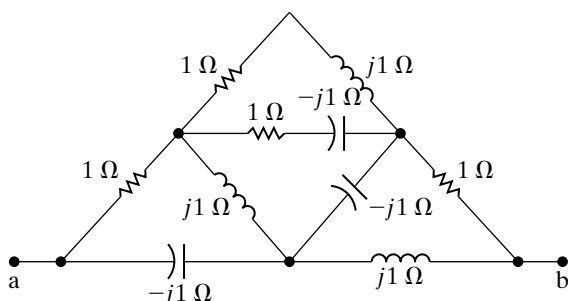


Figure P9.41



9.42 Find  $Z_{ab}$  for the circuit shown in Fig P9.42.

Figure P9.42

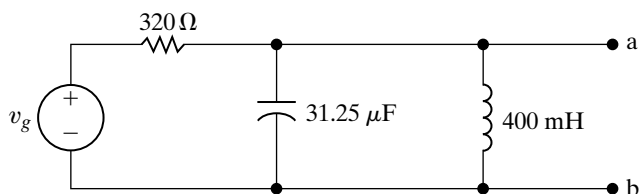


### Section 9.7

9.43 The sinusoidal voltage source in the circuit in Fig. P9.43 is developing a voltage equal to  $50 \sin 400t$  V.

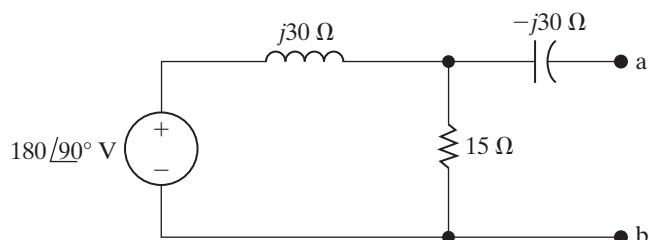
- Find the Thévenin voltage with respect to the terminals a,b.
- Find the Thévenin impedance with respect to the terminals a,b.
- Draw the Thévenin equivalent.

Figure P9.43



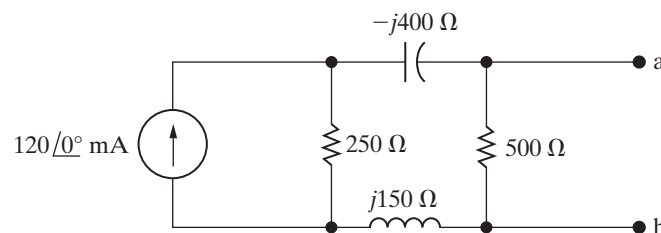
9.44 Use source transformations to find the Norton equivalent circuit with respect to the terminals a,b for the circuit shown in Fig. P9.44.

Figure P9.44



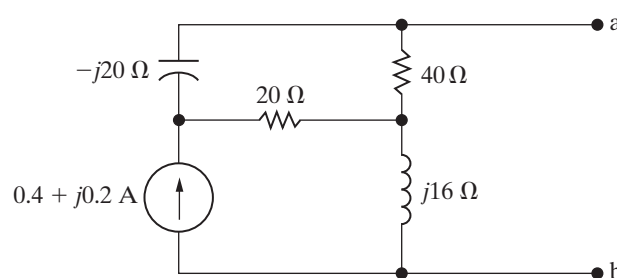
9.45 Use source transformations to find the Thévenin equivalent circuit with respect to the terminals a,b for the circuit shown in Fig. P9.45.

Figure P9.45



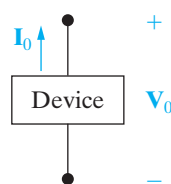
9.46 Find the Norton equivalent circuit with respect to the terminals a,b for the circuit shown in Fig. P9.46.

Figure P9.46



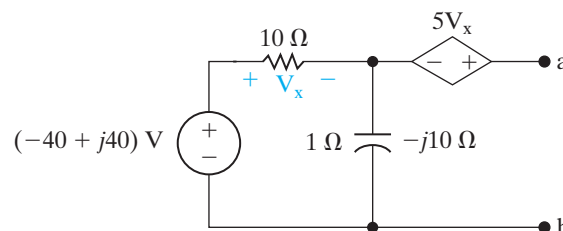
9.47 The device in Fig. P9.47 is represented in the frequency domain by a Thévenin equivalent. When a resistor having an impedance of  $200 \Omega$  is connected across the device, the value of  $I_0$  is  $(-150 + j150)$  mA. When an inductor having an impedance of  $j200 \Omega$  is connected across the device, the value of  $V_0$  is  $(-40 - j40)$  V. Find the Thévenin voltage  $V_{Th}$  and the Thévenin impedance  $Z_{Th}$ .

Figure P9.47



9.48 Find the Norton equivalent with respect to terminals a,b in the circuit of Fig. P9.48.

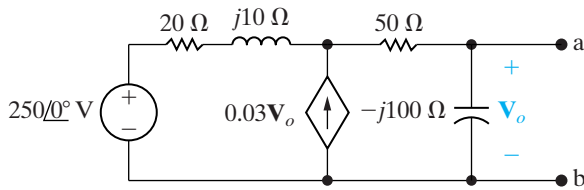
Figure P9.48





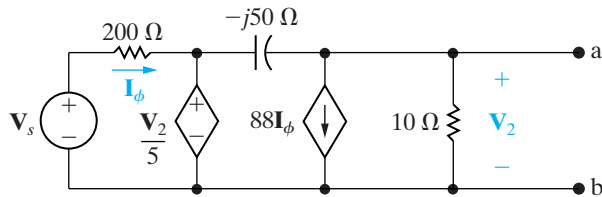
9.49 Find the Thévenin equivalent circuit with respect to the terminals a,b of the circuit shown in Fig. P9.49.

Figure P9.49



9.50 Find the Norton equivalent circuit with respect to the terminals a,b for the circuit shown in Fig. P9.50 when  $V_s = 5\angle 0^\circ$  V.

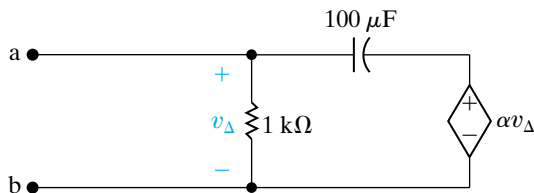
Figure P9.50



9.51 The circuit shown in Fig. P9.51 is operating at a frequency of 10 rad/s. Assume  $\alpha$  is real and lies between  $-10$  and  $+10$ , that is,  $-10 \leq \alpha \leq 10$ .

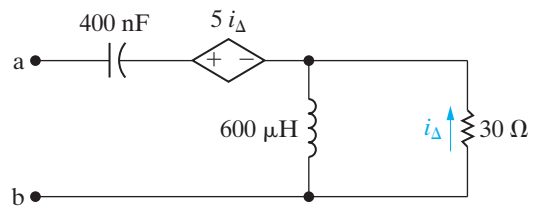
- Find the value of  $\alpha$  so that the Thévenin impedance looking into the terminals a,b is purely resistive.
- What is the value of the Thévenin impedance for the  $\alpha$  found in (a)?
- Can  $\alpha$  be adjusted so that the Thévenin impedance equals  $500 - j500 \Omega$ ? If so, what is the value of  $\alpha$ ?
- For what values of  $\alpha$  will the Thévenin impedance be inductive?

Figure P9.51



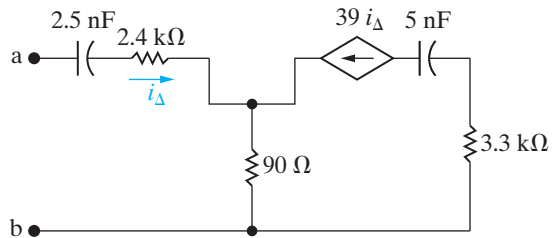
9.52 Find  $Z_{ab}$  in the circuit shown in Fig. P9.52 when the circuit is operating at a frequency of 100 krad/s.

Figure P9.52



9.53 Find the Thévenin impedance seen looking into the terminals a,b of the circuit in Fig. P9.53 if the frequency of operation is  $(25/\pi)$  kHz.

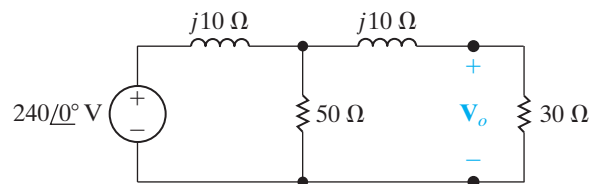
Figure P9.53



Section 9.8

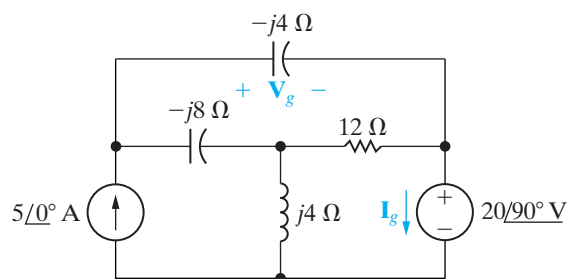
9.54 Use the node-voltage method to find  $V_o$  in the circuit in Fig. P9.54.

Figure P9.54



9.55 Use the node-voltage method to find the phasor voltage  $V_g$  in the circuit shown in Fig. P9.55.

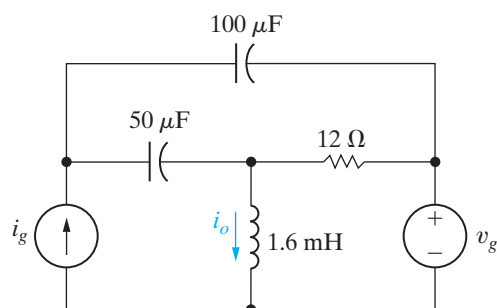
Figure P9.55



- 9.56** Use the node voltage method to find the steady-state expression for  $i_o$  in the circuit seen in Fig. P9.56 if  $i_g = 5 \cos 2500t$  A and  $v_g = 20 \cos (2500t + 90^\circ)$  V.

PSPICE  
MULTISIM

Figure P9.56



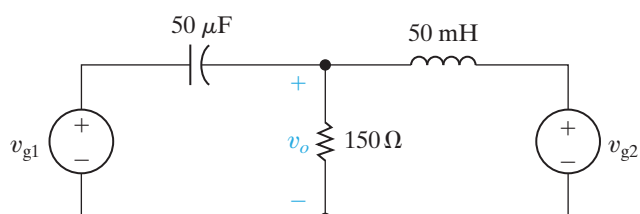
- 9.57** Use the node-voltage method to find the steady-state expression for  $v_o(t)$  in the circuit in Fig. P9.57 if

PSPICE  
MULTISIM

$$v_{g1} = 25 \sin (400t + 143.13^\circ) \text{ V},$$

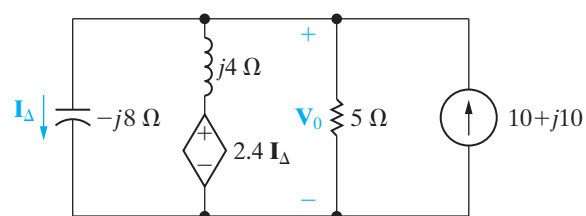
$$v_{g2} = 18.03 \cos (400t + 33.69^\circ) \text{ V}.$$

Figure P9.57



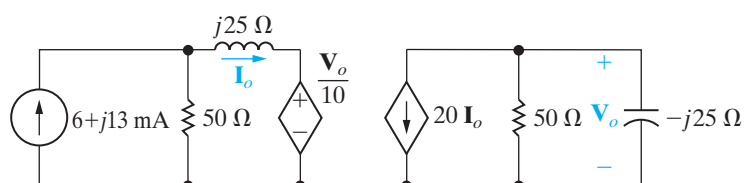
- 9.58** Use the node-voltage method to find the phasor voltage  $\mathbf{V}_o$  in the circuit shown in Fig. P9.58. Express the voltage in both polar and rectangular form.

Figure P9.58



- 9.59** Use the node-voltage method to find  $\mathbf{V}_o$  and  $\mathbf{I}_o$  in the circuit seen in Fig. P9.59.

Figure P9.59



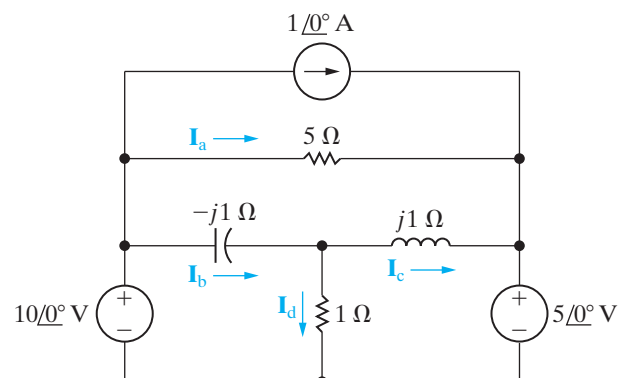
## Section 9.9

- 9.60** Use the mesh-current method to find the phasor current  $\mathbf{I}_g$  in the circuit in Fig. P9.55.

- 9.61** Use the mesh-current method to find the steady-state expression for  $v_o(t)$  in the circuit in Fig. P9.57.

- 9.62** Use the mesh-current method to find the branch currents  $\mathbf{I}_a$ ,  $\mathbf{I}_b$ ,  $\mathbf{I}_c$ , and  $\mathbf{I}_d$  in the circuit shown in Fig. P9.62.

Figure P9.62

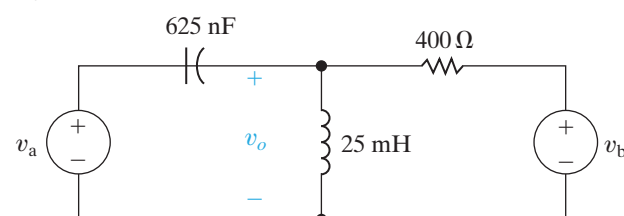


- 9.63** Use the mesh-current method to find the steady-state expression for  $v_o(t)$  in the circuit in Fig. P9.63 if

$$v_a = 18 \sin 4000t \text{ V},$$

$$v_b = 12 \cos 4000t \text{ V}.$$

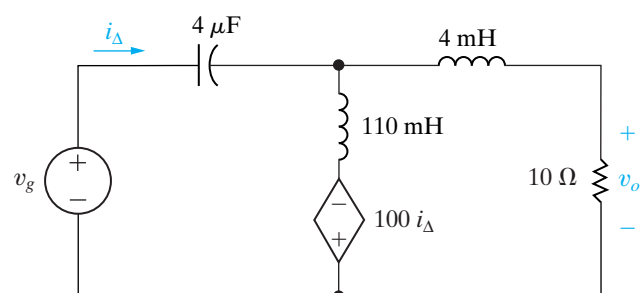
Figure P9.63



- 9.64** Use the mesh-current method to find the steady-state expression for  $v_o$  in the circuit seen in Fig. P9.64 if  $v_g$  equals  $75 \cos 5000t$  V.

PSPICE  
MULTISIM

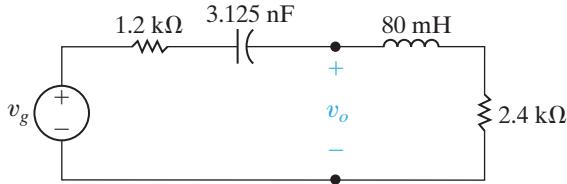
Figure P9.64



**Sections 9.5–9.9**

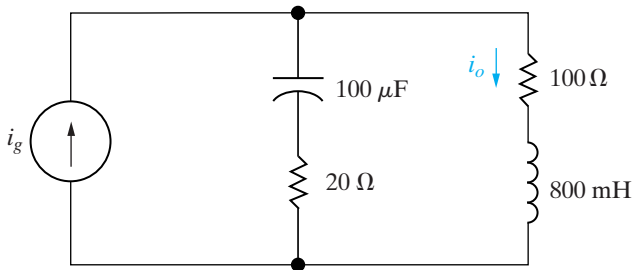
**9.65** Use the concept of voltage division to find the steady-state expression for  $v_o(t)$  in the circuit in Fig. P9.65 if  $v_g = 120 \cos 100,000t$  V.

**Figure P9.65**



**9.66** Use the concept of current division to find the steady-state expression for  $i_o$  in the circuit in Fig. P9.66 if  $i_g = 60 \cos 250t$  mA.

**Figure P9.66**



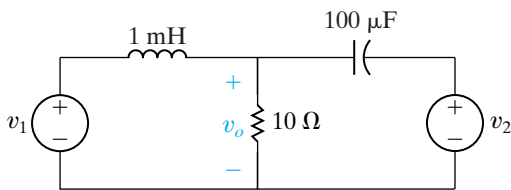
**9.67** For the circuit in Fig. P9.67. Suppose

$$v_1 = 20 \cos(2000t - 36.87^\circ) \text{ V}$$

$$v_2 = 10 \cos(5000t + 16.26^\circ) \text{ V}$$

- What circuit analysis technique must be used to find the steady-state expression for  $v_o(t)$ ?
- Find the steady-state expression for  $v_o(t)$ .

**Figure P9.67**



**9.68** For the circuit in Fig. P9.63, suppose

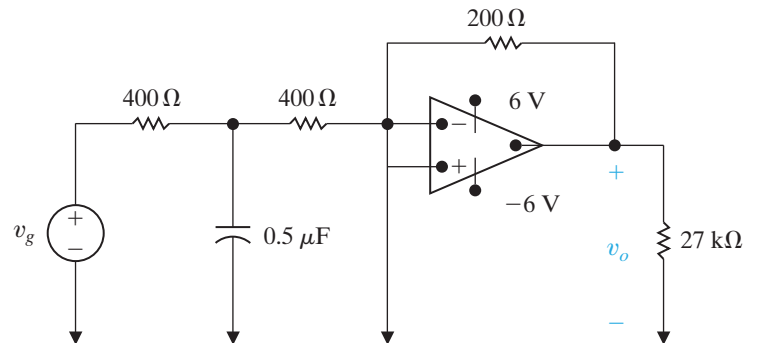
$$v_a = 10 \cos 16,000t \text{ V}$$

$$v_b = 20 \cos 4000t \text{ V.}$$

- What circuit analysis technique must be used to find the steady-state expression for  $i_o(t)$ ?
- Find the steady-state expression for  $i_o(t)$ .

**9.69** The sinusoidal voltage source in the circuit shown in Fig. P9.69 is generating the voltage  $v_g = 20 \cos 5000t$  V. If the op amp is ideal, what is the steady-state expression for  $v_o(t)$ ?

**Figure P9.69**



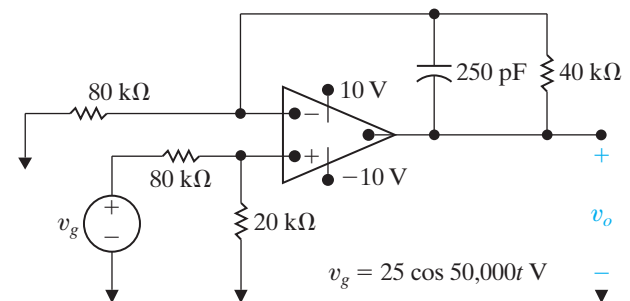
**9.70** The  $0.5 \mu\text{F}$  capacitor in the circuit seen in Fig. P9.69 is replaced with a variable capacitor. The capacitor is adjusted until the output voltage leads the input voltage by  $135^\circ$ .

- Find the value of  $C$  in microfarads.
- Write the steady-state expression for  $v_o(t)$  when  $C$  has the value found in (a).

**9.71** The op amp in the circuit in Fig. P9.71 is ideal.

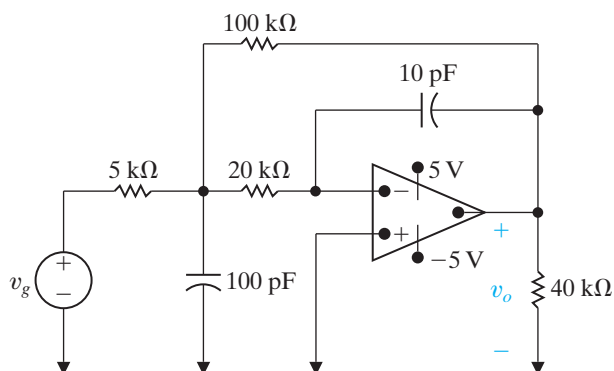
- Find the steady-state expression for  $v_o(t)$ .
- How large can the amplitude of  $v_g$  be before the amplifier saturates?

**Figure P9.71**



**9.72** The op amp in the circuit seen in Fig. P9.72 is ideal. Find the steady-state expression for  $v_o(t)$  when  $v_g = 2 \cos 10^6t$  V.

Figure P9.72

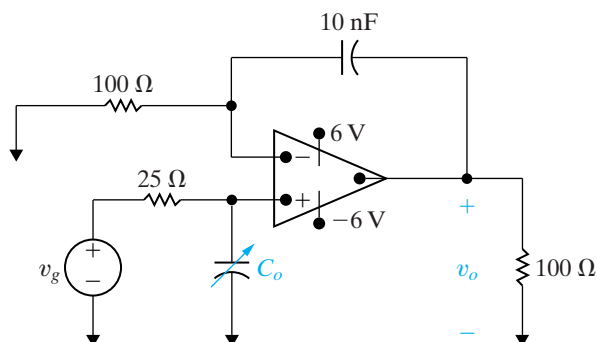


**9.73** The operational amplifier in the circuit shown in Fig. P9.73 is ideal. The voltage of the ideal sinusoidal source is  $v_g = 30 \cos 10^6 t$  V.

PSPICE  
MULTISIM

- How small can  $C_o$  be before the steady-state output voltage no longer has a pure sinusoidal waveform?
- For the value of  $C_o$  found in (a), write the steady-state expression for  $v_o$ .

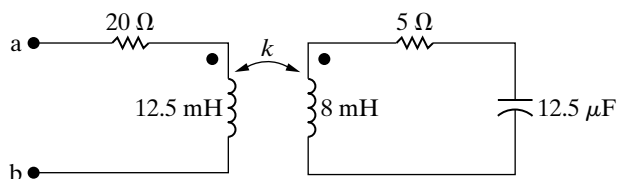
Figure P9.73



### Section 9.10

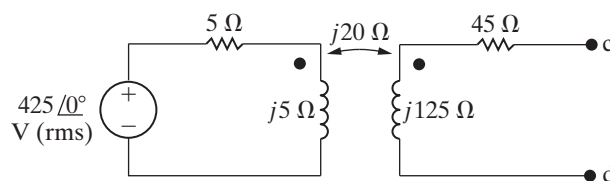
**9.74** The value of  $k$  in the circuit in Fig. P9.74 is adjusted so that  $Z_{ab}$  is purely resistive when  $\omega = 4$  krad/s. Find  $Z_{ab}$ .

Figure P9.74



**9.75** For the circuit in Fig. P9.75, find the Thévenin equivalent with respect to the terminals c,d.

Figure P9.75

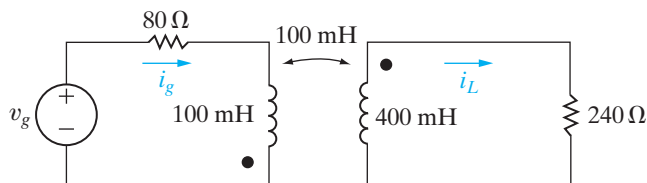


**9.76** a) Find the steady-state expressions for the currents  $i_g$  and  $i_L$  in the circuit in Fig. P9.76 when  $v_g = 168 \cos 800t$  V.

PSPICE  
MULTISIM

- Find the coefficient of coupling.
- Find the energy stored in the magnetically coupled coils at  $t = 625\pi \mu\text{s}$  and  $t = 1250\pi \mu\text{s}$ .

Figure P9.76

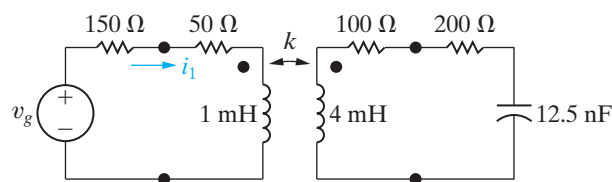


**9.77** The sinusoidal voltage source in the circuit seen in Fig. P9.77 is operating at a frequency of 200 krad/s. The coefficient of coupling is adjusted until the peak amplitude of  $i_1$  is maximum.

PSPICE  
MULTISIM

- What is the value of  $k$ ?
- What is the peak amplitude of  $i_1$  if  $v_g = 560 \cos(2 \times 10^5 t)$  V?

Figure P9.77



**9.78** A series combination of a 60 Ω resistor and a 50 mH inductor is connected to a sinusoidal voltage source by a linear transformer. The source is operating at a frequency of 400 rad/s. At this frequency, the internal impedance of the source is  $(10 + j12.75) \Omega$ . The rms voltage at the terminals of the source is 75 V when it is not loaded. The parameters of the linear transformer are  $R_1 = 8.34 \Omega$ ,  $L_1 = 90$  mH,  $R_2 = 100 \Omega$ ,  $L_2 = 250$  mH, and  $M = 135$  mH.

- What is the value of the impedance reflected into the primary?
- What is the value of the impedance seen from the terminals of the practical source?

**Section 9.11**

**9.79** At first glance, it may appear from Eq. 9.69 that an inductive load could make the reactance seen looking into the primary terminals (i.e.,  $X_{ab}$ ) look capacitive. Intuitively, we know this is impossible. Show that  $X_{ab}$  can never be negative if  $X_L$  is an inductive reactance.

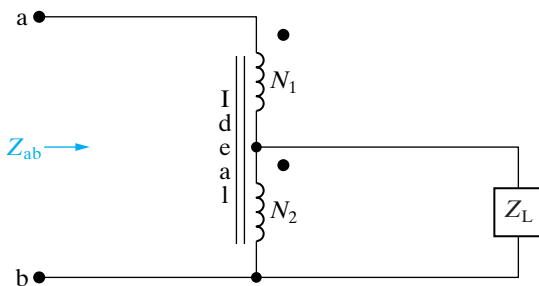
**9.80** a) Show that the impedance seen looking into the terminals a,b in the circuit in Fig. P9.80 is given by the expression

$$Z_{ab} = \left(1 + \frac{N_1}{N_2}\right)^2 Z_L.$$

b) Show that if the polarity terminals of either one of the coils is reversed,

$$Z_{ab} = \left(1 - \frac{N_1}{N_2}\right)^2 Z_L.$$

**Figure P9.80**



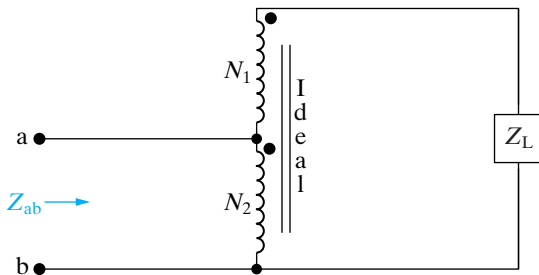
**9.81** a) Show that the impedance seen looking into the terminals a,b in the circuit in Fig. P9.81 is given by the expression

$$Z_{ab} = \frac{Z_L}{\left(1 + \frac{N_1}{N_2}\right)^2}.$$

b) Show that if the polarity terminal of either one of the coils is reversed that

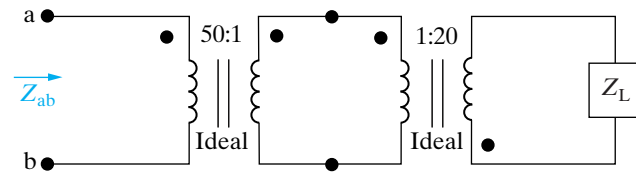
$$Z_{ab} = \frac{Z_L}{\left(1 - \frac{N_1}{N_2}\right)^2}.$$

**Figure P9.81**



**9.82** Find the impedance  $Z_{ab}$  in the circuit in Fig. P9.82 if  $Z_L = 200 \angle -45^\circ \Omega$ .

**Figure P9.82**

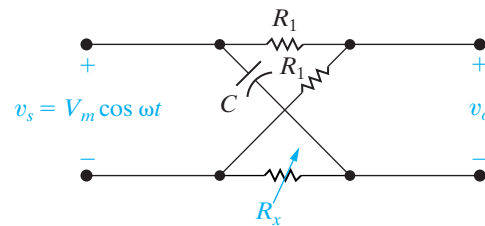


**Section 9.12**

**9.83** Show by using a phasor diagram what happens to the magnitude and phase angle of the voltage  $v_o$  in the circuit in Fig. P9.83 as  $R_x$  is varied from zero to infinity. The amplitude and phase angle of the source voltage are held constant as  $R_x$  varies.

PSPICE  
MULTISIM

**Figure P9.83**



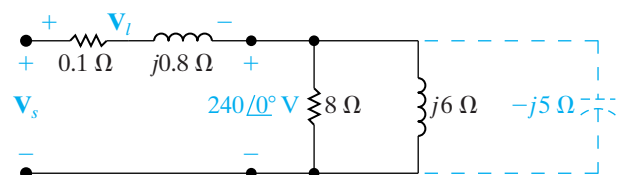
**9.84** The parameters in the circuit shown in Fig. 9.53 are  $R_1 = 0.1 \Omega$ ,  $\omega L_1 = 0.8 \Omega$ ,  $R_2 = 24 \Omega$ ,  $\omega L_2 = 32 \Omega$ , and  $\mathbf{V}_L = 240 + j0 \text{ V}$ .

- Calculate the phasor voltage  $\mathbf{V}_s$ .
- Connect a capacitor in parallel with the inductor, hold  $\mathbf{V}_L$  constant, and adjust the capacitor until the magnitude of  $\mathbf{I}$  is a minimum. What is the capacitive reactance? What is the value of  $\mathbf{V}_s$ ?
- Find the value of the capacitive reactance that keeps the magnitude of  $\mathbf{I}$  as small as possible and that at the same time makes

$$|\mathbf{V}_s| = |\mathbf{V}_L| = 240 \text{ V}.$$

- 9.85** a) For the circuit shown in Fig. P9.85, compute  $\mathbf{V}_s$  and  $\mathbf{V}_t$ .
- b) Construct a phasor diagram showing the relationship between  $\mathbf{V}_s$ ,  $\mathbf{V}_t$ , and the load voltage of  $240 \angle 0^\circ \text{ V}$ .
- c) Repeat parts (a) and (b), given that the load voltage remains constant at  $240 \angle 0^\circ \text{ V}$ , when a capacitive reactance of  $-5 \Omega$  is connected across the load terminals.

**Figure P9.85**

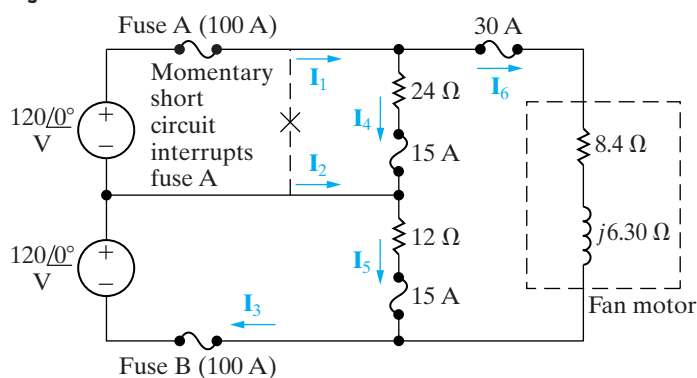


## Sections 9.1–9.12

**9.86** You may have the opportunity as an engineering graduate to serve as an expert witness in lawsuits involving either personal injury or property damage. As an example of the type of problem on which you may be asked to give an opinion, consider the following event. At the end of a day of fieldwork, a farmer returns to his farmstead, checks his hog confinement building, and finds to his dismay that the hogs are dead. The problem is traced to a blown fuse that caused a 240 V fan motor to stop. The loss of ventilation led to the suffocation of the livestock. The interrupted fuse is located in the main switch that connects the farmstead to the electrical service. Before the insurance company settles the claim, it wants to know if the electric circuit supplying the farmstead functioned properly. The lawyers for the insurance company are puzzled because the farmer's wife, who was in the house on the day of the accident convalescing from minor surgery, was able to watch TV during the afternoon. Furthermore, when she went to the kitchen to start preparing the evening meal, the electric clock indicated the correct time. The lawyers have hired you to explain (1) why the electric clock in the kitchen and the television set in the living room continued to operate after the fuse in the main switch blew and (2) why the second fuse in the main switch didn't blow after the fan motor stalled. After ascertaining the loads on the three-wire distribution circuit prior to the interruption of fuse A, you are able to construct the circuit model shown in Fig. P9.86. The impedances of the line conductors and the neutral conductor are assumed negligible.

- Calculate the branch currents  $\mathbf{I}_1$ ,  $\mathbf{I}_2$ ,  $\mathbf{I}_3$ ,  $\mathbf{I}_4$ ,  $\mathbf{I}_5$ , and  $\mathbf{I}_6$  prior to the interruption of fuse A.
- Calculate the branch currents after the interruption of fuse A. Assume the stalled fan motor behaves as a short circuit.
- Explain why the clock and television set were not affected by the momentary short circuit that interrupted fuse A.
- Assume the fan motor is equipped with a thermal cutout designed to interrupt the motor

Figure P9.86



circuit if the motor current becomes excessive. Would you expect the thermal cutout to operate? Explain.

- Explain why fuse B is not interrupted when the fan motor stalls.

**9.87** a) Calculate the branch currents  $\mathbf{I}_1$ – $\mathbf{I}_6$  in the circuit in Fig. 9.58.

PRACTICAL PERSPECTIVE

- Find the primary current  $\mathbf{I}_p$ .

**9.88** Suppose the 40 Ω resistance in the distribution circuit in Fig. 9.58 is replaced by a 20 Ω resistance.

PRACTICAL PERSPECTIVE

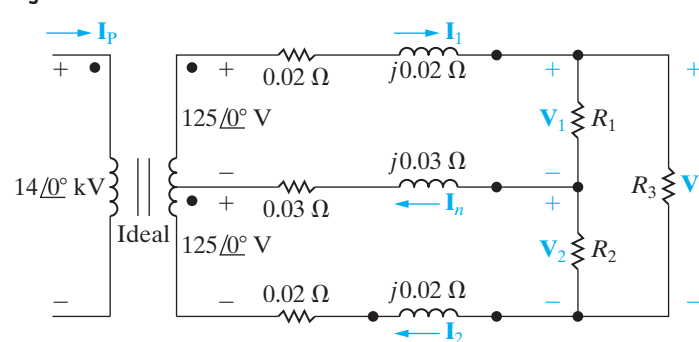
- Recalculate the branch current in the 2 Ω resistor,  $\mathbf{I}_2$ .
- Recalculate the primary current,  $\mathbf{I}_p$ .
- On the basis of your answers, is it desirable to have the resistance of the two 120 V loads be equal?

**9.89** A residential wiring circuit is shown in Fig. P9.89. In this model, the resistor  $R_3$  is used to model a 250 V appliance (such as an electric range), and the resistors  $R_1$  and  $R_2$  are used to model 125 V appliances (such as a lamp, toaster, and iron). The branches carrying  $\mathbf{I}_1$  and  $\mathbf{I}_2$  are modeling what electricians refer to as the hot conductors in the circuit, and the branch carrying  $\mathbf{I}_n$  is modeling the neutral conductor. Our purpose in analyzing the circuit is to show the importance of the neutral conductor in the satisfactory operation of the circuit. You are to choose the method for analyzing the circuit.

PRACTICAL PERSPECTIVE

- Show that  $\mathbf{I}_n$  is zero if  $R_1 = R_2$ .
- Show that  $\mathbf{V}_1 = \mathbf{V}_2$  if  $R_1 = R_2$ .
- Open the neutral branch and calculate  $\mathbf{V}_1$  and  $\mathbf{V}_2$  if  $R_1 = 40 \Omega$ ,  $R_2 = 400 \Omega$ , and  $R_3 = 8 \Omega$ .
- Close the neutral branch and repeat (c).
- On the basis of your calculations, explain why the neutral conductor is never fused in such a manner that it could open while the hot conductors are energized.

Figure P9.89



**9.90** a) Find the primary current  $\mathbf{I}_p$  for (c) and (d) in Problem 9.89.

PRACTICAL PERSPECTIVE

- Do your answers make sense in terms of known circuit behavior?



# CHAPTER 10

## CHAPTER CONTENTS

- 10.1 **Instantaneous Power** *p. 360*
- 10.2 **Average and Reactive Power** *p. 361*
- 10.3 **The rms Value and Power Calculations** *p. 366*
- 10.4 **Complex Power** *p. 368*
- 10.5 **Power Calculations** *p. 369*
- 10.6 **Maximum Power Transfer** *p. 376*

## ✓ CHAPTER OBJECTIVES

- 1 Understand the following ac power concepts, their relationships to one another, and how to calculate them in a circuit:
  - Instantaneous power;
  - Average (real) power;
  - Reactive power;
  - Complex power; and
  - Power factor.
- 2 Understand the condition for maximum real power delivered to a load in an ac circuit and be able to calculate the load impedance required to deliver maximum real power to the load.
- 3 Be able to calculate all forms of ac power in ac circuits with linear transformers and in ac circuits with ideal transformers.

# Sinusoidal Steady-State Power Calculations

**Power engineering has evolved** into one of the important sub-disciplines within electrical engineering. The range of problems dealing with the delivery of energy to do work is considerable, from determining the power rating within which an appliance operates safely and efficiently, to designing the vast array of generators, transformers, and wires that provide electric energy to household and industrial consumers.

Nearly all electric energy is supplied in the form of sinusoidal voltages and currents. Thus, after our Chapter 9 discussion of sinusoidal circuits, this is the logical place to consider sinusoidal steady-state power calculations. We are primarily interested in the average power delivered to or supplied from a pair of terminals as a result of sinusoidal voltages and currents. Other measures, such as reactive power, complex power, and apparent power, will also be presented. The concept of the rms value of a sinusoid, briefly introduced in Chapter 9, is particularly pertinent to power calculations.

We begin and end this chapter with two concepts that should be very familiar to you from previous chapters: the basic equation for power (Section 10.1) and maximum power transfer (Section 10.6). In between, we discuss the general processes for analyzing power, which will be familiar from your studies in Chapters 1 and 4, although some additional mathematical techniques are required here to deal with sinusoidal, rather than dc, signals.



## Practical Perspective

### Vampire Power

In Chapter 9 we calculated the steady-state voltages and currents in electric circuits driven by sinusoidal sources. In this chapter we consider power in these circuits. The techniques we develop are useful for analyzing many of the electrical devices we encounter daily, because sinusoidal sources are the predominant means of providing electric power.

Even when we are not using many of the common electrical devices found in our homes, schools, and businesses, they may still be consuming power. This “standby power” may be used to run an internal clock, charge batteries, display time or other quantities, monitor temperature or other environmental measures, or search for signals to receive. Devices such as microwave ovens, DVRs, televisions, remote controls, and computers all consume power when not in use.

The ac adapters used to charge many portable devices are a common source of standby power. Even when the device is unplugged from the adapter, the adapter may continue to consume power if it is plugged into the wall outlet. The plug on the adapter looks like vampire fangs, so this standby power became known as “vampire power.” It is power that is used even while we sleep.

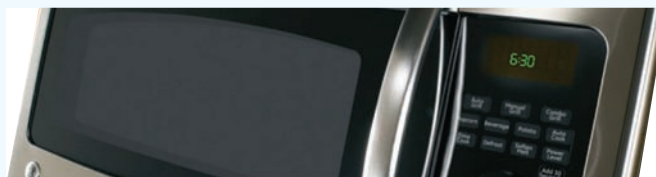
How much vampire power is used by the electrical devices in our home over the course of a year? Is there a way to reduce or eliminate vampire power? These questions will be explored in the Practical Perspective example at the end of the chapter, and in the chapter problems.



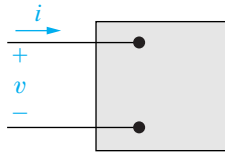
borissos / fotolia



katalinks / fotolia



magraphics.eu / fotolia



**Figure 10.1** ▲ The black box representation of a circuit used for calculating power.

## 10.1 Instantaneous Power

We begin our investigation of sinusoidal power calculations with the familiar circuit in Fig. 10.1. Here,  $v$  and  $i$  are steady-state sinusoidal signals. Using the passive sign convention, the power at any instant of time is

$$p = vi. \quad (10.1)$$

This is **instantaneous power**. Remember that if the reference direction of the current is in the direction of the voltage rise, Eq. 10.1 must be written with a minus sign. Instantaneous power is measured in watts when the voltage is in volts and the current is in amperes. First, we write expressions for  $v$  and  $i$ :

$$v = V_m \cos(\omega t + \theta_v), \quad (10.2)$$

$$i = I_m \cos(\omega t + \theta_i), \quad (10.3)$$

where  $\theta_v$  is the voltage phase angle, and  $\theta_i$  is the current phase angle.

We are operating in the sinusoidal steady state, so we may choose any convenient reference for zero time. Engineers designing systems that transfer large blocks of power have found it convenient to use a zero time corresponding to the instant the current is passing through a positive maximum. This reference system requires a shift of both the voltage and current by  $\theta_i$ . Thus Eqs. 10.2 and 10.3 become

$$v = V_m \cos(\omega t + \theta_v - \theta_i), \quad (10.4)$$

$$i = I_m \cos \omega t. \quad (10.5)$$

When we substitute Eqs. 10.4 and 10.5 into Eq. 10.1, the expression for the instantaneous power becomes

$$p = V_m I_m \cos(\omega t + \theta_v - \theta_i) \cos \omega t. \quad (10.6)$$

We could use Eq. 10.6 directly to find the average power; however, by simply applying a couple of trigonometric identities, we can put Eq. 10.6 into a much more informative form.

We begin with the trigonometric identity<sup>1</sup>

$$\cos \alpha \cos \beta = \frac{1}{2} \cos(\alpha - \beta) + \frac{1}{2} \cos(\alpha + \beta)$$

to expand Eq. 10.6; letting  $\alpha = \omega t + \theta_v - \theta_i$  and  $\beta = \omega t$  gives

$$p = \frac{V_m I_m}{2} \cos(\theta_v - \theta_i) + \frac{V_m I_m}{2} \cos(2\omega t + \theta_v - \theta_i). \quad (10.7)$$

Now use the trigonometric identity

$$\cos(\alpha + \beta) = \cos \alpha \cos \beta - \sin \alpha \sin \beta$$

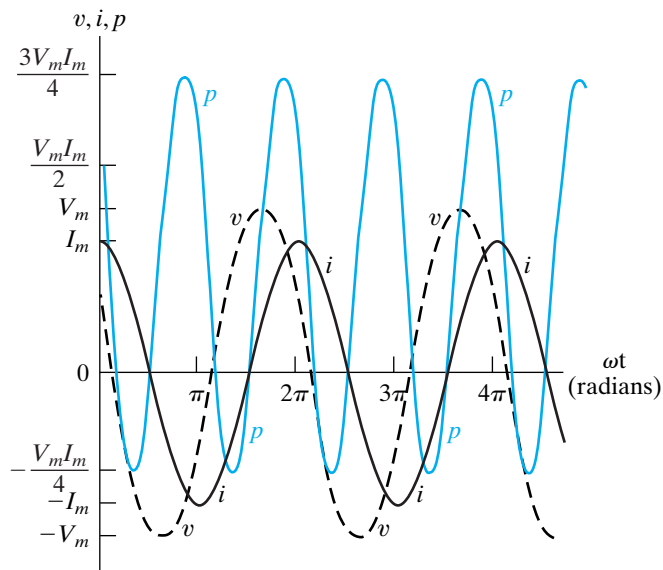
<sup>1</sup> See entry 8 in Appendix F.

to expand the second term on the right-hand side of Eq. 10.7, which gives

$$p = \frac{V_m I_m}{2} \cos(\theta_v - \theta_i) + \frac{V_m I_m}{2} \cos(\theta_v - \theta_i) \cos 2\omega t - \frac{V_m I_m}{2} \sin(\theta_v - \theta_i) \sin 2\omega t. \quad (10.8)$$

Figure 10.2 depicts a representative relationship among  $v$ ,  $i$ , and  $p$ , based on the assumptions  $\theta_v = 60^\circ$  and  $\theta_i = 0^\circ$ . You can see that the frequency of the instantaneous power is twice the frequency of the voltage or current. This observation also follows directly from the second two terms on the right-hand side of Eq. 10.8. Therefore, the instantaneous power goes through two complete cycles for every cycle of either the voltage or the current. Also note that the instantaneous power may be negative for a portion of each cycle, even if the network between the terminals is passive. In a completely passive network, negative power implies that energy stored in the inductors or capacitors is now being extracted. The fact that the instantaneous power varies with time in the sinusoidal steady-state operation of a circuit explains why some motor-driven appliances (such as refrigerators) experience vibration and require resilient motor mountings to prevent excessive vibration.

We are now ready to use Eq. 10.8 to find the average power at the terminals of the circuit represented by Fig. 10.1 and, at the same time, introduce the concept of reactive power.



**Figure 10.2** ▲ Instantaneous power, voltage, and current versus  $\omega t$  for steady-state sinusoidal operation.

## 10.2 Average and Reactive Power

We begin by noting that Eq. 10.8 has three terms, which we can rewrite as follows:

$$p = P + P \cos 2\omega t - Q \sin 2\omega t, \quad (10.9)$$

where

**Average (real) power** ►

$$P = \frac{V_m I_m}{2} \cos(\theta_v - \theta_i), \quad (10.10)$$

**Reactive power** ►

$$Q = \frac{V_m I_m}{2} \sin(\theta_v - \theta_i). \quad (10.11)$$

$P$  is called the **average power**, and  $Q$  is called the **reactive power**. Average power is sometimes called **real power**, because it describes the power in a circuit that is transformed from electric to nonelectric energy. Although the two terms are interchangeable, we primarily use the term *average power* in this text.

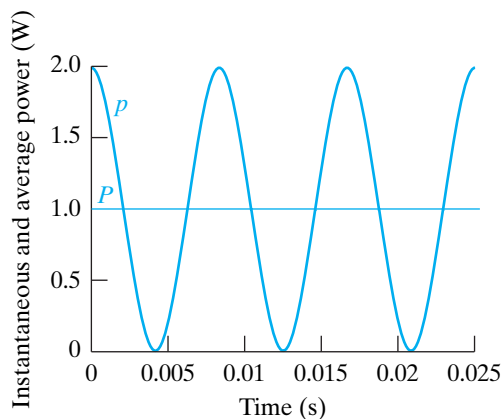
It is easy to see why  $P$  is called the average power. The average power associated with sinusoidal signals is the average of the instantaneous power over one period, or, in equation form,

$$P = \frac{1}{T} \int_{t_0}^{t_0+T} p \, dt, \quad (10.12)$$

where  $T$  is the period of the sinusoidal function. The limits on Eq. 10.12 imply that we can initiate the integration process at any convenient time  $t_0$  but that we must terminate the integration exactly one period later. (We could integrate over  $nT$  periods, where  $n$  is an integer, provided we multiply the integral by  $1/nT$ .)

We could find the average power by substituting Eq. 10.9 directly into Eq. 10.12 and then performing the integration. But note that the average value of  $p$  is given by the first term on the right-hand side of Eq. 10.9, because the integral of both  $\cos 2\omega t$  and  $\sin 2\omega t$  over one period is zero. Thus the average power is given in Eq. 10.10.

We can develop a better understanding of all the terms in Eq. 10.9 and the relationships among them by examining the power in circuits that are purely resistive, purely inductive, or purely capacitive.



**Figure 10.3** ▲ Instantaneous real power and average power for a purely resistive circuit.

### Power for Purely Resistive Circuits

If the circuit between the terminals is purely resistive, the voltage and current are in phase, which means that  $\theta_v = \theta_i$ . Equation 10.9 then reduces to

$$p = P + P \cos 2\omega t. \quad (10.13)$$

The instantaneous power expressed in Eq. 10.13 is referred to as the **instantaneous real power**. Figure 10.3 shows a graph of Eq. 10.13 for a representative purely resistive circuit, assuming  $\omega = 377$  rad/s. By definition, the average power,  $P$ , is the average of  $p$  over one period. Thus it is easy to see just by looking at the graph that  $P = 1$  for this circuit. Note from Eq. 10.13 that the instantaneous real power can never be negative, which is also shown in Fig. 10.3. In other words, power cannot be extracted from a purely resistive network. Rather, all the electric energy is dissipated in the form of thermal energy.

### Power for Purely Inductive Circuits

If the circuit between the terminals is purely inductive, the voltage and current are out of phase by precisely  $90^\circ$ . In particular, the current lags the voltage by  $90^\circ$  (that is,  $\theta_i = \theta_v - 90^\circ$ ); therefore  $\theta_v - \theta_i = +90^\circ$ . The expression for the instantaneous power then reduces to

$$p = -Q \sin 2\omega t. \quad (10.14)$$

In a purely inductive circuit, the average power is zero. Therefore no transformation of energy from electric to nonelectric form takes place. The instantaneous power at the terminals in a purely inductive circuit is continually exchanged between the circuit and the source driving the circuit, at a frequency of  $2\omega$ . In other words, when  $p$  is positive, energy is being stored in the magnetic fields associated with the inductive elements, and when  $p$  is negative, energy is being extracted from the magnetic fields.

A measure of the power associated with purely inductive circuits is the reactive power  $Q$ . The name *reactive power* comes from the characterization of an inductor as a reactive element; its impedance is purely reactive. Note that average power  $P$  and reactive power  $Q$  carry the same dimension. To distinguish between average and reactive power, we use the units *watt* (W) for average power and **var** (*volt-amp reactive*, or VAR) for reactive power. Figure 10.4 plots the instantaneous power for a representative purely inductive circuit, assuming  $\omega = 377$  rad/s and  $Q = 1$  VAR.

### Power for Purely Capacitive Circuits

If the circuit between the terminals is purely capacitive, the voltage and current are precisely  $90^\circ$  out of phase. In this case, the current leads the voltage by  $90^\circ$  (that is,  $\theta_i = \theta_v + 90^\circ$ ); thus,  $\theta_v - \theta_i = -90^\circ$ . The expression for the instantaneous power then becomes

$$p = -Q \sin 2\omega t. \quad (10.15)$$

Again, the average power is zero, so there is no transformation of energy from electric to nonelectric form. In a purely capacitive circuit, the power is continually exchanged between the source driving the circuit and the electric field associated with the capacitive elements. Figure 10.5 plots the instantaneous power for a representative purely capacitive circuit, assuming  $\omega = 377$  rad/s and  $Q = -1$  VAR.

Note that the decision to use the current as the reference leads to  $Q$  being positive for inductors (that is,  $\theta_v - \theta_i = 90^\circ$  and negative for capacitors (that is,  $\theta_v - \theta_i = -90^\circ$ ). Power engineers recognize this difference in the algebraic sign of  $Q$  by saying that inductors demand (or absorb) magnetizing vars, and capacitors furnish (or deliver) magnetizing vars. We say more about this convention later.

### The Power Factor

The angle  $\theta_v - \theta_i$  plays a role in the computation of both average and reactive power and is referred to as the **power factor angle**. The cosine of this angle is called the **power factor**, abbreviated pf, and the sine of this angle is called the **reactive factor**, abbreviated rf. Thus

$$\text{pf} = \cos(\theta_v - \theta_i), \quad (10.16)$$

$$\text{rf} = \sin(\theta_v - \theta_i). \quad (10.17)$$

Knowing the value of the power factor does not tell you the value of the power factor angle, because  $\cos(\theta_v - \theta_i) = \cos(\theta_i - \theta_v)$ . To completely describe this angle, we use the descriptive phrases **lagging power factor** and **leading power factor**. Lagging power factor implies that current lags voltage—hence an inductive load. Leading power factor implies that current leads voltage—hence a capacitive load. Both the power factor and the reactive factor are convenient quantities to use in describing electrical loads.

Example 10.1 illustrates the interpretation of  $P$  and  $Q$  on the basis of a numerical calculation.

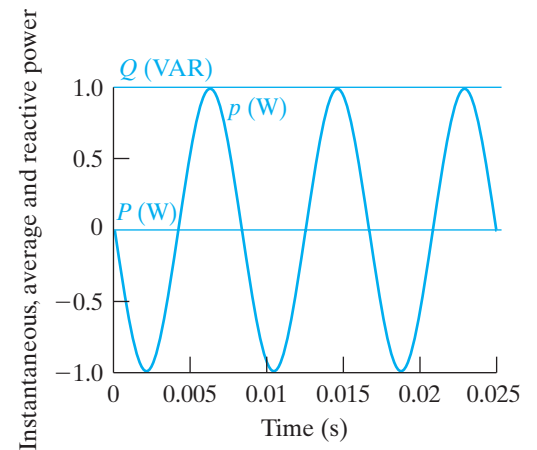


Figure 10.4 ▲ Instantaneous real power, average power, and reactive power for a purely inductive circuit.

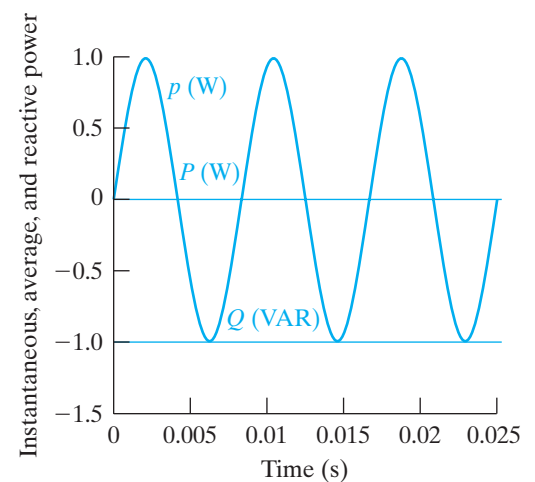


Figure 10.5 ▲ Instantaneous real power and average power for a purely capacitive circuit.

#### ◀ Power factor

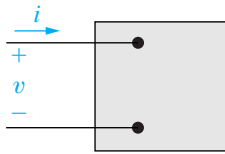
**Example 10.1** Calculating Average and Reactive Power

- a) Calculate the average power and the reactive power at the terminals of the network shown in Fig. 10.6 if

$$v = 100 \cos(\omega t + 15^\circ) \text{ V},$$

$$i = 4 \sin(\omega t - 15^\circ) \text{ A}.$$

- b) State whether the network inside the box is absorbing or delivering average power.  
c) State whether the network inside the box is absorbing or supplying magnetizing vars.



**Figure 10.6** ▲ A pair of terminals used for calculating power.

**Solution**

- a) Because  $i$  is expressed in terms of the sine function, the first step in the calculation for  $P$  and  $Q$  is to rewrite  $i$  as a cosine function:

$$i = 4 \cos(\omega t - 105^\circ) \text{ A}.$$

We now calculate  $P$  and  $Q$  directly from Eqs. 10.10 and 10.11. Thus

$$P = \frac{1}{2}(100)(4) \cos[15 - (-105)] = -100 \text{ W},$$

$$Q = \frac{1}{2}100(4) \sin[15 - (-105)] = 173.21 \text{ VAR}.$$

- b) Note from Fig. 10.6 the use of the passive sign convention. Because of this, the negative value of  $-100 \text{ W}$  means that the network inside the box is delivering average power to the terminals.  
c) The passive sign convention means that, because  $Q$  is positive, the network inside the box is absorbing magnetizing vars at its terminals.

**ASSESSMENT PROBLEMS****Objective 1—Understand ac power concepts, their relationships to one another, and how to calculate them in a circuit**

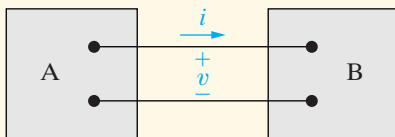
**10.1** For each of the following sets of voltage and current, calculate the real and reactive power in the line between networks A and B in the circuit shown. In each case, state whether the power flow is from A to B or vice versa. Also state whether magnetizing vars are being transferred from A to B or vice versa.

a)  $v = 100 \cos(\omega t - 45^\circ) \text{ V};$   
 $i = 20 \cos(\omega t + 15^\circ) \text{ A}.$

b)  $v = 100 \cos(\omega t - 45^\circ) \text{ V};$   
 $i = 20 \cos(\omega t + 165^\circ) \text{ A}.$

c)  $v = 100 \cos(\omega t - 45^\circ) \text{ V};$   
 $i = 20 \cos(\omega t - 105^\circ) \text{ A}.$

d)  $v = 100 \cos \omega t \text{ V};$   
 $i = 20 \cos(\omega t + 120^\circ) \text{ A}.$



**NOTE:** Also try Chapter Problem 10.1.

**Answer:** (a)  $P = 500 \text{ W}$  (A to B),  
 $Q = -866.03 \text{ VAR}$  (B to A);

(b)  $P = -866.03 \text{ W}$  (B to A),  
 $Q = 500 \text{ VAR}$  (A to B);

(c)  $P = 500 \text{ W}$  (A to B),  
 $Q = 866.03 \text{ VAR}$  (A to B);

(d)  $P = -500 \text{ W}$  (B to A),  
 $Q = -866.03 \text{ VAR}$  (B to A).

**10.2** Compute the power factor and the reactive factor for the network inside the box in Fig. 10.6, whose voltage and current are described in Example 10.1.

Hint: Use  $-i$  to calculate the power and reactive factors.

**Answer:** pf = 0.5 leading; rf =  $-0.866$ .



## Appliance Ratings

Average power is used to quantify the power needs of household appliances. The average power rating and estimated annual kilowatt-hour consumption of some common appliances are presented in Table 10.1. The energy consumption values are obtained by estimating the number of hours annually that the appliances are in use. For example, a coffeemaker has an estimated annual consumption of 140 kWh and an average power consumption during operation of 1.2 kW. Therefore a coffeemaker is assumed to be in operation  $140/1.2$ , or 116.67, hours per year, or approximately 19 minutes per day.

Example 10.2 uses Table 10.1 to determine whether four common appliances can all be in operation without exceeding the current-carrying capacity of the household.

### Example 10.2 Making Power Calculations Involving Household Appliances

The branch circuit supplying the outlets in a typical home kitchen is wired with #12 conductor and is protected by either a 20 A fuse or a 20 A circuit breaker. Assume that the following 120 V appliances are in operation at the same time: a coffeemaker, egg cooker, frying pan, and toaster. Will the circuit be interrupted by the protective device?

### Solution

From Table 10.1, the total average power demanded by the four appliances is

$$P = 1200 + 516 + 1196 + 1146 = 4058 \text{ W.}$$

The total current in the protective device is

$$I_{\text{eff}} = \frac{4058}{120} \approx 33.82 \text{ A.}$$

Yes, the protective device will interrupt the circuit.

**TABLE 10.1 Annual Energy Requirements of Electric Household Appliances**

Appliance	Average Wattage	Est. kWh Consumed Annually <sup>a</sup>	Appliance	Average Wattage	Est. kWh Consumed Annually <sup>a</sup>
<b>Food preparation</b>			<b>Health and beauty</b>		
Coffeemaker	1200	140	Hair dryer	600	25
Dishwasher	1201	165	Shaver	15	0.5
Egg cooker	516	14	Sunlamp	279	16
Frying pan	1196	100	<b>Home entertainment</b>		
Mixer	127	2	Radio	71	86
Oven, microwave (only)	1450	190	Television, color, tube type	240	528
Range, with oven	12,200	596	Solid-state type	145	320
Toaster	1146	39	<b>Housewares</b>		
<b>Laundry</b>			Clock	2	17
Clothes dryer	4856	993	Vacuum cleaner	630	46
Washing machine, automatic	512	103			
Water heater	2475	4219			
Quick recovery type	4474	4811			
<b>Comfort conditioning</b>					
Air conditioner (room)	860	860 <sup>b</sup>			
Dehumidifier	257	377			
Fan (circulating)	88	43			
Heater (portable)	1322	176			

a) Based on normal usage. When using these figures for projections, such factors as the size of the specific appliance, the geographical area of use, and individual usage should be taken into consideration. Note that the wattages are not additive, since all units are normally not in operation at the same time.

b) Based on 1000 hours of operation per year. This figure will vary widely depending on the area and the specific size of the unit. See EEI-Pub #76-2, "Air Conditioning Usage Study," for an estimate for your location.

Source: Edison Electric Institute.

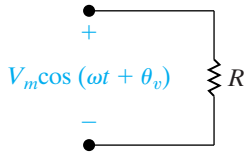
**NOTE:** Assess your understanding of this material by trying Chapter Problem 10.2.



## 10.3 The rms Value and Power Calculations

In introducing the rms value of a sinusoidal voltage (or current) in Section 9.1, we mentioned that it would play an important role in power calculations. We can now discuss this role.

Assume that a sinusoidal voltage is applied to the terminals of a resistor, as shown in Fig. 10.7, and that we want to determine the average power delivered to the resistor. From Eq. 10.12,



**Figure 10.7** ▲ A sinusoidal voltage applied to the terminals of a resistor.

$$P = \frac{1}{T} \int_{t_0}^{t_0+T} \frac{V_m^2 \cos^2(\omega t + \phi_v)}{R} dt$$

$$= \frac{1}{R} \left[ \frac{1}{T} \int_{t_0}^{t_0+T} V_m^2 \cos^2(\omega t + \phi_v) dt \right]. \quad (10.18)$$

Comparing Eq. 10.18 with Eq. 9.5 reveals that the average power delivered to  $R$  is simply the rms value of the voltage squared divided by  $R$ , or

$$P = \frac{V_{\text{rms}}^2}{R}. \quad (10.19)$$

If the resistor is carrying a sinusoidal current, say,  $I_m \cos(\omega t + \phi_i)$ , the average power delivered to the resistor is

$$P = I_{\text{rms}}^2 R. \quad (10.20)$$

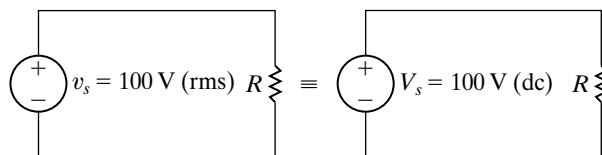
The rms value is also referred to as the **effective value** of the sinusoidal voltage (or current). The rms value has an interesting property: Given an equivalent resistive load,  $R$ , and an equivalent time period,  $T$ , the rms value of a sinusoidal source delivers the same energy to  $R$  as does a dc source of the same value. For example, a dc source of 100 V delivers the same energy in  $T$  seconds that a sinusoidal source of 100  $V_{\text{rms}}$  delivers, assuming equivalent load resistances (see Problem 10.12). Figure 10.8 demonstrates this equivalence. Energywise, the effect of the two sources is identical. This has led to the term *effective value* being used interchangeably with *rms value*.

The average power given by Eq. 10.10 and the reactive power given by Eq. 10.11 can be written in terms of effective values:

$$P = \frac{V_m I_m}{2} \cos(\theta_v - \theta_i)$$

$$= \frac{V_m}{\sqrt{2}} \frac{I_m}{\sqrt{2}} \cos(\theta_v - \theta_i)$$

$$= V_{\text{eff}} I_{\text{eff}} \cos(\theta_v - \theta_i); \quad (10.21)$$



**Figure 10.8** ▲ The effective value of  $v_s$  (100 V rms) delivers the same power to  $R$  as the dc voltage  $V_s$  (100 V dc).

and, by similar manipulation,

$$Q = V_{\text{eff}} I_{\text{eff}} \sin(\theta_v - \theta_i). \quad (10.22)$$

The effective value of the sinusoidal signal in power calculations is so widely used that voltage and current ratings of circuits and equipment involved in power utilization are given in terms of rms values. For example, the voltage rating of residential electric wiring is often 240 V/120 V service. These voltage levels are the rms values of the sinusoidal voltages supplied by the utility company, which provides power at two voltage levels to accommodate low-voltage appliances (such as televisions) and higher voltage appliances (such as electric ranges). Appliances such as electric lamps, irons, and toasters all carry rms ratings on their nameplates. For example, a 120 V, 100 W lamp has a resistance of  $120^2/100$ , or  $144 \Omega$ , and draws an rms current of  $120/144$ , or 0.833 A. The peak value of the lamp current is  $0.833\sqrt{2}$ , or 1.18 A.

The phasor transform of a sinusoidal function may also be expressed in terms of the rms value. The magnitude of the rms phasor is equal to the rms value of the sinusoidal function. If a phasor is based on the rms value, we indicate this by either an explicit statement, a parenthetical “rms” adjacent to the phasor quantity, or the subscript “eff,” as in Eq. 10.21.

In Example 10.3, we illustrate the use of rms values for calculating power.

### Example 10.3 Determining Average Power Delivered to a Resistor by Sinusoidal Voltage

- a) A sinusoidal voltage having a maximum amplitude of 625 V is applied to the terminals of a  $50 \Omega$  resistor. Find the average power delivered to the resistor.
- b) Repeat (a) by first finding the current in the resistor.

#### Solution

- a) The rms value of the sinusoidal voltage is  $625/\sqrt{2}$ , or approximately 441.94 V. From

Eq. 10.19, the average power delivered to the  $50 \Omega$  resistor is

$$P = \frac{(441.94)^2}{50} = 3906.25 \text{ W.}$$

- b) The maximum amplitude of the current in the resistor is  $625/50$ , or 12.5 A. The rms value of the current is  $12.5/\sqrt{2}$ , or approximately 8.84 A. Hence the average power delivered to the resistor is

$$P = (8.84)^2 50 = 3906.25 \text{ W.}$$

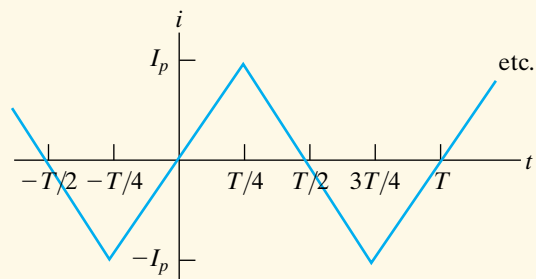
## ASSESSMENT PROBLEM

**Objective 1—Understand ac power concepts, their relationships to one another, and how to calculate them in a circuit**

- 10.3** The periodic triangular current in Example 9.4, repeated here, has a peak value of 180 mA. Find the average power that this current delivers to a  $5 \text{ k}\Omega$  resistor.

**Answer:** 54 W.

*NOTE:* Also try Chapter Problem 10.15.



## 10.4 Complex Power

Before proceeding to the various methods of calculating real and reactive power in circuits operating in the sinusoidal steady state, we need to introduce and define complex power. **Complex power** is the complex sum of real power and reactive power, or

$$\text{Complex power} \blacktriangleright \quad S = P + jQ. \quad (10.23)$$

As you will see, we can compute the complex power directly from the voltage and current phasors for a circuit. Equation 10.23 can then be used to compute the average power and the reactive power, because  $P = \Re\{S\}$  and  $Q = \Im\{S\}$ .

Dimensionally, complex power is the same as average or reactive power. However, to distinguish complex power from either average or reactive power, we use the units **volt-amps (VA)**. Thus we use volt-amps for complex power, watts for average power, and vars for reactive power, as summarized in Table 10.2.

Another advantage of using complex power is the geometric interpretation it provides. When working with Eq. 10.23, think of  $P$ ,  $Q$ , and  $|S|$  as the sides of a right triangle, as shown in Fig. 10.9. It is easy to show that the angle  $\theta$  in the power triangle is the power factor angle  $\theta_v - \theta_i$ . For the right triangle shown in Fig. 10.9,

$$\tan \theta = \frac{Q}{P}. \quad (10.24)$$

But from the definitions of  $P$  and  $Q$  (Eqs. [10.10] and [10.11], respectively),

$$\begin{aligned} \frac{Q}{P} &= \frac{(V_m I_m / 2) \sin(\theta_v - \theta_i)}{(V_m I_m / 2) \cos(\theta_v - \theta_i)} \\ &= \tan(\theta_v - \theta_i). \end{aligned} \quad (10.25)$$

Therefore,  $\theta = \theta_v - \theta_i$ . The geometric relations for a right triangle mean also that the four power triangle dimensions (the three sides and the power factor angle) can be determined if any two of the four are known.

The magnitude of complex power is referred to as **apparent power**. Specifically,

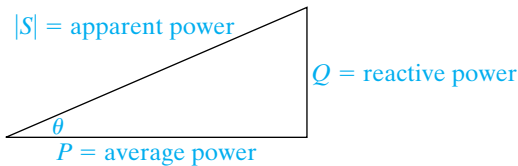
$$\text{Apparent power} \blacktriangleright \quad |S| = \sqrt{P^2 + Q^2}. \quad (10.26)$$

Apparent power, like complex power, is measured in volt-amps. The apparent power, or volt-amp, requirement of a device designed to convert electric energy to a nonelectric form is more important than the average power requirement. Although the average power represents the useful output of the energy-converting device, the apparent power represents the volt-amp capacity required to supply the average power. As you can see from the power triangle in Fig. 10.9, unless the power factor angle is  $0^\circ$  (that is, the device is purely resistive,  $\text{pf} = 1$ , and  $Q = 0$ ), the volt-amp capacity required by the device is larger than the average power used by the device. As we will see in Example 10.6, it makes sense to operate devices at a power factor close to 1.

Many useful appliances (such as refrigerators, fans, air conditioners, fluorescent lighting fixtures, and washing machines) and most industrial loads operate at a lagging power factor. The power factor of these loads sometimes is corrected either by adding a capacitor to the device itself or

**TABLE 10.2** Three Power Quantities and Their Units

Quantity	Units
Complex power	volt-amps
Average power	watts
Reactive power	var



**Figure 10.9** ▲ A power triangle.

by connecting capacitors across the line feeding the load; the latter method is often used for large industrial loads. Many of the Chapter Problems give you a chance to make some calculations that correct a lagging power factor load and improve the operation of a circuit.

Example 10.4 uses a power triangle to calculate several quantities associated with an electrical load.

### Example 10.4 Calculating Complex Power

An electrical load operates at 240 V rms. The load absorbs an average power of 8 kW at a lagging power factor of 0.8.

- Calculate the complex power of the load.
- Calculate the impedance of the load.

#### Solution

- The power factor is described as lagging, so we know that the load is inductive and that the algebraic sign of the reactive power is positive. From the power triangle shown in Fig. 10.10,

$$P = |S| \cos \theta,$$

$$Q = |S| \sin \theta.$$

Now, because  $\cos \theta = 0.8$ ,  $\sin \theta = 0.6$ .  
Therefore

$$|S| = \frac{P}{\cos \theta} = \frac{8 \text{ kW}}{0.8} = 10 \text{ kVA},$$

$$Q = 10 \sin \theta = 6 \text{ kVAR},$$

and

$$S = 8 + j6 \text{ kVA}.$$

- From the computation of the complex power of the load, we see that  $P = 8 \text{ kW}$ . Using Eq. 10.21,

$$P = V_{\text{eff}} I_{\text{eff}} \cos(\theta_v - \theta_i)$$

$$= (240) I_{\text{eff}} (0.8)$$

$$= 8000 \text{ W}.$$

Solving for  $I_{\text{eff}}$ ,

$$I_{\text{eff}} = 41.67 \text{ A}.$$

We already know the angle of the load impedance, because it is the power factor angle:

$$\theta = \cos^{-1}(0.8) = 36.87^\circ.$$

We also know that  $\theta$  is positive because the power factor is lagging, indicating an inductive load. We compute the magnitude of the load impedance from its definition as the ratio of the magnitude of the voltage to the magnitude of the current:

$$|Z| = \frac{|V_{\text{eff}}|}{|I_{\text{eff}}|} = \frac{240}{41.67} = 5.76.$$

Hence,

$$Z = 5.76 \angle 36.87^\circ \Omega = 4.608 + j3.456 \Omega.$$

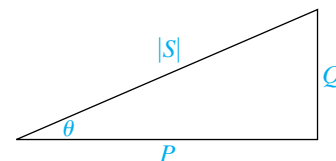


Figure 10.10 ▲ A power triangle.

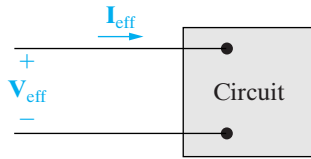
## 10.5 Power Calculations

We are now ready to develop additional equations that can be used to calculate real, reactive, and complex power. We begin by combining Eqs. 10.10, 10.11, and 10.23 to get

$$S = \frac{V_m I_m}{2} \cos(\theta_v - \theta_i) + j \frac{V_m I_m}{2} \sin(\theta_v - \theta_i)$$

$$= \frac{V_m I_m}{2} [\cos(\theta_v - \theta_i) + j \sin(\theta_v - \theta_i)]$$

$$= \frac{V_m I_m}{2} e^{j(\theta_v - \theta_i)} = \frac{1}{2} V_m I_m \angle (\theta_v - \theta_i). \quad (10.27)$$



**Figure 10.11** ▲ The phasor voltage and current associated with a pair of terminals.

If we use the effective values of the sinusoidal voltage and current, Eq. 10.27 becomes

$$S = V_{\text{eff}} I_{\text{eff}} \angle (\theta_v - \theta_i). \quad (10.28)$$

Equations 10.27 and 10.28 are important relationships in power calculations because they show that if the phasor current and voltage are known at a pair of terminals, the complex power associated with that pair of terminals is either one half the product of the voltage and the conjugate of the current, or the product of the rms phasor voltage and the conjugate of the rms phasor current. We can show this for the rms phasor voltage and current in Fig. 10.11 as follows:

$$\begin{aligned} S &= V_{\text{eff}} I_{\text{eff}} \angle (\theta_v - \theta_i) \\ &= V_{\text{eff}} I_{\text{eff}} e^{j(\theta_v - \theta_i)} \\ &= V_{\text{eff}} e^{j\theta_v} I_{\text{eff}} e^{-j\theta_i} \\ &= \mathbf{V}_{\text{eff}} \mathbf{I}_{\text{eff}}^* \end{aligned} \quad (10.29)$$

**Complex power** ►

Note that  $\mathbf{I}_{\text{eff}}^* = I_{\text{eff}} e^{-j\theta_i}$  follows from Euler's identity and the trigonometric identities  $\cos(-\theta) = \cos(\theta)$  and  $\sin(-\theta) = -\sin(\theta)$ :

$$\begin{aligned} I_{\text{eff}} e^{-j\theta_i} &= I_{\text{eff}} \cos(-\theta_i) + j I_{\text{eff}} \sin(-\theta_i) \\ &= I_{\text{eff}} \cos(\theta_i) - j I_{\text{eff}} \sin(\theta_i) \\ &= \mathbf{I}_{\text{eff}}^*. \end{aligned}$$

The same derivation technique could be applied to Eq. 10.27 to yield

$$S = \frac{1}{2} \mathbf{V} \mathbf{I}^*. \quad (10.30)$$

Both Eqs. 10.29 and 10.30 are based on the passive sign convention. If the current reference is in the direction of the voltage rise across the terminals, we insert a minus sign on the right-hand side of each equation.

To illustrate the use of Eq. 10.30 in a power calculation, let's use the same circuit that we used in Example 10.1. Expressed in terms of the phasor representation of the terminal voltage and current,

$$\mathbf{V} = 100 \angle 15^\circ \text{ V},$$

$$\mathbf{I} = 4 \angle -105^\circ \text{ A}.$$

Therefore

$$\begin{aligned} S &= \frac{1}{2} (100 \angle 15^\circ) (4 \angle +105^\circ) = 200 \angle 120^\circ \\ &= -100 + j173.21 \text{ VA}. \end{aligned}$$

Once we calculate the complex power, we can read off both the real and reactive powers, because  $S = P + jQ$ . Thus

$$P = -100 \text{ W},$$

$$Q = 173.21 \text{ VAR}.$$

The interpretations of the algebraic signs on  $P$  and  $Q$  are identical to those given in the solution of Example 10.1.

### Alternate Forms for Complex Power

Equations 10.29 and 10.30 have several useful variations. Here, we use the rms value form of the equations, because rms values are the most common type of representation for voltages and currents in power computations.

The first variation of Eq. 10.29 is to replace the voltage with the product of the current times the impedance. In other words, we can always represent the circuit inside the box of Fig. 10.11 by an equivalent impedance, as shown in Fig. 10.12. Then,

$$\mathbf{V}_{\text{eff}} = Z\mathbf{I}_{\text{eff}}. \quad (10.31)$$

Substituting Eq. 10.31 into Eq. 10.29 yields

$$\begin{aligned} S &= Z\mathbf{I}_{\text{eff}}\mathbf{I}_{\text{eff}}^* \\ &= |\mathbf{I}_{\text{eff}}|^2 Z \\ &= |\mathbf{I}_{\text{eff}}|^2 (R + jX) \\ &= |\mathbf{I}_{\text{eff}}|^2 R + j|\mathbf{I}_{\text{eff}}|^2 X = P + jQ, \end{aligned} \quad (10.32)$$

from which

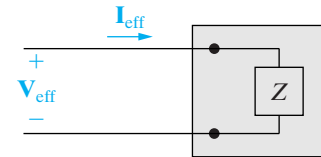
$$P = |\mathbf{I}_{\text{eff}}|^2 R = \frac{1}{2} I_m^2 R, \quad (10.33)$$

$$Q = |\mathbf{I}_{\text{eff}}|^2 X = \frac{1}{2} I_m^2 X. \quad (10.34)$$

In Eq. 10.34,  $X$  is the reactance of either the equivalent inductance or equivalent capacitance of the circuit. Recall from our earlier discussion of reactance that it is positive for inductive circuits and negative for capacitive circuits.

A second useful variation of Eq. 10.29 comes from replacing the current with the voltage divided by the impedance:

$$S = \mathbf{V}_{\text{eff}} \left( \frac{\mathbf{V}_{\text{eff}}}{Z} \right)^* = \frac{|\mathbf{V}_{\text{eff}}|^2}{Z^*} = P + jQ. \quad (10.35)$$



**Figure 10.12** ▲ The general circuit of Fig. 10.11 replaced with an equivalent impedance.

Note that if  $Z$  is a pure resistive element,

$$P = \frac{|\mathbf{V}_{\text{eff}}|^2}{R}, \quad (10.36)$$

and if  $Z$  is a pure reactive element,

$$Q = \frac{|\mathbf{V}_{\text{eff}}|^2}{X}. \quad (10.37)$$

In Eq. 10.37,  $X$  is positive for an inductor and negative for a capacitor.

The following examples demonstrate various power calculations in circuits operating in the sinusoidal steady state.

### Example 10.5 Calculating Average and Reactive Power

In the circuit shown in Fig. 10.13, a load having an impedance of  $39 + j26 \Omega$  is fed from a voltage source through a line having an impedance of  $1 + j4 \Omega$ . The effective, or rms, value of the source voltage is 250 V.

- Calculate the load current  $\mathbf{I}_L$  and voltage  $\mathbf{V}_L$ .
- Calculate the average and reactive power delivered to the load.
- Calculate the average and reactive power delivered to the line.
- Calculate the average and reactive power supplied by the source.

#### Solution

- The line and load impedances are in series across the voltage source, so the load current equals the voltage divided by the total impedance, or

$$\mathbf{I}_L = \frac{250 \angle 0^\circ}{40 + j30} = 4 - j3 = 5 \angle -36.87^\circ \text{ A (rms)}.$$

Because the voltage is given in terms of its rms value, the current also is rms. The load voltage is the product of the load current and load impedance:

$$\begin{aligned} \mathbf{V}_L &= (39 + j26)\mathbf{I}_L = 234 - j13 \\ &= 234.36 \angle -3.18^\circ \text{ V (rms)}. \end{aligned}$$

- The average and reactive power delivered to the load can be computed using Eq. 10.29. Therefore

$$\begin{aligned} S &= \mathbf{V}_L \mathbf{I}_L^* = (234 - j13)(4 + j3) \\ &= 975 + j650 \text{ VA}. \end{aligned}$$

Thus the load is absorbing an average power of 975 W and a reactive power of 650 VAR.

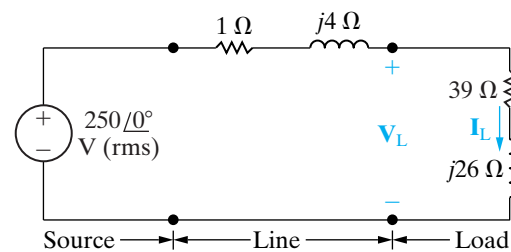


Figure 10.13 ▲ The circuit for Example 10.5.

- The average and reactive power delivered to the line are most easily calculated from Eqs. 10.33 and 10.34 because the line current is known. Thus

$$P = (5)^2(1) = 25 \text{ W},$$

$$Q = (5)^2(4) = 100 \text{ VAR}.$$

Note that the reactive power associated with the line is positive because the line reactance is inductive.

- One way to calculate the average and reactive power delivered by the source is to add the complex power delivered to the line to that delivered to the load, or

$$S = 25 + j100 + 975 + j650$$

$$= 1000 + j750 \text{ VA}.$$

The complex power at the source can also be calculated from Eq. 10.29:

$$S_s = -250\mathbf{I}_L^*.$$



The minus sign is inserted in Eq. 10.29 whenever the current reference is in the direction of a voltage rise. Thus

$$S_s = -250(4 + j3) = -(1000 + j750) \text{ VA.}$$

The minus sign implies that both average power and magnetizing reactive power are being delivered by the source. Note that this result agrees with the previous calculation of  $S$ , as it must, because the source must furnish all the average and reactive power absorbed by the line and load.

### Example 10.6 Calculating Power in Parallel Loads

The two loads in the circuit shown in Fig. 10.14 can be described as follows: Load 1 absorbs an average power of 8 kW at a leading power factor of 0.8. Load 2 absorbs 20 kVA at a lagging power factor of 0.6.

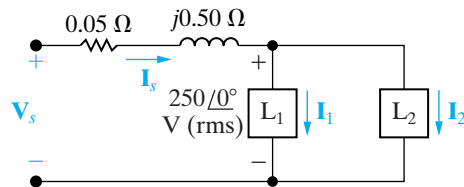


Figure 10.14 ▲ The circuit for Example 10.6.

- Determine the power factor of the two loads in parallel.
- Determine the apparent power required to supply the loads, the magnitude of the current,  $\mathbf{I}_s$ , and the average power loss in the transmission line.
- Given that the frequency of the source is 60 Hz, compute the value of the capacitor that would correct the power factor to 1 if placed in parallel with the two loads. Recompute the values in (b) for the load with the corrected power factor.

### Solution

- All voltage and current phasors in this problem are assumed to represent effective values. Note from the circuit diagram in Fig. 10.14 that  $\mathbf{I}_s = \mathbf{I}_1 + \mathbf{I}_2$ . The total complex power absorbed by the two loads is

$$\begin{aligned} S &= (250)\mathbf{I}_s^* \\ &= (250)(\mathbf{I}_1 + \mathbf{I}_2)^* \\ &= (250)\mathbf{I}_1^* + (250)\mathbf{I}_2^* \\ &= S_1 + S_2. \end{aligned}$$

We can sum the complex powers geometrically, using the power triangles for each load, as shown in Fig. 10.15. By hypothesis,

$$\begin{aligned} S_1 &= 8000 - j \frac{8000(.6)}{(.8)} \\ &= 8000 - j6000 \text{ VA,} \end{aligned}$$

$$\begin{aligned} S_2 &= 20,000(.6) + j20,000(.8) \\ &= 12,000 + j16,000 \text{ VA.} \end{aligned}$$

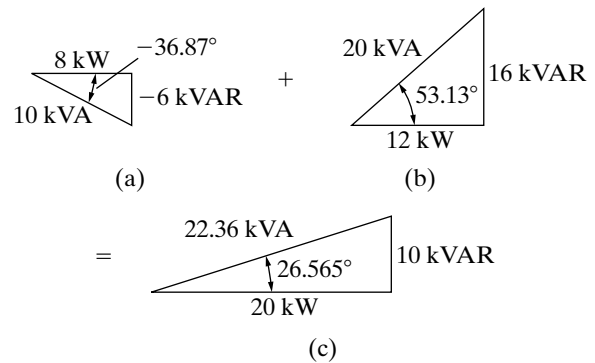


Figure 10.15 ▲ (a) The power triangle for load 1. (b) The power triangle for load 2. (c) The sum of the power triangles.

It follows that

$$S = 20,000 + j10,000 \text{ VA,}$$

and

$$\mathbf{I}_s^* = \frac{20,000 + j10,000}{250} = 80 + j40 \text{ A.}$$

Therefore

$$\mathbf{I}_s = 80 - j40 = 89.44 \angle -26.57^\circ \text{ A.}$$

Thus the power factor of the combined load is

$$\text{pf} = \cos(0 + 26.57^\circ) = 0.8944 \text{ lagging.}$$

The power factor of the two loads in parallel is lagging because the net reactive power is positive.

- The apparent power which must be supplied to these loads is

$$|S| = |20 + j10| = 22.36 \text{ kVA.}$$

The magnitude of the current that supplies this apparent power is

$$|\mathbf{I}_s| = |80 - j40| = 89.44 \text{ A.}$$

The average power lost in the line results from the current flowing through the line resistance:

$$P_{\text{line}} = |\mathbf{I}_s|^2 R = (89.44)^2(0.05) = 400 \text{ W}$$

Note that the power supplied totals  $20,000 + 400 = 20,400 \text{ W}$ , even though the loads require a total of only  $20,000 \text{ W}$ .

- c) As we can see from the power triangle in Fig. 10.15(c), we can correct the power factor to 1 if we place a capacitor in parallel with the existing loads such that the capacitor supplies  $10 \text{ kVAR}$  of magnetizing reactive power. The value of the capacitor is calculated as follows. First, find the capacitive reactance from Eq. 10.37:

$$\begin{aligned} X &= \frac{|V_{\text{eff}}|^2}{Q} \\ &= \frac{(250)^2}{-10,000} \\ &= -6.25 \Omega. \end{aligned}$$

Recall that the reactive impedance of a capacitor is  $-1/\omega C$ , and  $\omega = 2\pi(60) = 376.99 \text{ rad/s}$ , if the source frequency is  $60 \text{ Hz}$ . Thus,

$$C = \frac{-1}{\omega X} = \frac{-1}{(376.99)(-6.25)} = 424.4 \mu\text{F}.$$

The addition of the capacitor as the third load is represented in geometric form as the sum of the two power triangles shown in Fig. 10.16. When

the power factor is 1, the apparent power and the average power are the same, as seen from the power triangle in Fig. 10.16(c). Therefore, the apparent power once the power factor has been corrected is

$$|S| = P = 20 \text{ kVA}.$$

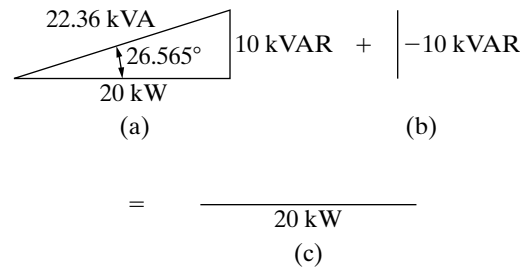
The magnitude of the current that supplies this apparent power is

$$|\mathbf{I}_s| = \frac{20,000}{250} = 80 \text{ A}.$$

The average power lost in the line is thus reduced to

$$P_{\text{line}} = |\mathbf{I}_s|^2 R = (80)^2(0.05) = 320 \text{ W}.$$

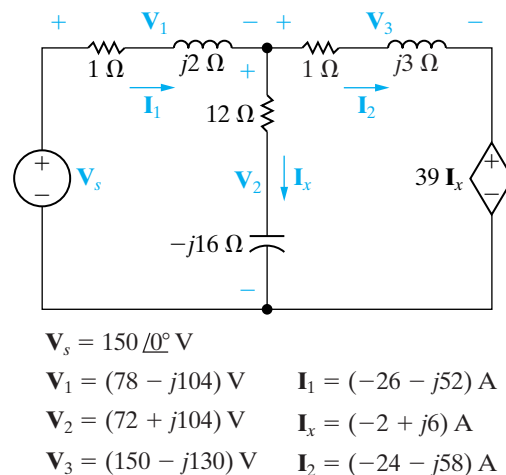
Now, the power supplied totals  $20,000 + 320 = 20,320 \text{ W}$ . Note that the addition of the capacitor has reduced the line loss from  $400 \text{ W}$  to  $320 \text{ W}$ .



**Figure 10.16** (a) The sum of the power triangles for loads 1 and 2. (b) The power triangle for a  $424.4 \mu\text{F}$  capacitor at  $60 \text{ Hz}$ . (c) The sum of the power triangles in (a) and (b).

**Example 10.7** Balancing Power Delivered with Power Absorbed in an ac Circuit

- a) Calculate the total average and reactive power delivered to each impedance in the circuit shown in Fig. 10.17.
- b) Calculate the average and reactive powers associated with each source in the circuit.
- c) Verify that the average power delivered equals the average power absorbed, and that the magnetizing reactive power delivered equals the magnetizing reactive power absorbed.



**Figure 10.17** The circuit, with solution, for Example 10.7.

**Solution**

- a) The complex power delivered to the  $(1 + j2) \Omega$  impedance is

$$\begin{aligned} S_1 &= \frac{1}{2} \mathbf{V}_1 \mathbf{I}_1^* = P_1 + jQ_1 \\ &= \frac{1}{2} (78 - j104)(-26 + j52) \\ &= \frac{1}{2} (3380 + j6760) \\ &= 1690 + j3380 \text{ VA.} \end{aligned}$$

Thus this impedance is absorbing an average power of 1690 W and a reactive power of 3380 VAR. The complex power delivered to the  $(12 - j16) \Omega$  impedance is

$$\begin{aligned} S_2 &= \frac{1}{2} \mathbf{V}_2 \mathbf{I}_x^* = P_2 + jQ_2 \\ &= \frac{1}{2} (72 + j104)(-2 - j6) \\ &= 240 - j320 \text{ VA.} \end{aligned}$$

Therefore the impedance in the vertical branch is absorbing 240 W and delivering 320 VAR. The complex power delivered to the  $(1 + j3) \Omega$  impedance is

$$\begin{aligned} S_3 &= \frac{1}{2} \mathbf{V}_3 \mathbf{I}_2^* = P_3 + jQ_3 \\ &= \frac{1}{2} (150 - j130)(-24 + j58) \\ &= 1970 + j5910 \text{ VA.} \end{aligned}$$

This impedance is absorbing 1970 W and 5910 VAR.

- b) The complex power associated with the independent voltage source is

$$\begin{aligned} S_s &= -\frac{1}{2} \mathbf{V}_s \mathbf{I}_1^* = P_s + jQ_s \\ &= -\frac{1}{2} (150)(-26 + j52) \\ &= 1950 - j3900 \text{ VA.} \end{aligned}$$

Note that the independent voltage source is absorbing an average power of 1950 W and delivering 3900 VAR. The complex power associated with the current-controlled voltage source is

$$\begin{aligned} S_x &= \frac{1}{2} (39 \mathbf{I}_x)(\mathbf{I}_2^*) = P_x + jQ_x \\ &= \frac{1}{2} (-78 + j234)(-24 + j58) \\ &= -5850 - j5070 \text{ VA.} \end{aligned}$$

Both average power and magnetizing reactive power are being delivered by the dependent source.

- c) The total power absorbed by the passive impedances and the independent voltage source is

$$P_{\text{absorbed}} = P_1 + P_2 + P_3 + P_s = 5850 \text{ W.}$$

The dependent voltage source is the only circuit element delivering average power. Thus

$$P_{\text{delivered}} = 5850 \text{ W.}$$

Magnetizing reactive power is being absorbed by the two horizontal branches. Thus

$$Q_{\text{absorbed}} = Q_1 + Q_3 = 9290 \text{ VAR.}$$

Magnetizing reactive power is being delivered by the independent voltage source, the capacitor in the vertical impedance branch, and the dependent voltage source. Therefore

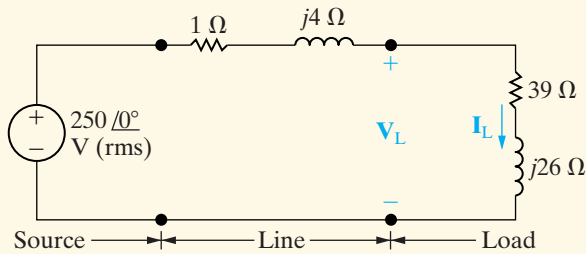
$$Q_{\text{delivered}} = 9290 \text{ VAR.}$$

**ASSESSMENT PROBLEMS**

**Objective 1—Understand ac power concepts, their relationships to one another, and how to calculate them in a circuit**

**10.4** The load impedance in the circuit shown is shunted by a capacitor having a capacitive reactance of  $-52 \Omega$ . Calculate:

- a) the rms phasors  $\mathbf{V}_L$  and  $\mathbf{I}_L$ ,
- b) the average power and magnetizing reactive power absorbed by the  $(39 + j26) \Omega$  load impedance,
- c) the average power and magnetizing reactive power absorbed by the  $(1 + j4) \Omega$  line impedance,
- d) the average power and magnetizing reactive power delivered by the source, and
- e) the magnetizing reactive power delivered by the shunting capacitor.



**Answer:** (a)  $252.20 \angle -4.54^\circ \text{ V (rms)}$ ,  
 $5.38 \angle -38.23^\circ \text{ A (rms)}$ ;  
 (b)  $1129.09 \text{ W}$ ,  $752.73 \text{ VAR}$ ;

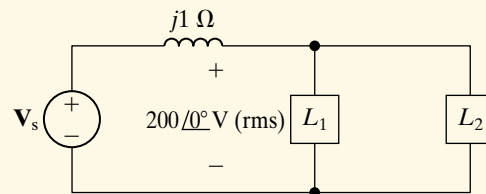
*NOTE: Also try Chapter Problems 10.20, 10.28, and 10.30.*

- (c)  $23.52 \text{ W}$ ,  $94.09 \text{ VAR}$ ;
- (d)  $1152.62 \text{ W}$ ,  $-376.36 \text{ VAR}$ ;
- (e)  $1223.18 \text{ VAR}$ .

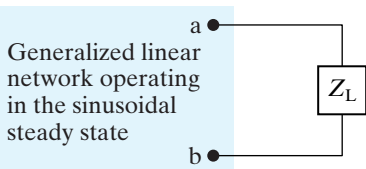
**10.5** The rms voltage at the terminals of a load is 250 V. The load is absorbing an average power of 40 kW and delivering a magnetizing reactive power of 30 kVAR. Derive two equivalent impedance models of the load.

**Answer:**  $1 \Omega$  in series with  $0.75 \Omega$  of capacitive reactance;  $1.5625 \Omega$  in parallel with  $2.083 \Omega$  of capacitive reactance.

**10.6** Find the phasor voltage  $\mathbf{V}_s$  (rms) in the circuit shown if loads  $L_1$  and  $L_2$  are absorbing 15 kVA at 0.6 pf lagging and 6 kVA at 0.8 pf leading, respectively. Express  $\mathbf{V}_s$  in polar form.



**Answer:**  $251.64 \angle 15.91^\circ \text{ V}$ .



**Figure 10.18** ▲ A circuit describing maximum power transfer.

## 10.6 Maximum Power Transfer

Recall from Chapter 4 that certain systems—for example, those that transmit information via electric signals—depend on being able to transfer a maximum amount of power from the source to the load. We now reexamine maximum power transfer in the context of a sinusoidal steady-state network, beginning with Fig. 10.18. We must determine the load impedance  $Z_L$  that results in the delivery of maximum average power to terminals a and b. Any linear network may be viewed from the terminals of the load in terms of a Thévenin equivalent circuit. Thus the task reduces to finding the value of  $Z_L$  that results in maximum average power delivered to  $Z_L$  in the circuit shown in Fig. 10.19.

For maximum average power transfer,  $Z_L$  must equal the conjugate of the Thévenin impedance; that is,

**Condition for maximum average power transfer** ►

$$Z_L = Z_{Th}^* \tag{10.38}$$

We derive Eq. 10.38 by a straightforward application of elementary calculus. We begin by expressing  $Z_{\text{Th}}$  and  $Z_{\text{L}}$  in rectangular form:

$$Z_{\text{Th}} = R_{\text{Th}} + jX_{\text{Th}}, \quad (10.39)$$

$$Z_{\text{L}} = R_{\text{L}} + jX_{\text{L}}. \quad (10.40)$$

In both Eqs. 10.39 and 10.40, the reactance term carries its own algebraic sign—positive for inductance and negative for capacitance. Because we are making an average-power calculation, we assume that the amplitude of the Thévenin voltage is expressed in terms of its rms value. We also use the Thévenin voltage as the reference phasor. Then, from Fig. 10.19, the rms value of the load current  $\mathbf{I}$  is

$$\mathbf{I} = \frac{\mathbf{V}_{\text{Th}}}{(R_{\text{Th}} + R_{\text{L}}) + j(X_{\text{Th}} + X_{\text{L}})}. \quad (10.41)$$

The average power delivered to the load is

$$P = |\mathbf{I}|^2 R_{\text{L}}. \quad (10.42)$$

Substituting Eq. 10.41 into Eq. 10.42 yields

$$P = \frac{|\mathbf{V}_{\text{Th}}|^2 R_{\text{L}}}{(R_{\text{Th}} + R_{\text{L}})^2 + (X_{\text{Th}} + X_{\text{L}})^2}. \quad (10.43)$$

When working with Eq. 10.43, always remember that  $V_{\text{Th}}$ ,  $R_{\text{Th}}$ , and  $X_{\text{Th}}$  are fixed quantities, whereas  $R_{\text{L}}$  and  $X_{\text{L}}$  are independent variables. Therefore, to maximize  $P$ , we must find the values of  $R_{\text{L}}$  and  $X_{\text{L}}$  where  $\partial P/\partial R_{\text{L}}$  and  $\partial P/\partial X_{\text{L}}$  are both zero. From Eq. 10.43,

$$\frac{\partial P}{\partial X_{\text{L}}} = \frac{-|\mathbf{V}_{\text{Th}}|^2 2R_{\text{L}}(X_{\text{L}} + X_{\text{Th}})}{[(R_{\text{L}} + R_{\text{Th}})^2 + (X_{\text{L}} + X_{\text{Th}})^2]^2}, \quad (10.44)$$

$$\frac{\partial P}{\partial R_{\text{L}}} = \frac{|\mathbf{V}_{\text{Th}}|^2 [(R_{\text{L}} + R_{\text{Th}})^2 + (X_{\text{L}} + X_{\text{Th}})^2 - 2R_{\text{L}}(R_{\text{L}} + R_{\text{Th}})]}{[(R_{\text{L}} + R_{\text{Th}})^2 + (X_{\text{L}} + X_{\text{Th}})^2]^2}. \quad (10.45)$$

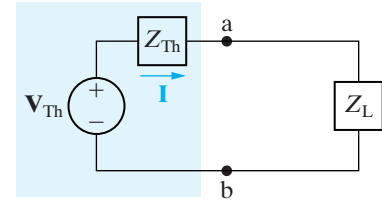
From Eq. 10.44,  $\partial P/\partial X_{\text{L}}$  is zero when

$$X_{\text{L}} = -X_{\text{Th}}. \quad (10.46)$$

From Eq. 10.45,  $\partial P/\partial R_{\text{L}}$  is zero when

$$R_{\text{L}} = \sqrt{R_{\text{Th}}^2 + (X_{\text{L}} + X_{\text{Th}})^2}. \quad (10.47)$$

Note that when we combine Eq. 10.46 with Eq. 10.47, both derivatives are zero when  $Z_{\text{L}} = Z_{\text{Th}}^*$ .



**Figure 10.19** ▲ The circuit shown in Fig. 10.18, with the network replaced by its Thévenin equivalent.

## The Maximum Average Power Absorbed

The maximum average power that can be delivered to  $Z_L$  when it is set equal to the conjugate of  $Z_{Th}$  is calculated directly from the circuit in Fig. 10.19. When  $Z_L = Z_{Th}^*$ , the rms load current is  $V_{Th}/2R_L$ , and the maximum average power delivered to the load is

$$P_{\max} = \frac{|V_{Th}|^2 R_L}{4R_L^2} = \frac{1}{4} \frac{|V_{Th}|^2}{R_L}. \quad (10.48)$$

If the Thévenin voltage is expressed in terms of its maximum amplitude rather than its rms amplitude, Eq. 10.48 becomes

$$P_{\max} = \frac{1}{8} \frac{V_m^2}{R_L}. \quad (10.49)$$

## Maximum Power Transfer When $Z$ is Restricted

Maximum average power can be delivered to  $Z_L$  only if  $Z_L$  can be set equal to the conjugate of  $Z_{Th}$ . There are situations in which this is not possible. First,  $R_L$  and  $X_L$  may be restricted to a limited range of values. In this situation, the optimum condition for  $R_L$  and  $X_L$  is to adjust  $X_L$  as near to  $-X_{Th}$  as possible and then adjust  $R_L$  as close to  $\sqrt{R_{Th}^2 + (X_L + X_{Th})^2}$  as possible (see Example 10.9).

A second type of restriction occurs when the magnitude of  $Z_L$  can be varied but its phase angle cannot. Under this restriction, the greatest amount of power is transferred to the load when the magnitude of  $Z_L$  is set equal to the magnitude of  $Z_{Th}$ ; that is, when

$$|Z_L| = |Z_{Th}|. \quad (10.50)$$

The proof of Eq. 10.50 is left to you as Problem 10.45.

For purely resistive networks, maximum power transfer occurs when the load resistance equals the Thévenin resistance. Note that we first derived this result in the introduction to maximum power transfer in Chapter 4.

Examples 10.8–10.11 illustrate the problem of obtaining maximum power transfer in the situations just discussed.

### Example 10.8 Determining Maximum Power Transfer without Load Restrictions

- For the circuit shown in Fig. 10.20, determine the impedance  $Z_L$  that results in maximum average power transferred to  $Z_L$ .
- What is the maximum average power transferred to the load impedance determined in (a)?

#### Solution

- We begin by determining the Thévenin equivalent with respect to the load terminals a, b. After two source transformations involving the 20 V source, the 5  $\Omega$  resistor, and the 20  $\Omega$  resistor, we

simplify the circuit shown in Fig. 10.20 to the one shown in Fig. 10.21. Then,

$$\begin{aligned} V_{Th} &= \frac{16 \angle 0^\circ}{4 + j3 - j6} (-j6) \\ &= 19.2 \angle -53.13^\circ = 11.52 - j15.36 \text{ V.} \end{aligned}$$

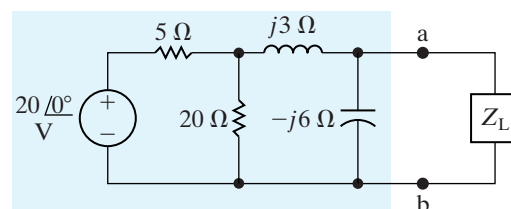
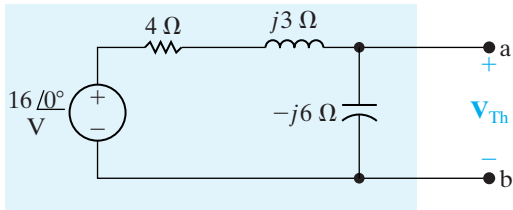


Figure 10.20 ▲ The circuit for Example 10.8.



**Figure 10.21** ▲ A simplification of Fig. 10.20 by source transformations.

We find the Thévenin impedance by deactivating the independent source and calculating the impedance seen looking into the terminals a and b. Thus,

$$Z_{\text{Th}} = \frac{(-j6)(4 + j3)}{4 + j3 - j6} = 5.76 - j1.68 \Omega.$$

For maximum average power transfer, the load impedance must be the conjugate of  $Z_{\text{Th}}$ , so

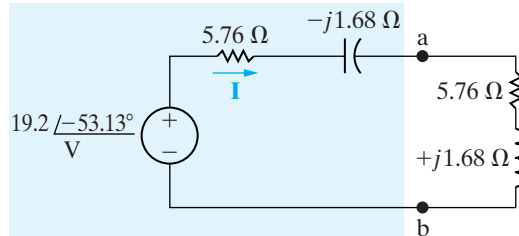
$$Z_L = 5.76 + j1.68 \Omega.$$

- b) We calculate the maximum average power delivered to  $Z_L$  from the circuit shown in Fig. 10.22, in

which we replaced the original network with its Thévenin equivalent. From Fig. 10.22, the rms magnitude of the load current  $\mathbf{I}$  is

$$I_{\text{eff}} = \frac{19.2/\sqrt{2}}{2(5.76)} = 1.1785 \text{ A.}$$

The average power delivered to the load is



**Figure 10.22** ▲ The circuit shown in Fig. 10.20, with the original network replaced by its Thévenin equivalent.

$$P = I_{\text{eff}}^2(5.76) = 8 \text{ W.}$$

### Example 10.9 Determining Maximum Power Transfer with Load Impedance Restriction

- a) For the circuit shown in Fig. 10.23, what value of  $Z_L$  results in maximum average power transfer to  $Z_L$ ? What is the maximum power in milliwatts?
- b) Assume that the load resistance can be varied between 0 and 4000  $\Omega$  and that the capacitive reactance of the load can be varied between 0 and -2000  $\Omega$ . What settings of  $R_L$  and  $X_L$  transfer the most average power to the load? What is the maximum average power that can be transferred under these restrictions?

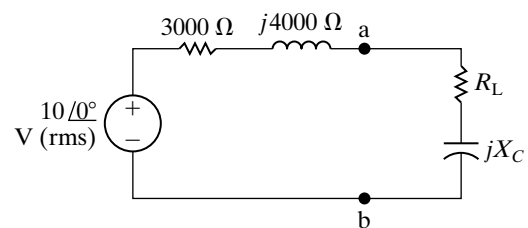
#### Solution

- a) If there are no restrictions on  $R_L$  and  $X_L$ , the load impedance is set equal to the conjugate of the output or the Thévenin impedance. Therefore we set

$$R_L = 3000 \Omega \quad \text{and} \quad X_L = -4000 \Omega,$$

or

$$Z_L = 3000 - j4000 \Omega.$$



**Figure 10.23** ▲ The circuit for Examples 10.9 and 10.10.

Because the source voltage is given in terms of its rms value, the average power delivered to  $Z_L$  is

$$P = \frac{1}{4} \frac{10^2}{3000} = \frac{25}{3} \text{ mW} = 8.33 \text{ mW.}$$

- b) Because  $R_L$  and  $X_L$  are restricted, we first set  $X_L$  as close to -4000  $\Omega$  as possible; thus  $X_L = -2000 \Omega$ . Next, we set  $R_L$  as close to  $\sqrt{R_{\text{Th}}^2 + (X_L + X_{\text{Th}})^2}$  as possible. Thus

$$R_L = \sqrt{3000^2 + (-2000 + 4000)^2} = 3605.55 \Omega.$$



Now, because  $R_L$  can be varied from 0 to 4000  $\Omega$ , we can set  $R_L$  to 3605.55  $\Omega$ . Therefore, the load impedance is adjusted to a value of

$$Z_L = 3605.55 - j2000 \Omega.$$

With  $Z_L$  set at this value, the value of the load current is

$$\mathbf{I}_{\text{eff}} = \frac{10 \angle 0^\circ}{6605.55 + j2000} = 1.4489 \angle -16.85^\circ \text{ mA}.$$

The average power delivered to the load is

$$P = (1.4489 \times 10^{-3})^2(3605.55) = 7.57 \text{ mW}.$$

This quantity is the maximum power that we can deliver to a load, given the restrictions on  $R_L$  and  $X_L$ . Note that this is less than the power that can be delivered if there are no restrictions; in (a) we found that we can deliver 8.33 mW.

### Example 10.10 Finding Maximum Power Transfer with Impedance Angle Restrictions

A load impedance having a constant phase angle of  $-36.87^\circ$  is connected across the load terminals a and b in the circuit shown in Fig. 10.23. The magnitude of  $Z_L$  is varied until the average power delivered is the most possible under the given restriction.

- Specify  $Z_L$  in rectangular form.
- Calculate the average power delivered to  $Z_L$ .

#### Solution

- From Eq. 10.50, we know that the magnitude of  $Z_L$  must equal the magnitude of  $Z_{\text{Th}}$ . Therefore

$$|Z_L| = |Z_{\text{Th}}| = |3000 + j4000| = 5000 \Omega.$$

Now, as we know that the phase angle of  $Z_L$  is  $-36.87^\circ$ , we have

$$Z_L = 5000 \angle -36.87^\circ = 4000 - j3000 \Omega.$$

- With  $Z_L$  set equal to  $4000 - j3000 \Omega$ , the load current is

$$\mathbf{I}_{\text{eff}} = \frac{10}{7000 + j1000} = 1.4142 \angle -8.13^\circ \text{ mA},$$

and the average power delivered to the load is

$$P = (1.4142 \times 10^{-3})^2(4000) = 8 \text{ mW}.$$

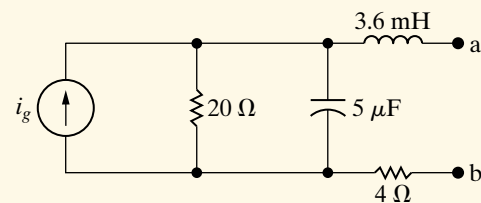
This quantity is the maximum power that can be delivered by this circuit to a load impedance whose angle is constant at  $-36.87^\circ$ . Again, this quantity is less than the maximum power that can be delivered if there are no restrictions on  $Z_L$ .

## ASSESSMENT PROBLEM

### Objective 2—Understand the condition for maximum real power delivered to a load in an ac circuit

10.7 The source current in the circuit shown is  $3 \cos 5000t$  A.

- What impedance should be connected across terminals a,b for maximum average power transfer?
- What is the average power transferred to the impedance in (a)?
- Assume that the load is restricted to pure resistance. What size resistor connected across a,b will result in the maximum average power transferred?
- What is the average power transferred to the resistor in (c)?



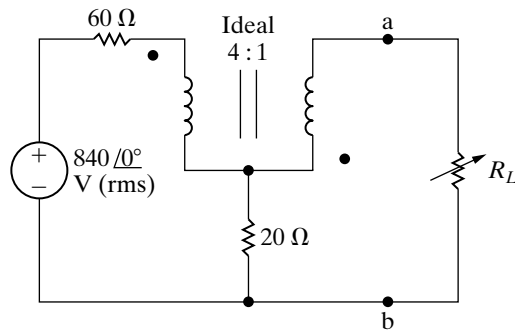
- Answer:** (a)  $20 - j10 \Omega$ ;  
 (b) 18 W;  
 (c) 22.36  $\Omega$ ;  
 (d) 17.00 W.

NOTE: Also try Chapter Problems 10.41, 10.48, and 10.62.

**Example 10.11** Finding Maximum Power Transfer in a Circuit with an Ideal Transformer

The variable resistor in the circuit in Fig. 10.24 is adjusted until maximum average power is delivered to  $R_L$ .

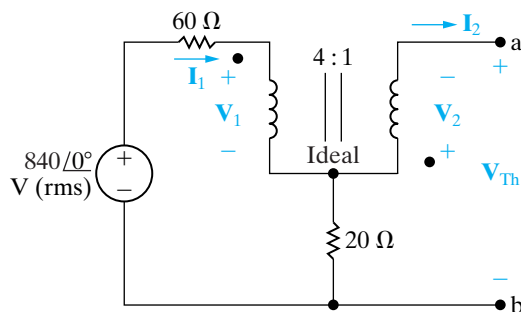
- What is the value of  $R_L$  in ohms?
- What is the maximum average power (in watts) delivered to  $R_L$ ?



**Figure 10.24** ▲ The circuit for Example 10.11.

**Solution**

- We first find the Thévenin equivalent with respect to the terminals of  $R_L$ . The circuit for determining the open circuit voltage is shown in Fig. 10.25. The variables  $\mathbf{V}_1$ ,  $\mathbf{V}_2$ ,  $\mathbf{I}_1$ , and  $\mathbf{I}_2$  have been added to expedite the discussion.



**Figure 10.25** ▲ The circuit used to find the Thévenin voltage.

First we note the ideal transformer imposes the following constraints on the variables  $\mathbf{V}_1$ ,  $\mathbf{V}_2$ ,  $\mathbf{I}_1$ , and  $\mathbf{I}_2$ :

$$\mathbf{V}_2 = \frac{1}{4}\mathbf{V}_1, \quad \mathbf{I}_1 = -\frac{1}{4}\mathbf{I}_2.$$

The open circuit value of  $\mathbf{I}_2$  is zero, hence  $\mathbf{I}_1$  is zero. It follows that

$$\mathbf{V}_1 = 840 \angle 0^\circ \text{ V}, \quad \mathbf{V}_2 = 210 \angle 0^\circ \text{ V}.$$

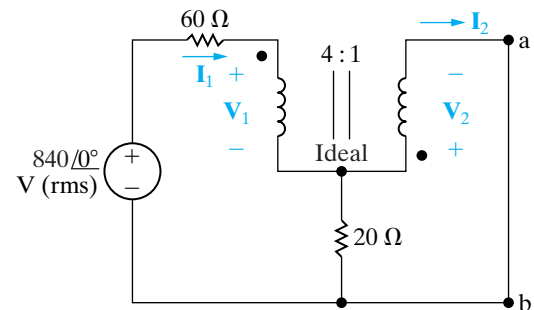
From Fig. 10.25 we note that  $\mathbf{V}_{Th}$  is the negative of  $\mathbf{V}_2$ , hence

$$\mathbf{V}_{Th} = -210 \angle 0^\circ \text{ V}.$$

The circuit shown in Fig. 10.26 is used to determine the short circuit current. Viewing  $\mathbf{I}_1$  and  $\mathbf{I}_2$  as mesh currents, the two mesh equations are

$$840 \angle 0^\circ = 80\mathbf{I}_1 - 20\mathbf{I}_2 + \mathbf{V}_1,$$

$$0 = 20\mathbf{I}_2 - 20\mathbf{I}_1 + \mathbf{V}_2.$$



**Figure 10.26** ▲ The circuit used to calculate the short circuit current.

When these two mesh current equations are combined with the constraint equations we get

$$840 \angle 0^\circ = -40\mathbf{I}_2 + \mathbf{V}_1,$$

$$0 = 25\mathbf{I}_2 + \frac{\mathbf{V}_1}{4}.$$

Solving for the short circuit value of  $\mathbf{I}_2$  yields

$$\mathbf{I}_2 = -6 \text{ A}.$$

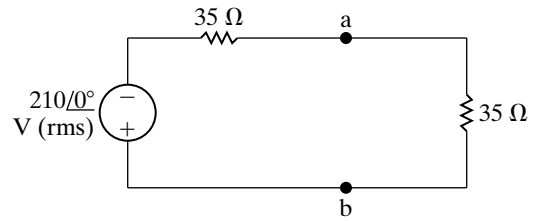
Therefore the Thévenin resistance is

$$R_{Th} = \frac{-210}{-6} = 35 \Omega.$$

Maximum power will be delivered to  $R_L$  when  $R_L$  equals  $35\ \Omega$ .

- b) The maximum power delivered to  $R_L$  is most easily determined using the Thévenin equivalent. From the circuit shown in Fig. 10.27 we have

$$P_{\max} = \left( \frac{-210}{70} \right)^2 (35) = 315\ \text{W}.$$

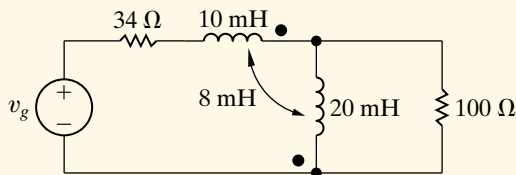


**Figure 10.27** ▲ The Thévenin equivalent loaded for maximum power transfer.

## ASSESSMENT PROBLEMS

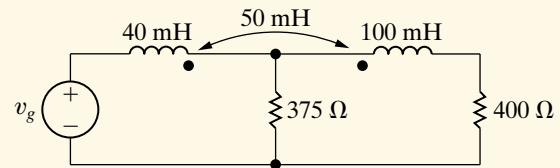
**Objective 3**—Be able to calculate all forms of ac power in ac circuits with linear transformers and ideal transformers

- 10.8** Find the average power delivered to the  $100\ \Omega$  resistor in the circuit shown if  $v_g = 660 \cos 5000t\ \text{V}$ .



**Answer:** 612.5 W.

- 10.9** a) Find the average power delivered to the  $400\ \Omega$  resistor in the circuit shown if  $v_g = 248 \cos 10,000t\ \text{V}$ .  
 b) Find the average power delivered to the  $375\ \Omega$  resistor.  
 c) Find the power developed by the ideal voltage source. Check your result by showing the power absorbed equals the power developed.



**Answer:** (a) 50 W;  
 (b) 49.2 W;  
 (c) 99.2 W,  $50 + 49.2 = 99.2\ \text{W}$ .

- 10.10** Solve Example 10.11 if the polarity dot on the coil connected to terminal a is at the top.

**Answer:** (a)  $15\ \Omega$ ;  
 (b) 735 W.

- 10.11** Solve Example 10.11 if the voltage source is reduced to  $146\ \angle 0^\circ\ \text{V rms}$  and the turns ratio is reversed to 1:4.

**Answer:** (a)  $1460\ \Omega$ ;  
 (b) 58.4 W.

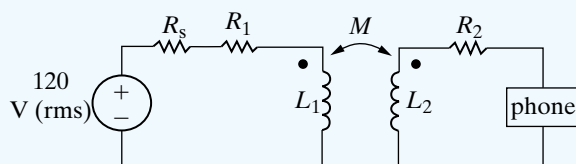
*NOTE:* Also try Chapter Problems 10.61 and 10.62.

## Practical Perspective

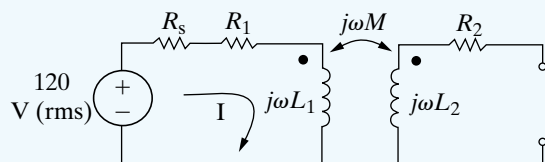
### Vampire Power

Vampire power, or standby power, may cost you more than you think. The average household has about 40 electrical products that draw power, even when turned off. Approximately 5% of typical residential power consumption can be attributed to standby power. Table 10.3 provides the power consumption of several different devices. Notice that when a device is considered to be off, it is often still consuming power.

Consider a typical mobile phone charger. According to the values given in Table 10.3, when the charger is detached from the phone it consumes only a fraction of the power that is used when the charger is attached to the phone and the phone is charging. Suppose you charge your phone for three hours each day, but leave the charger plugged into the wall outlet 24 hours a day. Recall that the electric company bills you based on the number of kilowatt-hours (kWh) you use in a given month. A device that uses 1000 W of power



**Figure 10.28** ▲ A linear transformer used in a phone charger.



**Figure 10.29** ▲ The phone charger circuit when the phone is not connected.

**TABLE 10.3** Average power consumption of common electrical devices

Electrical device <sup>+</sup>	Power [W]*
Mobile phone charger	
Attached to phone, phone charging	3.68
Plugged into wall outlet but not into phone	0.26
Notebook computer AC adapter	
Attached to computer, computer charging	44.28
Attached to computer, computer sleeping	15.77
Attached to computer, computer off	8.9
Plugged into wall outlet but not into computer	4.42
DVD player	
On and playing	9.91
On and not playing	7.54
Off	1.55
Microwave oven	
Ready with door closed	3.08
Ready with door open	25.79
Cooking	1433.0
Inkjet multifunction printer	
On	9.16
Off	5.26

\*Data in this table from Lawrence Berkeley National Laboratory report (<http://standby.lbl.gov/standby.html>)

<sup>+</sup>This value is the average of the power measured for many types of each device

continuously over one hour has consumed 1 kWh. Let's calculate the number of kilowatt-hours used by the phone charger in one month.

$$P[\text{kWh}] = \frac{30[3(3.68) + 21(0.26)]}{1000} = 1.8 \text{ kWh}$$

Now do the calculation again, this time assuming that you unplug the charger when it is not being used to charge the phone.

$$P[\text{kWh}] = \frac{30[3(3.68) + 21(0)]}{1000} = 0.33 \text{ kWh}$$

Keeping the charger plugged in when you are not using it causes the charger to consume more than 5 times the power needed to charge your phone every day. You can therefore minimize the cost of vampire power by unplugging electrical devices if they are not being used.

How can the phone charger consume power when not plugged into the phone? The electronic circuitry in your phone uses 5 V(dc) sources to supply power. The phone charger must transform the 120 V(rms) signal supplied by the wall outlet into a signal that can be used to charge the phone. Phone chargers can use linear transformers, together with other circuitry, to output a voltage suited to the phone.

Consider the circuit in Fig. 10.28. The linear transformer is part of the circuitry used to reduce the voltage supplied by the source to a level suited to the phone. The additional components needed to complete this task are not shown in the circuit. When the phone is unplugged from the circuit in Fig. 10.28, but the circuit is still connected to the 120 V(rms) source, there is still a path for the current, as shown in Fig. 10.29. The current is

$$I = \frac{120}{R_s + R_1 + j\omega L_1}$$

The real power, delivered by the voltage source and supplied to the resistors, is

$$P = (R_s + R_1)|I|^2$$

This is the vampire power being consumed by the phone charger even when it is not connected to the phone.

**NOTE:** Assess your understanding of this Practical Perspective by trying Chapter Problems 10.66–10.68.

## Summary

- **Instantaneous power** is the product of the instantaneous terminal voltage and current, or  $p = \pm vi$ . The positive sign is used when the reference direction for the current is from the positive to the negative reference polarity of the voltage. The frequency of the instantaneous power is twice the frequency of the voltage (or current). (See page 360.)

- **Average power** is the average value of the instantaneous power over one period. It is the power converted from electric to nonelectric form and vice versa. This conversion is the reason that average power is also referred to as real power. Average power, with the passive sign convention, is expressed as

$$P = \frac{1}{2}V_m I_m \cos(\theta_v - \theta_i)$$

$$= V_{\text{eff}} I_{\text{eff}} \cos(\theta_v - \theta_i).$$

(See page 362.)

- **Reactive power** is the electric power exchanged between the magnetic field of an inductor and the source that drives it or between the electric field of a capacitor and the source that drives it. Reactive power is never converted to nonelectric power. Reactive power, with the passive sign convention, is expressed as

$$Q = \frac{1}{2}V_m I_m \sin(\theta_v - \theta_i)$$

$$= V_{\text{eff}} I_{\text{eff}} \sin(\theta_v - \theta_i).$$

Both average power and reactive power can be expressed in terms of either peak ( $V_m$ ,  $I_m$ ) or effective ( $V_{\text{eff}}$ ,  $I_{\text{eff}}$ ) current and voltage. Effective values are widely used in both household and industrial applications. *Effective value* and *rms value* are interchangeable terms for the same value. (See page 362.)

- The **power factor** is the cosine of the phase angle between the voltage and the current:

$$\text{pf} = \cos(\theta_v - \theta_i).$$

The terms *lagging* and *leading* added to the description of the power factor indicate whether the current is lagging or leading the voltage and thus whether the load is inductive or capacitive. (See page 363.)

- The **reactive factor** is the sine of the phase angle between the voltage and the current:

$$\text{rf} = \sin(\theta_v - \theta_i).$$

(See page 363.)

- **Complex power** is the complex sum of the real and reactive powers, or

$$S = P + jQ$$

$$= \frac{1}{2}\mathbf{V}\mathbf{I}^* = \mathbf{V}_{\text{eff}}\mathbf{I}_{\text{eff}}^*$$

$$= I_{\text{eff}}^2 Z = \frac{V_{\text{eff}}^2}{Z^*}.$$

(See page 368.)

- **Apparent power** is the magnitude of the complex power:

$$|S| = \sqrt{P^2 + Q^2}.$$

(See page 368.)

- The **watt** is used as the unit for both instantaneous and real power. The **var** (volt amp reactive, or VAR) is used as the unit for reactive power. The **volt-amp** (VA) is used as the unit for complex and apparent power. (See page 368.)

- **Maximum power transfer** occurs in circuits operating in the sinusoidal steady state when the load impedance is the conjugate of the Thévenin impedance as viewed from the terminals of the load impedance. (See page 376.)

## Problems

### Sections 10.1–10.2

**10.1** The following sets of values for  $v$  and  $i$  pertain to the circuit seen in Fig. 10.1. For each set of values, calculate  $P$  and  $Q$  and state whether the circuit inside the box is absorbing or delivering (1) average power and (2) magnetizing vars.

- $v = 250 \cos(\omega t + 45^\circ) \text{ V}$ ,  
 $i = 4 \sin(\omega t + 60^\circ) \text{ A}$ .
- $v = 18 \cos(\omega t - 30^\circ) \text{ V}$ ,  
 $i = 5 \cos(\omega t - 75^\circ) \text{ A}$ .
- $v = 150 \sin(\omega t + 25^\circ) \text{ V}$ ,  
 $i = 2 \cos(\omega t + 50^\circ) \text{ A}$ .
- $v = 80 \cos(\omega t + 120^\circ) \text{ V}$ ,  
 $i = 10 \cos(\omega t + 170^\circ) \text{ A}$ .

- 10.2** a) A college student wakes up hungry. He turns on the coffee maker, puts some oatmeal in the microwave oven to cook, puts a couple of slices of bread in the toaster, and starts making scrambled eggs in the electric frying pan. If all of these appliances in his dorm room are supplied by a 120 V branch circuit protected by a 50 A circuit breaker, will the breaker interrupt his breakfast?
- b) The student's roommate wakes up and turns on the air conditioner. He realizes that the room is a mess, so starts to vacuum. Now does the circuit breaker interrupt breakfast?

**10.3** Show that the maximum value of the instantaneous power given by Eq. 10.9 is  $P + \sqrt{P^2 + Q^2}$  and that the minimum value is  $P - \sqrt{P^2 + Q^2}$ .

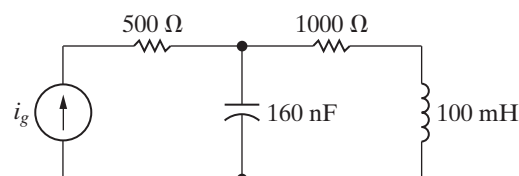
**10.4** A load consisting of a  $480 \Omega$  resistor in parallel with a  $(5/9) \mu\text{F}$  capacitor is connected across the terminals of a sinusoidal voltage source  $v_g$ , where  $v_g = 240 \cos 5000t \text{ V}$ .

- What is the peak value of the instantaneous power delivered by the source?
- What is the peak value of the instantaneous power absorbed by the source?
- What is the average power delivered to the load?
- What is the reactive power delivered to the load?
- Does the load absorb or generate magnetizing vars?
- What is the power factor of the load?
- What is the reactive factor of the load?

**10.5** Find the average power delivered by the ideal current source in the circuit in Fig. P10.5 if  $i_g = 4 \cos 5000t \text{ mA}$ .

PSPICE  
MULTISIM

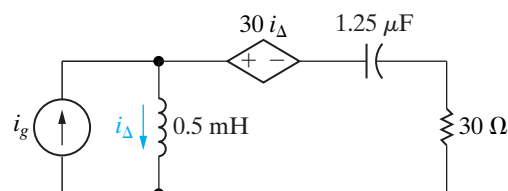
Figure P10.5



**10.6** Find the average power dissipated in the  $30 \Omega$  resistor in the circuit seen in Fig. P10.6 if  $i_g = 6 \cos 20,000t \text{ A}$ .

PSPICE  
MULTISIM

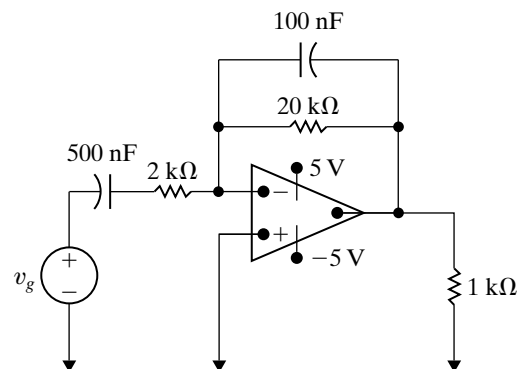
Figure P10.6



**10.7** The op amp in the circuit shown in Fig. P10.7 is ideal. Calculate the average power delivered to the  $1 \text{ k}\Omega$  resistor when  $v_g = \cos 1000t \text{ V}$ .

PSPICE  
MULTISIM

Figure P10.7



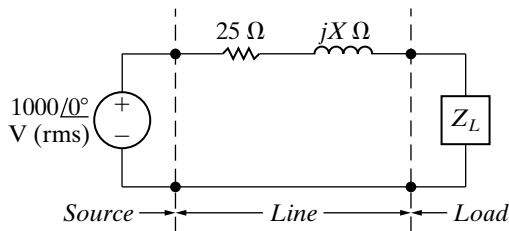
- 10.8** a) Calculate the real and reactive power associated with each circuit element in the circuit in Fig. P9.63.
- b) Verify that the average power generated equals the average power absorbed.
- c) Verify that the magnetizing vars generated equal the magnetizing vars absorbed.

**10.9** Repeat Problem 10.8 for the circuit shown in Fig. P9.64.

**10.10** The load impedance in Fig. P10.10 absorbs 6 kW and generates 8 kVAR. The sinusoidal voltage source develops 8 kW.

- Find the values of inductive line reactance that will satisfy these constraints.
- For each value of line reactance found in (a), show that the magnetizing vars developed equals the magnetizing vars absorbed.

Figure P10.10

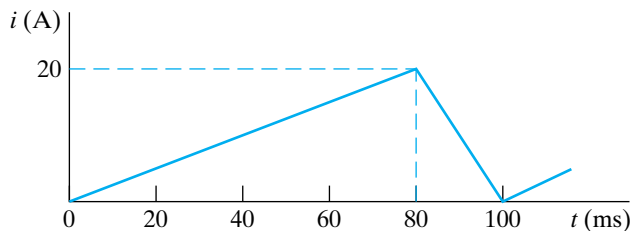


**Section 10.3**

- A personal computer with a monitor and keyboard requires 40 W at 115 V (rms). Calculate the rms value of the current carried by its power cord.
- A laser printer for the personal computer in (a) is rated at 90 W at 115 V (rms). If this printer is plugged into the same wall outlet as the computer, what is the rms value of the current drawn from the outlet?

**10.12** Find the rms value of the periodic current shown in Fig. P10.12.

Figure P10.12

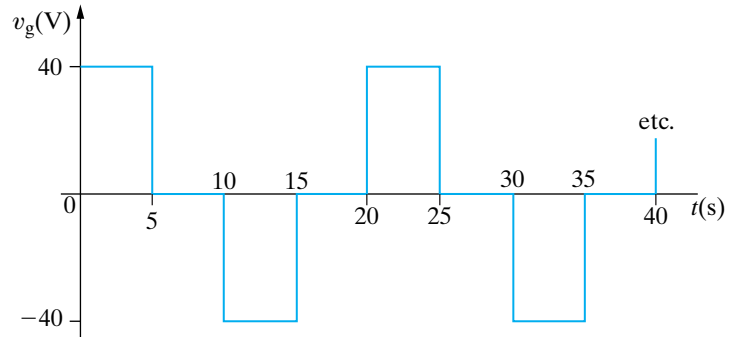


**10.13** The periodic current shown in Fig. P10.12 dissipates an average power of 1280 W in a resistor. What is the value of the resistor?

**10.14** a) Find the rms value of the periodic voltage shown in Fig. P10.14.

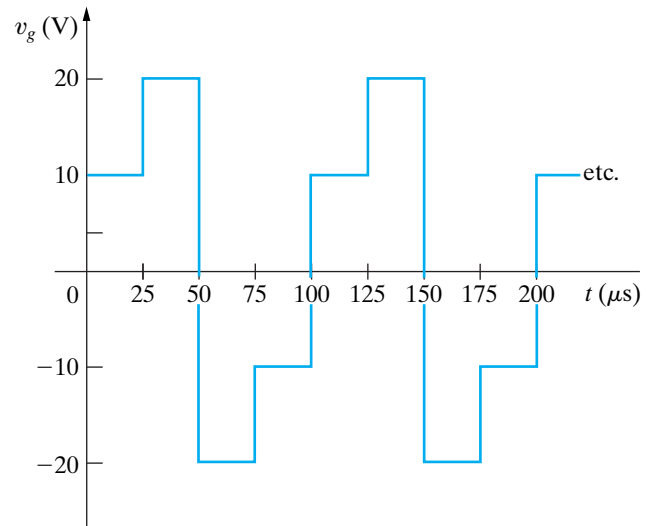
- Suppose the voltage in part (a) is applied to the terminals of a 40 Ω resistor. Calculate the average power dissipated by the resistor.
- When the voltage in part (a) is applied to a different resistor, that resistor dissipates 10 mW of average power. What is the value of the resistor?

Figure P10.14



- Find the rms value of the periodic voltage shown in Fig. P10.15.
- If this voltage is applied to the terminals of a 4 Ω resistor, what is the average power dissipated in the resistor?

Figure P10.15



**10.16** A dc voltage equal to  $V_{dc}$  V is applied to a resistor of  $R$  Ω. A sinusoidal voltage equal to  $v_s$  V is also applied to a resistor of  $R$  Ω. Show that the dc voltage will deliver the same amount of energy in  $T$  seconds (where  $T$  is the period of the sinusoidal voltage) as



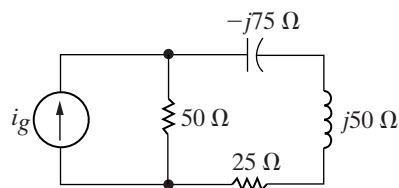
the sinusoidal voltage provided  $V_{dc}$  equals the rms value of  $v_s$ . (Hint: Equate the two expressions for the energy delivered to the resistor.)

### Sections 10.4–10.5

**10.17** The current  $I_g$  in the frequency-domain circuit shown in Fig. P10.17 is  $50 \angle 0^\circ$  mA (rms).

- Find the average and reactive power for the current source.
- Is the current source absorbing or delivering average power?
- Is the current source absorbing or delivering magnetizing vars?
- Find the average and reactive powers associated with each impedance branch in the circuit.
- Check the balance between delivered and absorbed average power.
- Check the balance between delivered and absorbed magnetizing vars.

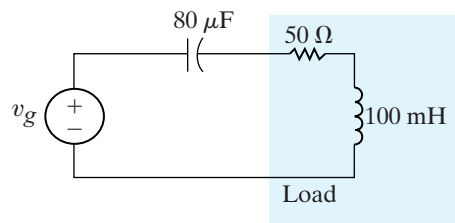
Figure P10.17



**10.18** Find the average power, the reactive power, and the apparent power absorbed by the load in the circuit in Fig. P10.18 if  $v_g$  equals  $150 \cos 250t$  V.

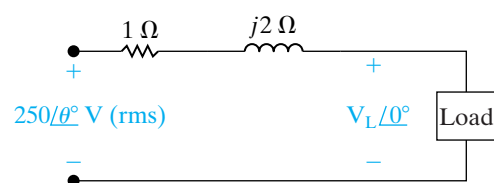
PSPICE  
MULTISIM

Figure P10.18



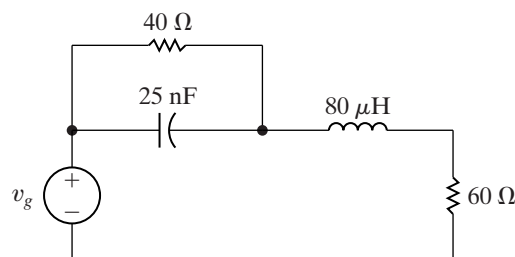
- Find  $V_L$  (rms) and  $\theta$  for the circuit in Fig. P10.19 if the load absorbs 2500 VA at a lagging power factor of 0.8.
- Construct a phasor diagram of each solution obtained in (a).

Figure P10.19



- Find the average power, the reactive power, and the apparent power supplied by the voltage source in the circuit in Fig. P10.20 if  $v_g = 40 \cos 10^6 t$  V.
- Check your answer in (a) by showing  $P_{dev} = \sum P_{abs}$ .
- Check your answer in (a) by showing  $Q_{dev} = \sum Q_{abs}$ .

Figure P10.20

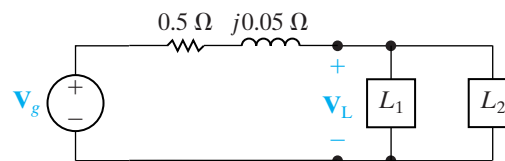


**10.21** Two 480 V (rms) loads are connected in parallel. The two loads draw a total average power of 40,800 W at a power factor of 0.8 lagging. One of the loads draws 20 kVA at a power factor of 0.96 leading. What is the power factor of the other load?

**10.22** The two loads shown in Fig. P10.22 can be described as follows: Load 1 absorbs an average power of 10 kW and delivers 4 kVAR of reactive power; Load 2 has an impedance of  $(60 + j80)\Omega$ . The voltage at the terminals of the loads is  $1000\sqrt{2} \cos 100\pi t$  V.

- Find the rms value of the source voltage.
- By how many microseconds is the load voltage out of phase with the source voltage?
- Does the load voltage lead or lag the source voltage?

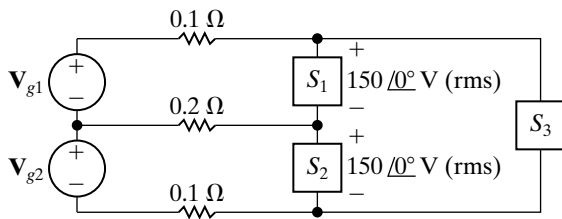
Figure P10.22



**10.23** The three loads in the circuit seen in Fig. P10.23 are  $S_1 = 6 + j3$  kVA,  $S_2 = 7.5 - j4.5$  kVA,  $S_3 = 12 + j9$  kVA.

- Calculate the complex power associated with each voltage source,  $V_{g1}$  and  $V_{g2}$ .
- Verify that the total real and reactive power delivered by the sources equals the total real and reactive power absorbed by the network.

Figure P10.23



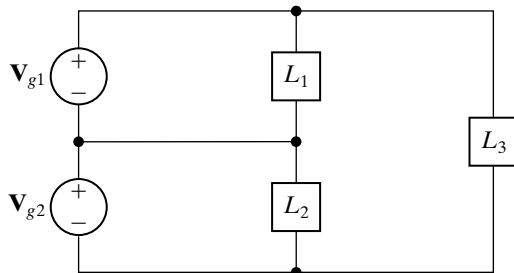
**10.24** The three loads in the circuit seen in Fig. P10.24 are described as follows: Load 1 is absorbing 4.8 kW and delivering 2.4 kVAR; Load 2 is absorbing 6 kVA at a power factor of 0.8 lagging; Load 3 is a  $24 \Omega$  resistor in parallel with an inductance whose reactance is  $6 \Omega$ .

- Calculate the average power and the magnetizing reactive power delivered by each source if  $V_{g1} = V_{g2} = 120 \angle 0^\circ \text{ V (rms)}$ .
- Check your calculations by showing your results are consistent with the requirements

$$\sum P_{\text{dev}} = \sum P_{\text{abs}}$$

$$\sum Q_{\text{dev}} = \sum Q_{\text{abs}}$$

Figure P10.24

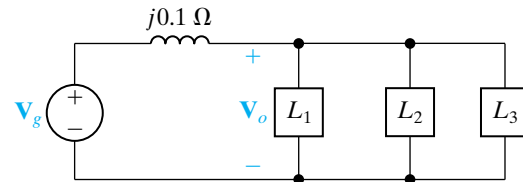


**10.25** Suppose the circuit shown in Fig. P10.24 represents a residential distribution circuit in which the impedances of the service conductors are negligible and  $V_{g1} = V_{g2} = 110 \angle 0^\circ \text{ V (rms)}$ . The three loads in the circuit are  $L_1$  (a toaster, a coffee maker, and a microwave oven);  $L_2$  (a solid-state TV, a vacuum cleaner, and a portable heater); and  $L_3$  (an automatic washing machine and a clothes dryer). Assume that all of these appliances are in operation at the same time. The service conductors are protected with 50 A circuit breakers. Will the service to this residence be interrupted? Why or why not?

**10.26** The three parallel loads in the circuit shown in Fig. 10.26 can be described as follows: Load 1 is absorbing an average power of 6 kW and delivering reactive power of 8 kvars; Load 2 is absorbing an

average power of 9 kW and reactive power of 3 kvars; Load 3 is a  $25 \Omega$  resistor in parallel with a capacitor whose reactance is  $-5 \Omega$ . Find the rms magnitude and the phase angle of  $V_o$  if  $V_o = 250 \angle 0^\circ \text{ V}$ .

Figure P10.26



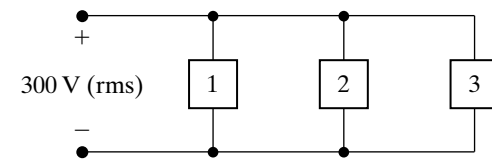
**10.27** Consider the circuit described in Problem 9.78.

- What is the rms magnitude of the voltage across the load impedance?
- What percentage of the average power developed by the practical source is delivered to the load impedance?

**10.28** Three loads are connected in parallel across a 300 V(rms) line, as shown in Fig. P10.28. Load 1 absorbs 3 kW at unity power factor; Load 2 absorbs 5 kVA at 0.8 leading; Load 3 absorbs 5 kW and delivers 6 kvars.

- Find the impedance that is equivalent to the three parallel loads.
- Find the power factor of the equivalent load as seen from the line's input terminals.

Figure P10.28

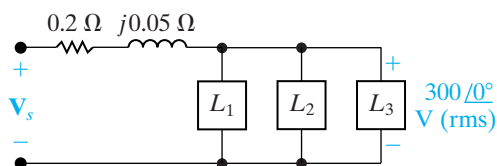


**10.29** The three loads in Problem 10.28 are fed from a line having a series impedance  $0.02 + j0.05 \Omega$ , as shown in Fig. P10.29.

- Calculate the rms value of the voltage ( $V_s$ ) at the sending end of the line.
- Calculate the average and reactive powers associated with the line impedance.
- Calculate the average and reactive powers at the sending end of the line.
- Calculate the efficiency ( $\eta$ ) of the line if the efficiency is defined as

$$\eta = (P_{\text{load}}/P_{\text{sending end}}) \times 100.$$

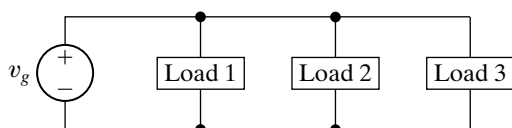
Figure P10.29



**10.30** The three loads in the circuit in Fig. P10.30 can be described as follows: Load 1 is a  $240\ \Omega$  resistor in series with an inductive reactance of  $70\ \Omega$ ; load 2 is a capacitive reactance of  $120\ \Omega$  in series with a  $160\ \Omega$  resistor; and load 3 is a  $30\ \Omega$  resistor in series with a capacitive reactance of  $40\ \Omega$ . The frequency of the voltage source is  $60\ \text{Hz}$ .

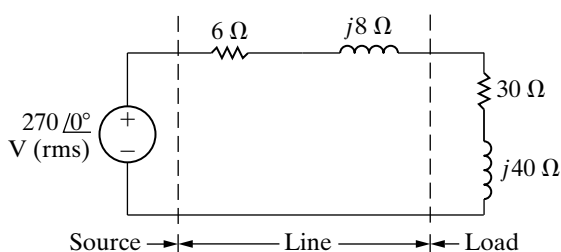
- Give the power factor and reactive factor of each load.
- Give the power factor and reactive factor of the composite load seen by the voltage source.

Figure P10.30



- Find the average power dissipated in the line in Fig. P10.31.
- Find the capacitive reactance that when connected in parallel with the load will make the load look purely resistive.
- What is the equivalent impedance of the load in (b)?
- Find the average power dissipated in the line when the capacitive reactance is connected across the load.
- Express the power loss in (d) as a percentage of the power loss found in (a).

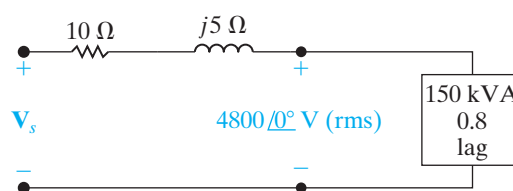
Figure P10.31



**10.32** The steady-state voltage drop between the load and the sending end of the line seen in Fig. P10.32 is excessive. A capacitor is placed in parallel with the  $150\ \text{kVA}$  load and is adjusted until the steady-state voltage at the sending end of the line has the same

magnitude as the voltage at the load end, that is,  $4800\ \text{V}$  (rms). The  $150\ \text{kVA}$  load is operating at a power factor of  $0.8$  lag. Calculate the size of the capacitor in microfarads if the circuit is operating at  $60\ \text{Hz}$ . In selecting the capacitor, keep in mind the need to keep the power loss in the line at a reasonable level.

Figure P10.32



**10.33** A group of small appliances on a  $60\ \text{Hz}$  system requires  $20\ \text{kVA}$  at  $0.85$  pf lagging when operated at  $125\ \text{V}$  (rms). The impedance of the feeder supplying the appliances is  $0.01 + j0.08\ \Omega$ . The voltage at the load end of the feeder is  $125\ \text{V}$  (rms).

- What is the rms magnitude of the voltage at the source end of the feeder?
- What is the average power loss in the feeder?
- What size capacitor (in microfarads) across the load end of the feeder is needed to improve the load power factor to unity?
- After the capacitor is installed, what is the rms magnitude of the voltage at the source end of the feeder if the load voltage is maintained at  $125\ \text{V}$  (rms)?
- What is the average power loss in the feeder for (d)?

**10.34** A factory has an electrical load of  $1600\ \text{kW}$  at a lagging power factor of  $0.8$ . An additional variable power factor load is to be added to the factory. The new load will add  $320\ \text{kW}$  to the real power load of the factory. The power factor of the added load is to be adjusted so that the overall power factor of the factory is  $0.96$  lagging.

- Specify the reactive power associated with the added load.
- Does the added load absorb or deliver magnetizing vars?
- What is the power factor of the additional load?
- Assume that the voltage at the input to the factory is  $2400\ \text{V}$  (rms). What is the rms magnitude of the current into the factory before the variable power factor load is added?
- What is the rms magnitude of the current into the factory after the variable power factor load has been added?

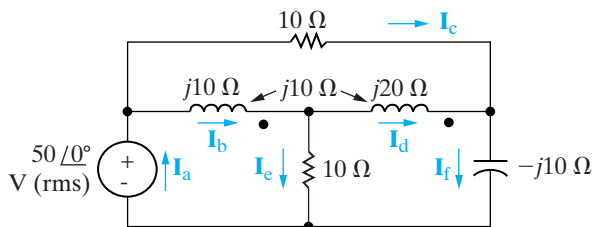
**10.35** Assume the factory described in Problem 10.34 is fed from a line having an impedance of  $0.25 + j0.1 \Omega$ . The voltage at the factory is maintained at 2400 V (rms).

- Find the average power loss in the line before and after the load is added.
- Find the magnitude of the voltage at the sending end of the line before and after the load is added.

**10.36** a) Find the six branch currents  $I_a - I_f$  in the circuit in Fig. P10.36.

- Find the complex power in each branch of the circuit.
- Check your calculations by verifying that the average power developed equals the average power dissipated.
- Check your calculations by verifying that the magnetizing vars generated equal the magnetizing vars absorbed.

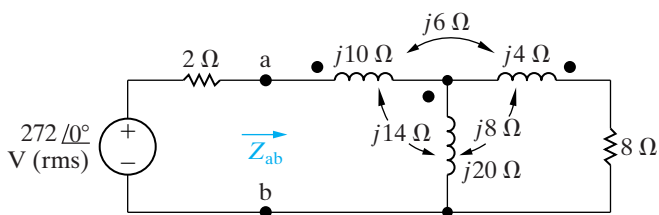
Figure P10.36



**10.37** a) Find the average power delivered to the 8 Ω resistor in the circuit in Fig. P10.37.

- Find the average power developed by the ideal sinusoidal voltage source.
- Find  $Z_{ab}$ .
- Show that the average power developed equals the average power dissipated.

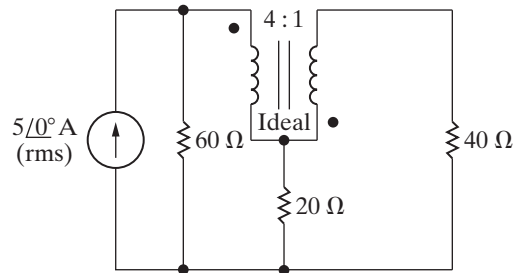
Figure P10.37



**10.38** a) Find the average power delivered by the sinusoidal current source in the circuit of Fig. P10.38.

- Find the average power delivered to the 20 Ω resistor.

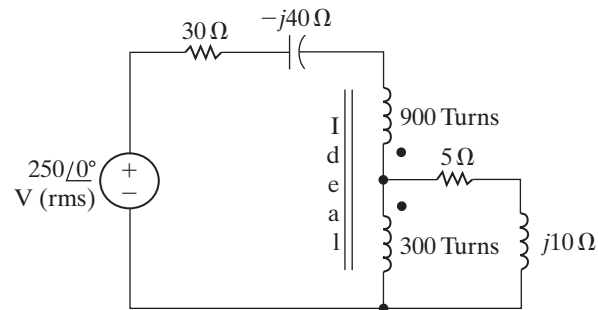
Figure P10.38



**10.39** a) Find the average power dissipated in each resistor in the circuit in Fig. P10.39.

- Check your answer by showing that the total power developed equals the total power absorbed.

Figure P10.39

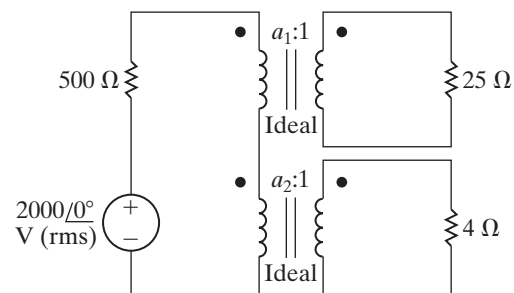


**10.40** The sinusoidal voltage source in the circuit in Fig. P10.40 is developing an rms voltage of 2000 V.

The 4 Ω load in the circuit is absorbing four times as much average power as the 25 Ω load. The two loads are matched to the sinusoidal source that has an internal impedance of  $500∠0° \text{ k}\Omega$ .

- Specify the numerical values of  $a_1$  and  $a_2$ .
- Calculate the power delivered to the 25 Ω load.
- Calculate the rms value of the voltage across the 4 Ω resistor.

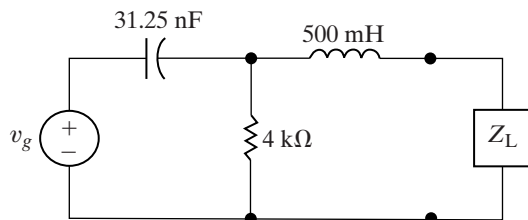
Figure P10.40



## Section 10.6

- 10.41** a) Determine the load impedance for the circuit shown in Fig. P10.41 that will result in maximum average power being transferred to the load if  $\omega = 8 \text{ krad/s}$ .
- b) Determine the maximum average power delivered to the load from part (a) if  $v_g = 10 \cos 8000t \text{ V}$ .
- c) Repeat part (a) when  $Z_L$  consists of two components from Appendix H whose values yield a maximum average power closest to the value calculated in part (b).

Figure P10.41



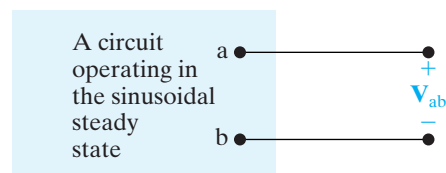
- 10.42** Suppose an impedance equal to the conjugate of the Thévenin impedance is connected to the terminals c, d of the circuit shown in Fig. P9.75.

- a) Find the average power developed by the sinusoidal voltage source.
- b) What percentage of the power developed by the source is lost in the linear transformer?

- 10.43** The phasor voltage  $\mathbf{V}_{ab}$  in the circuit shown in Fig. P10.43 is  $300 \angle 0^\circ \text{ V (rms)}$  when no external load is connected to the terminals a, b. When a load having an impedance of  $200 - j500 \Omega$  is connected across a, b, the value of  $\mathbf{V}_{ab}$  is  $156 - j42 \text{ V (rms)}$ .

- a) Find the impedance that should be connected across a, b for maximum average power transfer.
- b) Find the maximum average power transferred to the load of (a).
- c) Construct the impedance of part (a) using components from Appendix H if the source frequency is 50 Hz.

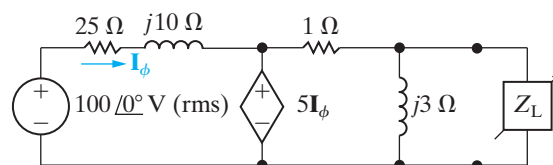
Figure P10.43



- 10.44** The load impedance  $Z_L$  for the circuit shown in Fig. P10.44 is adjusted until maximum average power is delivered to  $Z_L$ .

- a) Find the maximum average power delivered to  $Z_L$ .
- b) What percentage of the total power developed in the circuit is delivered to  $Z_L$ ?

Figure P10.44

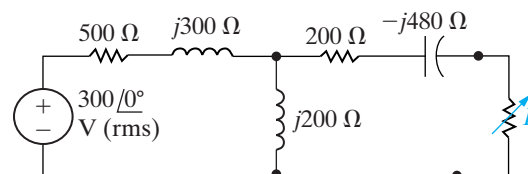


- 10.45** Prove that if only the magnitude of the load impedance can be varied, most average power is transferred to the load when  $|Z_L| = |Z_{Th}|$ . (Hint: In deriving the expression for the average load power, write the load impedance ( $Z_L$ ) in the form  $Z_L = |Z_L| \cos \theta + j|Z_L| \sin \theta$ , and note that only  $|Z_L|$  is variable.)

- 10.46** The variable resistor in the circuit shown in Fig. P10.46 is adjusted until the average power it absorbs is maximum.

- a) Find  $R$ .
- b) Find the maximum average power.
- c) Find a resistor in Appendix H that would have the most average power delivered to it.

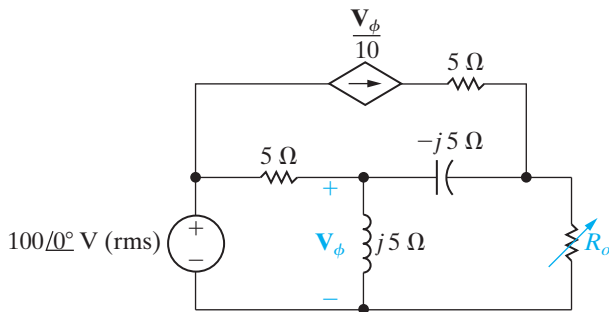
Figure P10.46



- 10.47** The variable resistor  $R_o$  in the circuit shown in Fig. P10.47 is adjusted until maximum average power is delivered to  $R_o$ .

- a) What is the value of  $R_o$  in ohms?
- b) Calculate the average power delivered to  $R_o$ .
- c) If  $R_o$  is replaced with a variable impedance  $Z_o$ , what is the maximum average power that can be delivered to  $Z_o$ ?
- d) In (c), what percentage of the circuit's developed power is delivered to the load  $Z_o$ ?

Figure P10.47

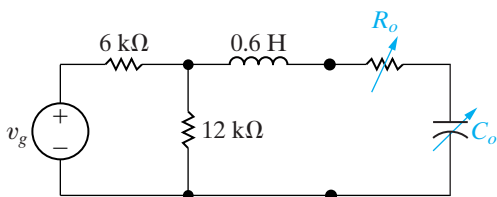


**10.48** The peak amplitude of the sinusoidal voltage source in the circuit shown in Fig. P10.48 is 180 V, and its frequency is 5000 rad/s. The load resistor can be varied from 0 to 4000 Ω, and the load capacitor can be varied from 0.1 μF to 0.5 μF.

PSPICE  
MULTISIM

- Calculate the average power delivered to the load when  $R_o = 2000 \Omega$  and  $C_o = 0.2 \mu\text{F}$ .
- Determine the settings of  $R_o$  and  $C_o$  that will result in the most average power being transferred to  $R_o$ .
- What is the average power in (b)? Is it greater than the power in (a)?
- If there are no constraints on  $R_o$  and  $C_o$ , what is the maximum average power that can be delivered to a load?
- What are the values of  $R_o$  and  $C_o$  for the condition of (d)?
- Is the average power calculated in (d) larger than that calculated in (c)?

Figure P10.48



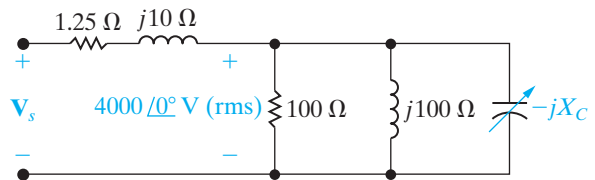
- 10.49**
- Assume that  $R_o$  in Fig. P10.48 can be varied between 0 and 10 kΩ. Repeat (b) and (c) of Problem 10.48.
  - Is the new average power calculated in (a) greater than that found in Problem 10.48(a)?
  - Is the new average power calculated in (a) less than that found in 10.48(d)?

**10.50** The sending-end voltage in the circuit seen in Fig. P10.50 is adjusted so that the rms value of the load voltage is always 4000 V. The variable

capacitor is adjusted until the average power dissipated in the line resistance is minimum.

- If the frequency of the sinusoidal source is 60 Hz, what is the value of the capacitance in microfarads?
- If the capacitor is removed from the circuit, what percentage increase in the magnitude of  $V_s$  is necessary to maintain 4000 V at the load?
- If the capacitor is removed from the circuit, what is the percentage increase in line loss?

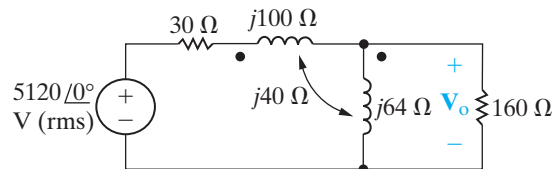
Figure P10.50



**10.51** For the frequency-domain circuit in Fig. P10.51, calculate:

- the rms magnitude of  $V_o$ .
- the average power dissipated in the 160 Ω resistor.
- the percentage of the average power generated by the ideal voltage source that is delivered to the 9 Ω load resistor.

Figure P10.51



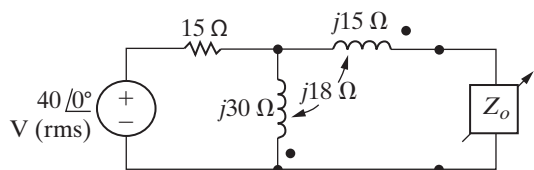
**10.52** The 160 Ω resistor in the circuit in Fig. P10.51 is replaced with a variable impedance  $Z_o$ . Assume  $Z_o$  is adjusted for maximum average power transfer to  $Z_o$ .

- What is the maximum average power that can be delivered to  $Z_o$ ?
- What is the average power developed by the ideal voltage source when maximum average power is delivered to  $Z_o$ ?
- Choose single components from Appendix H to form an impedance that dissipates average power closest to the value in part (a). Assume the source frequency is 60 Hz.

**10.53** Find the impedance seen by the ideal voltage source in the circuit in Fig. P10.53 when  $Z_o$  is adjusted for maximum average power transfer to  $Z_o$ .



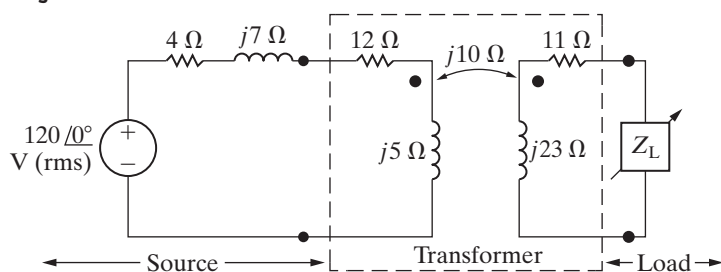
Figure P10.53



**10.54** The impedance  $Z_L$  in the circuit in Fig. P10.54 is adjusted for maximum average power transfer to  $Z_L$ . The internal impedance of the sinusoidal voltage source is  $4 + j7 \Omega$ .

- What is the maximum average power delivered to  $Z_L$ ?
- What percentage of the average power delivered to the linear transformer is delivered to  $Z_L$ ?

Figure P10.54

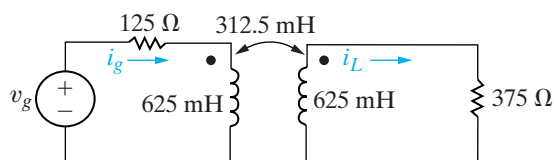


**10.55** a) Find the steady-state expression for the currents  $i_g$  and  $i_L$  in the circuit in Fig. P10.55 when  $v_g = 400 \cos 400t$  V.

PSPICE  
MULTISIM

- Find the coefficient of coupling.
- Find the energy stored in the magnetically coupled coils at  $t = 1.25\pi$  ms and  $t = 2.5\pi$  ms.
- Find the power delivered to the  $375 \Omega$  resistor.
- If the  $375 \Omega$  resistor is replaced by a variable resistor  $R_L$ , what value of  $R_L$  will yield maximum average power transfer to  $R_L$ ?
- What is the maximum average power in (e)?
- Assume the  $375 \Omega$  resistor is replaced by a variable impedance  $Z_L$ . What value of  $Z_L$  will result in maximum average power transfer to  $Z_L$ ?
- What is the maximum average power in (g)?

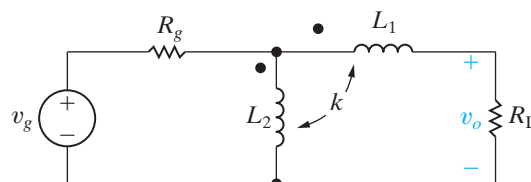
Figure P10.55



**10.56** The values of the parameters in the circuit shown in Fig. P10.56 are  $L_1 = 8$  mH;  $L_2 = 2$  mH;  $k = 0.75$ ;  $R_g = 1 \Omega$ ; and  $R_L = 7 \Omega$ . If  $v_g = 54\sqrt{2} \cos 1000t$  V, find

- the rms magnitude of  $v_o$
- the average power delivered to  $R_L$
- the percentage of the average power generated by the ideal voltage source that is delivered to  $R_L$ .

Figure P10.56



**10.57** Assume the coefficient of coupling in the circuit in Fig. P10.56 is adjustable.

- Find the value of  $k$  that makes  $v_o$  equal to zero.
- Find the power developed by the source when  $k$  has the value found in (a).

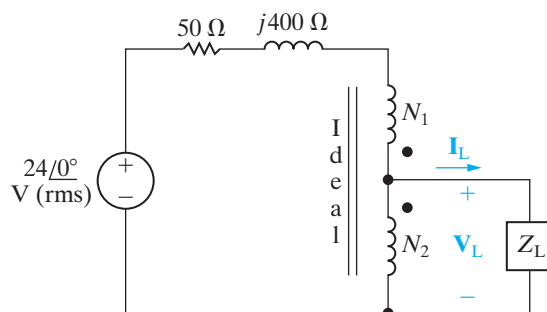
**10.58** Assume the load resistor ( $R_L$ ) in the circuit in Fig. P10.56 is adjustable.

- What value of  $R_L$  will result in the maximum average power being transferred to  $R_L$ ?
- What is the value of the maximum power transferred?

**10.59** The load impedance  $Z_L$  in the circuit in Fig. P10.59 is adjusted until maximum average power is transferred to  $Z_L$ .

- Specify the value of  $Z_L$  if  $N_1 = 3600$  turns and  $N_2 = 600$  turns.
- Specify the values of  $\mathbf{I}_L$  and  $\mathbf{V}_L$  when  $Z_L$  is absorbing maximum average power.

Figure P10.59

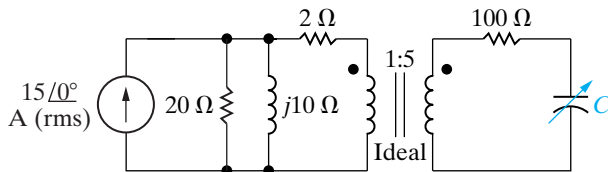




**10.60** The sinusoidal voltage source in the circuit in Fig. P10.60 is operating at a frequency of 20 krad/s. The variable capacitive reactance in the circuit is adjusted until the average power delivered to the 100 Ω resistor is as large as possible.

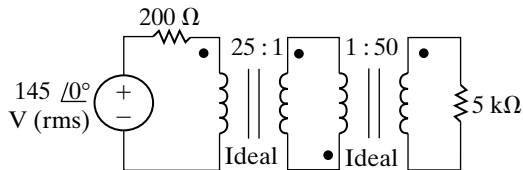
- Find the value of  $C$  in microfarads.
- When  $C$  has the value found in (a), what is the average power delivered to the 100 Ω resistor?
- Replace the 100 Ω resistor with a variable resistor  $R_o$ . Specify the value of  $R_o$  so that maximum average power is delivered to  $R_o$ .
- What is the maximum average power that can be delivered to  $R_o$ ?

Figure P10.60



**10.61** Find the average power delivered to the 5 kΩ resistor in the circuit of Fig. P10.61.

Figure P10.61



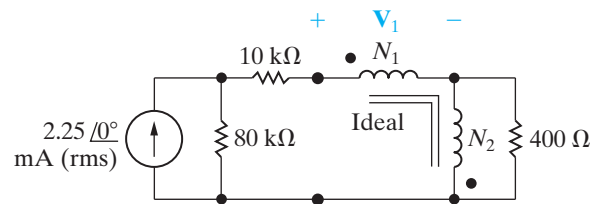
**10.62** The ideal transformer connected to the 5 kΩ load in Problem 10.61 is replaced with an ideal transformer that has a turns ratio of 1: $a$ .

- What value of  $a$  results in maximum average power being delivered to the 5 kΩ resistor?
- What is the maximum average power?

**10.63** a) Find the turns ratio  $N_1/N_2$  for the ideal transformer in the circuit in Fig. P10.63 so that maximum average power is delivered to the 400 Ω load.

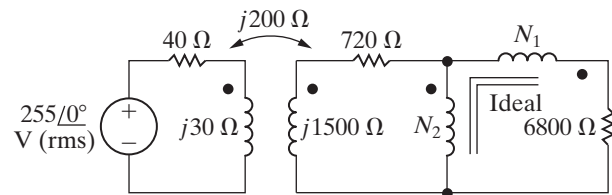
- Find the average power delivered to the 400 Ω load.
- Find the voltage  $V_1$ .
- What percentage of the power developed by the ideal current source is delivered to the 400 Ω resistor?

Figure P10.63



- 10.64** a) If  $N_1$  equals 1000 turns, how many turns should be placed on the  $N_2$  winding of the ideal transformer in the circuit seen in Fig. P10.64 so that maximum average power is delivered to the 6800 Ω load?
- Find the average power delivered to the 6800 Ω resistor.
  - What percentage of the average power delivered by the ideal voltage source is dissipated in the linear transformer?

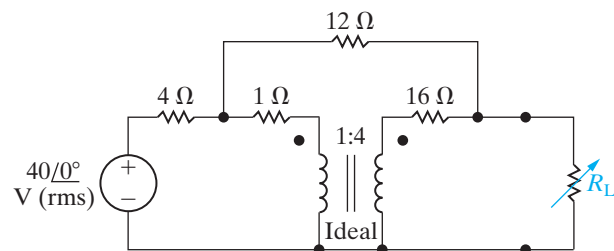
Figure P10.64



**10.65** The variable load resistor  $R_L$  in the circuit shown in Fig. P10.65 is adjusted for maximum average power transfer to  $R_L$ .

- Find the maximum average power.
- What percentage of the average power developed by the ideal voltage source is delivered to  $R_L$  when  $R_L$  is absorbing maximum average power?
- Test your solution by showing that the power developed by the ideal voltage source equals the power dissipated in the circuit.

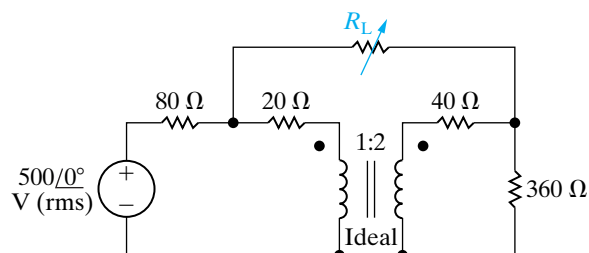
Figure P10.65



**10.66** Repeat Problem 10.65 for the circuit shown in Fig. P10.66.

PSPICE  
MULTISIM

Figure P10.66



### Sections 10.1–10.6

- 10.67** a) Use the values in Table 10.3 to calculate the number of kilowatt-hours consumed in one month by a notebook computer AC adapter if every day the computer is charging for 5 hours and sleeping for 19 hours.
- b) Repeat the calculation in part (a) assuming that the computer is charging for 5 hours and off for 19 hours.
- c) Repeat the calculation in part (a) assuming that the computer is charging for 5 hours and disconnected from the AC adapter for 19 hours, but the AC adapter remains plugged into the wall outlet.

- d) Repeat the calculation in part (a) assuming that the computer is charging for 5 hours and the AC adapter is unplugged from the wall outlet for 19 hours.

- 10.68** a) Suppose you use your microwave oven for 12 minutes each day. The remaining time, the oven is ready with the door closed. Use the values in Table 10.3 to calculate the total number of kilowatt-hours used by the microwave oven in one month.
- b) What percentage of the power used by the microwave oven in one month is consumed when the oven is ready with the door closed?
- 10.69** Determine the amount of power, in watts, consumed by the transformer in Fig. 10.29. Assume that the voltage source is ideal ( $R_s = 0 \Omega$ ),  $R_1 = 5 \Omega$ , and  $L_1 = 250 \text{ mH}$ . The frequency of the 120 V(rms) source is 60 Hz.
- 10.70** Repeat Problem 10.69, but assume that the linear transformer has been improved so that  $R_s = 50 \text{ m}\Omega$ . All other values are unchanged.
- 10.71** Repeat Problem 10.69 assuming that the linear transformer in Fig. 10.29 has been replaced by an ideal transformer with a turns ratio of 30:1. (*Hint* – you shouldn't need to make any calculations to determine the amount of power consumed.)

# CHAPTER 11

## CHAPTER CONTENTS

- 11.1 **Balanced Three-Phase Voltages** *p. 398*
- 11.2 **Three-Phase Voltage Sources** *p. 399*
- 11.3 **Analysis of the Wye-Wye Circuit** *p. 400*
- 11.4 **Analysis of the Wye-Delta Circuit** *p. 405*
- 11.5 **Power Calculations in Balanced Three-Phase Circuits** *p. 408*
- 11.6 **Measuring Average Power in Three-Phase Circuits** *p. 413*

## ✓ CHAPTER OBJECTIVES

- 1 Know how to analyze a balanced, three-phase wye-wye connected circuit.
- 2 Know how to analyze a balanced, three-phase wye-delta connected circuit.
- 3 Be able to calculate power (average, reactive, and complex) in any three-phase circuit.

# Balanced Three-Phase Circuits

**Generating, transmitting, distributing, and using** large blocks of electric power is accomplished with three-phase circuits. The comprehensive analysis of such systems is a field of study in its own right; we cannot hope to cover it in a single chapter. Fortunately, an understanding of only the steady-state sinusoidal behavior of balanced three-phase circuits is sufficient for engineers who do not specialize in power systems. We define what we mean by a balanced circuit later in the discussion. The same circuit analysis techniques discussed in earlier chapters can be applied to either unbalanced or balanced three-phase circuits. Here we use these familiar techniques to develop several shortcuts to the analysis of balanced three-phase circuits.

For economic reasons, three-phase systems are usually designed to operate in the balanced state. Thus, in this introductory treatment, we can justify considering only balanced circuits. The analysis of unbalanced three-phase circuits, which you will encounter if you study electric power in later courses, relies heavily on an understanding of balanced circuits.

The basic structure of a three-phase system consists of voltage sources connected to loads by means of transformers and transmission lines. To analyze such a circuit, we can reduce it to a voltage source connected to a load via a line. The omission of the transformer simplifies the discussion without jeopardizing a basic understanding of the calculations involved. Figure 11.1 on page 398 shows a basic circuit. A defining characteristic of a balanced three-phase circuit is that it contains a set of balanced three-phase voltages at its source. We begin by considering these voltages, and then we move to the voltage and current relationships for the Y-Y and Y- $\Delta$  circuits. After considering voltage and current in such circuits, we conclude with sections on power and power measurement.

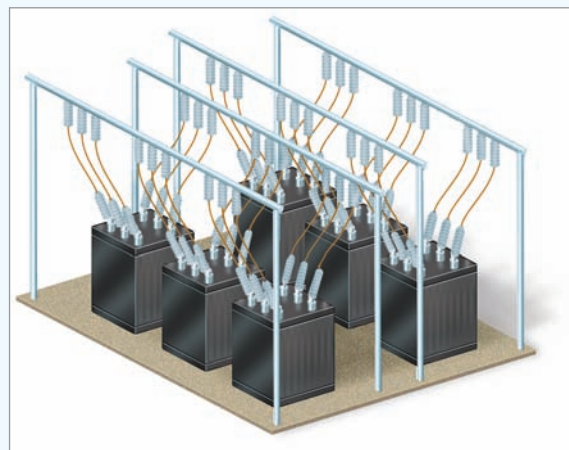
## Practical Perspective

### Transmission and Distribution of Electric Power

In this chapter we introduce circuits that are designed to handle large blocks of electric power. These are the circuits that are used to transport electric power from the generating plants to both industrial and residential customers. We introduced the typical residential customer circuit as used in the United States as the design perspective in Chapter 9. Now we introduce the type of circuit used to deliver electric power to an entire residential subdivision.

One of the constraints imposed on the design and operation of an electric utility is the requirement that the utility maintain the rms voltage level at the customer's premises. Whether lightly loaded, as at 3:00 am, or heavily loaded, as at midafternoon on a hot, humid day, the utility is obligated to supply the same rms voltage. Recall from Chapter 10 that a capacitor can be thought of as a source of magnetizing vars. Therefore, one technique for maintaining voltage levels on a utility system is to place capacitors at strategic locations in the distribution network. The idea behind this technique is to use the capacitors to supply magnetizing vars

close to the loads requiring them, as opposed to sending them over the lines from the generator. We shall illustrate this concept after we have introduced the analysis of balanced three-phase circuits.



Rolf Vennenbernd/dpa/Corbis

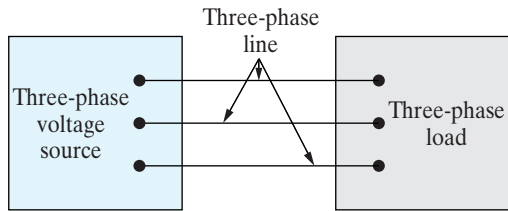


Figure 11.1 ▲ A basic three-phase circuit.

## 11.1 Balanced Three-Phase Voltages

A set of balanced three-phase voltages consists of three sinusoidal voltages that have identical amplitudes and frequencies but are out of phase with each other by exactly  $120^\circ$ . Standard practice is to refer to the three phases as a, b, and c, and to use the a-phase as the reference phase. The three voltages are referred to as the **a-phase voltage**, the **b-phase voltage**, and the **c-phase voltage**.

Only two possible phase relationships can exist between the a-phase voltage and the b- and c-phase voltages. One possibility is for the b-phase voltage to lag the a-phase voltage by  $120^\circ$ , in which case the c-phase voltage must lead the a-phase voltage by  $120^\circ$ . This phase relationship is known as the **abc** (or **positive**) **phase sequence**. The only other possibility is for the b-phase voltage to lead the a-phase voltage by  $120^\circ$ , in which case the c-phase voltage must lag the a-phase voltage by  $120^\circ$ . This phase relationship is known as the **acb** (or **negative**) **phase sequence**. In phasor notation, the two possible sets of balanced phase voltages are

$$\begin{aligned} \mathbf{V}_a &= V_m \angle 0^\circ, \\ \mathbf{V}_b &= V_m \angle -120^\circ, \\ \mathbf{V}_c &= V_m \angle +120^\circ, \end{aligned} \quad (11.1)$$

and

$$\begin{aligned} \mathbf{V}_a &= V_m \angle 0^\circ, \\ \mathbf{V}_b &= V_m \angle +120^\circ, \\ \mathbf{V}_c &= V_m \angle -120^\circ. \end{aligned} \quad (11.2)$$

Equations 11.1 are for the abc, or positive, sequence. Equations 11.2 are for the acb, or negative, sequence. Figure 11.2 shows the phasor diagrams of the voltage sets in Eqs. 11.1 and 11.2. The phase sequence is the clockwise order of the subscripts around the diagram from  $\mathbf{V}_a$ . The fact that a three-phase circuit can have one of two phase sequences must be taken into account whenever two such circuits operate in parallel. The circuits can operate in parallel only if they have the same phase sequence.

Another important characteristic of a set of balanced three-phase voltages is that the sum of the voltages is zero. Thus, from either Eqs. 11.1 or Eqs. 11.2,

$$\mathbf{V}_a + \mathbf{V}_b + \mathbf{V}_c = 0. \quad (11.3)$$

Because the sum of the phasor voltages is zero, the sum of the instantaneous voltages also is zero; that is,

$$v_a + v_b + v_c = 0. \quad (11.4)$$

Now that we know the nature of a balanced set of three-phase voltages, we can state the first of the analytical shortcuts alluded to in the introduction to this chapter: If we know the phase sequence and

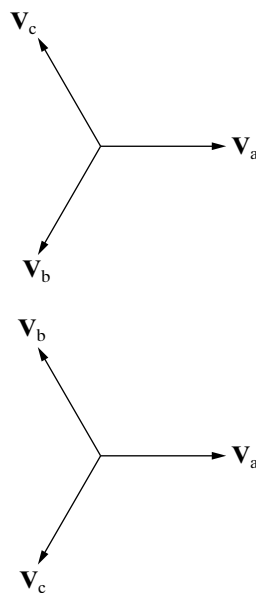


Figure 11.2 ▲ Phasor diagrams of a balanced set of three-phase voltages. (a) The abc (positive) sequence. (b) The acb (negative) sequence.



one voltage in the set, we know the entire set. Thus for a balanced three-phase system, we can focus on determining the voltage (or current) in one phase, because once we know one phase quantity, we know the others.

*NOTE:* Assess your understanding of three-phase voltages by trying Chapter Problems 11.1 and 11.2.

## 11.2 Three-Phase Voltage Sources

A three-phase voltage source is a generator with three separate windings distributed around the periphery of the stator. Each winding comprises one phase of the generator. The rotor of the generator is an electromagnet driven at synchronous speed by a prime mover, such as a steam or gas turbine. Rotation of the electromagnet induces a sinusoidal voltage in each winding. The phase windings are designed so that the sinusoidal voltages induced in them are equal in amplitude and out of phase with each other by  $120^\circ$ . The phase windings are stationary with respect to the rotating electromagnet, so the frequency of the voltage induced in each winding is the same. Figure 11.3 shows a sketch of a two-pole three-phase source.

There are two ways of interconnecting the separate phase windings to form a three-phase source: in either a wye (Y) or a delta ( $\Delta$ ) configuration. Figure 11.4 shows both, with ideal voltage sources used to model the phase windings of the three-phase generator. The common terminal in the Y-connected source, labeled  $n$  in Fig. 11.4(a), is called the **neutral terminal** of the source. The neutral terminal may or may not be available for external connections.

Sometimes, the impedance of each phase winding is so small (compared with other impedances in the circuit) that we need not account for it in modeling the generator; the model consists solely of ideal voltage sources, as in Fig. 11.4. However, if the impedance of each phase winding is not negligible, we place the winding impedance in series with an ideal sinusoidal voltage source. All windings on the machine are of the same construction, so we assume the winding impedances to be identical. The winding impedance of a three-phase generator is inductive. Figure 11.5 shows a model of such a machine, in which  $R_w$  is the winding resistance, and  $X_w$  is the inductive reactance of the winding.

Because three-phase sources and loads can be either Y-connected or  $\Delta$ -connected, the basic circuit in Fig. 11.1 represents four different configurations:

Source	Load
Y	Y
Y	$\Delta$
$\Delta$	Y
$\Delta$	$\Delta$

We begin by analyzing the Y-Y circuit. The remaining three arrangements can be reduced to a Y-Y equivalent circuit, so analysis of the Y-Y circuit is the key to solving all balanced three-phase arrangements. We then illustrate the reduction of the Y- $\Delta$  arrangement and leave the analysis of the  $\Delta$ -Y and  $\Delta$ - $\Delta$  arrangements to you in the Problems.

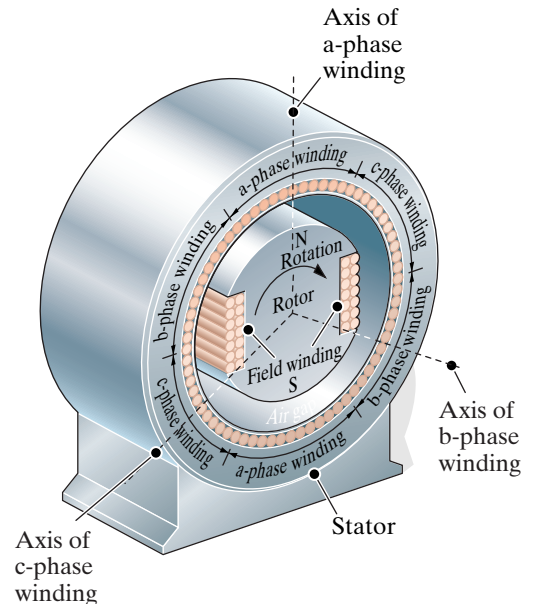


Figure 11.3 ▲ A sketch of a three-phase voltage source.

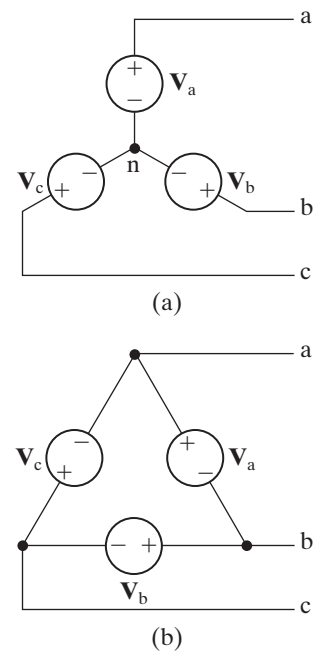
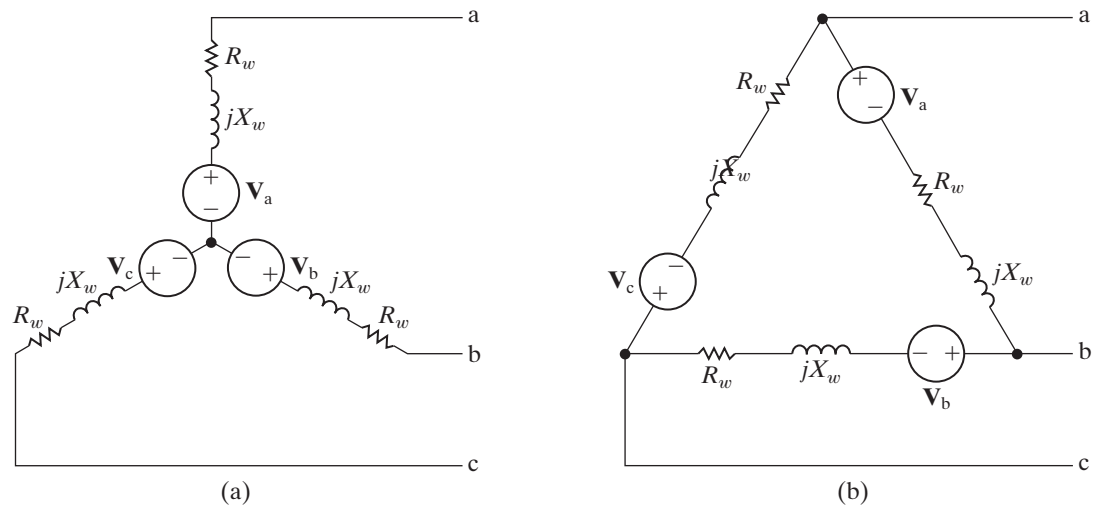


Figure 11.4 ▲ The two basic connections of an ideal three-phase source. (a) A Y-connected source. (b) A  $\Delta$ -connected source.



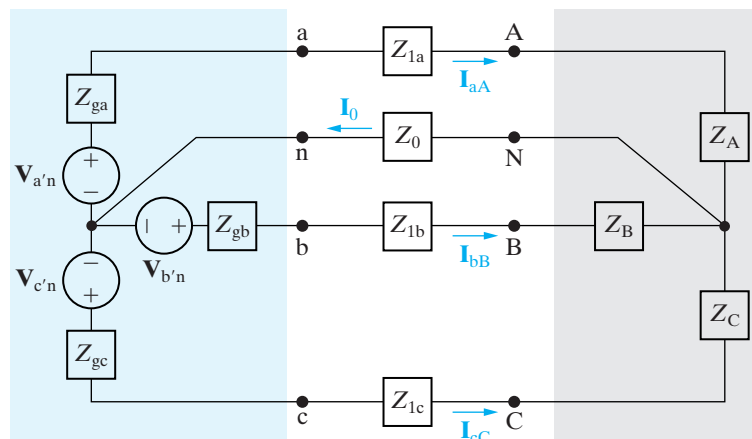
**Figure 11.5** ▲ A model of a three-phase source with winding impedance: (a) a Y-connected source; and (b) a Δ-connected source.

### 11.3 Analysis of the Wye-Wye Circuit

Figure 11.6 illustrates a general Y-Y circuit, in which we included a fourth conductor that connects the source neutral to the load neutral. A fourth conductor is possible only in the Y-Y arrangement. (More about this later.) For convenience, we transformed the Y connections into “tipped-over tees.” In Fig. 11.6,  $Z_{ga}$ ,  $Z_{gb}$ , and  $Z_{gc}$  represent the internal impedance associated with each phase winding of the voltage generator;  $Z_{1a}$ ,  $Z_{1b}$ , and  $Z_{1c}$  represent the impedance of the lines connecting a phase of the source to a phase of the load;  $Z_0$  is the impedance of the neutral conductor connecting the source neutral to the load neutral; and  $Z_A$ ,  $Z_B$ , and  $Z_C$  represent the impedance of each phase of the load.

We can describe this circuit with a single node-voltage equation. Using the source neutral as the reference node and letting  $V_N$  denote the node voltage between the nodes N and n, we find that the node-voltage equation is

$$\frac{V_N}{Z_0} + \frac{V_N - V_{a'n}}{Z_A + Z_{1a} + Z_{ga}} + \frac{V_N - V_{b'n}}{Z_B + Z_{1b} + Z_{gb}} + \frac{V_N - V_{c'n}}{Z_C + Z_{1c} + Z_{gc}} = 0. \tag{11.5}$$



**Figure 11.6** ▲ A three-phase Y-Y system.



This is the general equation for any circuit of the Y-Y configuration depicted in Fig. 11.6. But we can simplify Eq. 11.5 significantly if we now consider the formal definition of a balanced three-phase circuit. Such a circuit satisfies the following criteria:

1. The voltage sources form a set of balanced three-phase voltages. In Fig. 11.6, this means that  $\mathbf{V}_{a'n}$ ,  $\mathbf{V}_{b'n}$ , and  $\mathbf{V}_{c'n}$  are a set of balanced three-phase voltages.
2. The impedance of each phase of the voltage source is the same. In Fig. 11.6, this means that  $Z_{ga} = Z_{gb} = Z_{gc}$ .
3. The impedance of each line (or phase) conductor is the same. In Fig. 11.6, this means that  $Z_{1a} = Z_{1b} = Z_{1c}$ .
4. The impedance of each phase of the load is the same. In Fig. 11.6, this means that  $Z_A = Z_B = Z_C$ .

◀ **Conditions for a balanced three-phase circuit**

There is no restriction on the impedance of a neutral conductor; its value has no effect on whether the system is balanced.

If the circuit in Fig. 11.6 is balanced, we may rewrite Eq. 11.5 as

$$\mathbf{V}_N \left( \frac{1}{Z_0} + \frac{3}{Z_\phi} \right) = \frac{\mathbf{V}_{a'n} + \mathbf{V}_{b'n} + \mathbf{V}_{c'n}}{Z_\phi}, \quad (11.6)$$

where

$$Z_\phi = Z_A + Z_{1a} + Z_{ga} = Z_B + Z_{1b} + Z_{gb} = Z_C + Z_{1c} + Z_{gc}.$$

The right-hand side of Eq. 11.6 is zero, because by hypothesis the numerator is a set of balanced three-phase voltages and  $Z_\phi$  is not zero. The only value of  $\mathbf{V}_N$  that satisfies Eq. 11.6 is zero. Therefore, for a balanced three-phase circuit,

$$\mathbf{V}_N = 0. \quad (11.7)$$

Equation 11.7 is extremely important. If  $\mathbf{V}_N$  is zero, there is no difference in potential between the source neutral, n, and the load neutral, N; consequently, the current in the neutral conductor is zero. Hence we may either remove the neutral conductor from a balanced Y-Y configuration ( $\mathbf{I}_0 = 0$ ) or replace it with a perfect short circuit between the nodes n and N ( $\mathbf{V}_N = 0$ ). Both equivalents are convenient to use when modeling balanced three-phase circuits.

We now turn to the effect that balanced conditions have on the three line currents. With reference to Fig. 11.6, when the system is balanced, the three line currents are

$$\mathbf{I}_{aA} = \frac{\mathbf{V}_{a'n} - \mathbf{V}_N}{Z_A + Z_{1a} + Z_{ga}} = \frac{\mathbf{V}_{a'n}}{Z_\phi}, \quad (11.8)$$

$$\mathbf{I}_{bB} = \frac{\mathbf{V}_{b'n} - \mathbf{V}_N}{Z_B + Z_{1b} + Z_{gb}} = \frac{\mathbf{V}_{b'n}}{Z_\phi}, \quad (11.9)$$

$$\mathbf{I}_{cC} = \frac{\mathbf{V}_{c'n} - \mathbf{V}_N}{Z_C + Z_{1c} + Z_{gc}} = \frac{\mathbf{V}_{c'n}}{Z_\phi}. \quad (11.10)$$

We see that the three line currents form a balanced set of three-phase currents; that is, the current in each line is equal in amplitude and frequency and is  $120^\circ$  out of phase with the other two line currents. Thus, if we calculate the current  $\mathbf{I}_{aA}$  and we know the phase sequence, we have a shortcut

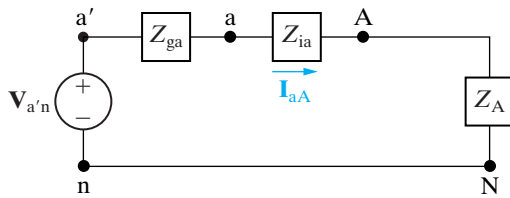


Figure 11.7 ▲ A single-phase equivalent circuit.

for finding  $I_{bB}$  and  $I_{cC}$ . This procedure parallels the shortcut used to find the b- and c-phase source voltages from the a-phase source voltage.

We can use Eq. 11.8 to construct an equivalent circuit for the a-phase of the balanced Y-Y circuit. From this equation, the current in the a-phase conductor line is simply the voltage generated in the a-phase winding of the generator divided by the total impedance in the a-phase of the circuit. Thus Eq. 11.8 describes the simple circuit shown in Fig. 11.7, in which the neutral conductor has been replaced by a perfect short circuit. The circuit in Fig. 11.7 is referred to as the **single-phase equivalent circuit** of a balanced three-phase circuit. Because of the established relationships between phases, once we solve this circuit, we can easily write down the voltages and currents in the other two phases. Thus, drawing a single-phase equivalent circuit is an important first step in analyzing a three-phase circuit.

A word of caution here. The current in the neutral conductor in Fig. 11.7 is  $I_{aA}$ , which is not the same as the current in the neutral conductor of the balanced three-phase circuit, which is

$$I_o = I_{aA} + I_{bB} + I_{cC}. \tag{11.11}$$

Thus the circuit shown in Fig. 11.7 gives the correct value of the line current but only the a-phase component of the neutral current. Whenever this single-phase equivalent circuit is applicable, the line currents form a balanced three-phase set, and the right-hand side of Eq. 11.11 sums to zero.

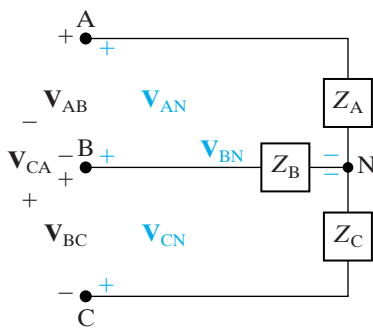


Figure 11.8 ▲ Line-to-line and line-to-neutral voltages.

Once we know the line current in Fig. 11.7, calculating any voltages of interest is relatively simple. Of particular interest is the relationship between the line-to-line voltages and the line-to-neutral voltages. We establish this relationship at the load terminals, but our observations also apply at the source terminals. The line-to-line voltages at the load terminals can be seen in Fig. 11.8. They are  $V_{AB}$ ,  $V_{BC}$ , and  $V_{CA}$ , where the double subscript notation indicates a voltage drop from the first-named node to the second. (Because we are interested in the balanced state, we have omitted the neutral conductor from Fig. 11.8.)

The line-to-neutral voltages are  $V_{AN}$ ,  $V_{BN}$ , and  $V_{CN}$ . We can now describe the line-to-line voltages in terms of the line-to-neutral voltages, using Kirchhoff's voltage law:

$$V_{AB} = V_{AN} - V_{BN}, \tag{11.12}$$

$$V_{BC} = V_{BN} - V_{CN}, \tag{11.13}$$

$$V_{CA} = V_{CN} - V_{AN}. \tag{11.14}$$

To show the relationship between the line-to-line voltages and the line-to-neutral voltages, we assume a positive, or abc, sequence. Using the line-to-neutral voltage of the a-phase as the reference,

$$V_{AN} = V_{\phi} \angle 0^{\circ}, \tag{11.15}$$

$$V_{BN} = V_{\phi} \angle -120^{\circ}, \tag{11.16}$$

$$V_{CN} = V_{\phi} \angle +120^{\circ}, \tag{11.17}$$

where  $V_\phi$  represents the magnitude of the line-to-neutral voltage. Substituting Eqs. 11.15–11.17 into Eqs. 11.12–11.14, respectively, yields

$$\mathbf{V}_{AB} = V_\phi \angle 0^\circ - V_\phi \angle -120^\circ = \sqrt{3}V_\phi \angle 30^\circ, \quad (11.18)$$

$$\mathbf{V}_{BC} = V_\phi \angle -120^\circ - V_\phi \angle 120^\circ = \sqrt{3}V_\phi \angle -90^\circ, \quad (11.19)$$

$$\mathbf{V}_{CA} = V_\phi \angle 120^\circ - V_\phi \angle 0^\circ = \sqrt{3}V_\phi \angle 150^\circ. \quad (11.20)$$

Equations 11.18–11.20 reveal that

1. The magnitude of the line-to-line voltage is  $\sqrt{3}$  times the magnitude of the line-to-neutral voltage.
2. The line-to-line voltages form a balanced three-phase set of voltages.
3. The set of line-to-line voltages leads the set of line-to-neutral voltages by  $30^\circ$ .

We leave to you the demonstration that for a negative sequence, the only change is that the set of line-to-line voltages lags the set of line-to-neutral voltages by  $30^\circ$ . The phasor diagrams shown in Fig. 11.9 summarize these observations. Here, again, is a shortcut in the analysis of a balanced system: If you know the line-to-neutral voltage at some point in the circuit, you can easily determine the line-to-line voltage at the same point and vice versa.

We now pause to elaborate on terminology. **Line voltage** refers to the voltage across any pair of lines; **phase voltage** refers to the voltage across a single phase. **Line current** refers to the current in a single line; **phase current** refers to current in a single phase. Observe that in a  $\Delta$  connection, line voltage and phase voltage are identical, and in a Y connection, line current and phase current are identical.

Because three-phase systems are designed to handle large blocks of electric power, all voltage and current specifications are given as rms values. When voltage ratings are given, they refer specifically to the rating of the line voltage. Thus when a three-phase transmission line is rated at 345 kV, the nominal value of the rms line-to-line voltage is 345,000 V. In this chapter we express all voltages and currents as rms values.

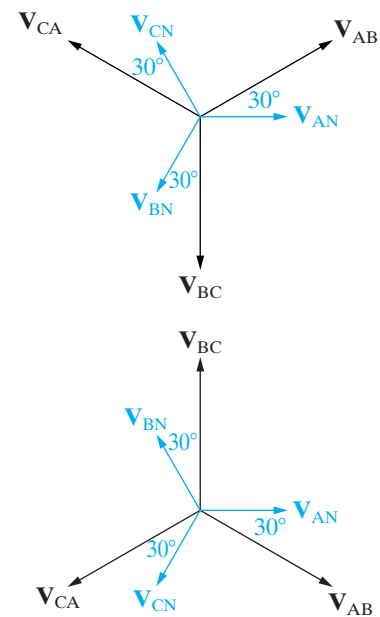
Finally, the Greek letter phi ( $\phi$ ) is widely used in the literature to denote a per-phase quantity. Thus  $\mathbf{V}_\phi$ ,  $\mathbf{I}_\phi$ ,  $Z_\phi$ ,  $P_\phi$ , and  $Q_\phi$  are interpreted as voltage/phase, current/phase, impedance/phase, power/phase, and reactive power/phase, respectively.

Example 11.1 shows how to use the observations made so far to solve a balanced three-phase Y-Y circuit.

### Example 11.1 Analyzing a Wye-Wye Circuit

A balanced three-phase Y-connected generator with positive sequence has an impedance of  $0.2 + j0.5 \Omega/\phi$  and an internal voltage of  $120 \text{ V}/\phi$ . The generator feeds a balanced three-phase Y-connected load having an impedance of  $39 + j28 \Omega/\phi$ . The impedance of the line connecting the generator to the load is  $0.8 + j1.5 \Omega/\phi$ . The a-phase internal voltage of the generator is specified as the reference phasor.

- a) Construct the a-phase equivalent circuit of the system.
- b) Calculate the three line currents  $\mathbf{I}_{aA}$ ,  $\mathbf{I}_{bB}$ , and  $\mathbf{I}_{cC}$ .
- c) Calculate the three phase voltages at the load,  $\mathbf{V}_{AN}$ ,  $\mathbf{V}_{BN}$ , and  $\mathbf{V}_{CN}$ .
- d) Calculate the line voltages  $\mathbf{V}_{AB}$ ,  $\mathbf{V}_{BC}$ , and  $\mathbf{V}_{CA}$  at the terminals of the load.



**Figure 11.9** ▲ Phasor diagrams showing the relationship between line-to-line and line-to-neutral voltages in a balanced system. (a) The abc sequence. (b) The acb sequence.

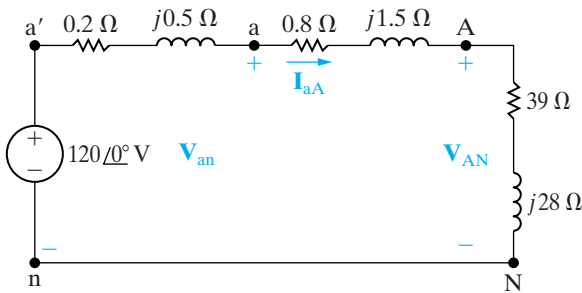
- e) Calculate the phase voltages at the terminals of the generator,  $V_{an}$ ,  $V_{bn}$ , and  $V_{cn}$ .
- f) Calculate the line voltages  $V_{ab}$ ,  $V_{bc}$ , and  $V_{ca}$  at the terminals of the generator.
- g) Repeat (a)–(f) for a negative phase sequence.

**Solution**

a) Figure 11.10 shows the single-phase equivalent circuit.

b) The a-phase line current is

$$\begin{aligned} I_{aA} &= \frac{120 \angle 0^\circ}{(0.2 + 0.8 + 39) + j(0.5 + 1.5 + 28)} \\ &= \frac{120 \angle 0^\circ}{40 + j30} \\ &= 2.4 \angle -36.87^\circ \text{ A.} \end{aligned}$$



**Figure 11.10** ▲ The single-phase equivalent circuit for Example 11.1.

For a positive phase sequence,

$$\begin{aligned} I_{bB} &= 2.4 \angle -156.87^\circ \text{ A,} \\ I_{cC} &= 2.4 \angle 83.13^\circ \text{ A.} \end{aligned}$$

c) The phase voltage at the A terminal of the load is

$$\begin{aligned} V_{AN} &= (39 + j28)(2.4 \angle -36.87^\circ) \\ &= 115.22 \angle -1.19^\circ \text{ V.} \end{aligned}$$

For a positive phase sequence,

$$\begin{aligned} V_{BN} &= 115.22 \angle -121.19^\circ \text{ V,} \\ V_{CN} &= 115.22 \angle 118.81^\circ \text{ V.} \end{aligned}$$

d) For a positive phase sequence, the line voltages lead the phase voltages by 30°; thus

$$\begin{aligned} V_{AB} &= (\sqrt{3} \angle 30^\circ) V_{AN} \\ &= 199.58 \angle 28.81^\circ \text{ V,} \\ V_{BC} &= 199.58 \angle -91.19^\circ \text{ V,} \\ V_{CA} &= 199.58 \angle 148.81^\circ \text{ V.} \end{aligned}$$

e) The phase voltage at the a terminal of the source is

$$\begin{aligned} V_{an} &= 120 - (0.2 + j0.5)(2.4 \angle -36.87^\circ) \\ &= 120 - 1.29 \angle 31.33^\circ \\ &= 118.90 - j0.67 \\ &= 118.90 \angle -0.32^\circ \text{ V.} \end{aligned}$$

For a positive phase sequence,

$$\begin{aligned} V_{bn} &= 118.90 \angle -120.32^\circ \text{ V,} \\ V_{cn} &= 118.90 \angle 119.68^\circ \text{ V.} \end{aligned}$$

f) The line voltages at the source terminals are

$$\begin{aligned} V_{ab} &= (\sqrt{3} \angle 30^\circ) V_{an} \\ &= 205.94 \angle 29.68^\circ \text{ V,} \\ V_{bc} &= 205.94 \angle -90.32^\circ \text{ V,} \\ V_{ca} &= 205.94 \angle 149.68^\circ \text{ V.} \end{aligned}$$

g) Changing the phase sequence has no effect on the single-phase equivalent circuit. The three line currents are

$$\begin{aligned} I_{aA} &= 2.4 \angle -36.87^\circ \text{ A,} \\ I_{bB} &= 2.4 \angle 83.13^\circ \text{ A,} \\ I_{cC} &= 2.4 \angle -156.87^\circ \text{ A.} \end{aligned}$$

The phase voltages at the load are

$$\begin{aligned} V_{AN} &= 115.22 \angle -1.19^\circ \text{ V,} \\ V_{BN} &= 115.22 \angle 118.81^\circ \text{ V,} \\ V_{CN} &= 115.22 \angle -121.19^\circ \text{ V.} \end{aligned}$$

For a negative phase sequence, the line voltages lag the phase voltages by 30°:

$$\begin{aligned} V_{AB} &= (\sqrt{3} \angle -30^\circ) V_{AN} \\ &= 199.58 \angle -31.19^\circ \text{ V,} \\ V_{BC} &= 199.58 \angle 88.81^\circ \text{ V,} \\ V_{CA} &= 199.58 \angle -151.19^\circ \text{ V.} \end{aligned}$$

The phase voltages at the terminals of the generator are

$$\begin{aligned} V_{an} &= 118.90 \angle -0.32^\circ \text{ V,} \\ V_{bn} &= 118.90 \angle 119.68^\circ \text{ V,} \\ V_{cn} &= 118.90 \angle -120.32^\circ \text{ V.} \end{aligned}$$

The line voltages at the terminals of the generator are

$$\begin{aligned} V_{ab} &= (\sqrt{3} \angle -30^\circ) V_{an} \\ &= 205.94 \angle -30.32^\circ \text{ V,} \\ V_{bc} &= 205.94 \angle 89.68^\circ \text{ V,} \\ V_{ca} &= 205.94 \angle -150.32^\circ \text{ V.} \end{aligned}$$

## ASSESSMENT PROBLEMS

### Objective 1—Know how to analyze a balanced, three-phase wye-wye circuit

**11.1** The voltage from A to N in a balanced three-phase circuit is  $240 \angle -30^\circ$  V. If the phase sequence is positive, what is the value of  $\mathbf{V}_{BC}$ ?

**Answer:**  $415.69 \angle -120^\circ$  V.

**11.2** The c-phase voltage of a balanced three-phase Y-connected system is  $450 \angle -25^\circ$  V. If the phase sequence is negative, what is the value of  $\mathbf{V}_{AB}$ ?

**Answer:**  $779.42 \angle 65^\circ$  V.

**11.3** The phase voltage at the terminals of a balanced three-phase Y-connected load is 2400 V. The load has an impedance of  $16 + j12 \Omega/\phi$  and is fed from a line having an impedance of  $0.10 + j0.80 \Omega/\phi$ . The Y-connected source at the sending end of the line has a phase

sequence of acb and an internal impedance of  $0.02 + j0.16 \Omega/\phi$ . Use the a-phase voltage at the load as the reference and calculate (a) the line currents  $\mathbf{I}_{aA}$ ,  $\mathbf{I}_{bB}$ , and  $\mathbf{I}_{cC}$ ; (b) the line voltages at the source,  $\mathbf{V}_{ab}$ ,  $\mathbf{V}_{bc}$ , and  $\mathbf{V}_{ca}$ ; and (c) the internal phase-to-neutral voltages at the source,  $\mathbf{V}_{a'n}$ ,  $\mathbf{V}_{b'n}$ , and  $\mathbf{V}_{c'n}$ .

**Answer:** (a)  $\mathbf{I}_{aA} = 120 \angle -36.87^\circ$  A,  
 $\mathbf{I}_{bB} = 120 \angle 83.13^\circ$  A, and  
 $\mathbf{I}_{cC} = 120 \angle -156.87^\circ$  A;  
 (b)  $\mathbf{V}_{ab} = 4275.02 \angle -28.38^\circ$  V,  
 $\mathbf{V}_{bc} = 4275.02 \angle 91.62^\circ$  V, and  
 $\mathbf{V}_{ca} = 4275.02 \angle -148.38^\circ$  V;  
 (c)  $\mathbf{V}_{a'n} = 2482.05 \angle 1.93^\circ$  V,  
 $\mathbf{V}_{b'n} = 2482.05 \angle 121.93^\circ$  V, and  
 $\mathbf{V}_{c'n} = 2482.05 \angle -118.07^\circ$  V.

*NOTE:* Also try Chapter Problems 11.9, 11.11, and 11.12.

## 11.4 Analysis of the Wye-Delta Circuit

If the load in a three-phase circuit is connected in a delta, it can be transformed into a wye by using the delta-to-wye transformation discussed in Section 9.6. When the load is balanced, the impedance of each leg of the wye is one third the impedance of each leg of the delta, or

$$Z_Y = \frac{Z_\Delta}{3}, \quad (11.21)$$

which follows directly from Eqs. 9.51–9.53. After the  $\Delta$  load has been replaced by its Y equivalent, the a-phase can be modeled by the single-phase equivalent circuit shown in Fig. 11.11.

We use this circuit to calculate the line currents, and we then use the line currents to find the currents in each leg of the original  $\Delta$  load. The relationship between the line currents and the currents in each leg of the delta can be derived using the circuit shown in Fig. 11.12.

When a load (or source) is connected in a delta, the current in each leg of the delta is the phase current, and the voltage across each leg is the phase voltage. Figure 11.12 shows that, in the  $\Delta$  configuration, the phase voltage is identical to the line voltage.

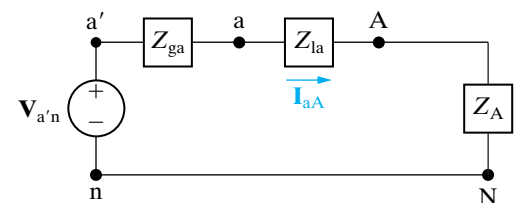
To demonstrate the relationship between the phase currents and line currents, we assume a positive phase sequence and let  $I_\phi$  represent the magnitude of the phase current. Then

$$\mathbf{I}_{AB} = I_\phi \angle 0^\circ, \quad (11.22)$$

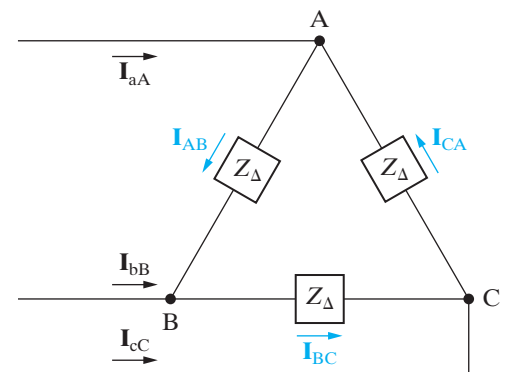
$$\mathbf{I}_{BC} = I_\phi \angle -120^\circ, \quad (11.23)$$

$$\mathbf{I}_{CA} = I_\phi \angle 120^\circ. \quad (11.24)$$

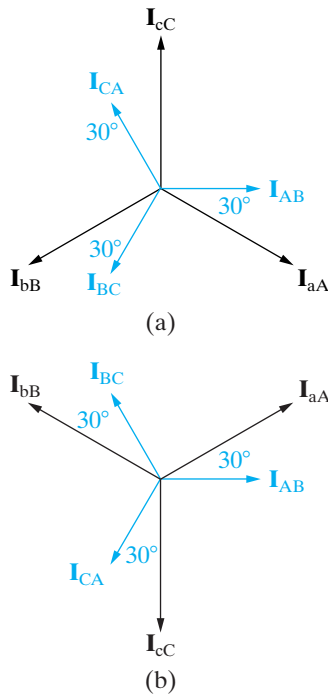
### Relationship between three-phase delta-connected and wye-connected impedance



**Figure 11.11** ▲ A single-phase equivalent circuit.



**Figure 11.12** ▲ A circuit used to establish the relationship between line currents and phase currents in a balanced  $\Delta$  load.



**Figure 11.13** ▲ Phasor diagrams showing the relationship between line currents and phase currents in a Δ-connected load. (a) The positive sequence. (b) The negative sequence.

In writing these equations, we arbitrarily selected  $I_{AB}$  as the reference phasor.

We can write the line currents in terms of the phase currents by direct application of Kirchhoff's current law:

$$\begin{aligned} I_{aA} &= I_{AB} - I_{CA} \\ &= I_\phi \angle 0^\circ - I_\phi \angle 120^\circ \\ &= \sqrt{3}I_\phi \angle -30^\circ, \end{aligned} \tag{11.25}$$

$$\begin{aligned} I_{bB} &= I_{BC} - I_{AB} \\ &= I_\phi \angle -120^\circ - I_\phi \angle 0^\circ \\ &= \sqrt{3}I_\phi \angle -150^\circ, \end{aligned} \tag{11.26}$$

$$\begin{aligned} I_{cC} &= I_{CA} - I_{BC} \\ &= I_\phi \angle 120^\circ - I_\phi \angle -120^\circ \\ &= \sqrt{3}I_\phi \angle 90^\circ. \end{aligned} \tag{11.27}$$

Comparing Eqs. 11.25–11.27 with Eqs. 11.22–11.24 reveals that the magnitude of the line currents is  $\sqrt{3}$  times the magnitude of the phase currents and that the set of line currents lags the set of phase currents by  $30^\circ$ .

We leave to you to verify that, for a negative phase sequence, the line currents are  $\sqrt{3}$  times larger than the phase currents and lead the phase currents by  $30^\circ$ . Thus, we have a shortcut for calculating line currents from phase currents (or vice versa) for a balanced three-phase Δ-connected load. Figure 11.13 summarizes this shortcut graphically. Example 11.2 illustrates the calculations involved in analyzing a balanced three-phase circuit having a Y-connected source and a Δ-connected load.

**Example 11.2 Analyzing a Wye-Delta Circuit**

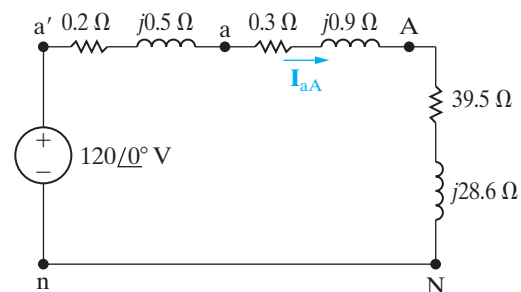
The Y-connected source in Example 11.1 feeds a Δ-connected load through a distribution line having an impedance of  $0.3 + j0.9 \Omega/\phi$ . The load impedance is  $118.5 + j85.8 \Omega/\phi$ . Use the a-phase internal voltage of the generator as the reference.

- Construct a single-phase equivalent circuit of the three-phase system.
- Calculate the line currents  $I_{aA}$ ,  $I_{bB}$ , and  $I_{cC}$ .
- Calculate the phase voltages at the load terminals.
- Calculate the phase currents of the load.
- Calculate the line voltages at the source terminals.

**Solution**

a) Figure 11.14 shows the single-phase equivalent circuit. The load impedance of the Y equivalent is

$$\frac{118.5 + j85.8}{3} = 39.5 + j28.6 \Omega/\phi.$$



**Figure 11.14** ▲ The single-phase equivalent circuit for Example 11.2.

b) The a-phase line current is

$$\begin{aligned} I_{aA} &= \frac{120 \angle 0^\circ}{(0.2 + 0.3 + 39.5) + j(0.5 + 0.9 + 28.6)} \\ &= \frac{120 \angle 0^\circ}{40 + j30} = 2.4 \angle -36.87^\circ \text{ A.} \end{aligned}$$

Hence

$$\mathbf{I}_{bB} = 2.4 \angle -156.87^\circ \text{ A},$$

$$\mathbf{I}_{cC} = 2.4 \angle 83.13^\circ \text{ A}.$$

- c) Because the load is  $\Delta$  connected, the phase voltages are the same as the line voltages. To calculate the line voltages, we first calculate  $\mathbf{V}_{AN}$ :

$$\begin{aligned}\mathbf{V}_{AN} &= (39.5 + j28.6)(2.4 \angle -36.87^\circ) \\ &= 117.04 \angle -0.96^\circ \text{ V}.\end{aligned}$$

Because the phase sequence is positive, the line voltage  $\mathbf{V}_{AB}$  is

$$\begin{aligned}\mathbf{V}_{AB} &= (\sqrt{3} \angle 30^\circ) \mathbf{V}_{AN} \\ &= 202.72 \angle 29.04^\circ \text{ V}.\end{aligned}$$

Therefore

$$\mathbf{V}_{BC} = 202.72 \angle -90.96^\circ \text{ V},$$

$$\mathbf{V}_{CA} = 202.72 \angle 149.04^\circ \text{ V}.$$

- d) The phase currents of the load may be calculated directly from the line currents:

$$\begin{aligned}\mathbf{I}_{AB} &= \left( \frac{1}{\sqrt{3}} \angle 30^\circ \right) \mathbf{I}_{aA} \\ &= 1.39 \angle -6.87^\circ \text{ A}.\end{aligned}$$

Once we know  $\mathbf{I}_{AB}$ , we also know the other load phase currents:

$$\mathbf{I}_{BC} = 1.39 \angle -126.87^\circ \text{ A},$$

$$\mathbf{I}_{CA} = 1.39 \angle 113.13^\circ \text{ A}.$$

Note that we can check the calculation of  $\mathbf{I}_{AB}$  by using the previously calculated  $\mathbf{V}_{AB}$  and the impedance of the  $\Delta$ -connected load; that is,

$$\begin{aligned}\mathbf{I}_{AB} &= \frac{\mathbf{V}_{AB}}{Z_\phi} = \frac{202.72 \angle 29.04^\circ}{118.5 + j85.8} \\ &= 1.39 \angle -6.87^\circ \text{ A}.\end{aligned}$$

- e) To calculate the line voltage at the terminals of the source, we first calculate  $\mathbf{V}_{an}$ . Figure 11.14 shows that  $\mathbf{V}_{an}$  is the voltage drop across the line impedance plus the load impedance, so

$$\begin{aligned}\mathbf{V}_{an} &= (39.8 + j29.5)(2.4 \angle -36.87^\circ) \\ &= 118.90 \angle -0.32^\circ \text{ V}.\end{aligned}$$

The line voltage  $\mathbf{V}_{ab}$  is

$$\mathbf{V}_{ab} = (\sqrt{3} \angle 30^\circ) \mathbf{V}_{an},$$

or

$$\mathbf{V}_{ab} = 205.94 \angle 29.68^\circ \text{ V}.$$

Therefore

$$\mathbf{V}_{bc} = 205.94 \angle -90.32^\circ \text{ V},$$

$$\mathbf{V}_{ca} = 205.94 \angle 149.68^\circ \text{ V}.$$

## ✓ ASSESSMENT PROBLEMS

### Objective 2—Know how to analyze a balanced, three-phase wye-delta connected circuit

- 11.4** The current  $\mathbf{I}_{CA}$  in a balanced three-phase  $\Delta$ -connected load is  $8 \angle -15^\circ$  A. If the phase sequence is positive, what is the value of  $\mathbf{I}_{cC}$ ?

**Answer:**  $13.86 \angle -45^\circ$  A.

- 11.5** A balanced three-phase  $\Delta$ -connected load is fed from a balanced three-phase circuit. The reference for the b-phase line current is toward the load. The value of the current in the b-phase is  $12 \angle 65^\circ$  A. If the phase sequence is negative, what is the value of  $\mathbf{I}_{AB}$ ?

**Answer:**  $6.93 \angle -85^\circ$  A.

**NOTE:** Also try Chapter Problems 11.14–11.16.

- 11.6** The line voltage  $\mathbf{V}_{AB}$  at the terminals of a balanced three-phase  $\Delta$ -connected load is  $4160 \angle 0^\circ$  V. The line current  $\mathbf{I}_{aA}$  is  $69.28 \angle -10^\circ$  A.

- Calculate the per-phase impedance of the load if the phase sequence is positive.
- Repeat (a) for a negative phase sequence.

**Answer:** (a)  $104 \angle -20^\circ \Omega$ ;  
(b)  $104 \angle +40^\circ \Omega$ .

- 11.7** The line voltage at the terminals of a balanced  $\Delta$ -connected load is 110 V. Each phase of the load consists of a  $3.667 \Omega$  resistor in parallel with a  $2.75 \Omega$  inductive impedance. What is the magnitude of the current in the line feeding the load?

**Answer:** 86.60 A.



## 11.5 Power Calculations in Balanced Three-Phase Circuits

So far, we have limited our analysis of balanced three-phase circuits to determining currents and voltages. We now discuss three-phase power calculations. We begin by considering the average power delivered to a balanced Y-connected load.

### Average Power in a Balanced Wye Load

Figure 11.15 shows a Y-connected load, along with its pertinent currents and voltages. We calculate the average power associated with any one phase by using the techniques introduced in Chapter 10. With Eq. 10.21 as a starting point, we express the average power associated with the a-phase as

$$P_A = |\mathbf{V}_{AN}| |\mathbf{I}_{aA}| \cos(\theta_{vA} - \theta_{iA}), \quad (11.28)$$

where  $\theta_{vA}$  and  $\theta_{iA}$  denote the phase angles of  $\mathbf{V}_{AN}$  and  $\mathbf{I}_{aA}$ , respectively. Using the notation introduced in Eq. 11.28, we can find the power associated with the b- and c-phases:

$$P_B = |\mathbf{V}_{BN}| |\mathbf{I}_{bB}| \cos(\theta_{vB} - \theta_{iB}), \quad (11.29)$$

$$P_C = |\mathbf{V}_{CN}| |\mathbf{I}_{cC}| \cos(\theta_{vC} - \theta_{iC}). \quad (11.30)$$

In Eqs. 11.28–11.30, all phasor currents and voltages are written in terms of the rms value of the sinusoidal function they represent.

In a balanced three-phase system, the magnitude of each line-to-neutral voltage is the same, as is the magnitude of each phase current. The argument of the cosine functions is also the same for all three phases. We emphasize these observations by introducing the following notation:

$$V_\phi = |\mathbf{V}_{AN}| = |\mathbf{V}_{BN}| = |\mathbf{V}_{CN}|, \quad (11.31)$$

$$I_\phi = |\mathbf{I}_{aA}| = |\mathbf{I}_{bB}| = |\mathbf{I}_{cC}|, \quad (11.32)$$

and

$$\theta_\phi = \theta_{vA} - \theta_{iA} = \theta_{vB} - \theta_{iB} = \theta_{vC} - \theta_{iC}. \quad (11.33)$$

Moreover, for a balanced system, the power delivered to each phase of the load is the same, so

$$P_A = P_B = P_C = P_\phi = V_\phi I_\phi \cos \theta_\phi, \quad (11.34)$$

where  $P_\phi$  represents the average power per phase.

The total average power delivered to the balanced Y-connected load is simply three times the power per phase, or

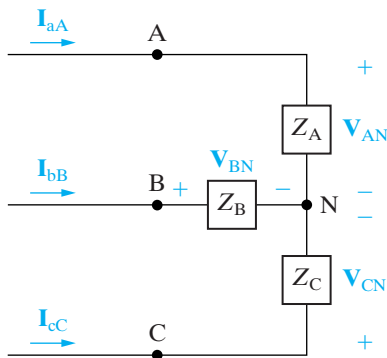
$$P_T = 3P_\phi = 3V_\phi I_\phi \cos \theta_\phi. \quad (11.35)$$

Expressing the total power in terms of the rms magnitudes of the line voltage and current is also desirable. If we let  $V_L$  and  $I_L$  represent the rms magnitudes of the line voltage and current, respectively, we can modify Eq. 11.35 as follows:

**Total real power in a balanced three-phase load ►**

$$P_T = 3 \left( \frac{V_L}{\sqrt{3}} \right) I_L \cos \theta_\phi$$

$$= \sqrt{3} V_L I_L \cos \theta_\phi. \quad (11.36)$$



**Figure 11.15** ▲ A balanced Y load used to introduce average power calculations in three-phase circuits.

In deriving Eq. 11.36, we recognized that, for a balanced Y-connected load, the magnitude of the phase voltage is the magnitude of the line voltage divided by  $\sqrt{3}$ , and that the magnitude of the line current is equal to the magnitude of the phase current. When using Eq. 11.36 to calculate the total power delivered to the load, remember that  $\theta_\phi$  is the phase angle between the phase voltage and current.

### Complex Power in a Balanced Wye Load

We can also calculate the reactive power and complex power associated with any one phase of a Y-connected load by using the techniques introduced in Chapter 10. For a balanced load, the expressions for the reactive power are

$$Q_\phi = V_\phi I_\phi \sin \theta_\phi, \quad (11.37)$$

$$Q_T = 3Q_\phi = \sqrt{3}V_L I_L \sin \theta_\phi. \quad (11.38)$$

Equation 10.29 is the basis for expressing the complex power associated with any phase. For a balanced load,

$$S_\phi = \mathbf{V}_{AN}\mathbf{I}_{aA}^* = \mathbf{V}_{BN}\mathbf{I}_{bB}^* = \mathbf{V}_{CN}\mathbf{I}_{cC}^* = \mathbf{V}_\phi\mathbf{I}_\phi^*, \quad (11.39)$$

where  $\mathbf{V}_\phi$  and  $\mathbf{I}_\phi$  represent a phase voltage and current taken from the same phase. Thus, in general,

$$S_\phi = P_\phi + jQ_\phi = \mathbf{V}_\phi\mathbf{I}_\phi^*, \quad (11.40)$$

$$S_T = 3S_\phi = \sqrt{3}V_L I_L \angle \theta_\phi^*. \quad (11.41)$$

◀ Total reactive power in a balanced three-phase load

◀ Total complex power in a balanced three-phase load

### Power Calculations in a Balanced Delta Load

If the load is  $\Delta$ -connected, the calculation of power—reactive or complex—is basically the same as that for a Y-connected load. Figure 11.16 shows a  $\Delta$ -connected load, along with its pertinent currents and voltages. The power associated with each phase is

$$P_A = |\mathbf{V}_{AB}||\mathbf{I}_{AB}| \cos(\theta_{v_{AB}} - \theta_{i_{AB}}), \quad (11.42)$$

$$P_B = |\mathbf{V}_{BC}||\mathbf{I}_{BC}| \cos(\theta_{v_{BC}} - \theta_{i_{BC}}), \quad (11.43)$$

$$P_C = |\mathbf{V}_{CA}||\mathbf{I}_{CA}| \cos(\theta_{v_{CA}} - \theta_{i_{CA}}). \quad (11.44)$$

For a balanced load,

$$|\mathbf{V}_{AB}| = |\mathbf{V}_{BC}| = |\mathbf{V}_{CA}| = V_\phi, \quad (11.45)$$

$$|\mathbf{I}_{AB}| = |\mathbf{I}_{BC}| = |\mathbf{I}_{CA}| = I_\phi, \quad (11.46)$$

$$\theta_{v_{AB}} - \theta_{i_{AB}} = \theta_{v_{BC}} - \theta_{i_{BC}} = \theta_{v_{CA}} - \theta_{i_{CA}} = \theta_\phi, \quad (11.47)$$

and

$$P_A = P_B = P_C = P_\phi = V_\phi I_\phi \cos \theta_\phi. \quad (11.48)$$

Note that Eq. 11.48 is the same as Eq. 11.34. Thus, in a balanced load, regardless of whether it is Y- or  $\Delta$ -connected, the average power per phase is equal to the product of the rms magnitude of the phase voltage, the rms magnitude of the phase current, and the cosine of the angle between the phase voltage and current.

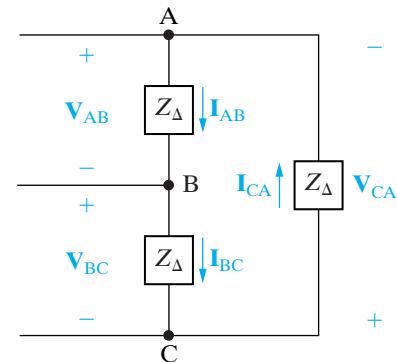


Figure 11.16 ▲ A  $\Delta$ -connected load used to discuss power calculations.

The total power delivered to a balanced  $\Delta$ -connected load is

$$\begin{aligned} P_T &= 3P_\phi = 3V_\phi I_\phi \cos \theta_\phi \\ &= 3V_L \left( \frac{I_L}{\sqrt{3}} \right) \cos \theta_\phi \\ &= \sqrt{3}V_L I_L \cos \theta_\phi. \end{aligned} \quad (11.49)$$

Note that Eq. 11.49 is the same as Eq. 11.36. The expressions for reactive power and complex power also have the same form as those developed for the Y load:

$$Q_\phi = V_\phi I_\phi \sin \theta_\phi; \quad (11.50)$$

$$Q_T = 3Q_\phi = 3V_\phi I_\phi \sin \theta_\phi; \quad (11.51)$$

$$S_\phi = P_\phi + jQ_\phi = \mathbf{V}_\phi \mathbf{I}_\phi^*; \quad (11.52)$$

$$S_T = 3S_\phi = \sqrt{3}V_L I_L \angle \theta_\phi. \quad (11.53)$$

### Instantaneous Power in Three-Phase Circuits

Although we are primarily interested in average, reactive, and complex power calculations, the computation of the total instantaneous power is also important. In a balanced three-phase circuit, this power has an interesting property: It is invariant with time! Thus the torque developed at the shaft of a three-phase motor is constant, which in turn means less vibration in machinery powered by three-phase motors.

Let the instantaneous line-to-neutral voltage  $v_{AN}$  be the reference, and, as before,  $\theta_\phi$  is the phase angle  $\theta_{v_A} - \theta_{i_A}$ . Then, for a positive phase sequence, the instantaneous power in each phase is

$$p_A = v_{AN}i_{aA} = V_m I_m \cos \omega t \cos(\omega t - \theta_\phi),$$

$$p_B = v_{BN}i_{bB} = V_m I_m \cos(\omega t - 120^\circ) \cos(\omega t - \theta_\phi - 120^\circ),$$

$$p_C = v_{CN}i_{cC} = V_m I_m \cos(\omega t + 120^\circ) \cos(\omega t - \theta_\phi + 120^\circ),$$

where  $V_m$  and  $I_m$  represent the maximum amplitude of the phase voltage and line current, respectively. The total instantaneous power is the sum of the instantaneous phase powers, which reduces to  $1.5V_m I_m \cos \theta_\phi$ ; that is,

$$p_T = p_A + p_B + p_C = 1.5V_m I_m \cos \theta_\phi.$$

Note this result is consistent with Eq. 11.35 since  $V_m = \sqrt{2}V_\phi$  and  $I_m = \sqrt{2}I_\phi$  (see Problem 11.26).

Examples 11.3–11.5 illustrate power calculations in balanced three-phase circuits.

**Example 11.3** Calculating Power in a Three-Phase Wye-Wye Circuit

- Calculate the average power per phase delivered to the Y-connected load of Example 11.1.
- Calculate the total average power delivered to the load.
- Calculate the total average power lost in the line.
- Calculate the total average power lost in the generator.
- Calculate the total number of magnetizing vars absorbed by the load.
- Calculate the total complex power delivered by the source.

**Solution**

- a) From Example 11.1,  $V_\phi = 115.22$  V,  $I_\phi = 2.4$  A, and  $\theta_\phi = -1.19 - (-36.87) = 35.68^\circ$ . Therefore

$$\begin{aligned} P_\phi &= (115.22)(2.4) \cos 35.68^\circ \\ &= 224.64 \text{ W.} \end{aligned}$$

The power per phase may also be calculated from  $I_\phi^2 R_\phi$ , or

$$P_\phi = (2.4)^2(39) = 224.64 \text{ W.}$$

- b) The total average power delivered to the load is  $P_T = 3P_\phi = 673.92$  W. We calculated the line voltage in Example 11.1, so we may also use Eq. 11.36:

$$\begin{aligned} P_T &= \sqrt{3}(199.58)(2.4) \cos 35.68^\circ \\ &= 673.92 \text{ W.} \end{aligned}$$

- c) The total power lost in the line is

$$P_{\text{line}} = 3(2.4)^2(0.8) = 13.824 \text{ W.}$$

- d) The total internal power lost in the generator is

$$P_{\text{gen}} = 3(2.4)^2(0.2) = 3.456 \text{ W.}$$

- e) The total number of magnetizing vars absorbed by the load is

$$\begin{aligned} Q_T &= \sqrt{3}(199.58)(2.4) \sin 35.68^\circ \\ &= 483.84 \text{ VAR.} \end{aligned}$$

- f) The total complex power associated with the source is

$$\begin{aligned} S_T &= 3S_\phi = -3(120)(2.4) \angle 36.87^\circ \\ &= -691.20 - j518.40 \text{ VA.} \end{aligned}$$

The minus sign indicates that the internal power and magnetizing reactive power are being delivered to the circuit. We check this result by calculating the total and reactive power absorbed by the circuit:

$$\begin{aligned} P &= 673.92 + 13.824 + 3.456 \\ &= 691.20 \text{ W (check),} \\ Q &= 483.84 + 3(2.4)^2(1.5) + 3(2.4)^2(0.5) \\ &= 483.84 + 25.92 + 8.64 \\ &= 518.40 \text{ VAR (check).} \end{aligned}$$

**Example 11.4** Calculating Power in a Three-Phase Wye-Delta Circuit

- Calculate the total complex power delivered to the  $\Delta$ -connected load of Example 11.2.
- What percentage of the average power at the sending end of the line is delivered to the load?

**Solution**

- a) Using the a-phase values from the solution of Example 11.2, we obtain

$$\mathbf{V}_\phi = \mathbf{V}_{AB} = 202.72 \angle 29.04^\circ \text{ V,}$$

$$\mathbf{I}_\phi = \mathbf{I}_{AB} = 1.39 \angle -6.87^\circ \text{ A.}$$

Using Eqs. 11.52 and 11.53, we have

$$\begin{aligned} S_T &= 3(202.72 \angle 29.04^\circ)(1.39 \angle 6.87^\circ) \\ &= 682.56 + j494.21 \text{ VA.} \end{aligned}$$

- b) The total power at the sending end of the distribution line equals the total power delivered to the load plus the total power lost in the line; therefore

$$\begin{aligned} P_{\text{input}} &= 682.56 + 3(2.4)^2(0.3) \\ &= 687.74 \text{ W.} \end{aligned}$$

The percentage of the average power reaching the load is  $682.56/687.74$ , or 99.25%. Nearly 100% of the average power at the input is delivered to the load because the impedance of the line is quite small compared to the load impedance.

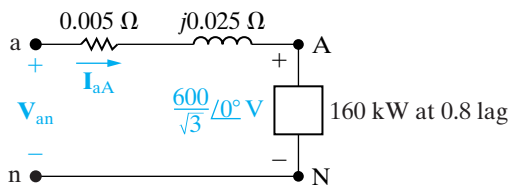
**Example 11.5** Calculating Three-Phase Power with an Unspecified Load

A balanced three-phase load requires 480 kW at a lagging power factor of 0.8. The load is fed from a line having an impedance of  $0.005 + j0.025 \Omega/\phi$ . The line voltage at the terminals of the load is 600 V.

- Construct a single-phase equivalent circuit of the system.
- Calculate the magnitude of the line current.
- Calculate the magnitude of the line voltage at the sending end of the line.
- Calculate the power factor at the sending end of the line.

**Solution**

- Figure 11.17 shows the single-phase equivalent circuit. We arbitrarily selected the line-to-neutral voltage at the load as the reference.



**Figure 11.17** ▲ The single-phase equivalent circuit for Example 11.5.

- The line current  $\mathbf{I}_{aA}^*$  is given by

$$\left(\frac{600}{\sqrt{3}}\right)\mathbf{I}_{aA}^* = (160 + j120)10^3,$$

or

$$\mathbf{I}_{aA}^* = 577.35 \angle 36.87^\circ \text{ A.}$$

Therefore,  $\mathbf{I}_{aA} = 577.35 \angle -36.87^\circ \text{ A}$ . The magnitude of the line current is the magnitude of  $\mathbf{I}_{aA}$ :

$$I_L = 577.35 \text{ A.}$$

We obtain an alternative solution for  $I_L$  from the expression

$$\begin{aligned} P_T &= \sqrt{3}V_L I_L \cos \theta_p \\ &= \sqrt{3}(600)I_L(0.8) \\ &= 480,000 \text{ W;} \\ I_L &= \frac{480,000}{\sqrt{3}(600)(0.8)} \\ &= \frac{1000}{\sqrt{3}} \\ &= 577.35 \text{ A.} \end{aligned}$$

- To calculate the magnitude of the line voltage at the sending end, we first calculate  $\mathbf{V}_{an}$ . From Fig. 11.17,

$$\begin{aligned} \mathbf{V}_{an} &= \mathbf{V}_{AN} + Z_\ell \mathbf{I}_{aA} \\ &= \frac{600}{\sqrt{3}} + (0.005 + j0.025)(577.35 \angle -36.87^\circ) \\ &= 357.51 \angle 1.57^\circ \text{ V.} \end{aligned}$$

Thus

$$\begin{aligned} V_L &= \sqrt{3}|\mathbf{V}_{an}| \\ &= 619.23 \text{ V.} \end{aligned}$$

- The power factor at the sending end of the line is the cosine of the phase angle between  $\mathbf{V}_{an}$  and  $\mathbf{I}_{aA}$ :

$$\begin{aligned} \text{pf} &= \cos [1.57^\circ - (-36.87^\circ)] \\ &= \cos 38.44^\circ \\ &= 0.783 \text{ lagging.} \end{aligned}$$

An alternative method for calculating the power factor is to first calculate the complex power at the sending end of the line:

$$\begin{aligned} S_\phi &= (160 + j120)10^3 + (577.35)^2(0.005 + j0.025) \\ &= 161.67 + j128.33 \text{ kVA} \\ &= 206.41 \angle 38.44^\circ \text{ kVA.} \end{aligned}$$

The power factor is

$$\begin{aligned} \text{pf} &= \cos 38.44^\circ \\ &= 0.783 \text{ lagging.} \end{aligned}$$

Finally, if we calculate the total complex power at the sending end, after first calculating the magnitude of the line current, we may use this value to calculate  $V_L$ . That is,

$$\begin{aligned} \sqrt{3}V_L I_L &= 3(206.41) \times 10^3, \\ V_L &= \frac{3(206.41) \times 10^3}{\sqrt{3}(577.35)}, \\ &= 619.23 \text{ V.} \end{aligned}$$

## ✓ ASSESSMENT PROBLEMS

### Objective 3—Be able to calculate power (average, reactive, and complex) in any three-phase circuit

**11.8** The three-phase average power rating of the central processing unit (CPU) on a mainframe digital computer is 22,659 W. The three-phase line supplying the computer has a line voltage rating of 208 V (rms). The line current is 73.8 A (rms). The computer absorbs magnetizing VARs.

- Calculate the total magnetizing reactive power absorbed by the CPU.
- Calculate the power factor.

**Answer:** (a) 13,909.50 VAR;  
(b) 0.852 lagging.

*NOTE:* Also try Chapter Problems 11.25 and 11.27.

**11.9** The complex power associated with each phase of a balanced load is  $144 + j192$  kVA. The line voltage at the terminals of the load is 2450 V.

- What is the magnitude of the line current feeding the load?
- The load is delta connected, and the impedance of each phase consists of a resistance in parallel with a reactance. Calculate  $R$  and  $X$ .
- The load is wye connected, and the impedance of each phase consists of a resistance in series with a reactance. Calculate  $R$  and  $X$ .

**Answer:** (a) 169.67 A;  
(b)  $R = 41.68 \Omega$ ,  $X = 31.26 \Omega$ ;  
(c)  $R = 5 \Omega$ ,  $X = 6.67 \Omega$ .

## 11.6 Measuring Average Power in Three-Phase Circuits

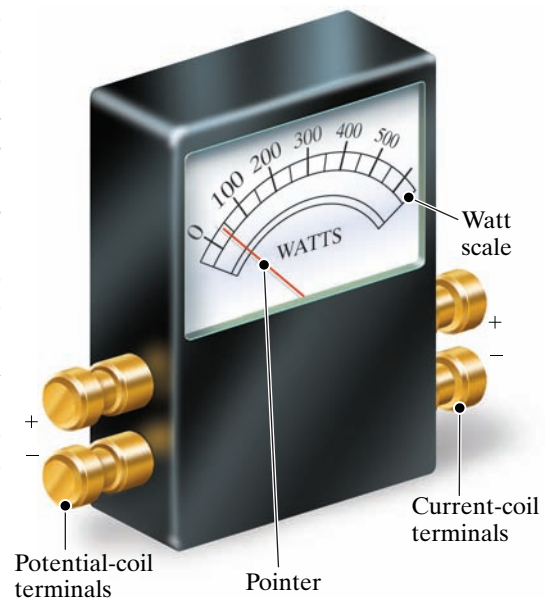
The basic instrument used to measure power in three-phase circuits is the electrodynamic wattmeter. It contains two coils. One coil, called the **current coil**, is stationary and is designed to carry a current proportional to the load current. The second coil, called the **potential coil**, is movable and carries a current proportional to the load voltage. The important features of the wattmeter are shown in Fig. 11.18.

The average deflection of the pointer attached to the movable coil is proportional to the product of the effective value of the current in the current coil, the effective value of the voltage impressed on the potential coil, and the cosine of the phase angle between the voltage and current. The direction in which the pointer deflects depends on the instantaneous polarity of the current-coil current and the potential-coil voltage. Therefore each coil has one terminal with a polarity mark—usually a plus sign—but sometimes the double polarity mark  $\pm$  is used. The wattmeter deflects upscale when (1) the polarity-marked terminal of the current coil is toward the source, and (2) the polarity-marked terminal of the potential coil is connected to the same line in which the current coil has been inserted.

### The Two-Wattmeter Method

Consider a general network inside a box to which power is supplied by  $n$  conducting lines. Such a system is shown in Fig. 11.19.

If we wish to measure the total power at the terminals of the box, we need to know  $n - 1$  currents and voltages. This follows because if we choose one terminal as a reference, there are only  $n - 1$  independent voltages. Likewise, only  $n - 1$  independent currents can exist in the  $n$  conductors entering the box. Thus the total power is the sum of  $n - 1$  product terms; that is,  $p = v_1 i_1 + v_2 i_2 + \cdots + v_{n-1} i_{n-1}$ .



**Figure 11.18** ▲ The key features of the electrodynamic wattmeter.

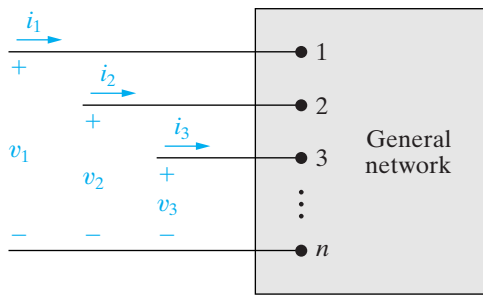


Figure 11.19 ▲ A general circuit whose power is supplied by  $n$  conductors.

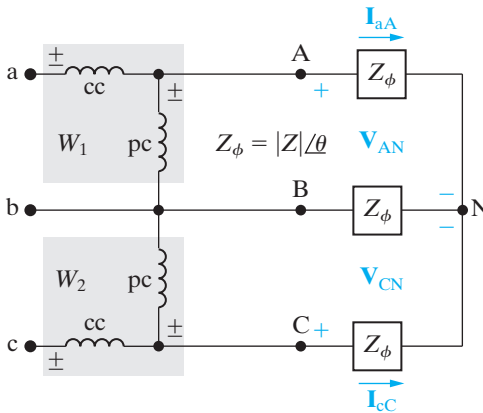


Figure 11.20 ▲ A circuit used to analyze the two-wattmeter method of measuring average power delivered to a balanced load.

Applying this general observation, we can see that for a three-conductor circuit, whether balanced or not, we need only two wattmeters to measure the total power. For a four-conductor circuit, we need three wattmeters if the three-phase circuit is unbalanced, but only two wattmeters if it is balanced, because in the latter case there is no current in the neutral line. Thus, only two wattmeters are needed to measure the total average power in any balanced three-phase system.

The two-wattmeter method reduces to determining the magnitude and algebraic sign of the average power indicated by each wattmeter. We can describe the basic problem in terms of the circuit shown in Fig. 11.20, where the two wattmeters are indicated by the shaded boxes and labeled  $W_1$  and  $W_2$ . The coil notations cc and pc stand for current coil and potential coil, respectively. We have elected to insert the current coils of the wattmeters in lines aA and cC. Thus, line bB is the reference line for the two potential coils. The load is connected as a wye, and the per-phase load impedance is designated as  $Z_\phi = |Z| \angle \theta$ . This is a general representation, as any  $\Delta$ -connected load can be represented by its Y equivalent; furthermore, for the balanced case, the impedance angle  $\theta$  is unaffected by the  $\Delta$ -to-Y transformation.

We now develop general equations for the readings of the two wattmeters. We assume that the current drawn by the potential coil of the wattmeter is negligible compared with the line current measured by the current coil. We further assume that the loads can be modeled by passive circuit elements so that the phase angle of the load impedance ( $\theta$  in Fig. 11.20) lies between  $-90^\circ$  (pure capacitance) and  $+90^\circ$  (pure inductance). Finally, we assume a positive phase sequence.

From our introductory discussion of the average deflection of the wattmeter, we can see that wattmeter 1 will respond to the product of  $|\mathbf{V}_{AB}|$ ,  $|\mathbf{I}_{aA}|$ , and the cosine of the angle between  $\mathbf{V}_{AB}$  and  $\mathbf{I}_{aA}$ . If we denote this wattmeter reading as  $W_1$ , we can write

$$\begin{aligned} W_1 &= |\mathbf{V}_{AB}| |\mathbf{I}_{aA}| \cos \theta_1 \\ &= V_L I_L \cos \theta_1. \end{aligned} \tag{11.54}$$

It follows that

$$\begin{aligned} W_2 &= |\mathbf{V}_{CB}| |\mathbf{I}_{cC}| \cos \theta_2 \\ &= V_L I_L \cos \theta_2. \end{aligned} \tag{11.55}$$

In Eq. 11.54,  $\theta_1$  is the phase angle between  $\mathbf{V}_{AB}$  and  $\mathbf{I}_{aA}$ , and in Eq. 11.55,  $\theta_2$  is the phase angle between  $\mathbf{V}_{CB}$  and  $\mathbf{I}_{cC}$ .

To calculate  $W_1$  and  $W_2$ , we express  $\theta_1$  and  $\theta_2$  in terms of the impedance angle  $\theta$ , which is also the same as the phase angle between the phase voltage and current. For a positive phase sequence,

$$\theta_1 = \theta + 30^\circ = \theta_\phi + 30^\circ, \tag{11.56}$$

$$\theta_2 = \theta - 30^\circ = \theta_\phi - 30^\circ. \tag{11.57}$$

The derivation of Eqs. 11.56 and 11.57 is left as an exercise (see Problem 11.35). When we substitute Eqs. 11.56 and 11.57 into Eqs. 11.54 and 11.55, respectively, we get

$$W_1 = V_L I_L \cos(\theta_\phi + 30^\circ), \tag{11.58}$$

$$W_2 = V_L I_L \cos(\theta_\phi - 30^\circ). \tag{11.59}$$



To find the total power, we add  $W_1$  and  $W_2$ ; thus

$$\begin{aligned} P_T &= W_1 + W_2 = 2V_L I_L \cos \theta_\phi \cos 30^\circ \\ &= \sqrt{3} V_L I_L \cos \theta_\phi, \end{aligned} \quad (11.60)$$

which is the expression for the total power in a three-phase circuit. Therefore we have confirmed that the sum of the two wattmeter readings yields the total average power.

A closer look at Eqs. 11.58 and 11.59 reveals the following about the readings of the two wattmeters:

1. If the power factor is greater than 0.5, both wattmeters read positive.
2. If the power factor equals 0.5, one wattmeter reads zero.
3. If the power factor is less than 0.5, one wattmeter reads negative.
4. Reversing the phase sequence will interchange the readings on the two wattmeters.

These observations are illustrated in the following example and in Problems 11.41–11.52.

### Example 11.6 Computing Wattmeter Readings in Three-Phase Circuits

Calculate the reading of each wattmeter in the circuit in Fig. 11.20 if the phase voltage at the load is 120 V and (a)  $Z_\phi = 8 + j6 \Omega$ ; (b)  $Z_\phi = 8 - j6 \Omega$ ; (c)  $Z_\phi = 5 + j5\sqrt{3} \Omega$ ; and (d)  $Z_\phi = 10 \angle -75^\circ \Omega$ . (e) Verify for (a)–(d) that the sum of the wattmeter readings equals the total power delivered to the load.

#### Solution

a)  $Z_\phi = 10 \angle 36.87^\circ \Omega$ ,  $V_L = 120\sqrt{3}$  V, and  $I_L = 120/10 = 12$  A.

$$\begin{aligned} W_1 &= (120\sqrt{3})(12) \cos(36.87^\circ + 30^\circ) \\ &= 979.75 \text{ W}, \end{aligned}$$

$$\begin{aligned} W_2 &= (120\sqrt{3})(12) \cos(36.87^\circ - 30^\circ) \\ &= 2476.25 \text{ W}. \end{aligned}$$

b)  $Z_\phi = 10 \angle -36.87^\circ \Omega$ ,  $V_L = 120\sqrt{3}$  V, and  $I_L = 120/10 = 12$  A.

$$\begin{aligned} W_1 &= (120\sqrt{3})(12) \cos(-36.87^\circ + 30^\circ) \\ &= 2476.25 \text{ W}, \end{aligned}$$

$$\begin{aligned} W_2 &= (120\sqrt{3})(12) \cos(-36.87^\circ - 30^\circ) \\ &= 979.75 \text{ W}. \end{aligned}$$

c)  $Z_\phi = 5(1 + j\sqrt{3}) = 10 \angle 60^\circ \Omega$ ,  $V_L = 120\sqrt{3}$  V, and  $I_L = 12$  A.

$$W_1 = (120\sqrt{3})(12) \cos(60^\circ + 30^\circ) = 0,$$

$$\begin{aligned} W_2 &= (120\sqrt{3})(12) \cos(60^\circ - 30^\circ) \\ &= 2160 \text{ W}. \end{aligned}$$

d)  $Z_\phi = 10 \angle -75^\circ \Omega$ ,  $V_L = 120\sqrt{3}$  V, and  $I_L = 12$  A.

$$W_1 = (120\sqrt{3})(12) \cos(-75^\circ + 30^\circ) = 1763.63 \text{ W},$$

$$W_2 = (120\sqrt{3})(12) \cos(-75^\circ - 30^\circ) = -645.53 \text{ W}.$$

e)  $P_T(a) = 3(12)^2(8) = 3456$  W,

$$\begin{aligned} W_1 + W_2 &= 979.75 + 2476.25 \\ &= 3456 \text{ W}, \end{aligned}$$

$$P_T(b) = P_T(a) = 3456 \text{ W},$$

$$\begin{aligned} W_1 + W_2 &= 2476.25 + 979.75 \\ &= 3456 \text{ W}, \end{aligned}$$

$$P_T(c) = 3(12)^2(5) = 2160 \text{ W},$$

$$\begin{aligned} W_1 + W_2 &= 0 + 2160 \\ &= 2160 \text{ W}, \end{aligned}$$

$$P_T(d) = 3(12)^2(2.5882) = 1118.10 \text{ W},$$

$$\begin{aligned} W_1 + W_2 &= 1763.63 - 645.53 \\ &= 1118.10 \text{ W}. \end{aligned}$$

**NOTE:** Assess your understanding of the two-wattmeter method by trying Chapter Problems 11.41 and 11.45.

## Practical Perspective

### Transmission and Distribution of Electric Power

At the start of this chapter we pointed out the obligation utilities have to maintain the rms voltage level at their customer's premises. Although the acceptable deviation from a nominal level may vary among different utilities we will assume for purposes of discussion that an allowable tolerance is  $\pm 5.8\%$ . Thus a nominal rms voltage of 120 V could range from 113 to 127 V. We also pointed out that capacitors strategically located on the system could be used to support voltage levels.

The circuit shown in Fig. 11.21 represents a substation on a Midwestern municipal system. We will assume the system is balanced, the line-to-line voltage at the substation is 13.8 kV, the phase impedance of the distribution line is  $0.6 + j4.8\Omega$ , and the load at the substation at 3 PM on a hot, humid day in July is 3.6 MW and 3.6 magnetizing MVAR.

Using the line-to-neutral voltage at the substation as a reference, the single-phase equivalent circuit for the system in Fig. 11.21 is shown in Fig. 11.22. The line current can be calculated from the expression for the complex power at the substation. Thus,

$$\frac{13,800}{\sqrt{3}} \mathbf{I}_{aA}^* = (1.2 + j1.2)10^6.$$

It follows that

$$\mathbf{I}_{aA}^* = 150.61 + j150.61 \text{ A}$$

or

$$\mathbf{I}_{aA} = 150.61 - j150.61 \text{ A}.$$

The line-to-neutral voltage at the generating plant is

$$\begin{aligned} \mathbf{V}_{an} &= \frac{13,800}{\sqrt{3}} \angle 0^\circ + (0.6 + j4.8)(150.61 - j150.61) \\ &= 8780.74 + j632.58 \\ &= 8803.50 \angle 4.12^\circ \text{ V}. \end{aligned}$$

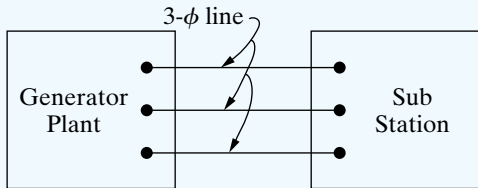
Therefore the magnitude of the line voltage at the generating plant is

$$|\mathbf{V}_{ab}| = \sqrt{3}(8803.50) = 15,248.11 \text{ V}.$$

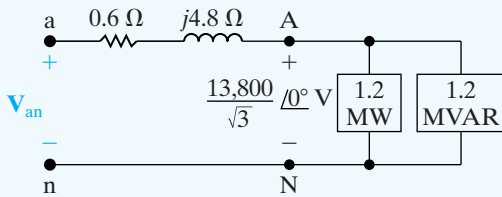
We are assuming the utility is required to keep the voltage level within  $\pm 5.8\%$  of the nominal value. This means the magnitude of the line-to-line voltage at the power plant should not exceed 14.6 kV nor be less than 13 kV. Therefore, the magnitude of the line voltage at the generating plant could cause problems for customers.

When the magnetizing vars are supplied by a capacitor bank connected to the substation bus, the line current  $\mathbf{I}_{aA}$  becomes

$$\mathbf{I}_{aA} = 150.61 + j0 \text{ A}.$$



**Figure 11.21** ▲ A substation connected to a power plant via a three-phase line.



**Figure 11.22** ▲ A single phase equivalent circuit for the system in Fig. 11.21.

Therefore the voltage at the generating plant necessary to maintain a line-to-line voltage of 13,800 V at the substation is

$$\begin{aligned} \mathbf{V}_{an} &= \frac{13,800}{\sqrt{3}} \angle 0^\circ + (0.6 + j4.8)(150.61 + j0) \\ &= 8057.80 + j722.94 \\ &= 8090.17 \angle 5.13^\circ \text{ V.} \end{aligned}$$

Hence

$$|\mathbf{V}_{ab}| = \sqrt{3}(8090.17) = 14,012.58 \text{ V.}$$

This voltage level falls within the allowable range of 13 kV to 14.6 kV.

*NOTE: Assess your understanding of this Practical Perspective by trying Chapter Problems 11.53(a)–(b) and 11.54, 11.57, and 11.58.*

## Summary

- When analyzing balanced three-phase circuits, the first step is to transform any  $\Delta$  connections into Y connections, so that the overall circuit is of the Y-Y configuration. (See page 400.)
- A **single-phase equivalent circuit** is used to calculate the line current and the phase voltage in one phase of the Y-Y structure. The a-phase is normally chosen for this purpose. (See page 402.)
- Once we know the line current and phase voltage in the a-phase equivalent circuit, we can take analytical shortcuts to find any current or voltage in a balanced three-phase circuit, based on the following facts:
  - The b- and c-phase currents and voltages are identical to the a-phase current and voltage except for a  $120^\circ$  shift in phase. In a positive-sequence circuit, the b-phase quantity lags the a-phase quantity by  $120^\circ$ , and the c-phase quantity leads the a-phase quantity by  $120^\circ$ . For a negative sequence circuit, phases b and c are interchanged with respect to phase a.
  - The set of line voltages is out of phase with the set of phase voltages by  $\pm 30^\circ$ . The plus or minus sign corresponds to positive and negative sequence, respectively.
  - In a Y-Y circuit the magnitude of a line voltage is  $\sqrt{3}$  times the magnitude of a phase voltage.
  - The set of line currents is out of phase with the set of phase currents in  $\Delta$ -connected sources and loads by  $\mp 30^\circ$ . The minus or plus sign corresponds to positive and negative sequence, respectively.
  - The magnitude of a line current is  $\sqrt{3}$  times the magnitude of a phase current in a  $\Delta$ -connected source or load. (See pages 402–403 and 405–406.)
  - The techniques for calculating per-phase average power, reactive power, and complex power are identical to those introduced in Chapter 10. (See page 408.)
  - The total real, reactive, and complex power can be determined either by multiplying the corresponding per phase quantity by 3 or by using the expressions based on line current and line voltage, as given by Eqs. 11.36, 11.38, and 11.41. (See pages 408 and 409.)
  - The total instantaneous power in a balanced three-phase circuit is constant and equals 1.5 times the average power per phase. (See page 410.)
  - A wattmeter measures the average power delivered to a load by using a current coil connected in series with the load and a potential coil connected in parallel with the load. (See page 413.)
  - The total average power in a balanced three-phase circuit can be measured by summing the readings of two wattmeters connected in two different phases of the circuit. (See page 413.)

## Problems

All phasor voltages in the following Problems are stated in terms of the rms value.

### Section 11.1

**11.1** What is the phase sequence of each of the following sets of voltages?

a)  $v_a = 137 \cos(\omega t + 63^\circ) \text{ V}$ ,  
 $v_b = 137 \cos(\omega t - 57^\circ) \text{ V}$ ,  
 $v_c = 137 \cos(\omega t + 183^\circ) \text{ V}$ .

b)  $v_a = 820 \cos(\omega t - 36^\circ) \text{ V}$ ,  
 $v_b = 820 \cos(\omega t + 84^\circ) \text{ V}$ ,  
 $v_c = 820 \sin(\omega t - 66^\circ) \text{ V}$ .

**11.2** For each set of voltages, state whether or not the voltages form a balanced three-phase set. If the set is balanced, state whether the phase sequence is positive or negative. If the set is not balanced, explain why.

PSPICE  
MULTISIM

a)  $v_a = 48 \cos(314t - 45^\circ) \text{ V}$ ,  
 $v_b = 48 \cos(314t - 165^\circ) \text{ V}$ ,  
 $v_c = 48 \cos(314t + 75^\circ) \text{ V}$ .

b)  $v_a = 188 \cos(250t + 60^\circ) \text{ V}$ ,  
 $v_b = -188 \cos 250t \text{ V}$ ,  
 $v_c = 188 \cos(250t - 60^\circ) \text{ V}$ .

c)  $v_a = 426 \cos 100t \text{ V}$ ,  
 $v_b = 462 \cos(100t + 120^\circ) \text{ V}$ ,  
 $v_c = 426 \cos(100t - 120^\circ) \text{ V}$ .

d)  $v_a = 1121 \cos(2000t - 20^\circ) \text{ V}$ ,  
 $v_b = 1121 \sin(2000t - 50^\circ) \text{ V}$ ,  
 $v_c = 1121 \cos(2000t + 100^\circ) \text{ V}$ .

e)  $v_a = 540 \sin 630t \text{ V}$ ,  
 $v_b = 540 \cos(630t - 120^\circ) \text{ V}$ ,  
 $v_c = 540 \cos(630t + 120^\circ) \text{ V}$ .

f)  $v_a = 144 \cos(800t + 80^\circ) \text{ V}$ ,  
 $v_b = 144 \sin(800t - 70^\circ) \text{ V}$ ,  
 $v_c = 144 \sin(800t + 50^\circ) \text{ V}$ .

**11.3** Verify that Eq. 11.3 is true for either Eq. 11.1 or Eq. 11.2.

### Section 11.2

**11.4** Refer to the circuit in Fig. 11.5(b). Assume that there are no external connections to the terminals a, b, c. Assume further that the three windings are from a three-phase generator whose voltages are those described in Problem 11.2(b). Determine the current circulating in the  $\Delta$ -connected generator.

**11.5** Repeat Problem 11.4 but assume that the three-phase voltages are those described in Problem 11.2(c).

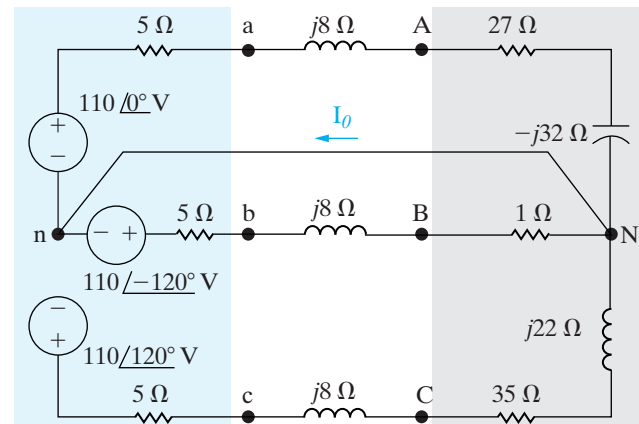
### Section 11.3

**11.6** a) Is the circuit in Fig. P11.6 a balanced or unbalanced three-phase system? Explain.

PSPICE  
MULTISIM

b) Find  $I_\theta$ .

Figure P11.6

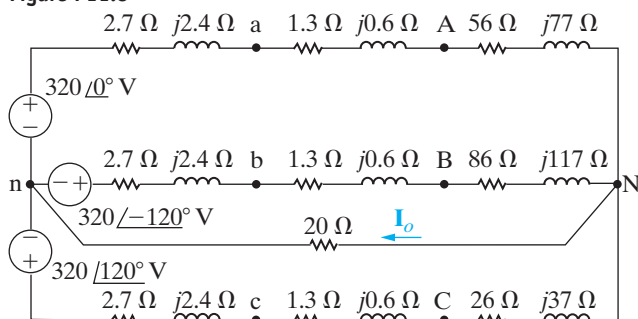


- 11.7** a) Find  $I_o$  in the circuit in Fig. P11.7.  
 b) Find  $V_{AN}$ .  
 c) Find  $V_{AB}$ .  
 d) Is the circuit a balanced or unbalanced three-phase system?

PSPICE  
MULTISIM

- 11.8** Find the rms value of  $I_o$  in the unbalanced three-phase circuit seen in Fig. P11.8.

Figure P11.8



- 11.9** The time-domain expressions for three line-to-neutral voltages at the terminals of a Y-connected load are

$$v_{AN} = 288 \cos(\omega t - 45^\circ) \text{ V},$$

$$v_{BN} = 288 \cos(\omega t - 165^\circ) \text{ V},$$

$$v_{CN} = 288 \cos(\omega t + 75^\circ) \text{ V}.$$

What are the time-domain expressions for the three line-to-line voltages  $v_{AB}$ ,  $v_{BC}$ , and  $v_{CA}$ ?

- 11.10** A balanced three-phase circuit has the following characteristics:

- Y-Y connected;
  - The line voltage at the source,  $V_{ab}$ , is  $110\sqrt{3} \angle -60^\circ \text{ V}$ ;
  - The phase sequence is positive;
  - The line impedance is  $3 + j2 \Omega/\phi$ ;
  - The load impedance is  $37 + j28 \Omega/\phi$ ;
- a) Draw the single phase equivalent circuit for the a-phase.  
 b) Calculate the line current in the a-phase.  
 c) Calculate the line voltage at the load in the a-phase.

- 11.11** The magnitude of the line voltage at the terminals of a balanced Y-connected load is 6600 V. The load impedance is  $240 - j70 \Omega/\phi$ . The load is fed from a line that has an impedance of  $0.5 + j4 \Omega/\phi$ .

- a) What is the magnitude of the line current?  
 b) What is the magnitude of the line voltage at the source?

- 11.12** The magnitude of the phase voltage of an ideal balanced three-phase Y-connected source is 125 V. The source is connected to a balanced Y-connected load by a distribution line that has an impedance of  $0.1 + j0.8 \Omega/\phi$ . The load impedance is  $19.9 + j14.2 \Omega/\phi$ . The phase sequence of the source is acb. Use the a-phase voltage of the source as the reference. Specify the magnitude and phase angle of the following quantities: (a) the three line currents, (b) the three line voltages at the source, (c) the three phase voltages at the load, and (d) the three line voltages at the load.

#### Section 11.4

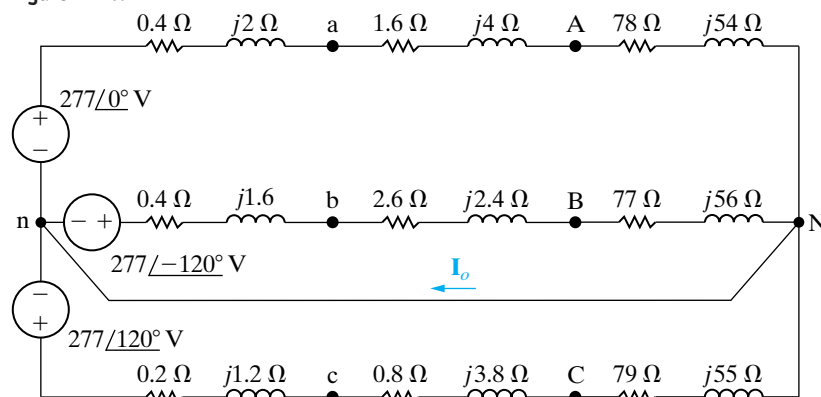
- 11.13** A balanced  $\Delta$ -connected load has an impedance of  $216 - j288 \Omega/\phi$ . The load is fed through a line having an impedance of  $3 + j5 \Omega/\phi$ . The phase voltage at the terminals of the load is 7.2 kV. The phase sequence is negative. Use  $V_{AB}$  as the reference.

- a) Calculate the three phase currents of the load.  
 b) Calculate the three line currents.  
 c) Calculate the three line voltages at the sending end of the line.

- 11.14** A balanced, three-phase circuit is characterized as follows:

- Y- $\Delta$  connected;
- Source voltage in the b-phase is  $150 \angle 135^\circ \text{ V}$ ;
- Source phase sequence is acb;
- Line impedance is  $2 + j3 \Omega/\phi$ ;
- Load impedance is  $129 + j171 \Omega/\phi$ .

Figure P11.7



- a) Draw the single phase equivalent for the a-phase.
- b) Calculate the a-phase line current.
- c) Calculate the a-phase line voltage for the three-phase load.

**11.15** An acb sequence balanced three-phase Y-connected source supplies power to a balanced, three-phase  $\Delta$ -connected load with an impedance of  $12 + j9 \Omega/\phi$ . The source voltage in the b-phase is  $240\angle -50^\circ \text{ V}$ . The line impedance is  $1 + j1 \Omega/\phi$ . Draw the single phase equivalent circuit for the a-phase and use it to find the current in the a-phase of the load.

**11.16** In a balanced three-phase system, the source is a balanced Y with an abc phase sequence and a line voltage  $V_{ab} = 208\angle 50^\circ \text{ V}$ . The load is a balanced Y in parallel with a balanced  $\Delta$ . The phase impedance of the Y is  $4 + j3 \Omega/\phi$  and the phase impedance of the  $\Delta$  is  $3 - j9 \Omega/\phi$ . The line impedance is  $1.4 + j0.8 \Omega/\phi$ . Draw the single phase equivalent circuit and use it to calculate the line voltage at the load in the a-phase.

**11.17** A balanced Y-connected load having an impedance of  $60 - j45 \Omega/\phi$  is connected in parallel with a balanced  $\Delta$ -connected load having an impedance of  $90\sqrt{2}\angle 45^\circ \Omega/\phi$ . The paralleled loads are fed from a line having an impedance of  $2 + j2 \Omega/\phi$ . The magnitude of the line-to-line voltage of the  $\Delta$ -load is  $300\sqrt{3} \text{ V}$ .

- a) Calculate the magnitude of the phase current in the Y-connected load.
- b) Calculate the magnitude of the phase current in the  $\Delta$ -connected load.
- c) Calculate the magnitude of the current in the line feeding the loads.
- d) Calculate the magnitude of the line voltage at the sending end of the line.

**11.18** A three-phase  $\Delta$ -connected generator has an internal impedance of  $9 + j90 \text{ m}\Omega/\phi$ . When the load is removed from the generator, the magnitude of the terminal voltage is 13,800 V. The generator feeds a  $\Delta$ -connected load through a transmission line with an impedance of  $20 + j180 \text{ m}\Omega/\phi$ . The per-phase impedance of the load is  $7.056 + j3.417 \Omega$ .

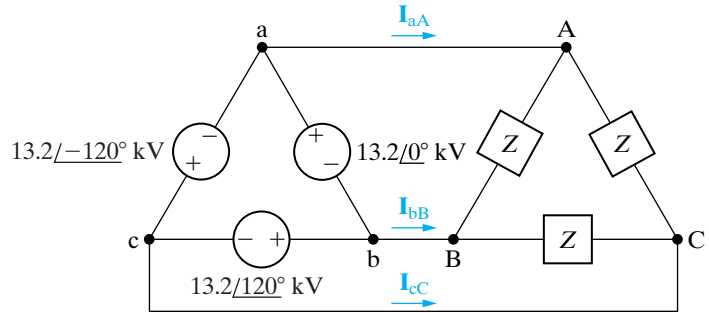
- a) Construct a single-phase equivalent circuit.
- b) Calculate the magnitude of the line current.
- c) Calculate the magnitude of the line voltage at the terminals of the load.
- d) Calculate the magnitude of the line voltage at the terminals of the source.

- e) Calculate the magnitude of the phase current in the load.
- f) Calculate the magnitude of the phase current in the source.

**11.19** The impedance  $Z$  in the balanced three-phase circuit in Fig. P11.19 is  $100 - j75 \Omega$ . Find

- a)  $I_{AB}$ ,  $I_{BC}$ , and  $I_{CA}$ ,
- b)  $I_{aA}$ ,  $I_{bB}$ , and  $I_{cC}$ ,
- c)  $I_{ba}$ ,  $I_{cb}$ , and  $I_{ac}$ .

Figure P11.19

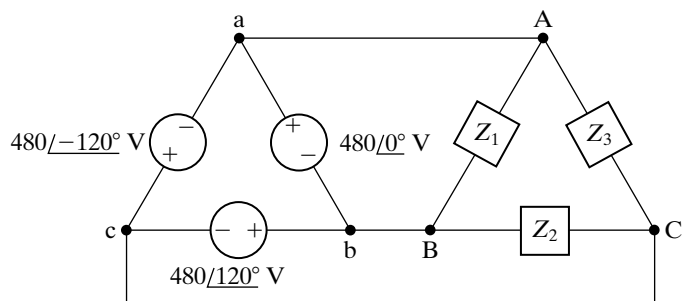


**11.20** For the circuit shown in Fig. P11.20, find

PSPICE  
MULTISIM

- a) the phase currents  $I_{AB}$ ,  $I_{BC}$ , and  $I_{CA}$
- b) the line currents  $I_{aA}$ ,  $I_{bB}$ , and  $I_{cC}$  when  $Z_1 = 2.4 - j0.7 \Omega$ ,  $Z_2 = 8 + j6 \Omega$ , and  $Z_3 = 20 + j0 \Omega$ .

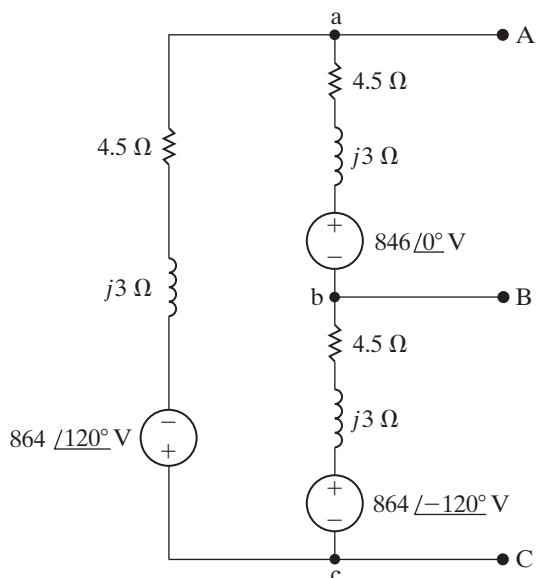
Figure P11.20



**11.21** A balanced three-phase  $\Delta$ -connected source is shown in Fig. P11.21.

- a) Find the Y-connected equivalent circuit.
- b) Show that the Y-connected equivalent circuit delivers the same open-circuit voltage as the original  $\Delta$ -connected source.
- c) Apply an external short circuit to the terminals A, B, and C. Use the  $\Delta$ -connected source to find the three line currents  $I_{aA}$ ,  $I_{bB}$ , and  $I_{cC}$ .
- d) Repeat (c) but use the Y-equivalent source to find the three line currents.

Figure P11.21

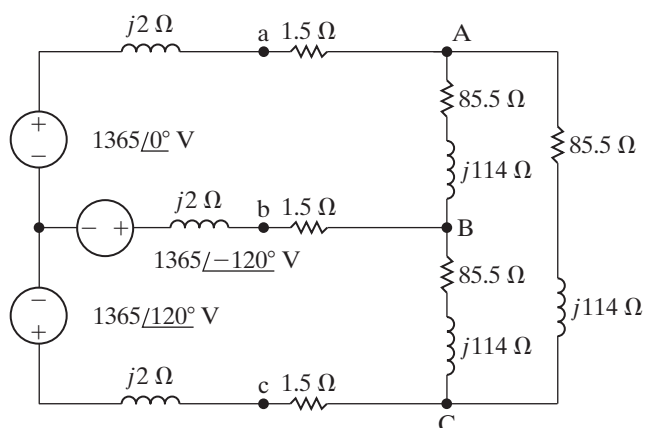


- 11.22** The  $\Delta$ -connected source of Problem 11.21 is connected to a Y-connected load by means of a balanced three-phase distribution line. The load impedance is  $1192 + j1584 \Omega/\phi$ , and the line impedance is  $6.5 + j15 \Omega/\phi$ .
- Construct a single-phase equivalent circuit of the system.
  - Determine the magnitude of the line voltage at the terminals of the load.
  - Determine the magnitude of the phase current in the  $\Delta$ -source.
  - Determine the magnitude of the line voltage at the terminals of the source.

## Section 11.5

- 11.23**
- Find the rms magnitude and the phase angle of  $\mathbf{I}_{CA}$  in the circuit shown in Fig. P11.23.
  - What percent of the average power delivered by the three-phase source is dissipated in the three-phase load?

Figure P11.23

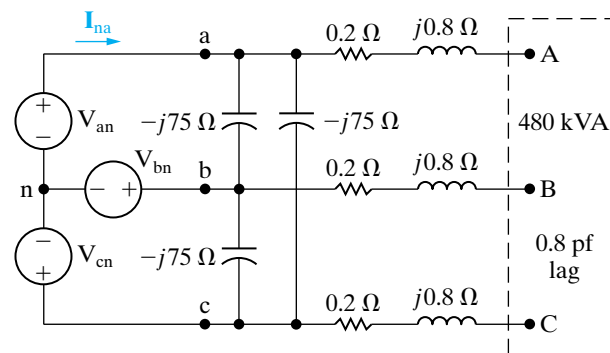


- 11.24** A balanced three-phase source is supplying 60 kVA at 0.6 lagging to two balanced Y-connected parallel loads. The distribution line connecting the source to the load has negligible impedance. Load 1 is purely resistive and absorbs 30 kW. Find the per-phase impedance of Load 2 if the line voltage is  $120\sqrt{3}$  V and the impedance components are in series.

- 11.25** In a balanced three-phase system, the source has an abc sequence, is Y-connected, and  $\mathbf{V}_{an} = 120\angle 20^\circ$  V. The source feeds two loads, both of which are Y-connected. The impedance of load 1 is  $8 + j6 \Omega/\phi$ . The complex power for the a-phase of load 2 is  $600\angle 36^\circ$  VA. Find the total complex power supplied by the source.

- 11.26** The line-to-neutral voltage at the terminals of the balanced three-phase load in the circuit shown in Fig. P11.26 is 1600 V. At this voltage, the load is absorbing 480 kVA at 0.8 pf lag.
- Use  $\mathbf{V}_{AN}$  as the reference and express  $\mathbf{I}_{na}$  in polar form.
  - Calculate the complex power associated with the ideal three-phase source.
  - Check that the total average power delivered equals the total average power absorbed.
  - Check that the total magnetizing reactive power delivered equals the total magnetizing reactive power absorbed.

Figure P11.26



- 11.27** A three-phase positive sequence Y-connected source supplies 14 kVA with a power factor of 0.75 lagging to a parallel combination of a Y-connected load and a  $\Delta$ -connected load. The Y-connected load uses 9 kVA at a power factor of 0.6 lagging and has an a-phase current of  $10\angle -30^\circ$  A.

- Find the complex power per phase of the  $\Delta$ -connected load.
- Find the magnitude of the line voltage.



**11.28** A balanced three-phase distribution line has an impedance of  $5 + j10 \Omega/\phi$ . This line is used to supply three balanced three-phase loads that are connected in parallel. The three loads are  $L_1 = 180 \text{ kVA}$  at 0.866 pf lag,  $L_2 = 150 \text{ kVA}$  at 0.28 pf lead, and  $L_3 = 72.12 \text{ kW}$  at unity pf. The magnitude of the line voltage at the terminals of the loads is  $1800\sqrt{3} \text{ V}$ .

- What is the magnitude of the line voltage at the sending end of the line?
- What is the percent efficiency of the distribution line with respect to average power?

**11.29** The three tools described below are part of a university's machine shop. Each piece of equipment is a balanced three-phase load rated at 220 V(rms). Calculate (a) the magnitude of the line current supplying these three tools and (b) the power factor of the combined load.

- Drill press: 10.2 kVA at 0.87 pf lag.
- Lathe: 4.2 kW at 0.91 pf lag.
- Band saw: line current 36.8 A(rms), 7.25 kVAR.

**11.30** Calculate the complex power in each phase of the unbalanced load in Problem 11.20.

**11.31** Show that the total instantaneous power in a balanced three-phase circuit is constant and equal to  $1.5V_m I_m \cos \theta_\phi$ , where  $V_m$  and  $I_m$  represent the maximum amplitudes of the phase voltage and phase current, respectively.

**11.32** The total apparent power supplied in a balanced, three-phase Y- $\Delta$  system is 4800 VA. The line voltage is 240 V. If the line impedance is negligible and the power factor angle of the load is  $-50^\circ$ , determine the impedance of the load.

**11.33** A balanced three-phase load absorbs 150 kVA at a leading power factor of 0.96 when the line voltage at the terminals of the load is 600 V. Find four equivalent circuits that can be used to model this load.

**11.34** At full load, a commercially available 100 hp, three-phase induction motor operates at an efficiency of 97% and a power factor of 0.88 lag. The motor is supplied from a three-phase outlet with a line-voltage rating of 208 V.

- What is the magnitude of the line current drawn from the 208 V outlet? (1 hp = 746 W.)
- Calculate the reactive power supplied to the motor.

**11.35** A three-phase line has an impedance of  $0.1 + j0.8 \Omega/\phi$ . The line feeds two balanced three-phase loads connected in parallel. The first load is absorbing a total of 630 kW and absorbing 840 kVAR magnetizing vars. The second load is Y-connected and has an impedance of  $15.36 - j4.48 \Omega/\phi$ . The line-to-neutral voltage at the load end of the line is 4000 V. What is the magnitude of the line voltage at the source end of the line?

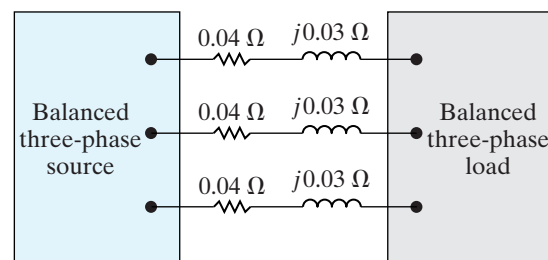
**11.36** Three balanced three-phase loads are connected in parallel. Load 1 is Y-connected with an impedance of  $400 + j300 \Omega/\phi$ ; load 2 is  $\Delta$ -connected with an impedance of  $2400 - j1800 \Omega/\phi$ ; and load 3 is  $172.8 + j2203.2 \text{ kVA}$ . The loads are fed from a distribution line with an impedance of  $2 + j16 \Omega/\phi$ . The magnitude of the line-to-neutral voltage at the load end of the line is  $24\sqrt{3} \text{ kV}$ .

- Calculate the total complex power at the sending end of the line.
- What percentage of the average power at the sending end of the line is delivered to the loads?

**11.37** The output of the balanced positive-sequence three-phase source in Fig. P11.37 is 41.6 kVA at a lagging power factor of 0.707. The line voltage at the source is 240 V.

- Find the magnitude of the line voltage at the load.
- Find the total complex power at the terminals of the load.

Figure P11.37



**11.38** A balanced three-phase source is supplying 540 kVA at 0.96 pf lag to two balanced  $\Delta$ -connected parallel loads. The distribution line connecting the source to the load has negligible impedance. The power associated with load 1 is  $38.4 - j208.8 \text{ kVA}$ .

- Determine the types of components and their impedances in each phase of load 2 if the line voltage is  $1600\sqrt{3} \text{ V}$  and the impedance components are in series.
- Repeat (a) with the impedance components in parallel.

**11.39** The total power delivered to a balanced three-phase load when operating at a line voltage of  $2500\sqrt{3}$  V is 900 kW at a lagging power factor of 0.6. The impedance of the distribution line supplying the load is  $1 + j3 \Omega/\phi$ . Under these operating conditions, the drop in the magnitude of the line voltage between the sending end and the load end of the line is excessive. To compensate, a bank of Y-connected capacitors is placed in parallel with the load. The capacitor bank is designed to furnish 1125 kVAR of magnetizing reactive power when operated at a line voltage of  $2500\sqrt{3}$  V.

- What is the magnitude of the voltage at the sending end of the line when the load is operating at a line voltage of  $2500\sqrt{3}$  V and the capacitor bank is disconnected?
- Repeat (a) with the capacitor bank connected.
- What is the average power efficiency of the line in (a)?
- What is the average power efficiency in (b)?
- If the system is operating at a frequency of 60 Hz, what is the size of each capacitor in microfarads?

**11.40** A balanced bank of delta-connected capacitors is connected in parallel with the load described in Assessment Problem 11.9. The effect is to place a capacitor in parallel with the load in each phase. The line voltage at the terminals of the load thus remains at 2450 V. The circuit is operating at a frequency of 60 Hz. The capacitors are adjusted so that the magnitude of the line current feeding the parallel combination of the load and capacitor bank is at its minimum.

- What is the size of each capacitor in microfarads?
- Repeat (a) for wye-connected capacitors.
- What is the magnitude of the line current?

### Section 11.6

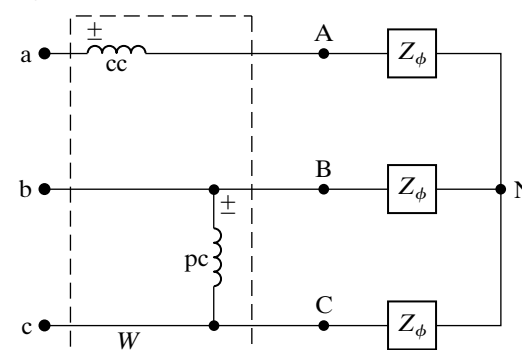
**11.41** The two-wattmeter method is used to measure the power at the load end of the line in Example 11.1. Calculate the reading of each wattmeter.

**11.42** The wattmeters in the circuit in Fig. 11.20 read as follows:  $W_1 = 40,823.09$  W, and  $W_2 = 103,176.91$  W. The magnitude of the line voltage is  $2400\sqrt{3}$  V. The phase sequence is positive. Find  $Z_\phi$ .

**11.43** In the balanced three-phase circuit shown in Fig. P11.43, the current coil of the wattmeter is connected in line aA, and the potential coil of the wattmeter is connected across lines b and c. Show

that the wattmeter reading multiplied by  $\sqrt{3}$  equals the total reactive power associated with the load. The phase sequence is positive.

Figure P11.43



**11.44** The line-to-neutral voltage in the circuit in Fig. P11.43 is 680 V, the phase sequence is positive, and the load impedance is  $16 - j12 \Omega/\phi$ .

- Calculate the wattmeter reading.
- Calculate the total reactive power associated with the load.

**11.45** The two wattmeters in Fig. 11.20 can be used to compute the total reactive power of the load.

- Prove this statement by showing that  $\sqrt{3}(W_2 - W_1) = \sqrt{3}V_L I_L \sin \theta_\phi$ .
- Compute the total reactive power from the wattmeter readings for each of the loads in Example 11.6. Check your computations by calculating the total reactive power directly from the given voltage and impedance.

**11.46** Derive Eqs. 11.56 and 11.57.

**11.47** a) Calculate the complex power associated with each phase of the balanced load in Problem 11.19.

- If the two-wattmeter method is used to measure the average power delivered to the load, specify the reading of each meter.

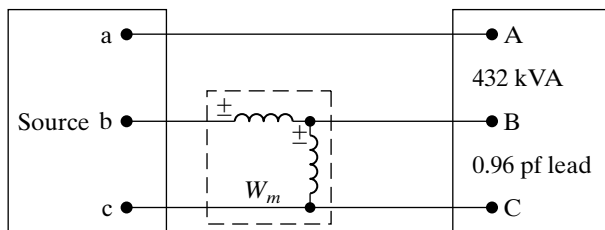
**11.48** The two-wattmeter method is used to measure the power delivered to the unbalanced load in Problem 11.20. The current coil of wattmeter 1 is placed in line aA and that of wattmeter 2 is placed in line bB.

- Calculate the reading of wattmeter 1.
- Calculate the reading of wattmeter 2.
- Show that the sum of the two wattmeter readings equals the total power delivered to the unbalanced load.

**11.49** The balanced three-phase load shown in Fig. P11.49 is fed from a balanced, positive-sequence, three-phase Y-connected source. The impedance of the line connecting the source to the load is negligible. The line-to-neutral voltage of the source is 7200 V.

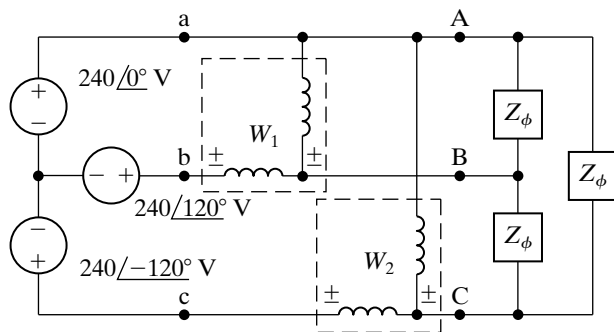
- Find the reading of the wattmeter in watts.
- Explain how you would connect a second wattmeter in the circuit so that the two wattmeters would measure the total power.
- Calculate the reading of the second wattmeter.
- Verify that the sum of the two wattmeter readings equals the total average power delivered to the load.

Figure P11.49



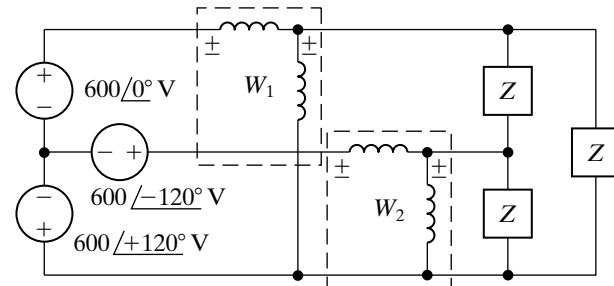
- 11.50** a) Calculate the reading of each wattmeter in the circuit shown in Fig. P11.50. The value of  $Z_\phi$  is  $40 \angle -30^\circ \Omega$ .
- b) Verify that the sum of the wattmeter readings equals the total average power delivered to the  $\Delta$ -connected load.

Figure P11.50



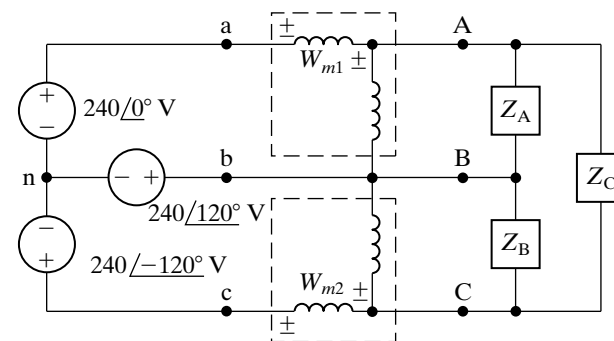
- 11.51** a) Calculate the reading of each wattmeter in the circuit shown in Fig. P11.51 when  $Z = 13.44 + j46.08 \Omega$ .
- b) Check that the sum of the two wattmeter readings equals the total power delivered to the load.
- c) Check that  $\sqrt{3}(W_1 - W_2)$  equals the total magnetizing vars delivered to the load.

Figure P11.51



- 11.52** a) Find the reading of each wattmeter in the circuit shown in Fig. P11.52 if  $Z_A = 20 \angle 30^\circ \Omega$ ,  $Z_B = 60 \angle 0^\circ \Omega$ , and  $Z_C = 40 \angle -30^\circ \Omega$ .
- b) Show that the sum of the wattmeter readings equals the total average power delivered to the unbalanced three-phase load.

Figure P11.52



**Sections 11.1–11.6**

**11.53** Refer to the Practical Perspective example:

**PRACTICAL PERSPECTIVE**

- Construct a power triangle for the substation load before the capacitors are connected to the bus.
- Repeat (a) after the capacitors are connected to the bus.
- Using the line-to-neutral voltage at the substation as a reference, construct a phasor diagram that depicts the relationship between  $\mathbf{V}_{AN}$  and  $\mathbf{V}_{an}$  before the capacitors are added.
- Assume a positive phase sequence and construct a phasor diagram that depicts the relationship between  $\mathbf{V}_{AB}$  and  $\mathbf{V}_{ab}$ .

**11.54** Refer to the Practical Perspective example. Assume the frequency of the utility is 60 Hz.

**PRACTICAL PERSPECTIVE**

- What is the  $\mu\text{F}$  rating of each capacitor if the capacitors are delta-connected?
- What is the  $\mu\text{F}$  rating of each capacitor if the capacitors are wye-connected?

**11.55** Choose a single capacitor from Appendix H that is closest to the  $\mu\text{F}$  rating of the wye-connected capacitor from Problem 11.54(b).

- How much reactive power will a capacitor bank using this new value supply?
- What line-to-line voltage at the generating plant will be required when this new capacitor bank is connected to the substation bus?

**11.56** Choose a single capacitor from Appendix H that is closest to the  $\mu\text{F}$  rating of the delta-connected capacitor from Problem 11.54(a).

- How much reactive power will a capacitor bank using this new value supply?
- What line-to-line voltage at the generating plant will be required when this new capacitor bank is connected to the substation bus?

**11.57** In the Practical Perspective example, what happens to the voltage level at the generating plant if the substation is maintained at 13.8 kV, the substation load is removed, and the added capacitor bank remains connected?

**11.58** In the Practical Perspective example, calculate the total line loss in kW before and after the capacitors are connected to the substation bus.

**11.59** Assume the load on the substation bus in the Practical Perspective example drops to 180 kW and

480 magnetizing kVAR. Also assume the capacitors remain connected to the substation.

- What is the magnitude of the line-to-line voltage at the generating plant that is required to maintain a line-to-line voltage of 13.8 kV at the substation?
- Will this power plant voltage level cause problems for other customers?

**11.60** Assume in Problem 11.59 that when the load drops to 180 kW and 480 magnetizing kVAR the capacitor bank at the substation is disconnected. Also assume that the line-to-line voltage at the substation is maintained at 13.8 kV.

- What is the magnitude of the line-to-line voltage at the generating plant?
- Is the voltage level found in (a) within the acceptable range of variation?
- What is the total line loss in kW when the capacitors stay on line after the load drops to  $180 + j480$  kVA?
- What is the total line loss in kW when the capacitors are removed after the load drops to  $180 + j480$  kVA?
- Based on your calculations, would you recommend disconnecting the capacitors after the load drops to  $180 + j480$  kVA? Explain.

# CHAPTER 12

## CHAPTER CONTENTS

- 12.1 Definition of the Laplace Transform *p.* 428
- 12.2 The Step Function *p.* 429
- 12.3 The Impulse Function *p.* 431
- 12.4 Functional Transforms *p.* 434
- 12.5 Operational Transforms *p.* 435
- 12.6 Applying the Laplace Transform *p.* 440
- 12.7 Inverse Transforms *p.* 442
- 12.8 Poles and Zeros of  $F(s)$  *p.* 452
- 12.9 Initial- and Final-Value Theorems *p.* 453

## ✓ CHAPTER OBJECTIVES

- 1 Be able to calculate the Laplace transform of a function using the definition of Laplace transform, the Laplace transform table, and/or a table of operational transforms.
- 2 Be able to calculate the inverse Laplace transform using partial fraction expansion and the Laplace transform table.
- 3 Understand and know how to use the initial value theorem and the final value theorem.

# Introduction to the Laplace Transform

We now introduce a powerful analytical technique that is widely used to study the behavior of linear, lumped-parameter circuits. The method is based on the Laplace transform, which we define mathematically in Section 12.1. Before doing so, we need to explain why another analytical technique is needed. First, we wish to consider the transient behavior of circuits whose describing equations consist of more than a single node-voltage or mesh-current differential equation. In other words, we want to consider multiple-node and multiple-mesh circuits that are described by sets of linear differential equations.

Second, we wish to determine the transient response of circuits whose signal sources vary in ways more complicated than the simple dc level jumps considered in Chapters 7 and 8. Third, we can use the Laplace transform to introduce the concept of the transfer function as a tool for analyzing the steady-state sinusoidal response of a circuit when the frequency of the sinusoidal source is varied. We discuss the transfer function in Chapter 13. Finally, we wish to relate, in a systematic fashion, the time-domain behavior of a circuit to its frequency-domain behavior. Using the Laplace transform will provide a broader understanding of circuit functions.

In this chapter, we introduce the Laplace transform, discuss its pertinent characteristics, and present a systematic method for transforming from the frequency domain to the time domain.



## Practical Perspective

### Transient Effects

As we learned in Chapter 9, power delivered from electrical wall outlets in the U.S. can be modeled as a sinusoidal voltage or current source, where the frequency of the sinusoid is 60 Hz. The phasor concepts introduced in Chapter 9 allowed us to analyze the steady-state response of a circuit to a sinusoidal source.

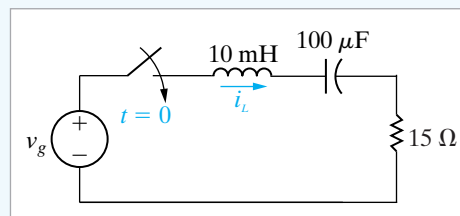
It is often important to pay attention to the complete response of a circuit to a sinusoidal source. Remember that the complete response has two parts—the steady-state response that takes the same form as the input to the circuit, and the transient response that decays to zero as time progresses. When the source for a circuit is modeled as a 60 Hz sinusoid, the steady-state response is also a 60 Hz sinusoid whose magnitude and phase angle can be calculated using phasor circuit analysis. The transient response depends on the components that make up the circuit, the values of those components, and the way the components are interconnected. The voltage and current for every component in a circuit is the sum of a transient part and a steady-state part, once the source is switched into the circuit.

While the transient part of the voltage and current eventually decays to zero, initially this transient part, when added to the steady-state part, may exceed the voltage or current rating of the circuit component. This is why it is important to be able to determine the complete response of a circuit. The Laplace transform techniques introduced in this chapter can be used to find the complete response of a circuit to a sinusoidal source.

Consider the *RLC* circuit shown below, comprised of components from Appendix H and powered by a 60 Hz sinusoidal source. As detailed in Appendix H, the 10 mH inductor has a current rating of 40 mA. The amplitude of the sinusoidal source has been chosen so that this rating is met in the steady state (see Problem 12.54). Once we have presented the Laplace transform method, we will be able to determine whether or not this current rating is exceeded when the source is first switched on and both the transient and steady-state components of the inductor current are active.



nrt / Shutterstock



## 12.1 Definition of the Laplace Transform

The **Laplace transform** of a function is given by the expression

Laplace transform ►

$$\mathcal{L}\{f(t)\} = \int_0^{\infty} f(t)e^{-st} dt, \quad (12.1)$$

where the symbol  $\mathcal{L}\{f(t)\}$  is read “the Laplace transform of  $f(t)$ .”

The Laplace transform of  $f(t)$  is also denoted  $F(s)$ ; that is,

$$F(s) = \mathcal{L}\{f(t)\}. \quad (12.2)$$

This notation emphasizes that when the integral in Eq. 12.1 has been evaluated, the resulting expression is a function of  $s$ . In our applications,  $t$  represents the time domain, and, because the exponent of  $e$  in the integral of Eq. 12.1 must be dimensionless,  $s$  must have the dimension of reciprocal time, or frequency. The Laplace transform transforms the problem from the time domain to the frequency domain. After obtaining the frequency-domain expression for the unknown, we inverse-transform it back to the time domain.

If the idea behind the Laplace transform seems foreign, consider another familiar mathematical transform. Logarithms are used to change a multiplication or division problem, such as  $A = BC$ , into a simpler addition or subtraction problem:  $\log A = \log BC = \log B + \log C$ . Antilogs are used to carry out the inverse process. The phasor is another transform; as we know from Chapter 9, it converts a sinusoidal signal into a complex number for easier, algebraic computation of circuit values. After determining the phasor value of a signal, we transform it back to its time-domain expression. Both of these examples point out the essential feature of mathematical transforms: They are designed to create a new domain to make the mathematical manipulations easier. After finding the unknown in the new domain, we inverse-transform it back to the original domain. In circuit analysis, we use the Laplace transform to transform a set of integrodifferential equations from the time domain to a set of algebraic equations in the frequency domain. We therefore simplify the solution for an unknown quantity to the manipulation of a set of algebraic equations.

Before we illustrate some of the important properties of the Laplace transform, some general comments are in order. First, note that the integral in Eq. 12.1 is improper because the upper limit is infinite. Thus we are confronted immediately with the question of whether the integral converges. In other words, does a given  $f(t)$  have a Laplace transform? Obviously, the functions of primary interest in engineering analysis have Laplace transforms; otherwise we would not be interested in the transform. In linear circuit analysis, we excite circuits with sources that have Laplace transforms. Excitation functions such as  $t^t$  or  $e^{t^2}$ , which do not have Laplace transforms, are of no interest here.

Second, because the lower limit on the integral is zero, the Laplace transform ignores  $f(t)$  for negative values of  $t$ . Put another way,  $F(s)$  is determined by the behavior of  $f(t)$  only for positive values of  $t$ . To emphasize that the lower limit is zero, Eq. 12.1 is frequently referred to as the **one-sided**, or **unilateral**, **Laplace transform**. In the two-sided, or bilateral, Laplace transform, the lower limit is  $-\infty$ . We do not use the bilateral form here; hence  $F(s)$  is understood to be the one-sided transform.

Another point regarding the lower limit concerns the situation when  $f(t)$  has a discontinuity at the origin. If  $f(t)$  is continuous at the origin—as,

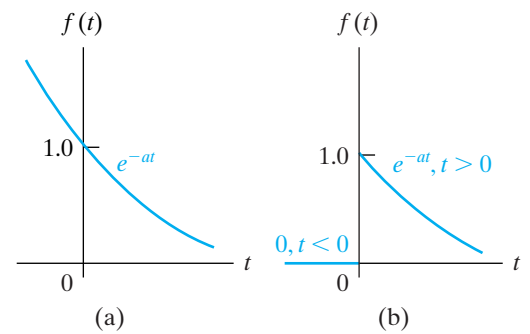


for example, in Fig. 12.1(a)— $f(0)$  is not ambiguous. However, if  $f(t)$  has a finite discontinuity at the origin—as, for example, in Fig. 12.1(b)—the question arises as to whether the Laplace transform integral should include or exclude the discontinuity. In other words, should we make the lower limit  $0^-$  and include the discontinuity, or should we exclude the discontinuity by making the lower limit  $0^+$ ? (We use the notation  $0^-$  and  $0^+$  to denote values of  $t$  just to the left and right of the origin, respectively.) Actually, we may choose either as long as we are consistent. For reasons to be explained later, we choose  $0^-$  as the lower limit.

Because we are using  $0^-$  as the lower limit, we note immediately that the integration from  $0^-$  to  $0^+$  is zero. The only exception is when the discontinuity at the origin is an impulse function, a situation we discuss in Section 12.3. The important point now is that the two functions shown in Fig. 12.1 have the same unilateral Laplace transform because there is no impulse function at the origin.

The one-sided Laplace transform ignores  $f(t)$  for  $t < 0^-$ . What happens prior to  $0^-$  is accounted for by the initial conditions. Thus we use the Laplace transform to predict the response to a disturbance that occurs after initial conditions have been established.

In the discussion that follows, we divide the Laplace transforms into two types: functional transforms and operational transforms. A **functional transform** is the Laplace transform of a specific function, such as  $\sin \omega t$ ,  $t$ ,  $e^{-at}$ , and so on. An **operational transform** defines a general mathematical property of the Laplace transform, such as finding the transform of the derivative of  $f(t)$ . Before considering functional and operational transforms, however, we need to introduce the step and impulse functions.



**Figure 12.1** ▲ A continuous and discontinuous function at the origin. (a)  $f(t)$  is continuous at the origin. (b)  $f(t)$  is discontinuous at the origin.

## 12.2 The Step Function

We may encounter functions that have a discontinuity, or jump, at the origin. For example, we know from earlier discussions of transient behavior that switching operations create abrupt changes in currents and voltages. We accommodate these discontinuities mathematically by introducing the step and impulse functions.

Figure 12.2 illustrates the step function. It is zero for  $t < 0$ . The symbol for the step function is  $Ku(t)$ . Thus, the mathematical definition of the **step function** is

$$\begin{aligned} Ku(t) &= 0, & t < 0, \\ Ku(t) &= K, & t > 0. \end{aligned} \tag{12.3}$$

If  $K$  is 1, the function defined by Eq. 12.3 is the **unit step**.

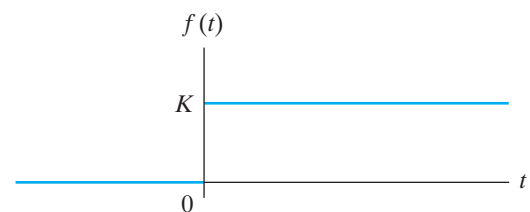
The step function is not defined at  $t = 0$ . In situations where we need to define the transition between  $0^-$  and  $0^+$ , we assume that it is linear and that

$$Ku(0) = 0.5K. \tag{12.4}$$

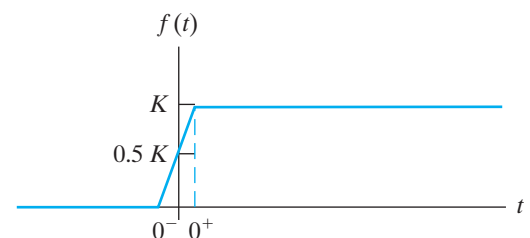
As before,  $0^-$  and  $0^+$  represent symmetric points arbitrarily close to the left and right of the origin. Figure 12.3 illustrates the linear transition from  $0^-$  to  $0^+$ .

A discontinuity may occur at some time other than  $t = 0$ ; for example, in sequential switching. A step that occurs at  $t = a$  is expressed as  $Ku(t - a)$ . Thus

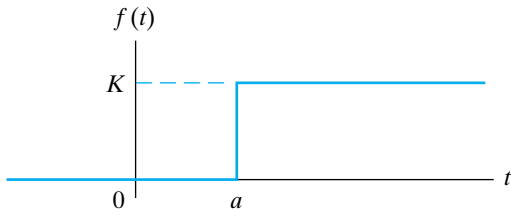
$$\begin{aligned} Ku(t - a) &= 0, & t < a, \\ Ku(t - a) &= K, & t > a. \end{aligned} \tag{12.5}$$



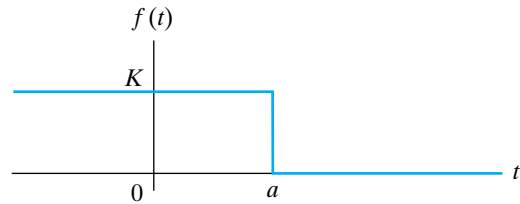
**Figure 12.2** ▲ The step function.



**Figure 12.3** ▲ The linear approximation to the step function.



**Figure 12.4** ▲ A step function occurring at  $t = a$  when  $a > 0$ .



**Figure 12.5** ▲ A step function  $Ku(a - t)$  for  $a > 0$ .

If  $a > 0$ , the step occurs to the right of the origin, and if  $a < 0$ , the step occurs to the left of the origin. Figure 12.4 illustrates Eq. 12.5. Note that the step function is 0 when the argument  $t - a$  is negative, and it is  $K$  when the argument is positive.

A step function equal to  $K$  for  $t < a$  is written as  $Ku(a - t)$ . Thus

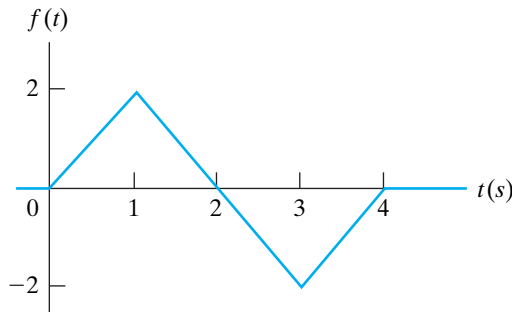
$$\begin{aligned} Ku(a - t) &= K, & t < a, \\ Ku(a - t) &= 0, & t > a. \end{aligned} \tag{12.6}$$

The discontinuity is to the left of the origin when  $a < 0$ . Equation 12.6 is shown in Fig. 12.5.

One application of the step function is to use it to write the mathematical expression for a function that is nonzero for a finite duration but is defined for all positive time. One example useful in circuit analysis is a finite-width pulse, which we can create by adding two step functions. The function  $K[u(t - 1) - u(t - 3)]$  has the value  $K$  for  $1 < t < 3$  and the value 0 everywhere else, so it is a finite-width pulse of height  $K$  initiated at  $t = 1$  and terminated at  $t = 3$ . In defining this pulse using step functions, it is helpful to think of the step function  $u(t - 1)$  as “turning on” the constant value  $K$  at  $t = 1$ , and the step function  $-u(t - 3)$  as “turning off” the constant value  $K$  at  $t = 3$ . We use step functions to turn on and turn off linear functions at desired times in Example 12.1.

**Example 12.1** Using Step Functions to Represent a Function of Finite Duration

Use step functions to write an expression for the function illustrated in Fig. 12.6.



**Figure 12.6** ▲ The function for Example 12.1.

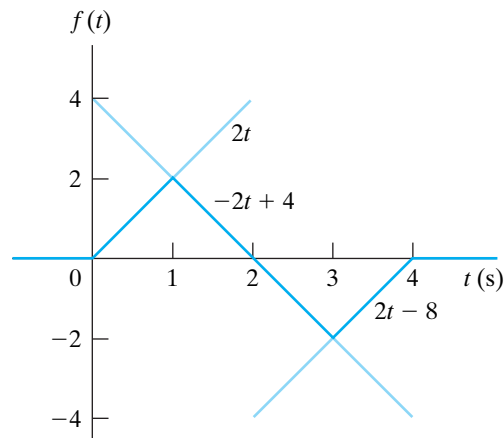
**Solution**

The function shown in Fig. 12.6 is made up of linear segments with break points at 0, 1, 3, and 4 s. To construct this function, we must add and subtract linear functions of the proper slope. We use the step function to initiate and terminate these linear segments at the proper times. In other words, we use the step function to turn on and turn off a straight line with the following equations:  $+2t$ , on at  $t = 0$ , off at  $t = 1$ ;  $-2t + 4$ , on at  $t = 1$ , off at  $t = 3$ ; and

*NOTE:* Assess your understanding of step functions by trying Chapter Problems 12.3 and 12.4.

$+2t - 8$ , on at  $t = 3$ , off at  $t = 4$ . These straight line segments and their equations are shown in Fig. 12.7. The expression for  $f(t)$  is

$$\begin{aligned} f(t) &= 2t[u(t) - u(t - 1)] + (-2t + 4)[u(t - 1) \\ &\quad - u(t - 3)] + (2t - 8)[u(t - 3) - u(t - 4)]. \end{aligned}$$



**Figure 12.7** ▲ Definition of the three line segments turned on and off with step functions to form the function shown in Fig. 12.6.

## 12.3 The Impulse Function

When we have a finite discontinuity in a function, such as that illustrated in Fig. 12.1(b), the derivative of the function is not defined at the point of the discontinuity. The concept of an impulse function<sup>1</sup> enables us to define the derivative at a discontinuity, and thus to define the Laplace transform of that derivative. An **impulse** is a signal of infinite amplitude and zero duration. Such signals don't exist in nature, but some circuit signals come very close to approximating this definition, so we find a mathematical model of an impulse useful. Impulsive voltages and currents occur in circuit analysis either because of a switching operation or because the circuit is excited by an impulsive source. We will analyze these situations in Chapter 13, but here we focus on defining the impulse function generally.

To define the derivative of a function at a discontinuity, we first assume that the function varies linearly across the discontinuity, as shown in Fig. 12.8, where we observe that as  $\epsilon \rightarrow 0$ , an abrupt discontinuity occurs at the origin. When we differentiate the function, the derivative between  $-\epsilon$  and  $+\epsilon$  is constant at a value of  $1/2\epsilon$ . For  $t > \epsilon$ , the derivative is  $-ae^{-a(t-\epsilon)}$ . Figure 12.9 shows these observations graphically. As  $\epsilon$  approaches zero, the value of  $f'(t)$  between  $\pm\epsilon$  approaches infinity. At the same time, the duration of this large value is approaching zero. Furthermore, the area under  $f'(t)$  between  $\pm\epsilon$  remains constant as  $\epsilon \rightarrow 0$ . In this example, the area is unity. As  $\epsilon$  approaches zero, we say that the function between  $\pm\epsilon$  approaches a **unit impulse function**, denoted  $\delta(t)$ . Thus the derivative of  $f(t)$  at the origin approaches a unit impulse function as  $\epsilon$  approaches zero, or

$$f'(0) \rightarrow \delta(t) \quad \text{as } \epsilon \rightarrow 0.$$

If the area under the impulse function curve is other than unity, the impulse function is denoted  $K\delta(t)$ , where  $K$  is the area.  $K$  is often referred to as the **strength** of the impulse function.

To summarize, an impulse function is created from a variable-parameter function whose parameter approaches zero. The variable-parameter function must exhibit the following three characteristics as the parameter approaches zero:

1. The amplitude approaches infinity.
2. The duration of the function approaches zero.
3. The area under the variable-parameter function is constant as the parameter changes.

Many different variable-parameter functions have the aforementioned characteristics. In Fig. 12.8, we used a linear function  $f(t) = 0.5t/\epsilon + 0.5$ . Another example of a variable-parameter function is the exponential function:

$$f(t) = \frac{K}{2\epsilon} e^{-|t|/\epsilon}. \quad (12.7)$$

As  $\epsilon$  approaches zero, the function becomes infinite at the origin and at the same time decays to zero in an infinitesimal length of time. Figure 12.10 illustrates the character of  $f(t)$  as  $\epsilon \rightarrow 0$ . To show that an impulse function

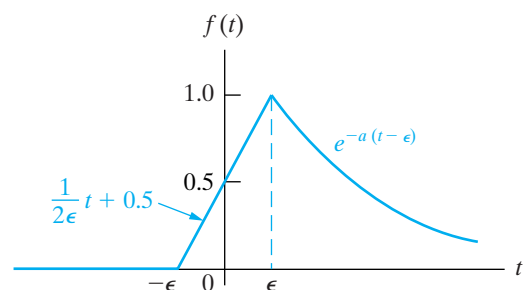


Figure 12.8 ▲ A magnified view of the discontinuity in Fig. 12.1(b), assuming a linear transition between  $-\epsilon$  and  $+\epsilon$ .

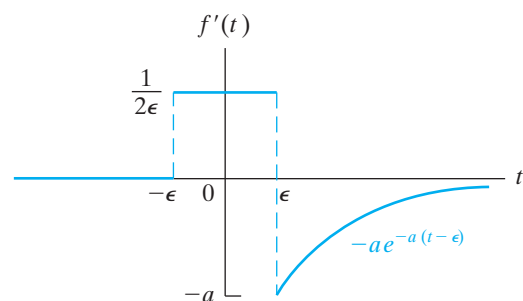


Figure 12.9 ▲ The derivative of the function shown in Fig. 12.8.

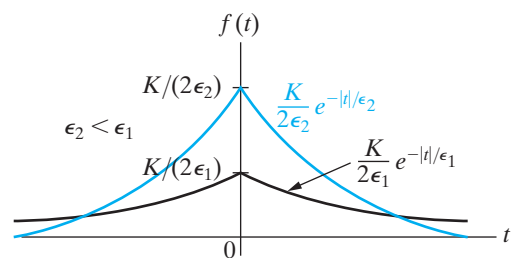


Figure 12.10 ▲ A variable-parameter function used to generate an impulse function.

<sup>1</sup> The impulse function is also known as the Dirac delta function.

is created as  $\epsilon \rightarrow 0$ , we must also show that the area under the function is independent of  $\epsilon$ . Thus,

$$\begin{aligned} \text{Area} &= \int_{-\infty}^0 \frac{K}{2\epsilon} e^{t/\epsilon} dt + \int_0^{\infty} \frac{K}{2\epsilon} e^{-t/\epsilon} dt \\ &= \frac{K}{2\epsilon} \cdot \frac{e^{t/\epsilon}}{1/\epsilon} \Big|_{-\infty}^0 + \frac{K}{2\epsilon} \cdot \frac{e^{-t/\epsilon}}{-1/\epsilon} \Big|_0^{\infty} \\ &= \frac{K}{2} + \frac{K}{2} = K, \end{aligned} \tag{12.8}$$

which tells us that the area under the curve is constant and equal to  $K$  units. Therefore, as  $\epsilon \rightarrow 0$ ,  $f(t) \rightarrow K\delta(t)$ .

Mathematically, the **impulse function** is defined

$$\int_{-\infty}^{\infty} K\delta(t)dt = K; \tag{12.9}$$

$$\delta(t) = 0, \quad t \neq 0. \tag{12.10}$$

Equation 12.9 states that the area under the impulse function is constant. This area represents the strength of the impulse. Equation 12.10 states that the impulse is zero everywhere except at  $t = 0$ . An impulse that occurs at  $t = a$  is denoted  $K\delta(t - a)$ .

The graphic symbol for the impulse function is an arrow. The strength of the impulse is given parenthetically next to the head of the arrow. Figure 12.11 shows the impulses  $K\delta(t)$  and  $K\delta(t - a)$ .

An important property of the impulse function is the **sifting property**, which is expressed as

$$\int_{-\infty}^{\infty} f(t)\delta(t - a)dt = f(a), \tag{12.11}$$

where the function  $f(t)$  is assumed to be continuous at  $t = a$ ; that is, at the location of the impulse. Equation 12.11 shows that the impulse function sifts out everything except the value of  $f(t)$  at  $t = a$ . The validity of Eq. 12.11 follows from noting that  $\delta(t - a)$  is zero everywhere except at  $t = a$ , and hence the integral can be written

$$I = \int_{-\infty}^{\infty} f(t)\delta(t - a)dt = \int_{a-\epsilon}^{a+\epsilon} f(t)\delta(t - a)dt. \tag{12.12}$$

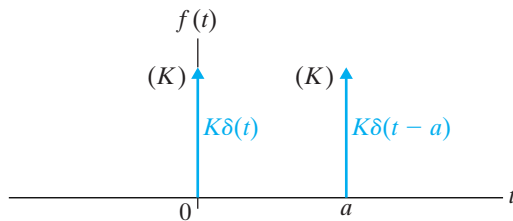
But because  $f(t)$  is continuous at  $a$ , it takes on the value  $f(a)$  as  $t \rightarrow a$ , so

$$\begin{aligned} I &= \int_{a-\epsilon}^{a+\epsilon} f(a)\delta(t - a)dt = f(a) \int_{a-\epsilon}^{a+\epsilon} \delta(t - a)dt \\ &= f(a). \end{aligned} \tag{12.13}$$

We use the sifting property of the impulse function to find its Laplace transform:

$$\mathcal{L}\{\delta(t)\} = \int_0^{\infty} \delta(t)e^{-st} dt = \int_0^{\infty} \delta(t)dt = 1, \tag{12.14}$$

which is an important Laplace transform pair that we make good use of in circuit analysis.



**Figure 12.11** ▲ A graphic representation of the impulse  $K\delta(t)$  and  $K\delta(t - a)$ .

We can also define the derivatives of the impulse function and the Laplace transform of these derivatives. We discuss the first derivative, along with its transform and then state the result for the higher-order derivatives.

The function illustrated in Fig. 12.12(a) generates an impulse function as  $\epsilon \rightarrow 0$ . Figure 12.12(b) shows the derivative of this impulse-generating function, which is defined as the derivative of the impulse  $[\delta'(t)]$  as  $\epsilon \rightarrow 0$ . The derivative of the impulse function sometimes is referred to as a moment function, or unit doublet.

To find the Laplace transform of  $\delta'(t)$ , we simply apply the defining integral to the function shown in Fig. 12.12(b) and, after integrating, let  $\epsilon \rightarrow 0$ . Then

$$\begin{aligned} L\{\delta'(t)\} &= \lim_{\epsilon \rightarrow 0} \left[ \int_{-\epsilon}^{0^-} \frac{1}{\epsilon^2} e^{-st} dt + \int_{0^+}^{\epsilon} \left(-\frac{1}{\epsilon^2}\right) e^{-st} dt \right] \\ &= \lim_{\epsilon \rightarrow 0} \frac{e^{s\epsilon} + e^{-s\epsilon} - 2}{s\epsilon^2} \\ &= \lim_{\epsilon \rightarrow 0} \frac{se^{s\epsilon} - se^{-s\epsilon}}{2\epsilon s} \\ &= \lim_{\epsilon \rightarrow 0} \frac{s^2 e^{s\epsilon} + s^2 e^{-s\epsilon}}{2s} \\ &= s. \end{aligned} \quad (12.15)$$

In deriving Eq. 12.15, we had to use l'Hôpital's rule twice to evaluate the indeterminate form  $0/0$ .

Higher-order derivatives may be generated in a manner similar to that used to generate the first derivative (see Problem 12.6), and the defining integral may then be used to find its Laplace transform. For the  $n$ th derivative of the impulse function, we find that its Laplace transform simply is  $s^n$ ; that is,

$$\mathcal{L}\{\delta^{(n)}(t)\} = s^n. \quad (12.16)$$

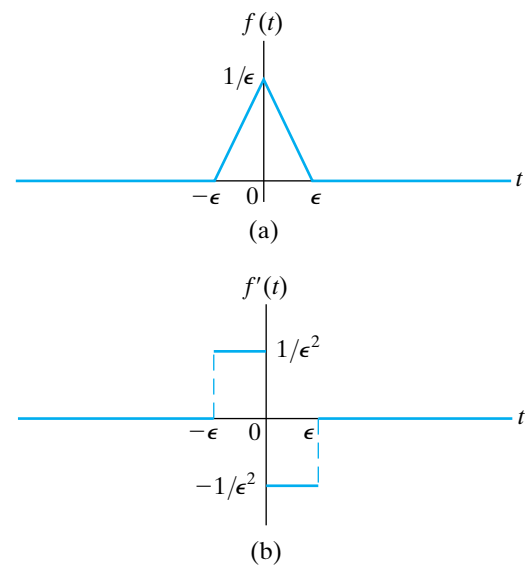
Finally, an impulse function can be thought of as a derivative of a step function; that is,

$$\delta(t) = \frac{du(t)}{dt}. \quad (12.17)$$

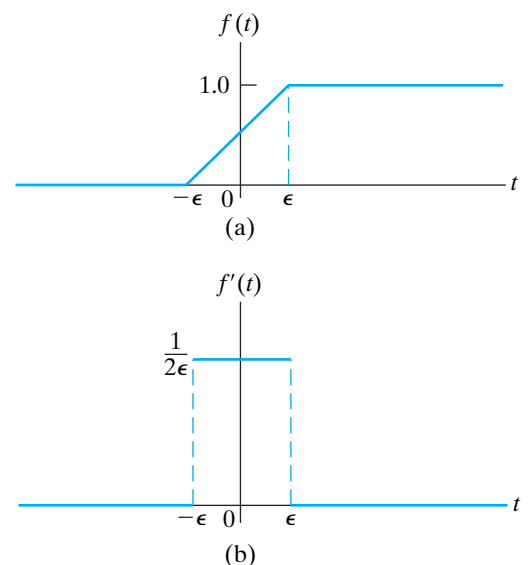
Figure 12.13 presents the graphic interpretation of Eq. 12.17. The function shown in Fig. 12.13(a) approaches a unit step function as  $\epsilon \rightarrow 0$ . The function shown in Fig. 12.13(b)—the derivative of the function in Fig. 12.13(a)—approaches a unit impulse as  $\epsilon \rightarrow 0$ .

The impulse function is an extremely useful concept in circuit analysis, and we say more about it in the following chapters. We introduced the concept here so that we can include discontinuities at the origin in our definition of the Laplace transform.

*NOTE:* Assess your understanding of the impulse function by trying Chapter Problems 12.6, 12.8, and 12.10.



**Figure 12.12** ▲ The first derivative of the impulse function. (a) The impulse-generating function used to define the first derivative of the impulse. (b) The first derivative of the impulse-generating function that approaches  $\delta'(t)$  as  $\epsilon \rightarrow 0$ .



**Figure 12.13** ▲ The impulse function as the derivative of the step function: (a)  $f(t) \rightarrow u(t)$  as  $\epsilon \rightarrow 0$ ; and (b)  $f'(t) \rightarrow \delta(t)$  as  $\epsilon \rightarrow 0$ .

## 12.4 Functional Transforms

A functional transform is simply the Laplace transform of a specified function of  $t$ . Because we are limiting our introduction to the unilateral, or one-sided, Laplace transform, we define all functions to be zero for  $t < 0^-$ .

We derived one functional transform pair in Section 12.3, where we showed that the Laplace transform of the unit impulse function equals 1; (see Eq. 12.14). A second illustration is the unit step function of Fig. 12.13(a), where

$$\begin{aligned} \mathcal{L}\{u(t)\} &= \int_{0^-}^{\infty} f(t)e^{-st} dt = \int_{0^+}^{\infty} 1e^{-st} dt \\ &= \left. \frac{e^{-st}}{-s} \right|_{0^+}^{\infty} = \frac{1}{s}. \end{aligned} \tag{12.18}$$

Equation 12.18 shows that the Laplace transform of the unit step function is  $1/s$ .

The Laplace transform of the decaying exponential function shown in Fig. 12.14 is

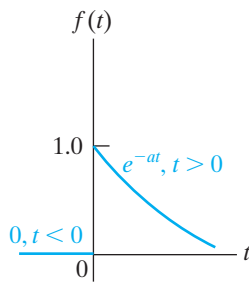


Figure 12.14 ▲ A decaying exponential function.

$$\mathcal{L}\{e^{-at}\} = \int_{0^+}^{\infty} e^{-at} e^{-st} dt = \int_{0^+}^{\infty} e^{-(a+s)t} dt = \frac{1}{s + a}. \tag{12.19}$$

In deriving Eqs. 12.18 and 12.19, we used the fact that integration across the discontinuity at the origin is zero.

A third illustration of finding a functional transform is the sinusoidal function shown in Fig. 12.15. The expression for  $f(t)$  for  $t > 0^-$  is  $\sin \omega t$ ; hence the Laplace transform is

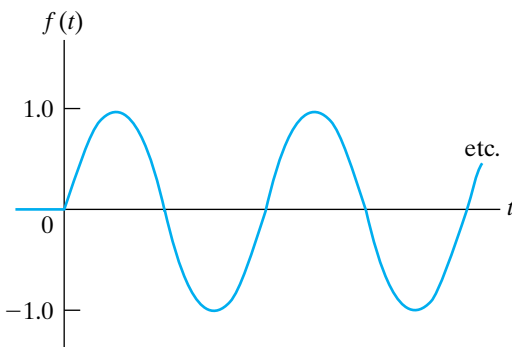


Figure 12.15 ▲ A sinusoidal function for  $t > 0$ .

$$\begin{aligned} \mathcal{L}\{\sin \omega t\} &= \int_{0^-}^{\infty} (\sin \omega t)e^{-st} dt \\ &= \int_{0^-}^{\infty} \left( \frac{e^{j\omega t} - e^{-j\omega t}}{2j} \right) e^{-st} dt \\ &= \int_{0^-}^{\infty} \frac{e^{-(s-j\omega)t} - e^{-(s+j\omega)t}}{2j} dt \\ &= \frac{1}{2j} \left( \frac{1}{s - j\omega} - \frac{1}{s + j\omega} \right) \\ &= \frac{\omega}{s^2 + \omega^2}. \end{aligned} \tag{12.20}$$

Table 12.1 gives an abbreviated list of Laplace transform pairs. It includes the functions of most interest in an introductory course on circuit applications.

TABLE 12.1 An Abbreviated List of Laplace Transform Pairs

Type	$f(t)$ ( $t > 0^-$ )	$F(s)$
(impulse)	$\delta(t)$	1
(step)	$u(t)$	$\frac{1}{s}$
(ramp)	$t$	$\frac{1}{s^2}$
(exponential)	$e^{-at}$	$\frac{1}{s+a}$
(sine)	$\sin \omega t$	$\frac{\omega}{s^2 + \omega^2}$
(cosine)	$\cos \omega t$	$\frac{s}{s^2 + \omega^2}$
(damped ramp)	$te^{-at}$	$\frac{1}{(s+a)^2}$
(damped sine)	$e^{-at} \sin \omega t$	$\frac{\omega}{(s+a)^2 + \omega^2}$
(damped cosine)	$e^{-at} \cos \omega t$	$\frac{s+a}{(s+a)^2 + \omega^2}$

### ✓ ASSESSMENT PROBLEM

**Objective 1**—Be able to calculate the Laplace transform of a function using the definition of Laplace transform

**12.1** Use the defining integral to

- a) find the Laplace transform of  $\cosh \beta t$ ;  
 b) find the Laplace transform of  $\sinh \beta t$ .

**Answer:** (a)  $s/(s^2 - \beta^2)$ ;

(b)  $\beta/(s^2 - \beta^2)$ .

*NOTE:* Also try Chapter Problem 12.20.

## 12.5 Operational Transforms

Operational transforms indicate how mathematical operations performed on either  $f(t)$  or  $F(s)$  are converted into the opposite domain. The operations of primary interest are (1) multiplication by a constant; (2) addition (subtraction); (3) differentiation; (4) integration; (5) translation in the time domain; (6) translation in the frequency domain; and (7) scale changing.

### Multiplication by a Constant

From the defining integral, if

$$\mathcal{L}\{f(t)\} = F(s),$$

then

$$\mathcal{L}\{Kf(t)\} = KF(s). \quad (12.21)$$

Thus, multiplication of  $f(t)$  by a constant corresponds to multiplying  $F(s)$  by the same constant.



### Addition (Subtraction)

Addition (subtraction) in the time domain translates into addition (subtraction) in the frequency domain. Thus if

$$\mathcal{L}\{f_1(t)\} = F_1(s),$$

$$\mathcal{L}\{f_2(t)\} = F_2(s),$$

$$\mathcal{L}\{f_3(t)\} = F_3(s),$$

then

$$\mathcal{L}\{f_1(t) + f_2(t) - f_3(t)\} = F_1(s) + F_2(s) - F_3(s), \quad (12.22)$$

which is derived by simply substituting the algebraic sum of time-domain functions into the defining integral.

### Differentiation

Differentiation in the time domain corresponds to multiplying  $F(s)$  by  $s$  and then subtracting the initial value of  $f(t)$ —that is,  $f(0^-)$ —from this product:

$$\mathcal{L}\left\{\frac{df(t)}{dt}\right\} = sF(s) - f(0^-), \quad (12.23)$$

which is obtained directly from the definition of the Laplace transform, or

$$\mathcal{L}\left\{\frac{df(t)}{dt}\right\} = \int_{0^-}^{\infty} \left[\frac{df(t)}{dt}\right] e^{-st} dt. \quad (12.24)$$

We evaluate the integral in Eq. 12.24 by integrating by parts. Letting  $u = e^{-st}$  and  $dv = [df(t)/dt] dt$  yields

$$\mathcal{L}\left\{\frac{df(t)}{dt}\right\} = e^{-st}f(t)\Big|_{0^-}^{\infty} - \int_{0^-}^{\infty} f(t)(-se^{-st}dt). \quad (12.25)$$

Because we are assuming that  $f(t)$  is Laplace transformable, the evaluation of  $e^{-st}f(t)$  at  $t = \infty$  is zero. Therefore the right-hand side of Eq. 12.25 reduces to

$$-f(0^-) + s \int_{0^-}^{\infty} f(t)e^{-st} dt = sF(s) - f(0^-).$$

This observation completes the derivation of Eq. 12.23. It is an important result because it states that differentiation in the time domain reduces to an algebraic operation in the  $s$  domain.

We determine the Laplace transform of higher-order derivatives by using Eq. 12.23 as the starting point. For example, to find the Laplace transform of the second derivative of  $f(t)$ , we first let

$$g(t) = \frac{df(t)}{dt}. \quad (12.26)$$

Now we use Eq. 12.23 to write

$$G(s) = sF(s) - f(0^-). \quad (12.27)$$

But because

$$\frac{dg(t)}{dt} = \frac{d^2f(t)}{dt^2},$$

we write

$$\mathcal{L}\left\{\frac{dg(t)}{dt}\right\} = \mathcal{L}\left\{\frac{d^2f(t)}{dt^2}\right\} = sG(s) - g(0^-). \quad (12.28)$$

Combining Eqs. 12.26, 12.27, and 12.28 gives

$$\mathcal{L}\left\{\frac{d^2f(t)}{dt^2}\right\} = s^2F(s) - sf(0^-) - \frac{df(0^-)}{dt}. \quad (12.29)$$

We find the Laplace transform of the  $n$ th derivative by successively applying the preceding process, which leads to the general result

$$\begin{aligned} \mathcal{L}\left\{\frac{d^n f(t)}{dt^n}\right\} &= s^n F(s) - s^{n-1}f(0^-) - s^{n-2}\frac{df(0^-)}{dt} \\ &\quad - s^{n-3}\frac{d^2f(0^-)}{dt^2} - \dots - \frac{d^{n-1}f(0^-)}{dt^{n-1}}. \end{aligned} \quad (12.30)$$

## Integration

Integration in the time domain corresponds to dividing by  $s$  in the  $s$  domain. As before, we establish the relationship by the defining integral:

$$\mathcal{L}\left\{\int_{0^-}^t f(x) dx\right\} = \int_{0^-}^{\infty} \left[\int_{0^-}^t f(x) dx\right] e^{-st} dt. \quad (12.31)$$

We evaluate the integral on the right-hand side of Eq. 12.31 by integrating by parts, first letting

$$u = \int_{0^-}^t f(x) dx,$$

$$dv = e^{-st} dt.$$

Then

$$du = f(t) dt,$$

$$v = -\frac{e^{-st}}{s}.$$

The integration-by-parts formula yields

$$\mathcal{L}\left\{\int_{0^-}^t f(x) dx\right\} = -\frac{e^{-st}}{s} \int_{0^-}^t f(x) dx \Big|_{0^-}^{\infty} + \int_{0^-}^{\infty} \frac{e^{-st}}{s} f(t) dt. \quad (12.32)$$

The first term on the right-hand side of Eq. 12.32 is zero at both the upper and lower limits. The evaluation at the lower limit obviously is zero, whereas the evaluation at the upper limit is zero because we are assuming that  $f(t)$  has a Laplace transform. The second term on the right-hand side of Eq. 12.32 is  $F(s)/s$ ; therefore

$$\mathcal{L}\left\{\int_{0^-}^t f(x) dx\right\} = \frac{F(s)}{s}, \quad (12.33)$$

which reveals that the operation of integration in the time domain is transformed to the algebraic operation of multiplying by  $1/s$  in the  $s$  domain. Equation 12.33 and Eq. 12.30 form the basis of the earlier statement that the Laplace transform translates a set of integrodifferential equations into a set of algebraic equations.

### Translation in the Time Domain

If we start with any function  $f(t)u(t)$ , we can represent the same function, translated in time by the constant  $a$ , as  $f(t-a)u(t-a)$ <sup>2</sup>. Translation in the time domain corresponds to multiplication by an exponential in the frequency domain. Thus

$$\mathcal{L}\{f(t-a)u(t-a)\} = e^{-as}F(s), \quad a > 0. \quad (12.34)$$

For example, knowing that

$$\mathcal{L}\{tu(t)\} = \frac{1}{s^2},$$

Eq. 12.34 permits writing the Laplace transform of  $(t-a)u(t-a)$  directly:

$$\mathcal{L}\{(t-a)u(t-a)\} = \frac{e^{-as}}{s^2}.$$

The proof of Eq. 12.34 follows from the defining integral:

$$\begin{aligned} \mathcal{L}\{(t-a)u(t-a)\} &= \int_{0^-}^{\infty} u(t-a)f(t-a)e^{-st} dt \\ &= \int_a^{\infty} f(t-a)e^{-st} dt. \end{aligned} \quad (12.35)$$

In writing Eq. 12.35, we took advantage of  $u(t-a) = 1$  for  $t > a$ . Now we change the variable of integration. Specifically, we let  $x = t - a$ . Then

<sup>2</sup> Note that throughout we multiply any arbitrary function  $f(t)$  by the unit step function  $u(t)$  to ensure that the resulting function is defined for all positive time.

$x = 0$  when  $t = a$ ,  $x = \infty$  when  $t = \infty$  and  $dx = dt$ . Thus we write the integral in Eq. 12.35 as

$$\begin{aligned}\mathcal{L}\{f(t-a)u(t-a)\} &= \int_0^{\infty} f(x)e^{-s(x+a)} dx \\ &= e^{-sa} \int_0^{\infty} f(x)e^{-sx} dx \\ &= e^{-as}F(s),\end{aligned}$$

which is what we set out to prove.

## Translation in the Frequency Domain

Translation in the frequency domain corresponds to multiplication by an exponential in the time domain:

$$\mathcal{L}\{e^{-at}f(t)\} = F(s+a), \quad (12.36)$$

which follows from the defining integral. The derivation of Eq. 12.36 is left to Problem 12.15.

We may use the relationship in Eq. 12.36 to derive new transform pairs. Thus, knowing that

$$\mathcal{L}\{\cos \omega t\} = \frac{s}{s^2 + \omega^2},$$

we use Eq. 12.36 to deduce that

$$\mathcal{L}\{e^{-at} \cos \omega t\} = \frac{s+a}{(s+a)^2 + \omega^2}.$$

## Scale Changing

The scale-change property gives the relationship between  $f(t)$  and  $F(s)$  when the time variable is multiplied by a positive constant:

$$\mathcal{L}\{f(at)\} = \frac{1}{a}F\left(\frac{s}{a}\right), \quad a > 0, \quad (12.37)$$

the derivation of which is left to Problem 12.16. The scale-change property is particularly useful in experimental work, especially where time-scale changes are made to facilitate building a model of a system.

We use Eq. 12.37 to formulate new transform pairs. Thus, knowing that

$$\mathcal{L}\{\cos t\} = \frac{s}{s^2 + 1},$$

we deduce from Eq. 12.37 that

$$\mathcal{L}\{\cos \omega t\} = \frac{1}{\omega} \frac{s/\omega}{(s/\omega)^2 + 1} = \frac{s}{s^2 + \omega^2}.$$

Table 12.2 gives an abbreviated list of operational transforms.

**TABLE 12.2 An Abbreviated List of Operational Transforms**

Operation	$f(t)$	$F(s)$
Multiplication by a constant	$Kf(t)$	$KF(s)$
Addition/subtraction	$f_1(t) + f_2(t) - f_3(t) + \dots$	$F_1(s) + F_2(s) - F_3(s) + \dots$
First derivative (time)	$\frac{df(t)}{dt}$	$sF(s) - f(0^-)$
Second derivative (time)	$\frac{d^2f(t)}{dt^2}$	$s^2F(s) - sf(0^-) - \frac{df(0^-)}{dt}$
$n$ th derivative (time)	$\frac{d^nf(t)}{dt^n}$	$s^nF(s) - s^{n-1}f(0^-) - s^{n-2}\frac{df(0^-)}{dt} - s^{n-3}\frac{df^2(0^-)}{dt^2} - \dots - \frac{d^{n-1}f(0^-)}{dt^{n-1}}$
Time integral	$\int_0^t f(x) dx$	$\frac{F(s)}{s}$
Translation in time	$f(t - a)u(t - a), a > 0$	$e^{-as}F(s)$
Translation in frequency	$e^{-at}f(t)$	$F(s + a)$
Scale changing	$f(at), a > 0$	$\frac{1}{a}F\left(\frac{s}{a}\right)$
First derivative (s)	$tf(t)$	$-\frac{dF(s)}{ds}$
$n$ th derivative (s)	$t^n f(t)$	$(-1)^n \frac{d^n F(s)}{ds^n}$
s integral	$\frac{f(t)}{t}$	$\int_s^\infty F(u) du$

**ASSESSMENT PROBLEM**

**Objective 1—Be able to calculate the Laplace transform of a function using the Laplace transform table or a table of operational transforms**

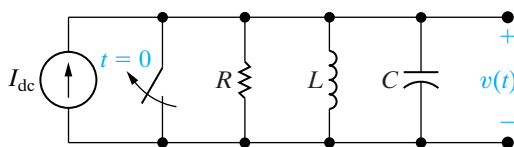
**12.2** Use the appropriate operational transform from Table 12.2 to find the Laplace transform of each function:

- a)  $t^2 e^{-at}$ ;
- b)  $\frac{d}{dt}(e^{-at} \sinh \beta t)$ ;
- c)  $t \cos \omega t$ .

- Answer:** (a)  $\frac{2}{(s + a)^3}$ ;
- (b)  $\frac{\beta s}{(s + a)^2 - \beta^2}$ ;
- (c)  $\frac{s^2 - \omega^2}{(s^2 + \omega^2)^2}$ .

*NOTE: Also try Chapter Problems 12.18 and 12.22.*

## 12.6 Applying the Laplace Transform



**Figure 12.16** ▲ A parallel RLC circuit.

We now illustrate how to use the Laplace transform to solve the ordinary integrodifferential equations that describe the behavior of lumped-parameter circuits. Consider the circuit shown in Fig. 12.16. We assume that no initial energy is stored in the circuit at the instant when the switch, which is shorting the dc current source, is opened. The problem is to find the time-domain expression for  $v(t)$  when  $t \geq 0$ .

We begin by writing the integrodifferential equation that  $v(t)$  must satisfy. We need only a single node-voltage equation to describe the circuit. Summing the currents away from the top node in the circuit generates the equation:

$$\frac{v(t)}{R} + \frac{1}{L} \int_0^t v(x) dx + C \frac{dv(t)}{dt} = I_{\text{dc}} u(t). \quad (12.38)$$

Note that in writing Eq. 12.38, we indicated the opening of the switch in the step jump of the source current from zero to  $I_{\text{dc}}$ .

After deriving the integrodifferential equations (in this example, just one), we transform the equations to the  $s$  domain. We will not go through the steps of the transformation in detail, because in Chapter 13 we will discover how to bypass them and generate the  $s$ -domain equations directly. Briefly though, we use three operational transforms and one functional transform on Eq. 12.38 to obtain

$$\frac{V(s)}{R} + \frac{1}{L} \frac{V(s)}{s} + C[sV(s) - v(0^-)] = I_{\text{dc}} \left( \frac{1}{s} \right), \quad (12.39)$$

an algebraic equation in which  $V(s)$  is the unknown variable. We are assuming that the circuit parameters  $R$ ,  $L$ , and  $C$ , as well as the source current  $I_{\text{dc}}$ , are known; the initial voltage on the capacitor  $v(0^-)$  is zero because the initial energy stored in the circuit is zero. Thus we have reduced the problem to solving an algebraic equation.

Next we solve the algebraic equations (again, just one in this case) for the unknowns. Solving Eq. 12.39 for  $V(s)$  gives

$$V(s) \left( \frac{1}{R} + \frac{1}{sL} + sC \right) = \frac{I_{\text{dc}}}{s},$$

$$V(s) = \frac{I_{\text{dc}}/C}{s^2 + (1/RC)s + (1/LC)}. \quad (12.40)$$

To find  $v(t)$  we must inverse-transform the expression for  $V(s)$ . We denote this inverse operation

$$v(t) = \mathcal{L}^{-1}\{V(s)\}. \quad (12.41)$$

The next step in the analysis is to find the inverse transform of the  $s$ -domain expression; this is the subject of Section 12.7. In that section we also present a final, critical step: checking the validity of the resulting time-domain expression. The need for such checking is not unique to the Laplace transform; conscientious and prudent engineers always test any derived solution to be sure it makes sense in terms of known system behavior.

Simplifying the notation now is advantageous. We do so by dropping the parenthetical  $t$  in time-domain expressions and the parenthetical  $s$  in frequency-domain expressions. We use lowercase letters for all time-domain

variables, and we represent the corresponding  $s$ -domain variables with uppercase letters. Thus

$$\mathcal{L}\{v\} = V \quad \text{or} \quad v = \mathcal{L}^{-1}\{V\},$$

$$\mathcal{L}\{i\} = I \quad \text{or} \quad i = \mathcal{L}^{-1}\{I\},$$

$$\mathcal{L}\{f\} = F \quad \text{or} \quad f = \mathcal{L}^{-1}\{F\},$$

and so on.

*NOTE: Assess your understanding of this material by trying Chapter Problem 12.26.*

## 12.7 Inverse Transforms

The expression for  $V(s)$  in Eq. 12.40 is a **rational** function of  $s$ ; that is, one that can be expressed in the form of a ratio of two polynomials in  $s$  such that no nonintegral powers of  $s$  appear in the polynomials. In fact, for linear, lumped-parameter circuits whose component values are constant, the  $s$ -domain expressions for the unknown voltages and currents are always rational functions of  $s$ . (You may verify this observation by working Problems 12.27–12.30.) If we can inverse-transform rational functions of  $s$ , we can solve for the time-domain expressions for the voltages and currents. The purpose of this section is to present a straight-forward and systematic technique for finding the inverse transform of a rational function.

In general, we need to find the inverse transform of a function that has the form

$$F(s) = \frac{N(s)}{D(s)} = \frac{a_n s^n + a_{n-1} s^{n-1} + \cdots + a_1 s + a_0}{b_m s^m + b_{m-1} s^{m-1} + \cdots + b_1 s + b_0}. \quad (12.42)$$

The coefficients  $a$  and  $b$  are real constants, and the exponents  $m$  and  $n$  are positive integers. The ratio  $N(s)/D(s)$  is called a **proper rational function** if  $m > n$ , and an **improper rational function** if  $m \leq n$ . Only a proper rational function can be expanded as a sum of partial fractions. This restriction poses no problem, as we show at the end of this section.

### Partial Fraction Expansion: Proper Rational Functions

A proper rational function is expanded into a sum of partial fractions by writing a term or a series of terms for each root of  $D(s)$ . Thus  $D(s)$  must be in factored form before we can make a partial fraction expansion. For each distinct root of  $D(s)$ , a single term appears in the sum of partial fractions. For each multiple root of  $D(s)$  of multiplicity  $r$ , the expansion contains  $r$  terms. For example, in the rational function

$$\frac{s + 6}{s(s + 3)(s + 1)^2},$$

the denominator has four roots. Two of these roots are distinct—namely, at  $s = 0$  and  $s = -3$ . A multiple root of multiplicity 2 occurs at  $s = -1$ . Thus the partial fraction expansion of this function takes the form

$$\frac{s + 6}{s(s + 3)(s + 1)^2} \equiv \frac{K_1}{s} + \frac{K_2}{s + 3} + \frac{K_3}{(s + 1)^2} + \frac{K_4}{s + 1}. \quad (12.43)$$



The key to the partial fraction technique for finding inverse transforms lies in recognizing the  $f(t)$  corresponding to each term in the sum of partial fractions. From Table 12.1 you should be able to verify that

$$\begin{aligned} & \mathcal{L}^{-1} \left\{ \frac{s+6}{s(s+3)(s+1)^2} \right\} \\ &= (K_1 + K_2 e^{-3t} + K_3 t e^{-t} + K_4 e^{-t}) u(t). \end{aligned} \quad (12.44)$$

All that remains is to establish a technique for determining the coefficients ( $K_1, K_2, K_3, \dots$ ) generated by making a partial fraction expansion. There are four general forms this problem can take. Specifically, the roots of  $D(s)$  are either (1) real and distinct; (2) complex and distinct; (3) real and repeated; or (4) complex and repeated. Before we consider each situation in turn, a few general comments are in order.

We used the identity sign  $\equiv$  in Eq. 12.43 to emphasize that expanding a rational function into a sum of partial fractions establishes an identical equation. Thus both sides of the equation must be the same for all values of the variable  $s$ . Also, the identity relationship must hold when both sides are subjected to the same mathematical operation. These characteristics are pertinent to determining the coefficients, as we will see.

Be sure to verify that the rational function is proper. This check is important because nothing in the procedure for finding the various  $K$ s will alert you to nonsense results if the rational function is improper. We present a procedure for checking the  $K$ s, but you can avoid wasted effort by forming the habit of asking yourself, "Is  $F(s)$  a proper rational function?"

### Partial Fraction Expansion: Distinct Real Roots of $D(s)$

We first consider determining the coefficients in a partial fraction expansion when all the roots of  $D(s)$  are real and distinct. To find a  $K$  associated with a term that arises because of a distinct root of  $D(s)$ , we multiply both sides of the identity by a factor equal to the denominator beneath the desired  $K$ . Then when we evaluate both sides of the identity at the root corresponding to the multiplying factor, the right-hand side is always the desired  $K$ , and the left-hand side is always its numerical value. For example,

$$F(s) = \frac{96(s+5)(s+12)}{s(s+8)(s+6)} \equiv \frac{K_1}{s} + \frac{K_2}{s+8} + \frac{K_3}{s+6}. \quad (12.45)$$

To find the value of  $K_1$ , we multiply both sides by  $s$  and then evaluate both sides at  $s = 0$ :

$$\left. \frac{96(s+5)(s+12)}{(s+8)(s+6)} \right|_{s=0} \equiv K_1 + \left. \frac{K_2 s}{s+8} \right|_{s=0} + \left. \frac{K_3 s}{s+6} \right|_{s=0},$$

or

$$\frac{96(5)(12)}{8(6)} \equiv K_1 = 120. \quad (12.46)$$

To find the value of  $K_2$ , we multiply both sides by  $s+8$  and then evaluate both sides at  $s = -8$ :

$$\begin{aligned} & \left. \frac{96(s+5)(s+12)}{s(s+6)} \right|_{s=-8} \\ & \equiv \left. \frac{K_1(s+8)}{s} \right|_{s=-8} + K_2 + \left. \frac{K_3(s+8)}{(s+6)} \right|_{s=-8}, \end{aligned}$$

or

$$\frac{96(-3)(4)}{(-8)(-2)} = K_2 = -72. \quad (12.47)$$

Then  $K_3$  is

$$\left. \frac{96(s+5)(s+12)}{s(s+8)} \right|_{s=-6} = K_3 = 48. \quad (12.48)$$

From Eq. 12.45 and the  $K$  values obtained,

$$\frac{96(s+5)(s+12)}{s(s+8)(s+6)} \equiv \frac{120}{s} + \frac{48}{s+6} - \frac{72}{s+8}. \quad (12.49)$$

At this point, testing the result to protect against computational errors is a good idea. As we already mentioned, a partial fraction expansion creates an identity; thus both sides of Eq. 12.49 must be the same for all  $s$  values. The choice of test values is completely open; hence we choose values that are easy to verify. For example, in Eq. 12.49, testing at either  $-5$  or  $-12$  is attractive because in both cases the left-hand side reduces to zero. Choosing  $-5$  yields

$$\frac{120}{-5} + \frac{48}{1} - \frac{72}{3} = -24 + 48 - 24 = 0,$$

whereas testing  $-12$  gives

$$\frac{120}{-12} + \frac{48}{-6} - \frac{72}{-4} = -10 - 8 + 18 = 0.$$

Now confident that the numerical values of the various  $K$ s are correct, we proceed to find the inverse transform:

$$\mathcal{L}^{-1} \left\{ \frac{96(s+5)(s+12)}{s(s+8)(s+6)} \right\} = (120 + 48e^{-6t} - 72e^{-8t})u(t). \quad (12.50)$$

## ✓ ASSESSMENT PROBLEMS

**Objective 2**—Be able to calculate the inverse Laplace transform using partial fraction expansion and the Laplace transform table

**12.3** Find  $f(t)$  if

$$F(s) = \frac{6s^2 + 26s + 26}{(s+1)(s+2)(s+3)}.$$

**Answer:**  $f(t) = (3e^{-t} + 2e^{-2t} + e^{-3t})u(t)$ .

**12.4** Find  $f(t)$  if

$$F(s) = \frac{7s^2 + 63s + 134}{(s+3)(s+4)(s+5)}.$$

**Answer:**  $f(t) = (4e^{-3t} + 6e^{-4t} - 3e^{-5t})u(t)$ .

*NOTE:* Also try Chapter Problems 12.40(a) and (b).

### Partial Fraction Expansion: Distinct Complex Roots of $D(s)$

The only difference between finding the coefficients associated with distinct complex roots and finding those associated with distinct real roots is that the algebra in the former involves complex numbers. We illustrate by expanding the rational function:

$$F(s) = \frac{100(s+3)}{(s+6)(s^2+6s+25)}. \quad (12.51)$$

We begin by noting that  $F(s)$  is a proper rational function. Next we must find the roots of the quadratic term  $s^2 + 6s + 25$ :

$$s^2 + 6s + 25 = (s + 3 - j4)(s + 3 + j4). \quad (12.52)$$

With the denominator in factored form, we proceed as before:

$$\begin{aligned} \frac{100(s+3)}{(s+6)(s^2+6s+25)} &\equiv \\ &\frac{K_1}{s+6} + \frac{K_2}{s+3-j4} + \frac{K_3}{s+3+j4}. \end{aligned} \quad (12.53)$$

To find  $K_1$ ,  $K_2$ , and  $K_3$ , we use the same process as before:

$$K_1 = \left. \frac{100(s+3)}{s^2+6s+25} \right|_{s=-6} = \frac{100(-3)}{25} = -12, \quad (12.54)$$

$$\begin{aligned} K_2 &= \left. \frac{100(s+3)}{(s+6)(s+3+j4)} \right|_{s=-3+j4} = \frac{100(j4)}{(3+j4)(j8)} \\ &= 6 - j8 = 10e^{-j53.13^\circ}, \end{aligned} \quad (12.55)$$

$$\begin{aligned} K_3 &= \left. \frac{100(s+3)}{(s+6)(s+3-j4)} \right|_{s=-3-j4} = \frac{100(-j4)}{(3-j4)(-j8)} \\ &= 6 + j8 = 10e^{j53.13^\circ}. \end{aligned} \quad (12.56)$$

Then

$$\begin{aligned} \frac{100(s+3)}{(s+6)(s^2+6s+25)} &= \frac{-12}{s+6} + \frac{10\angle-53.13^\circ}{s+3-j4} \\ &\quad + \frac{10\angle53.13^\circ}{s+3+j4}. \end{aligned} \quad (12.57)$$

Again, we need to make some observations. First, in physically realizable circuits, complex roots always appear in conjugate pairs. Second, the coefficients associated with these conjugate pairs are themselves conjugates. Note, for example, that  $K_3$  (Eq. 12.56) is the conjugate of  $K_2$

(Eq. 12.55). Thus for complex conjugate roots, you actually need to calculate only half the coefficients.

Before inverse-transforming Eq. 12.57, we check the partial fraction expansion numerically. Testing at  $-3$  is attractive because the left-hand side reduces to zero at this value:

$$\begin{aligned} F(s) &= \frac{-12}{3} + \frac{10 \angle -53.13^\circ}{-j4} + \frac{10 \angle 53.13^\circ}{j4} \\ &= -4 + 2.5 \angle 36.87^\circ + 2.5 \angle -36.87^\circ \\ &= -4 + 2.0 + j1.5 + 2.0 - j1.5 = 0. \end{aligned}$$

We now proceed to inverse-transform Eq. 12.57:

$$\begin{aligned} \mathcal{L}^{-1} \left\{ \frac{100(s+3)}{(s+6)(s^2+6s+25)} \right\} &= (-12e^{-6t} + 10e^{-j53.13^\circ} e^{-(3-j4)t} \\ &\quad + 10e^{j53.13^\circ} e^{-(3+j4)t})u(t). \end{aligned} \quad (12.58)$$

In general, having the function in the time domain contain imaginary components is undesirable. Fortunately, because the terms involving imaginary components always come in conjugate pairs, we can eliminate the imaginary components simply by adding the pairs:

$$\begin{aligned} 10e^{-j53.13^\circ} e^{-(3-j4)t} + 10e^{j53.13^\circ} e^{-(3+j4)t} \\ &= 10e^{-3t}(e^{j(4t-53.13^\circ)} + e^{-j(4t-53.13^\circ)}) \\ &= 20e^{-3t} \cos(4t - 53.13^\circ), \end{aligned} \quad (12.59)$$

which enables us to simplify Eq. 12.58:

$$\begin{aligned} \mathcal{L}^{-1} \left\{ \frac{100(s+3)}{(s+6)(s^2+6s+25)} \right\} \\ &= [-12e^{-6t} + 20e^{-3t} \cos(4t - 53.13^\circ)]u(t). \end{aligned} \quad (12.60)$$

Because distinct complex roots appear frequently in lumped-parameter linear circuit analysis, we need to summarize these results with a new transform pair. Whenever  $D(s)$  contains distinct complex roots—that is, factors of the form  $(s + \alpha - j\beta)(s + \alpha + j\beta)$ —a pair of terms of the form

$$\frac{K}{s + \alpha - j\beta} + \frac{K^*}{s + \alpha + j\beta} \quad (12.61)$$

appears in the partial fraction expansion, where the partial fraction coefficient is, in general, a complex number. In polar form,

$$K = |K|e^{j\theta} = |K| \angle \theta^\circ, \quad (12.62)$$

where  $|K|$  denotes the magnitude of the complex coefficient. Then

$$K^* = |K|e^{-j\theta} = |K| \angle -\theta^\circ. \quad (12.63)$$

The complex conjugate pair in Eq. 12.61 always inverse-transforms as

$$\begin{aligned} \mathcal{L}^{-1} \left\{ \frac{K}{s + \alpha - j\beta} + \frac{K^*}{s + \alpha + j\beta} \right\} \\ = 2|K|e^{-\alpha t} \cos(\beta t + \theta). \end{aligned} \quad (12.64)$$

In applying Eq. 12.64 it is important to note that  $K$  is defined as the coefficient associated with the denominator term  $s + \alpha - j\beta$ , and  $K^*$  is defined as the coefficient associated with the denominator  $s + \alpha + j\beta$ .

### ✓ ASSESSMENT PROBLEM

**Objective 2**—Be able to calculate the inverse Laplace transform using partial fraction expansion and the Laplace transform table

**12.5** Find  $f(t)$  if

**Answer:**  $f(t) = (10e^{-5t} - 8.33e^{-5t} \sin 12t)u(t)$ .

$$F(s) = \frac{10(s^2 + 119)}{(s + 5)(s^2 + 10s + 169)}.$$

*NOTE:* Also try Chapter Problems 12.41(c) and (d).

### Partial Fraction Expansion: Repeated Real Roots of $D(s)$

To find the coefficients associated with the terms generated by a multiple root of multiplicity  $r$ , we multiply both sides of the identity by the multiple root raised to its  $r$ th power. We find the  $K$  appearing over the factor raised to the  $r$ th power by evaluating both sides of the identity at the multiple root. To find the remaining  $(r - 1)$  coefficients, we differentiate both sides of the identity  $(r - 1)$  times. At the end of each differentiation, we evaluate both sides of the identity at the multiple root. The right-hand side is always the desired  $K$ , and the left-hand side is always its numerical value. For example,

$$\frac{100(s + 25)}{s(s + 5)^3} = \frac{K_1}{s} + \frac{K_2}{(s + 5)^3} + \frac{K_3}{(s + 5)^2} + \frac{K_4}{s + 5}. \quad (12.65)$$

We find  $K_1$  as previously described; that is,

$$K_1 = \frac{100(s + 25)}{(s + 5)^3} \Big|_{s=0} = \frac{100(25)}{125} = 20. \quad (12.66)$$

To find  $K_2$ , we multiply both sides by  $(s + 5)^3$  and then evaluate both sides at  $-5$ :

$$\begin{aligned} \frac{100(s + 25)}{s} \Big|_{s=-5} &= \frac{K_1(s + 5)^3}{s} \Big|_{s=-5} + K_2 + K_3(s + 5) \Big|_{s=-5} \\ &\quad + K_4(s + 5)^2 \Big|_{s=-5}, \end{aligned} \quad (12.67)$$

$$\begin{aligned} \frac{100(20)}{(-5)} &= K_1 \times 0 + K_2 + K_3 \times 0 + K_4 \times 0 \\ &= K_2 = -400. \end{aligned} \quad (12.68)$$

To find  $K_3$  we first multiply both sides of Eq. 12.65 by  $(s + 5)^3$ . Next we differentiate both sides once with respect to  $s$  and then evaluate at  $s = -5$ :

$$\begin{aligned} \frac{d}{ds} \left[ \frac{100(s + 25)}{s} \right]_{s=-5} &= \frac{d}{ds} \left[ \frac{K_1(s + 5)^3}{s} \right]_{s=-5} \\ &+ \frac{d}{ds} [K_2]_{s=-5} \\ &+ \frac{d}{ds} [K_3(s + 5)]_{s=-5} \\ &+ \frac{d}{ds} [K_4(s + 5)^2]_{s=-5}, \end{aligned} \quad (12.69)$$

$$100 \left[ \frac{s - (s + 25)}{s^2} \right]_{s=-5} = K_3 = -100. \quad (12.70)$$

To find  $K_4$  we first multiply both sides of Eq. 12.65 by  $(s + 5)^3$ . Next we differentiate both sides twice with respect to  $s$  and then evaluate both sides at  $s = -5$ . After simplifying the first derivative, the second derivative becomes

$$\begin{aligned} 100 \frac{d}{ds} \left[ \frac{25}{s^2} \right]_{s=-5} &= K_1 \frac{d}{ds} \left[ \frac{(s + 5)^2(2s - 5)}{s^2} \right]_{s=-5} \\ &+ 0 + \frac{d}{ds} [K_3]_{s=-5} + \frac{d}{ds} [2K_4(s + 5)]_{s=-5}, \end{aligned}$$

or

$$-40 = 2K_4. \quad (12.71)$$

Solving Eq. 12.71 for  $K_4$  gives

$$K_4 = -20. \quad (12.72)$$

Then

$$\frac{100(s + 25)}{s(s + 5)^3} = \frac{20}{s} - \frac{400}{(s + 5)^3} - \frac{100}{(s + 5)^2} - \frac{20}{s + 5}. \quad (12.73)$$

At this point we can check our expansion by testing both sides of Eq. 12.73 at  $s = -25$ . Noting both sides of Eq. 12.73 equal zero when  $s = -25$  gives us confidence in the correctness of the partial fraction expansion. The inverse transform of Eq. 12.73 yields

$$\begin{aligned} \mathcal{L}^{-1} \left\{ \frac{100(s + 25)}{s(s + 5)^3} \right\} \\ = [20 - 200t^2e^{-5t} - 100te^{-5t} - 20e^{-5t}]u(t). \end{aligned} \quad (12.74)$$

### ✓ ASSESSMENT PROBLEM

**Objective 2**—Be able to calculate the inverse Laplace transform using partial fraction expansion and the Laplace transform table

**12.6** Find  $f(t)$  if

$$F(s) = \frac{(4s^2 + 7s + 1)}{s(s + 1)^2}.$$

**Answer:**  $f(t) = (1 + 2te^{-t} + 3e^{-t})u(t)$ .

*NOTE:* Also try Chapter Problems 12.41(a) and (b).

### Partial Fraction Expansion: Repeated Complex Roots of $D(s)$

We handle repeated complex roots in the same way that we did repeated real roots; the only difference is that the algebra involves complex numbers. Recall that complex roots always appear in conjugate pairs and that the coefficients associated with a conjugate pair are also conjugates, so that only half the  $K$ s need to be evaluated. For example,

$$F(s) = \frac{768}{(s^2 + 6s + 25)^2}. \quad (12.75)$$

After factoring the denominator polynomial, we write

$$\begin{aligned} F(s) &= \frac{768}{(s + 3 - j4)^2(s + 3 + j4)^2} \\ &= \frac{K_1}{(s + 3 - j4)^2} + \frac{K_2}{s + 3 - j4} \\ &\quad + \frac{K_1^*}{(s + 3 + j4)^2} + \frac{K_2^*}{s + 3 + j4}. \end{aligned} \quad (12.76)$$

Now we need to evaluate only  $K_1$  and  $K_2$ , because  $K_1^*$  and  $K_2^*$  are conjugate values. The value of  $K_1$  is

$$\begin{aligned} K_1 &= \left. \frac{768}{(s + 3 + j4)^2} \right|_{s=-3+j4} \\ &= \frac{768}{(j8)^2} = -12. \end{aligned} \quad (12.77)$$

The value of  $K_2$  is

$$\begin{aligned} K_2 &= \frac{d}{ds} \left[ \frac{768}{(s + 3 + j4)^2} \right]_{s=-3+j4} \\ &= -\frac{2(768)}{(s + 3 + j4)^3} \Big|_{s=-3+j4} \\ &= -\frac{2(768)}{(j8)^3} \\ &= -j3 = 3 \angle -90^\circ. \end{aligned} \quad (12.78)$$



From Eqs. 12.77 and 12.78,

$$K_1^* = -12, \quad (12.79)$$

$$K_2^* = j3 = 3 \angle 90^\circ. \quad (12.80)$$

We now group the partial fraction expansion by conjugate terms to obtain

$$F(s) = \left[ \frac{-12}{(s + 3 - j4)^2} + \frac{-12}{(s + 3 + j4)^2} \right] + \left( \frac{3 \angle -90^\circ}{s + 3 - j4} + \frac{3 \angle 90^\circ}{s + 3 + j4} \right). \quad (12.81)$$

We now write the inverse transform of  $F(s)$ :

$$f(t) = [-24te^{-3t} \cos 4t + 6e^{-3t} \cos(4t - 90^\circ)]u(t). \quad (12.82)$$

Note that if  $F(s)$  has a real root  $a$  of multiplicity  $r$  in its denominator, the term in a partial fraction expansion is of the form

$$\frac{K}{(s + a)^r}.$$

The inverse transform of this term is

$$\mathcal{L}^{-1} \left\{ \frac{K}{(s + a)^r} \right\} = \frac{Kt^{r-1}e^{-at}}{(r-1)!} u(t). \quad (12.83)$$

If  $F(s)$  has a complex root of  $\alpha + j\beta$  of multiplicity  $r$  in its denominator, the term in partial fraction expansion is the conjugate pair

$$\frac{K}{(s + \alpha - j\beta)^r} + \frac{K^*}{(s + \alpha + j\beta)^r}.$$

The inverse transform of this pair is

$$\begin{aligned} \mathcal{L}^{-1} \left\{ \frac{K}{(s + \alpha - j\beta)^r} + \frac{K^*}{(s + \alpha + j\beta)^r} \right\} \\ = \left[ \frac{2|K|t^{r-1}}{(r-1)!} e^{-\alpha t} \cos(\beta t + \theta) \right] u(t). \end{aligned} \quad (12.84)$$

Equations 12.83 and 12.84 are the key to being able to inverse-transform any partial fraction expansion by inspection. One further note regarding these two equations: In most circuit analysis problems,  $r$  is seldom greater than 2. Therefore, the inverse transform of a rational function can be handled with four transform pairs. Table 12.3 lists these pairs.

TABLE 12.3 Four Useful Transform Pairs

Pair Number	Nature of Roots	$F(s)$	$f(t)$
1	Distinct real	$\frac{K}{s+a}$	$Ke^{-at}u(t)$
2	Repeated real	$\frac{K}{(s+a)^2}$	$Kte^{-at}u(t)$
3	Distinct complex	$\frac{K}{s+\alpha-j\beta} + \frac{K^*}{s+\alpha+j\beta}$	$2 K e^{-\alpha t} \cos(\beta t + \theta)u(t)$
4	Repeated complex	$\frac{K}{(s+\alpha-j\beta)^2} + \frac{K^*}{(s+\alpha+j\beta)^2}$	$2t K e^{-\alpha t} \cos(\beta t + \theta)u(t)$

Note: In pairs 1 and 2,  $K$  is a real quantity, whereas in pairs 3 and 4,  $K$  is the complex quantity  $|K| \angle \theta$ .

### ASSESSMENT PROBLEM

**Objective 2**—Be able to calculate the inverse Laplace transform using partial fraction expansion and the Laplace transform table

12.7 Find  $f(t)$  if

$$F(s) = \frac{40}{(s^2 + 4s + 5)^2}$$

**Answer:**  $f(t) = (-20te^{-2t} \cos t + 20e^{-2t} \sin t)u(t)$ .

NOTE: Also try Chapter Problem 12.43(b).

## Partial Fraction Expansion: Improper Rational Functions

We conclude the discussion of partial fraction expansions by returning to an observation made at the beginning of this section, namely, that improper rational functions pose no serious problem in finding inverse transforms. An improper rational function can always be expanded into a polynomial plus a proper rational function. The polynomial is then inverse-transformed into impulse functions and derivatives of impulse functions. The proper rational function is inverse-transformed by the techniques outlined in this section. To illustrate the procedure, we use the function

$$F(s) = \frac{s^4 + 13s^3 + 66s^2 + 200s + 300}{s^2 + 9s + 20}. \quad (12.85)$$

Dividing the denominator into the numerator until the remainder is a proper rational function gives

$$F(s) = s^2 + 4s + 10 + \frac{30s + 100}{s^2 + 9s + 20}, \quad (12.86)$$

where the term  $(30s + 100)/(s^2 + 9s + 20)$  is the remainder.

Next we expand the proper rational function into a sum of partial fractions:

$$\frac{30s + 100}{s^2 + 9s + 20} = \frac{30s + 100}{(s+4)(s+5)} = \frac{-20}{s+4} + \frac{50}{s+5}. \quad (12.87)$$

Substituting Eq. 12.87 into Eq. 12.86 yields

$$F(s) = s^2 + 4s + 10 - \frac{20}{s+4} + \frac{50}{s+5}. \quad (12.88)$$

Now we can inverse-transform Eq. 12.88 by inspection. Hence

$$\begin{aligned} f(t) &= \frac{d^2\delta(t)}{dt^2} + 4\frac{d\delta(t)}{dt} + 10\delta(t) \\ &\quad - (20e^{-4t} - 50e^{-5t})u(t). \end{aligned} \quad (12.89)$$

## ✓ ASSESSMENT PROBLEMS

**Objective 2**—Be able to calculate the inverse Laplace transform using partial fraction expansion and the Laplace transform table

**12.8** Find  $f(t)$  if

$$F(s) = \frac{(5s^2 + 29s + 32)}{(s+2)(s+4)}.$$

**Answer:**  $f(t) = 5\delta(t) - (3e^{-2t} - 2e^{-4t})u(t)$ .

*NOTE:* Also try Chapter Problem 12.43(c).

**12.9** Find  $f(t)$  if

$$F(s) = \frac{(2s^3 + 8s^2 + 2s - 4)}{(s^2 + 5s + 4)}.$$

**Answer:**  $f(t) = 2\frac{d\delta(t)}{dt} - 2\delta(t) + 4e^{-4t}u(t)$ .

## 12.8 Poles and Zeros of $F(s)$

The rational function of Eq. 12.42 also may be expressed as the ratio of two factored polynomials. In other words, we may write  $F(s)$  as

$$F(s) = \frac{K(s+z_1)(s+z_2)\cdots(s+z_n)}{(s+p_1)(s+p_2)\cdots(s+p_m)}, \quad (12.90)$$

where  $K$  is the constant  $a_n/b_m$ . For example, we may also write the function

$$F(s) = \frac{8s^2 + 120s + 400}{2s^4 + 20s^3 + 70s^2 + 100s + 48}$$

as

$$\begin{aligned} F(s) &= \frac{8(s^2 + 15s + 50)}{2(s^4 + 10s^3 + 35s^2 + 50s + 24)} \\ &= \frac{4(s+5)(s+10)}{(s+1)(s+2)(s+3)(s+4)}. \end{aligned} \quad (12.91)$$

The roots of the denominator polynomial, that is,  $-p_1, -p_2, -p_3, \dots, -p_m$ , are called the **poles of  $F(s)$** ; they are the values of  $s$  at which  $F(s)$  becomes infinitely large. In the function described by Eq. 12.91, the poles of  $F(s)$  are  $-1, -2, -3$ , and  $-4$ .

The roots of the numerator polynomial, that is,  $-z_1, -z_2, -z_3, \dots, -z_n$ , are called the **zeros of  $F(s)$** ; they are the values of  $s$  at which  $F(s)$  becomes zero. In the function described by Eq. 12.91, the zeros of  $F(s)$  are  $-5$  and  $-10$ .

In what follows, you may find that being able to visualize the poles and zeros of  $F(s)$  as points on a complex  $s$  plane is helpful. A complex plane is needed because the roots of the polynomials may be complex. In the complex  $s$  plane, we use the horizontal axis to plot the real values of  $s$  and the vertical axis to plot the imaginary values of  $s$ .

As an example of plotting the poles and zeros of  $F(s)$ , consider the function

$$F(s) = \frac{10(s + 5)(s + 3 - j4)(s + 3 + j4)}{s(s + 10)(s + 6 - j8)(s + 6 + j8)}. \quad (12.92)$$

The poles of  $F(s)$  are at  $0, -10, -6 + j8$ , and  $-6 - j8$ . The zeros are at  $-5, -3 + j4$ , and  $-3 - j4$ . Figure 12.17 shows the poles and zeros plotted on the  $s$  plane, where X's represent poles and O's represent zeros.

Note that the poles and zeros for Eq. 12.90 are located in the finite  $s$  plane.  $F(s)$  can also have either an  $r$ th-order pole or an  $r$ th-order zero at infinity. For example, the function described by Eq. 12.91 has a second-order zero at infinity, because for large values of  $s$  the function reduces to  $4/s^2$ , and  $F(s) = 0$  when  $s = \infty$ . In this text, we are interested in the poles and zeros located in the finite  $s$  plane. Therefore, when we refer to the poles and zeros of a rational function of  $s$ , we are referring to the finite poles and zeros.

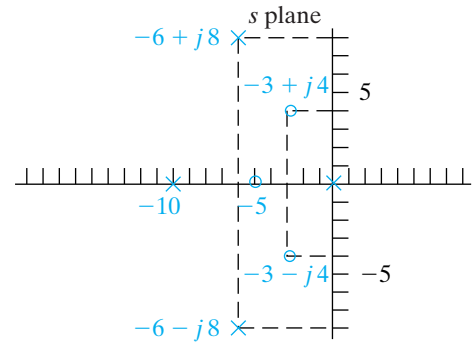


Figure 12.17 ▲ Plotting poles and zeros on the  $s$  plane.

## 12.9 Initial- and Final-Value Theorems

The initial- and final-value theorems are useful because they enable us to determine from  $F(s)$  the behavior of  $f(t)$  at  $0$  and  $\infty$ . Hence we can check the initial and final values of  $f(t)$  to see if they conform with known circuit behavior, before actually finding the inverse transform of  $F(s)$ .

The initial-value theorem states that

$$\lim_{t \rightarrow 0^+} f(t) = \lim_{s \rightarrow \infty} sF(s), \quad (12.93) \quad \blacktriangleleft \text{Initial value theorem}$$

and the final-value theorem states that

$$\lim_{t \rightarrow \infty} f(t) = \lim_{s \rightarrow 0} sF(s). \quad (12.94) \quad \blacktriangleleft \text{Final value theorem}$$

The initial-value theorem is based on the assumption that  $f(t)$  contains no impulse functions. In Eq. 12.94, we must add the restriction that the theorem is valid only if the poles of  $F(s)$ , except for a first-order pole at the origin, lie in the left half of the  $s$  plane.

To prove Eq. 12.93, we start with the operational transform of the first derivative:

$$\mathcal{L} \left\{ \frac{df}{dt} \right\} = sF(s) - f(0^-) = \int_{0^-}^{\infty} \frac{df}{dt} e^{-st} dt. \quad (12.95)$$

Now we take the limit as  $s \rightarrow \infty$ :

$$\lim_{s \rightarrow \infty} [sF(s) - f(0^-)] = \lim_{s \rightarrow \infty} \int_{0^-}^{\infty} \frac{df}{dt} e^{-st} dt. \quad (12.96)$$

Observe that the right-hand side of Eq. 12.96 may be written as

$$\lim_{s \rightarrow \infty} \left( \int_{0^-}^{0^+} \frac{df}{dt} e^0 dt + \int_{0^+}^{\infty} \frac{df}{dt} e^{-st} dt \right).$$

As  $s \rightarrow \infty$ ,  $(df/dt)e^{-st} \rightarrow 0$ ; hence the second integral vanishes in the limit. The first integral reduces to  $f(0^+) - f(0^-)$ , which is independent of  $s$ . Thus the right-hand side of Eq. 12.96 becomes

$$\lim_{s \rightarrow \infty} \int_{0^-}^{\infty} \frac{df}{dt} e^{-st} dt = f(0^+) - f(0^-). \quad (12.97)$$

Because  $f(0^-)$  is independent of  $s$ , the left-hand side of Eq. 12.96 may be written

$$\lim_{s \rightarrow \infty} [sF(s) - f(0^-)] = \lim_{s \rightarrow \infty} [sF(s)] - f(0^-). \quad (12.98)$$

From Eqs. 12.97 and 12.98,

$$\lim_{s \rightarrow \infty} sF(s) = f(0^+) = \lim_{t \rightarrow 0^+} f(t),$$

which completes the proof of the initial-value theorem.

The proof of the final-value theorem also starts with Eq. 12.95. Here we take the limit as  $s \rightarrow 0$ :

$$\lim_{s \rightarrow 0} [sF(s) - f(0^-)] = \lim_{s \rightarrow 0} \left( \int_{0^-}^{\infty} \frac{df}{dt} e^{-st} dt \right). \quad (12.99)$$

The integration is with respect to  $t$  and the limit operation is with respect to  $s$ , so the right-hand side of Eq. 12.99 reduces to

$$\lim_{s \rightarrow 0} \left( \int_{0^-}^{\infty} \frac{df}{dt} e^{-st} dt \right) = \int_{0^-}^{\infty} \frac{df}{dt} dt. \quad (12.100)$$

Because the upper limit on the integral is infinite, this integral may also be written as a limit process:

$$\int_{0^-}^{\infty} \frac{df}{dt} dt = \lim_{t \rightarrow \infty} \int_{0^-}^t \frac{df}{dy} dy, \quad (12.101)$$

where we use  $y$  as the symbol of integration to avoid confusion with the upper limit on the integral. Carrying out the integration process yields

$$\lim_{t \rightarrow \infty} [f(t) - f(0^-)] = \lim_{t \rightarrow \infty} [f(t)] - f(0^-). \quad (12.102)$$

Substituting Eq. 12.102 into Eq. 12.99 gives

$$\lim_{s \rightarrow 0} [sF(s)] - f(0^-) = \lim_{t \rightarrow \infty} [f(t)] - f(0^-). \quad (12.103)$$

Because  $f(0^-)$  cancels, Eq. 12.103 reduces to the final-value theorem, namely,

$$\lim_{s \rightarrow 0} sF(s) = \lim_{t \rightarrow \infty} f(t).$$

The final-value theorem is useful only if  $f(\infty)$  exists. This condition is true only if all the poles of  $F(s)$ , except for a simple pole at the origin, lie in the left half of the  $s$  plane.

## The Application of Initial- and Final-Value Theorems

To illustrate the application of the initial- and final-value theorems, we apply them to a function we used to illustrate partial fraction expansions. Consider the transform pair given by Eq. 12.60. The initial-value theorem gives

$$\lim_{s \rightarrow \infty} sF(s) = \lim_{s \rightarrow \infty} \frac{100s^2[1 + (3/s)]}{s^3[1 + (6/s)][1 + (6/s) + (25/s^2)]} = 0,$$

$$\lim_{t \rightarrow 0^+} f(t) = [-12 + 20 \cos(-53.13^\circ)](1) = -12 + 12 = 0.$$

The final-value theorem gives

$$\lim_{s \rightarrow 0} sF(s) = \lim_{s \rightarrow 0} \frac{100s(s + 3)}{(s + 6)(s^2 + 6s + 25)} = 0,$$

$$\lim_{t \rightarrow \infty} f(t) = \lim_{t \rightarrow \infty} [-12e^{-6t} + 20e^{-3t} \cos(4t - 53.13^\circ)]u(t) = 0.$$

In applying the theorems to Eq. 12.60, we already had the time-domain expression and were merely testing our understanding. But the real value of the initial- and final-value theorems lies in being able to test the  $s$ -domain expressions before working out the inverse transform. For example, consider the expression for  $V(s)$  given by Eq. 12.40. Although we cannot calculate  $v(t)$  until the circuit parameters are specified, we can check to see if  $V(s)$  predicts the correct values of  $v(0^+)$  and  $v(\infty)$ . We know from the statement of the problem that generated  $V(s)$  that  $v(0^+)$  is zero. We also know that  $v(\infty)$  must be zero because the ideal inductor is a perfect short circuit across the dc current source. Finally, we know that the poles of  $V(s)$  must lie in the left half of the  $s$  plane because  $R$ ,  $L$ , and  $C$  are positive constants. Hence the poles of  $sV(s)$  also lie in the left half of the  $s$  plane.

Applying the initial-value theorem yields

$$\lim_{s \rightarrow \infty} sV(s) = \lim_{s \rightarrow \infty} \frac{s(I_{dc}/C)}{s^2[1 + 1/(RCs) + 1/(LCs^2)]} = 0.$$

Applying the final-value theorem gives

$$\lim_{s \rightarrow 0} sV(s) = \lim_{s \rightarrow 0} \frac{s(I_{dc}/C)}{s^2 + (s/RC) + (1/LC)} = 0.$$

The derived expression for  $V(s)$  correctly predicts the initial and final values of  $v(t)$ .

### ✓ ASSESSMENT PROBLEM

**Objective 3—Understand and know how to use the initial value theorem and the final value theorem**

**12.10** Use the initial- and final-value theorems to find the initial and final values of  $f(t)$  in Assessment Problems 12.4, 12.6, and 12.7.

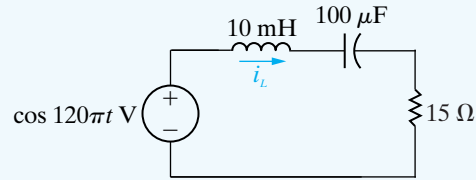
**Answer:** 7, 0; 4, 1; and 0, 0.

*NOTE:* Also try Chapter Problem 12.50.

## Practical Perspective

### Transient Effects

The circuit introduced in the Practical Perspective at the beginning of the chapter is repeated in Fig. 12.18 with the switch closed and the chosen sinusoidal source.



**Figure 12.18** ▲ A series  $RLC$  circuit with a 60 Hz sinusoidal source.

We use the Laplace methods to determine the complete response of the inductor current,  $i_L(t)$ . To begin, use KVL to sum the voltage drops around the circuit, in the clockwise direction:

$$15i_L(t) + 0.01\frac{di_L(t)}{dt} + \frac{1}{100 \times 10^{-6}} \int_0^t i_L(x)dx = \cos 120\pi t \quad (12.104)$$

Now we take the Laplace transform of Eq. 12.104, using Tables 12.1 and 12.2:

$$15I_L(s) + 0.01sI_L(s) + 10^4\frac{I_L(s)}{s} = \frac{s}{s^2 + (120\pi)^2} \quad (12.105)$$

Next, rearrange the terms in Eq. 12.105 to get an expression for  $I_L(s)$ :

$$I_L(s) = \frac{100s^2}{[s^2 + 1500s + 10^6][s^2 + (120\pi)^2]} \quad (12.106)$$

Note that the expression for  $I_L(s)$  has two complex conjugate pairs of poles, so the partial fraction expansion of  $I_L(s)$  will have four terms:

$$I_L(s) = \frac{K_1}{(s + 750 - j661.44)} + \frac{K_1^*}{(s + 750 + j661.44)} + \frac{K_2}{(s - j120\pi)} + \frac{K_2^*}{(s + j120\pi)} \quad (12.107)$$

Determine the values of  $K_1$  and  $K_2$ :

$$K_1 = \left. \frac{100s^2}{[s + 750s + j661.44][s^2 + (120\pi)^2]} \right|_{s=-750+j661.44} = 0.07357 \angle -97.89^\circ$$

$$K_2 = \left. \frac{100s^2}{[s^2 + 1500s + 10^6][s + j120\pi]} \right|_{s=j120\pi} = 0.018345 \angle 56.61^\circ \quad (12.108)$$

Finally, we can use Table 12.3 to calculate the inverse Laplace transform of Eq. 12.107 to give  $i_L(t)$ :

$$i_L(t) = 147.14e^{-750t} \cos(661.44t - 97.89^\circ) + 36.69 \cos(120\pi t + 56.61^\circ) \text{ mA} \quad (12.109)$$

The first term of Eq. 12.109 is the transient response, which will decay to essentially zero in about 7 ms. The second term of Eq. 12.109 is the steady-state response, which has the same frequency as the 60 Hz sinusoidal source and will persist so long as this source is connected in the circuit. Note that the amplitude of the steady-state response is 36.69 mA, which is less than the 40 mA current rating of the inductor. But the transient response has an



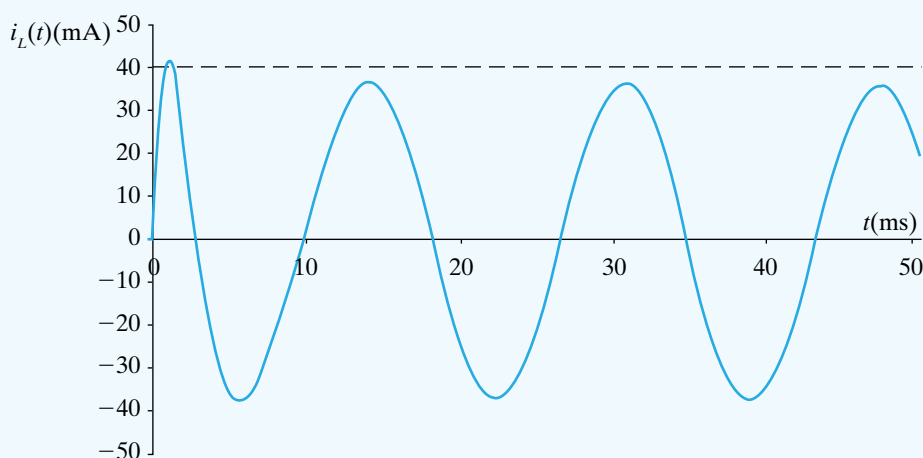
initial amplitude of 147.14 mA, far greater than the 40 mA current rating. Calculate the value of the inductor current at  $t = 0$ :

$$i_L(0) = 147.14(1)\cos(-97.89^\circ) + 36.69 \cos(56.61^\circ) = -6.21\mu\text{A}$$

Clearly, the transient part of the response does not cause the inductor current to exceed its rating initially. But we need a plot of the complete response to determine whether or not the current rating is ever exceeded, as shown in Fig. 12.19. The plot suggests we check the value of the inductor current at 1 ms:

$$i_L(0.001) = 147.14e^{-0.75} \cos(-59.82^\circ) + 36.69 \cos(78.21^\circ) = 42.6 \text{ mA}$$

Thus, the current rating is exceeded in the inductor, at least momentarily. If we determine that we never want to exceed the current rating, we should reduce the magnitude of the sinusoidal source. This example illustrates the importance of considering the complete response of a circuit to a sinusoidal input, even if we are satisfied with the steady-state response.



**Figure 12.19** ▲ Plot of the inductor current for the circuit in Fig. 12.18.

*NOTE: Access your understanding of the Practical Perspective by trying Chapter Problems 12.55 and 12.56.*

## Summary

- The **Laplace transform** is a tool for converting time-domain equations into frequency-domain equations, according to the following general definition:

$$\mathcal{L}\{f(t)\} = \int_0^{\infty} f(t)e^{-st} dt = F(s),$$

where  $f(t)$  is the time-domain expression, and  $F(s)$  is the frequency-domain expression. (See page 428.)

- The **step function**  $Ku(t)$  describes a function that experiences a discontinuity from one constant level to another at some point in time.  $K$  is the magnitude of the jump; if  $K = 1$ ,  $Ku(t)$  is the **unit step function**. (See page 429.)
- The **impulse function**  $K\delta(t)$  is defined

$$\int_{-\infty}^{\infty} K\delta(t)dt = K,$$

$$\delta(t) = 0, \quad t \neq 0.$$

$K$  is the strength of the impulse; if  $K = 1$ ,  $K\delta(t)$  is the **unit impulse function**. (See page 431.)

- A **functional transform** is the Laplace transform of a specific function. Important functional transform pairs are summarized in Table 12.1. (See page 434.)
- Operational transforms** define the general mathematical properties of the Laplace transform. Important operational transform pairs are summarized in Table 12.2. (See page 435.)
- In linear lumped-parameter circuits,  $F(s)$  is a rational function of  $s$ . (See page 442.)
- If  $F(s)$  is a proper rational function, the inverse transform is found by a partial fraction expansion. (See page 442.)
- If  $F(s)$  is an improper rational function, it can be inverse-transformed by first expanding it into a sum of a polynomial and a proper rational function. (See page 451.)

- $F(s)$  can be expressed as the ratio of two factored polynomials. The roots of the denominator are called **poles** and are plotted as Xs on the complex  $s$  plane. The roots of the numerator are called **zeros** and are plotted as Os on the complex  $s$  plane. (See page 452.)
- The initial-value theorem states that

$$\lim_{t \rightarrow 0^+} f(t) = \lim_{s \rightarrow \infty} sF(s).$$

The theorem assumes that  $f(t)$  contains no impulse functions. (See page 453.)

- The final-value theorem states that

$$\lim_{t \rightarrow \infty} f(t) = \lim_{s \rightarrow 0^+} sF(s).$$

The theorem is valid only if the poles of  $F(s)$ , except for a first-order pole at the origin, lie in the left half of the  $s$  plane. (See page 453.)

- The initial- and final-value theorems allow us to predict the initial and final values of  $f(t)$  from an  $s$ -domain expression. (See page 455.)

## Problems

### Section 12.2

- 12.1** Step functions can be used to define a *window* function. Thus  $u(t + 2) - u(t - 3)$  defines a window 1 unit high and 5 units wide located on the time axis between  $-2$  and  $3$ .

A function  $f(t)$  is defined as follows:

$$\begin{aligned} f(t) &= 0, & t \leq 0 \\ &= 5t, & 0 \leq t \leq 10 \text{ s} \\ &= -5t + 100, & 10 \text{ s} \leq t \leq 30 \text{ s} \\ &= -50, & 30 \text{ s} \leq t \leq 40 \text{ s}; \\ &= 2.5t - 150 & 40 \text{ s} \leq t \leq 60 \text{ s} \\ &= 0, & 60 \text{ s} \leq t < \infty. \end{aligned}$$

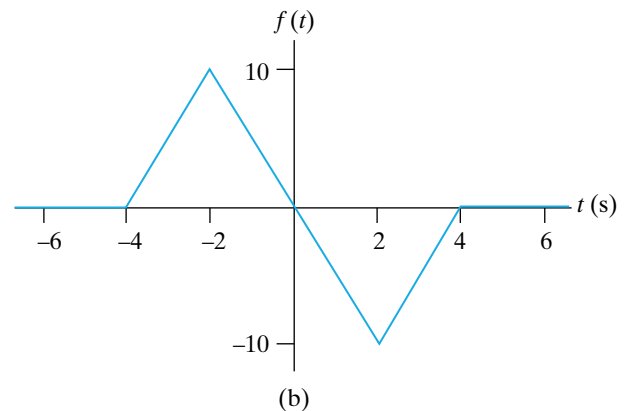
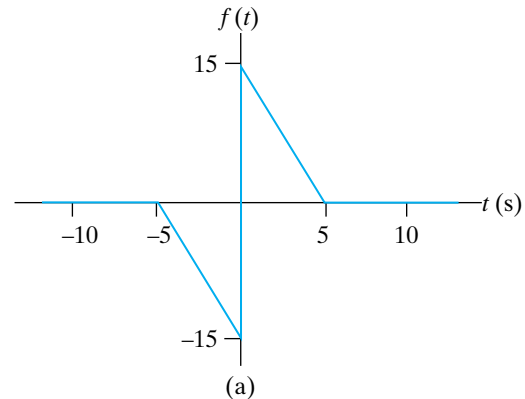
- Sketch  $f(t)$  over the interval  $0 \text{ s} \leq t \leq 60 \text{ s}$ .
- Use the concept of the window function to write an expression for  $f(t)$ .

- 12.2** Make a sketch of  $f(t)$  for  $-3 \text{ s} \leq t \leq 18 \text{ s}$  when  $f(t)$  is given by the following expression:

$$\begin{aligned} f(t) &= (-10t - 30)u(t + 3) + 10tu(t) \\ &\quad + (10t - 30)u(t - 3) \\ &\quad + (90 - 10t)u(t - 9) + (150 - 10t)u(t - 15) \\ &\quad + (10t - 180)u(t - 18) \end{aligned}$$

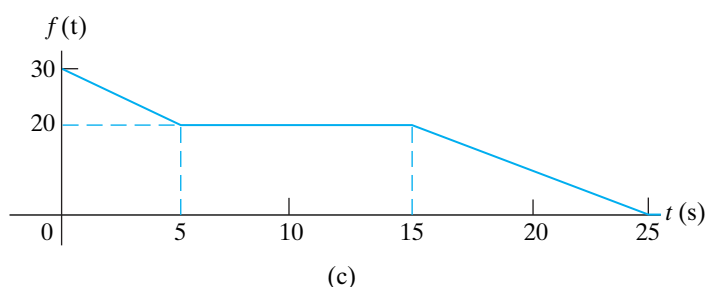
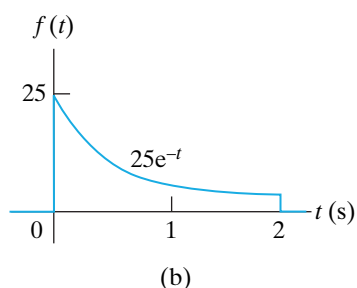
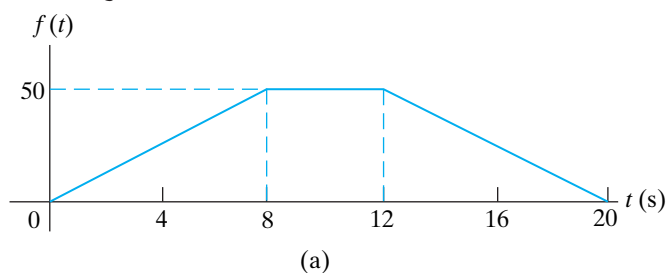
- 12.3** Use step functions to write the expression for each of the functions shown in Fig. P12.3.

Figure P12.3



- 12.4** Use step functions to write the expression for each function shown in Fig. P12.4.

Figure P12.4



## Section 12.3

**12.5** Explain why the following function generates an impulse function as  $\epsilon \rightarrow 0$ :

$$f(t) = \frac{\epsilon/\pi}{\epsilon^2 + t^2}, \quad -\infty \leq t \leq \infty.$$

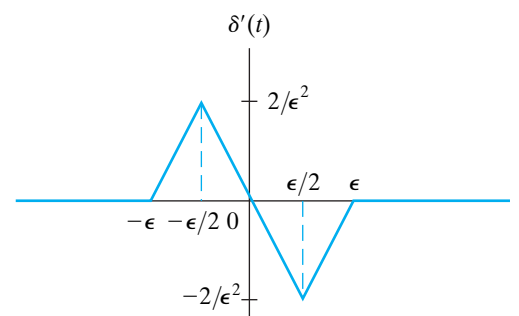
**12.6** a) Find the area under the function shown in Fig. 12.12(a).

b) What is the duration of the function when  $\epsilon = 0$ ?

c) What is the magnitude of  $f(0)$  when  $\epsilon = 0$ ?

**12.7** The triangular pulses shown in Fig. P12.7 are equivalent to the rectangular pulses in Fig. 12.12(b), because they both enclose the same area ( $1/\epsilon$ ) and they both approach infinity proportional to  $1/\epsilon^2$  as  $\epsilon \rightarrow 0$ . Use this triangular-pulse representation for  $\delta'(t)$  to find the Laplace transform of  $\delta''(t)$ .

Figure P12.7



**12.8** Evaluate the following integrals:

a)  $I = \int_{-1}^3 (t^3 + 2)[\delta(t) + 8\delta(t - 1)] dt.$

b)  $I = \int_{-2}^2 t^2[\delta(t) + \delta(t + 1.5) + \delta(t - 3)] dt.$

**12.9** In Section 12.3, we used the sifting property of the impulse function to show that  $\mathcal{L}\{\delta(t)\} = 1$ . Show that we can obtain the same result by finding the Laplace transform of the rectangular pulse that exists between  $\pm\epsilon$  in Fig. 12.9 and then finding the limit of this transform as  $\epsilon \rightarrow 0$ .

**12.10** Find  $f(t)$  if

$$f(t) = \frac{1}{2\pi} \int_{-\infty}^{\infty} F(\omega) e^{j\omega t} d\omega,$$

and

$$F(\omega) = \frac{4 + j\omega}{9 + j\omega} \pi \delta(\omega).$$

**12.11** Show that

$$\mathcal{L}\{\delta^{(n)}(t)\} = s^n.$$

**12.12** a) Show that

$$\int_{-\infty}^{\infty} f(t) \delta'(t - a) dt = -f'(a).$$

(Hint: Integrate by parts.)

b) Use the formula in (a) to show that

$$\mathcal{L}\{\delta'(t)\} = s.$$

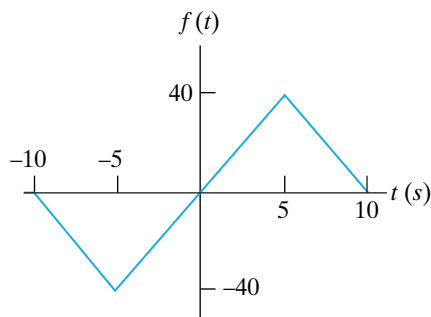
**Sections 12.4–12.5**

**12.13** Find the Laplace transform of each of the following functions:

- a)  $f(t) = 20e^{-500(t-10)}u(t - 10)$ .
- b)  $f(t) = (5t + 20)[u(t + 4) - u(t + 2)] - 5t[u(t + 2) - u(t - 2)] + (5t - 20)[u(t - 2) - u(t - 4)]$ .

- 12.14** a) Find the Laplace transform of the function illustrated in Fig. P12.14.  
 b) Find the Laplace transform of the first derivative of the function illustrated in Fig. P12.14.  
 c) Find the Laplace transform of the second derivative of the function illustrated in Fig. P12.14.

**Figure P12.14**



**12.15** Show that

$$\mathcal{L}\{e^{-at} f(t)\} = F(s + a).$$

**12.16** Show that

$$\mathcal{L}\{f(at)\} = \frac{1}{a} F\left(\frac{s}{a}\right).$$

- 12.17** a) Find the Laplace transform of  $te^{-at}$ .  
 b) Use the operational transform given by Eq. 12.23 to find the Laplace transform of  $\frac{d}{dt}(te^{-at})$ .  
 c) Check your result in part (b) by first differentiating and then transforming the resulting expression.

- 12.18** a) Find  $\mathcal{L}\left\{\int_{0^-}^t e^{-ax} dx\right\}$ .  
 b) Check the results of (a) by first integrating and then transforming.

**12.19** a) Find the Laplace transform of

$$\int_{0^-}^t x dx$$

by first integrating and then transforming.

- b) Check the result obtained in (a) by using the operational transform given by Eq. 12.33.

**12.20** Find the Laplace transform of each of the following functions:

- a)  $f(t) = te^{-at}$ ;
- b)  $f(t) = \sin \omega t$ ;
- c)  $f(t) = \sin(\omega t + \theta)$ ;
- d)  $f(t) = t$ ;
- e)  $f(t) = \cosh(t + \theta)$ .

(Hint: See Assessment Problem 12.1.)

**12.21** a) Given that  $F(s) = \mathcal{L}\{f(t)\}$ , show that

$$-\frac{dF(s)}{ds} = \mathcal{L}\{tf(t)\}.$$

b) Show that

$$(-1)^n \frac{d^n F(s)}{ds^n} = \mathcal{L}\{t^n f(t)\}.$$

- c) Use the result of (b) to find  $\mathcal{L}\{t^5\}$ ,  $\mathcal{L}\{t \sin \beta t\}$ , and  $\mathcal{L}\{te^{-t} \cosh t\}$ .

**12.22** a) Find  $\mathcal{L}\left\{\frac{d}{dt} \sin \omega t\right\}$ .

b) Find  $\mathcal{L}\left\{\frac{d}{dt} \cos \omega t\right\}$ .

c) Find  $\mathcal{L}\left\{\frac{d^3}{dt^3} t^2 u(t)\right\}$ .

d) Check the results of parts (a), (b), and (c) by first differentiating and then transforming.

**12.23** Find the Laplace transform (when  $\epsilon \rightarrow 0$ ) of the derivative of the exponential function illustrated in Fig. 12.8, using each of the following two methods:

- a) First differentiate the function and then find the transform of the resulting function.
- b) Use the operational transform given by Eq. 12.23.

**12.24** Find the Laplace transform for (a) and (b).

a)  $f(t) = \frac{d}{dt}(e^{-at} \cos \omega t)$ .

b)  $f(t) = \int_0^t e^{-ax} \sin \omega x dx$ .

c) Verify the results obtained in (a) and (b) by first carrying out the indicated mathematical operation and then finding the Laplace transform.

**12.25** a) Show that if  $F(s) = \mathcal{L}\{f(t)\}$ , and  $\{f(t)/t\}$  is Laplace-transformable, then

$$\int_s^\infty F(u) du = \mathcal{L}\left\{\frac{f(t)}{t}\right\}.$$

(Hint: Use the defining integral to write

$$\int_s^\infty F(u) du = \int_s^\infty \left( \int_0^\infty f(t) e^{-ut} dt \right) du$$

and then reverse the order of integration.)

b) Start with the result obtained in Problem 12.21(c) for  $\mathcal{L}\{t \sin \beta t\}$  and use the operational transform given in (a) of this problem to find  $\mathcal{L}\{\sin \beta t\}$ .

### Section 12.6

**12.26** In the circuit shown in Fig. 12.16, the dc current source is replaced with a sinusoidal source that delivers a current of  $5 \cos 20t$  A. The circuit components are  $R = 1.25 \Omega$ ,  $C = 50$  mF, and  $L = 200$  mH. Find the numerical expression for  $V(s)$ .

**12.27** There is no energy stored in the circuit shown in Fig. P12.27 at the time the switch is opened.

a) Derive the integrodifferential equation that governs the behavior of the voltage  $v_o$ .

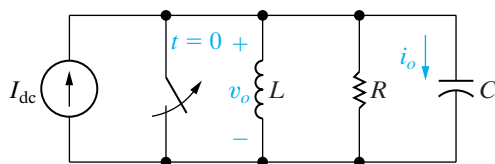
b) Show that

$$V_o(s) = \frac{I_{dc}/C}{s^2 + (1/RC)s + (1/LC)}.$$

c) Show that

$$I_o(s) = \frac{sI_{dc}}{s^2 + (1/RC)s + (1/LC)}.$$

Figure P12.27



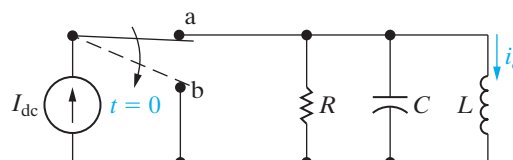
**12.28** The switch in the circuit in Fig. P12.28 has been in position a for a long time. At  $t = 0$ , the switch moves instantaneously to position b.

a) Derive the integrodifferential equation that governs the behavior of the current  $i_o$  for  $t \geq 0^+$ .

b) Show that

$$I_o(s) = \frac{I_{dc}[s + (1/RC)]}{[s^2 + (1/RC)s + (1/LC)]}.$$

Figure P12.28



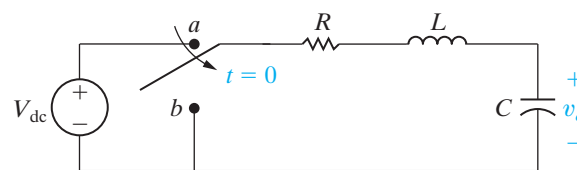
**12.29** The switch in the circuit in Fig. P12.29 has been in position a for a long time. At  $t = 0$ , the switch moves instantaneously to position b.

a) Derive the integrodifferential equation that governs the behavior of the voltage  $v_o$  for  $t \geq 0^+$ .

b) Show that

$$V_o(s) = \frac{V_{dc}[s + (R/L)]}{[s^2 + (R/L)s + (1/LC)]}.$$

Figure P12.29



**12.30** The switch in the circuit in Fig. P12.30 has been open for a long time. At  $t = 0$ , the switch closes.

a) Derive the integrodifferential equation that governs the behavior of the voltage  $v_o$  for  $t \geq 0$ .

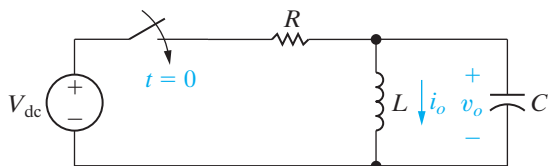
b) Show that

$$V_o(s) = \frac{V_{dc}/RC}{s^2 + (1/RC)s + (1/LC)}.$$

c) Show that

$$I_o(s) = \frac{V_{dc}/RLC}{s[s^2 + (1/RC)s + (1/LC)]}.$$

Figure P12.30

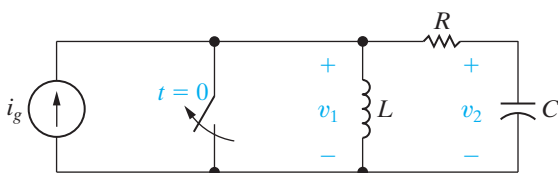


12.31 There is no energy stored in the circuit shown in Fig. P12.31 at the time the switch is opened.

- Derive the integrodifferential equations that govern the behavior of the node voltages  $v_1$  and  $v_2$ .
- Show that

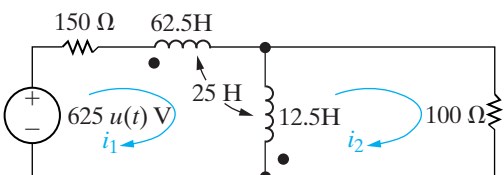
$$V_2(s) = \frac{sI_g(s)}{C[s^2 + (R/L)s + (1/LC)]}$$

Figure P12.31



- 12.32 a) Write the two simultaneous differential equations that describe the circuit shown in Fig. P12.32 in terms of the mesh currents  $i_1$  and  $i_2$ .
- b) Laplace-transform the equations derived in (a). Assume that the initial energy stored in the circuit is zero.
- c) Solve the equations in (b) for  $I_1(s)$  and  $I_2(s)$ .

Figure P12.32



Section 12.7

12.33 Find  $v(t)$  in Problem 12.26.

12.34 The circuit parameters in the circuit seen in Fig. P12.27 have the following values:  $R = 20 \Omega$ ,  $L = 50 \text{ mH}$ ,  $C = 20 \mu\text{F}$ , and  $I_{dc} = 75 \text{ mA}$ .

- Find  $v_o(t)$  for  $t \geq 0$ .
- Find  $i_o(t)$  for  $t \geq 0$ .
- Does your solution for  $i_o(t)$  make sense when  $t = 0$ ? Explain.

12.35 The circuit parameters in the circuit in Fig. P12.28 are  $R = 2.5 \text{ k}\Omega$ ,  $L = 50 \text{ mH}$ , and  $C = 2 \text{ nF}$ . If  $I_{dc} = 40 \text{ mA}$ , find  $i_o(t)$  for  $t \geq 0$ .

12.36 The circuit parameters in the circuit in Fig. P12.29 are  $R = 4 \text{ k}\Omega$ ,  $L = 400 \text{ mH}$ , and  $C = 156.25 \text{ nF}$ . If  $V_{dc} = 120 \text{ V}$ , find  $v_o(t)$  for  $t \geq 0$ .

12.37 The circuit parameters in the circuit in Fig. P12.30 are  $R = 2 \text{ k}\Omega$ ;  $L = 1.6 \text{ H}$ ; and  $C = 5 \mu\text{F}$ . If  $V_{dc}$  is  $56 \text{ V}$ , find

- $v_o(t)$  for  $t \geq 0$
- $i_o(t)$  for  $t \geq 0$

12.38 The circuit parameters in the circuit in Fig. P12.31 are  $R = 4000 \Omega$ ;  $L = 40 \text{ mH}$ ; and  $C = 15.625 \text{ nF}$ . If  $i_g(t) = 150 \text{ mA}$ , find  $v_2(t)$ .

12.39 Use the results from Problem 12.32 and the circuit shown in Fig P12.32 to

- Find  $i_1(t)$  and  $i_2(t)$ .
- Find  $i_1(\infty)$  and  $i_2(\infty)$ .
- Do the solutions for  $i_1$  and  $i_2$  make sense? Explain.

12.40 Find  $f(t)$  for each of the following functions:

- $F(s) = \frac{6(s + 10)}{(s + 5)(s + 8)}$ .
- $F(s) = \frac{20s^2 + 141s + 315}{s(s^2 + 10s + 21)}$ .
- $F(s) = \frac{15s^2 + 112s + 228}{(s + 2)(s + 4)(s + 6)}$ .
- $F(s) = \frac{2s^3 + 33s^2 + 93s + 54}{s(s + 1)(s^2 + 5s + 6)}$ .

12.41 Find  $f(t)$  for each of the following functions.

- $F(s) = \frac{280}{s^2 + 14s + 245}$ .
- $F(s) = \frac{-s^2 + 52s + 445}{s(s^2 + 10s + 89)}$ .
- $F(s) = \frac{14s^2 + 56s + 152}{(s + 6)(s^2 + 4s + 20)}$ .
- $F(s) = \frac{8(s + 1)^2}{(s^2 + 10s + 34)(s^2 + 8s + 20)}$ .

**12.42** Find  $f(t)$  for each of the following functions.

a)  $F(s) = \frac{320}{s^2(s+8)}$ .

b)  $F(s) = \frac{80(s+3)}{s(s+2)^2}$ .

c)  $F(s) = \frac{60(s+5)}{(s+1)^2(s^2+6s+25)}$ .

d)  $F(s) = \frac{25(s+4)^2}{s^2(s+5)^2}$ .

**12.43** Find  $f(t)$  for each of the following functions.

a)  $F(s) = \frac{135}{s(s+3)^3}$ .

b)  $F(s) = \frac{10(s+2)^2}{(s^2+2s+2)^2}$ .

c)  $F(s) = \frac{25s^2 + 395s + 1494}{s^2 + 15s + 54}$ .

d)  $F(s) = \frac{5s^3 + 20s^2 - 49s - 108}{s^2 + 7s + 10}$ .

**12.44** Derive the transform pair given by Eq. 12.64.

**12.45** a) Derive the transform pair given by Eq. 12.83.

b) Derive the transform pair given by Eq. 12.84.

### Sections 12.8–12.9

**12.46** a) Use the initial-value theorem to find the initial value of  $v$  in Problem 12.26.

b) Can the final-value theorem be used to find the steady-state value of  $v$ ? Why?

**12.47** Use the initial- and final-value theorems to check the initial and final values of the current and voltage in Problem 12.27.

**12.48** Use the initial- and final-value theorems to check the initial and final values of the current in Problem 12.28.

**12.49** Use the initial- and final-value theorems to check the initial and final values of the current and voltage in Problem 12.30.

**12.50** Apply the initial- and final-value theorems to each transform pair in Problem 12.40.

**12.51** Apply the initial- and final-value theorems to each transform pair in Problem 12.41.

**12.52** Apply the initial- and final-value theorems to each transform pair in Problem 12.42.

**12.53** Apply the initial- and final-value theorems to each transform pair in Problem 12.43.

### Sections 12.1–12.9

**12.54** a) Use phasor circuit analysis techniques from Chapter 9 to determine the steady-state expression for the inductor current in Fig. 12.18.

b) How does your result in part (a) compare to the complete response as given in Eq. 12.109?

**12.55** Find the maximum magnitude of the sinusoidal source in Fig. 12.18 such that the complete response of the inductor current does not exceed the 40 mA current rating at  $t = 1$  ms.

**12.56** Suppose the input to the circuit in Fig. 12.18 is a damped ramp of the form  $Kte^{-100t}$  V. Find the largest value of  $K$  such that the inductor current does not exceed the 40 mA current rating.



# CHAPTER 13

## CHAPTER CONTENTS

- 13.1 **Circuit Elements in the  $s$  Domain** *p. 466*
- 13.2 **Circuit Analysis in the  $s$  Domain** *p. 468*
- 13.3 **Applications** *p. 470*
- 13.4 **The Transfer Function** *p. 482*
- 13.5 **The Transfer Function in Partial Fraction Expansions** *p. 484*
- 13.6 **The Transfer Function and the Convolution Integral** *p. 487*
- 13.7 **The Transfer Function and the Steady-State Sinusoidal Response** *p. 493*
- 13.8 **The Impulse Function in Circuit Analysis** *p. 496*

## ✓ CHAPTER OBJECTIVES

- 1 Be able to transform a circuit into the  $s$  domain using Laplace transforms; be sure you understand how to represent the initial conditions on energy-storage elements in the  $s$  domain.
- 2 Know how to analyze a circuit in the  $s$ -domain and be able to transform an  $s$ -domain solution back to the time domain.
- 3 Understand the definition and significance of the transfer function and be able to calculate the transfer function for a circuit using  $s$ -domain techniques.
- 4 Know how to use a circuit's transfer function to calculate the circuit's unit impulse response, its unit step response, and its steady-state response to a sinusoidal input.

# The Laplace Transform in Circuit Analysis

**The Laplace transform** has two characteristics that make it an attractive tool in circuit analysis. First, it transforms a set of linear constant-coefficient differential equations into a set of linear polynomial equations, which are easier to manipulate. Second, it automatically introduces into the polynomial equations the initial values of the current and voltage variables. Thus, initial conditions are an inherent part of the transform process. (This contrasts with the classical approach to the solution of differential equations, in which initial conditions are considered when the unknown coefficients are evaluated.)

We begin this chapter by showing how we can skip the step of writing time-domain integrodifferential equations and transforming them into the  $s$  domain. In Section 13.1, we'll develop the  $s$ -domain circuit models for resistors, inductors, and capacitors so that we can write  $s$ -domain equations for all circuits directly. Section 13.2 reviews Ohm's and Kirchhoff's laws in the context of the  $s$  domain. After establishing these fundamentals, we apply the Laplace transform method to a variety of circuit problems in Section 13.3.

Analytical and simplification techniques first introduced with resistive circuits—such as mesh-current and node-voltage methods and source transformations—can be used in the  $s$  domain as well. After solving for the circuit response in the  $s$  domain, we inverse transform back to the time domain, using partial fraction expansion (as demonstrated in the preceding chapter). As before, checking the final time-domain equations in terms of the initial conditions and final values is an important step in the solution process.

The  $s$ -domain descriptions of circuit input and output lead us, in Section 13.4, to the concept of the transfer function. The transfer function for a particular circuit is the ratio of the Laplace transform of its output to the Laplace transform of its input. In Chapters 14 and 15, we'll examine the design uses of the transfer function, but here we focus on its use as an analytical tool. We continue this chapter with a look at the role of partial fraction

## Practical Perspective

### Surge Suppressors

With the advent of home-based personal computers, modems, fax machines, and other sensitive electronic equipment, it is necessary to provide protection from voltage surges that can occur in a household circuit due to switching. A commercially available surge suppressor is shown in the accompanying figure.

How can flipping a switch to turn on a light or turn off a hair dryer cause a voltage surge? At the end of this chapter, we will answer that question using Laplace transform techniques to analyze a circuit. We will illustrate how a voltage surge can be created by switching off a resistive load in a circuit operating in the sinusoidal steady state.



Stockbyte / Getty Images, Inc.

expansion (Section 13.5) and the convolution integral (Section 13.6) in employing the transfer function in circuit analysis. We conclude with a look at the impulse function in circuit analysis.

### 13.1 Circuit Elements in the $s$ Domain

The procedure for developing an  $s$ -domain equivalent circuit for each circuit element is simple. First, we write the time-domain equation that relates the terminal voltage to the terminal current. Next, we take the Laplace transform of the time-domain equation. This step generates an algebraic relationship between the  $s$ -domain current and voltage. Note that the dimension of a transformed voltage is volt-seconds, and the dimension of a transformed current is ampere-seconds. A voltage-to-current ratio in the  $s$  domain carries the dimension of volts per ampere. An impedance in the  $s$  domain is measured in ohms, and an admittance is measured in siemens. Finally, we construct a circuit model that satisfies the relationship between the  $s$ -domain current and voltage. We use the passive sign convention in all the derivations.

#### A Resistor in the $s$ Domain

We begin with the resistance element. From Ohm’s law,

$$v = Ri. \tag{13.1}$$

Because  $R$  is a constant, the Laplace transform of Eq. 13.1 is

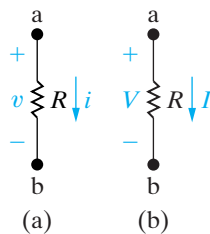
$$V = RI, \tag{13.2}$$

where

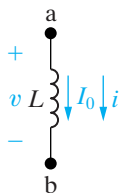
$$V = \mathcal{L}\{v\} \quad \text{and} \quad I = \mathcal{L}\{i\}.$$

Equation 13.2 states that the  $s$ -domain equivalent circuit of a resistor is simply a resistance of  $R$  ohms that carries a current of  $I$  ampere-seconds and has a terminal voltage of  $V$  volt-seconds.

Figure 13.1 shows the time- and frequency-domain circuits of the resistor. Note that going from the time domain to the frequency domain does not change the resistance element.



**Figure 13.1** ▲ The resistance element. (a) Time domain. (b) Frequency domain.



**Figure 13.2** ▲ An inductor of  $L$  henrys carrying an initial current of  $I_0$  amperes.

#### An Inductor in the $s$ Domain

Figure 13.2 shows an inductor carrying an initial current of  $I_0$  amperes. The time-domain equation that relates the terminal voltage to the terminal current is

$$v = L \frac{di}{dt}. \tag{13.3}$$

The Laplace transform of Eq. 13.3 gives

$$V = L[sI - i(0^-)] = sLI - LI_0. \tag{13.4}$$

Two different circuit configurations satisfy Eq. 13.4. The first consists of an impedance of  $sL$  ohms in series with an independent voltage source of  $LI_0$  volt-seconds, as shown in Fig. 13.3. Note that the polarity marks on the voltage source  $LI_0$  agree with the minus sign in Eq. 13.4. Note also that  $LI_0$  carries its own algebraic sign; that is, if the initial value of  $i$  is opposite to the reference direction for  $i$ , then  $I_0$  has a negative value.

The second  $s$ -domain equivalent circuit that satisfies Eq. 13.4 consists of an impedance of  $sL$  ohms in parallel with an independent current source of  $I_0/s$  ampere-seconds, as shown in Fig. 13.4. We can derive the alternative equivalent circuit shown in Fig. 13.4 in several ways. One way is simply to solve Eq. 13.4 for the current  $I$  and then construct the circuit to satisfy the resulting equation. Thus

$$I = \frac{V + LI_0}{sL} = \frac{V}{sL} + \frac{I_0}{s}. \quad (13.5)$$

Two other ways are: (1) find the Norton equivalent of the circuit shown in Fig. 13.3 and (2) start with the inductor current as a function of the inductor voltage and then find the Laplace transform of the resulting integral equation. We leave these two approaches to Problems 13.1 and 13.2.

If the initial energy stored in the inductor is zero, that is, if  $I_0 = 0$ , the  $s$ -domain equivalent circuit of the inductor reduces to an inductor with an impedance of  $sL$  ohms. Figure 13.5 shows this circuit.

## A Capacitor in the $s$ Domain

An initially charged capacitor also has two  $s$ -domain equivalent circuits. Figure 13.6 shows a capacitor initially charged to  $V_0$  volts. The terminal current is

$$i = C \frac{dv}{dt}. \quad (13.6)$$

Transforming Eq. 13.6 yields

$$I = C[sV - v(0^-)]$$

or

$$I = sCV - CV_0, \quad (13.7)$$

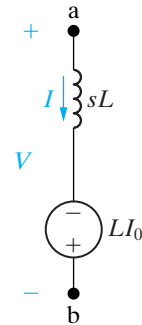
which indicates that the  $s$ -domain current  $I$  is the sum of two branch currents. One branch consists of an admittance of  $sC$  siemens, and the second branch consists of an independent current source of  $CV_0$  ampere-seconds. Figure 13.7 shows this parallel equivalent circuit.

We derive the series equivalent circuit for the charged capacitor by solving Eq. 13.7 for  $V$ :

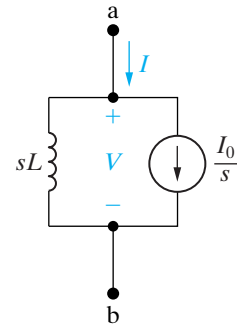
$$V = \left( \frac{1}{sC} \right) I + \frac{V_0}{s}. \quad (13.8)$$

Figure 13.8 shows the circuit that satisfies Eq. 13.8.

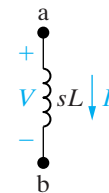
In the equivalent circuits shown in Figs. 13.7 and 13.8,  $V_0$  carries its own algebraic sign. In other words, if the polarity of  $V_0$  is opposite to the reference polarity for  $v$ ,  $V_0$  is a negative quantity. If the initial voltage on



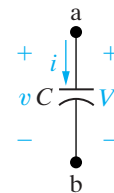
**Figure 13.3** ▲ The series equivalent circuit for an inductor of  $L$  henrys carrying an initial current of  $I_0$  amperes.



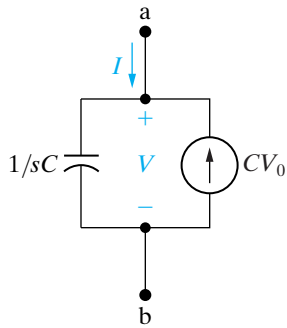
**Figure 13.4** ▲ The parallel equivalent circuit for an inductor of  $L$  henrys carrying an initial current of  $I_0$  amperes.



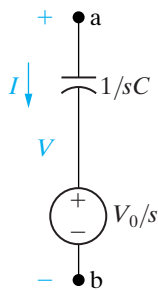
**Figure 13.5** ▲ The  $s$ -domain circuit for an inductor when the initial current is zero.



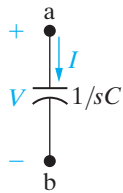
**Figure 13.6** ▲ A capacitor of  $C$  farads initially charged to  $V_0$  volts.



**Figure 13.7** ▲ The parallel equivalent circuit for a capacitor initially charged to  $V_0$  volts.



**Figure 13.8** ▲ The series equivalent circuit for a capacitor initially charged to  $V_0$  volts.



**Figure 13.9** ▲ The  $s$ -domain circuit for a capacitor when the initial voltage is zero.

the capacitor is zero, both equivalent circuits reduce to an impedance of  $1/sC$  ohms, as shown in Fig. 13.9.

In this chapter, an important first problem-solving step will be to choose between the parallel or series equivalents when inductors and capacitors are present. With a little forethought and some experience, the correct choice will often be quite evident. The equivalent circuits are summarized in Table 13.1.

TABLE 13.1 Summary of the $s$ -Domain Equivalent Circuits	
TIME DOMAIN	FREQUENCY DOMAIN
<p><math>v = Ri</math></p>	<p><math>V = RI</math></p>
<p><math>v = L di/dt,</math> <math>i = \frac{1}{L} \int_0^t v dx + I_0</math></p>	<p><math>V = sLI - LI_0</math></p> <p><math>I = \frac{V}{sL} + \frac{I_0}{s}</math></p>
<p><math>i = C dv/dt,</math> <math>v = \frac{1}{C} \int_0^t -i dx + V_0</math></p>	<p><math>V = \frac{I}{sC} + \frac{V_0}{s}</math></p> <p><math>I = sCV - CV_0</math></p>

## 13.2 Circuit Analysis in the $s$ Domain

Before illustrating how to use the  $s$ -domain equivalent circuits in analysis, we need to lay some groundwork.

First, we know that if no energy is stored in the inductor or capacitor, the relationship between the terminal voltage and current for each passive element takes the form:

Ohm's law in the  $s$ -domain ►

$$V = ZI, \tag{13.9}$$

where  $Z$  refers to the  $s$ -domain impedance of the element. Thus a resistor has an impedance of  $R$  ohms, an inductor has an impedance of  $sL$  ohms,

and a capacitor has an impedance of  $1/sC$  ohms. The relationship contained in Eq. 13.9 is also contained in Figs. 13.1(b), 13.5, and 13.9. Equation 13.9 is sometimes referred to as Ohm's law for the  $s$  domain.

The reciprocal of the impedance is admittance. Therefore, the  $s$  domain admittance of a resistor is  $1/R$  siemens, an inductor has an admittance of  $1/sL$  siemens, and a capacitor has an admittance of  $sC$  siemens.

The rules for combining impedances and admittances in the  $s$  domain are the same as those for frequency-domain circuits. Thus series-parallel simplifications and  $\Delta$ -to- $Y$  conversions also are applicable to  $s$ -domain analysis.

In addition, Kirchhoff's laws apply to  $s$ -domain currents and voltages. Their applicability stems from the operational transform stating that the Laplace transform of a sum of time-domain functions is the sum of the transforms of the individual functions (see Table 12.2). Because the algebraic sum of the currents at a node is zero in the time domain, the algebraic sum of the transformed currents is also zero. A similar statement holds for the algebraic sum of the transformed voltages around a closed path. The  $s$ -domain version of Kirchhoff's laws is

$$\text{alg } \sum I = 0, \quad (13.10)$$

$$\text{alg } \sum V = 0. \quad (13.11)$$

Because the voltage and current at the terminals of a passive element are related by an algebraic equation and because Kirchhoff's laws still hold, all the techniques of circuit analysis developed for pure resistive networks may be used in  $s$ -domain analysis. Thus node voltages, mesh currents, source transformations, and Thévenin-Norton equivalents are all valid techniques, even when energy is stored initially in the inductors and capacitors. Initially stored energy requires that we modify Eq. 13.9 by simply adding independent sources either in series or parallel with the element impedances. The addition of these sources is governed by Kirchhoff's laws.

## ✓ ASSESSMENT PROBLEMS

### Objective 1—Be able to transform a circuit into the $s$ domain using Laplace transforms

**13.1** A  $500 \Omega$  resistor, a 16 mH inductor, and a 25 nF capacitor are connected in parallel.

- Express the admittance of this parallel combination of elements as a rational function of  $s$ .
- Compute the numerical values of the zeros and poles.

**Answer:** (a)  $25 \times 10^{-9}(s^2 + 80,000s + 25 \times 10^8)/s$ ;  
 (b)  $-z_1 = -40,000 - j30,000$ ;  
 $-z_2 = -40,000 + j30,000$ ;  $p_1 = 0$ .

**13.2** The parallel circuit in Assessment Problem 13.1 is placed in series with a  $2000 \Omega$  resistor.

- Express the impedance of this series combination as a rational function of  $s$ .
- Compute the numerical values of the zeros and poles.

**Answer:** (a)  $2000(s + 50,000)^2/(s^2 + 80,000s + 25 \times 10^8)$ ;  
 (b)  $-z_1 = -z_2 = -50,000$ ;  
 $-p_1 = -40,000 - j30,000$ ;  
 $-p_2 = -40,000 + j30,000$ .

*NOTE:* Also try Chapter Problems 13.4 and 13.5.

## 13.3 Applications

We now illustrate how to use the Laplace transform to determine the transient behavior of several linear lumped-parameter circuits. We start by analyzing familiar circuits from Chapters 7 and 8 because they represent a simple starting place and because they show that the Laplace transform approach yields the same results. In all the examples, the ease of manipulating algebraic equations instead of differential equations should be apparent.

### The Natural Response of an $RC$ Circuit

We first revisit the natural response of an  $RC$  circuit (Fig. 13.10) via Laplace transform techniques. (You may want to review the classical analysis of this same circuit in Section 7.2).

The capacitor is initially charged to  $V_0$  volts, and we are interested in the time-domain expressions for  $i$  and  $v$ . We start by finding  $i$ . In transferring the circuit in Fig. 13.10 to the  $s$  domain, we have a choice of two equivalent circuits for the charged capacitor. Because we are interested in the current, the series-equivalent circuit is more attractive; it results in a single-mesh circuit in the frequency domain. Thus we construct the  $s$ -domain circuit shown in Fig. 13.11.

Summing the voltages around the mesh generates the expression

$$\frac{V_0}{s} = \frac{1}{sC}I + RI. \quad (13.12)$$

Solving Eq. 13.12 for  $I$  yields

$$I = \frac{CV_0}{RCs + 1} = \frac{V_0/R}{s + (1/RC)}. \quad (13.13)$$

Note that the expression for  $I$  is a proper rational function of  $s$  and can be inverse-transformed by inspection:

$$i = \frac{V_0}{R}e^{-t/RC}u(t), \quad (13.14)$$

which is equivalent to the expression for the current derived by the classical methods discussed in Chapter 7. In that chapter, the current is given by Eq. 7.26, where  $\tau$  is used in place of  $RC$ .

After we have found  $i$ , the easiest way to determine  $v$  is simply to apply Ohm's law; that is, from the circuit,

$$v = Ri = V_0e^{-t/RC}u(t). \quad (13.15)$$

We now illustrate a way to find  $v$  from the circuit without first finding  $i$ . In this alternative approach, we return to the original circuit of Fig. 13.10 and transfer it to the  $s$  domain using the parallel equivalent circuit for the charged capacitor. Using the parallel equivalent circuit is attractive now because we can describe the resulting circuit in terms of a single node voltage. Figure 13.12 shows the new  $s$ -domain equivalent circuit.

The node-voltage equation that describes the new circuit is

$$\frac{V}{R} + sCV = CV_0. \quad (13.16)$$

Solving Eq. 13.16 for  $V$  gives

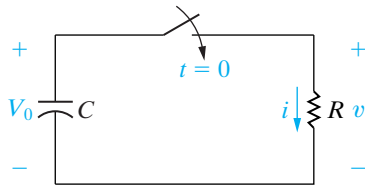


Figure 13.10 ▲ The capacitor discharge circuit.

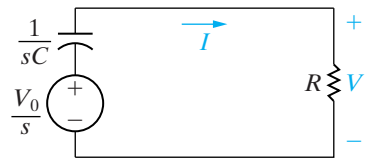


Figure 13.11 ▲ An  $s$ -domain equivalent circuit for the circuit shown in Fig. 13.10.

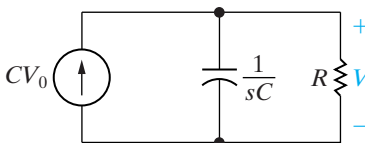


Figure 13.12 ▲ An  $s$ -domain equivalent circuit for the circuit shown in Fig. 13.10.



$$V = \frac{V_0}{s + (1/RC)}. \quad (13.17)$$

Inverse-transforming Eq. 13.17 leads to the same expression for  $v$  given by Eq. 13.15, namely,

$$v = V_0 e^{-t/RC} = V_0 e^{-t/\tau} u(t). \quad (13.18)$$

Our purpose in deriving by direct use of the transform method is to show that the choice of which  $s$ -domain equivalent circuit to use is influenced by which response signal is of interest.

### ASSESSMENT PROBLEM

**Objective 2—Know how to analyze a circuit in the  $s$  domain and be able to transform an  $s$  domain solution to the time domain**

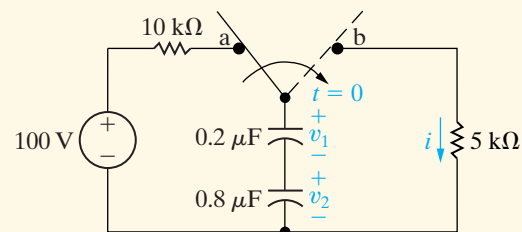
**13.3** The switch in the circuit shown has been in position a for a long time. At  $t = 0$ , the switch is thrown to position b.

- Find  $I$ ,  $V_1$ , and  $V_2$  as rational functions of  $s$ .
- Find the time-domain expressions for  $i$ ,  $v_1$ , and  $v_2$ .

**Answer:** (a)  $I = 0.02/(s + 1250)$ ,  
 $V_1 = 80/(s + 1250)$ ,  
 $V_2 = 20/(s + 1250)$ ;

*NOTE: Also try Chapter Problems 13.11 and 13.14.*

$$(b) \quad i = 20e^{-1250t} u(t) \text{ mA}, \\ v_1 = 80e^{-1250t} u(t) \text{ V}, \\ v_2 = 20e^{-1250t} u(t) \text{ V}.$$



### The Step Response of a Parallel Circuit

Next we analyze the parallel  $RLC$  circuit, shown in Fig. 13.13, that we first analyzed in Example 8.7. The problem is to find the expression for  $i_L$  after the constant current source is switched across the parallel elements. The initial energy stored in the circuit is zero.

As before, we begin by constructing the  $s$ -domain equivalent circuit shown in Fig. 13.14. Note how easily an independent source can be transformed from the time domain to the frequency domain. We transform the source to the  $s$  domain simply by determining the Laplace transform of its time-domain function. Here, opening the switch results in a step change in the current applied to the circuit. Therefore the  $s$ -domain current source is  $\mathcal{L}\{I_{dc}u(t)\}$ , or  $I_{dc}/s$ . To find  $I_L$ , we first solve for  $V$  and then use

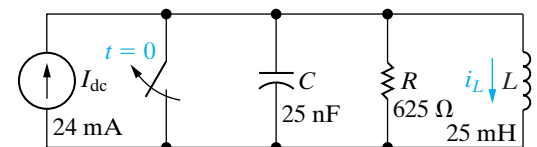
$$I_L = \frac{V}{sL} \quad (13.19)$$

to establish the  $s$ -domain expression for  $I_L$ . Summing the currents away from the top node generates the expression

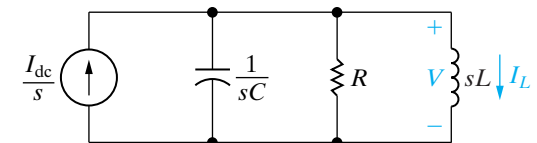
$$sCV + \frac{V}{R} + \frac{V}{sL} = \frac{I_{dc}}{s}. \quad (13.20)$$

Solving Eq. 13.20 for  $V$  gives

$$V = \frac{I_{dc}/C}{s^2 + (1/RC)s + (1/LC)}. \quad (13.21)$$



**Figure 13.13** ▲ The step response of a parallel  $RLC$  circuit.



**Figure 13.14** ▲ The  $s$ -domain equivalent circuit for the circuit shown in Fig. 13.13.

Substituting Eq. 13.21 into Eq. 13.19 gives

$$I_L = \frac{I_{dc}/LC}{s[s^2 + (1/RC)s + (1/LC)]}. \quad (13.22)$$

Substituting the numerical values of  $R$ ,  $L$ ,  $C$ , and  $I_{dc}$  into Eq. 13.22 yields

$$I_L = \frac{384 \times 10^5}{s(s^2 + 64,000s + 16 \times 10^8)}. \quad (13.23)$$

Before expanding Eq. 13.23 into a sum of partial fractions, we factor the quadratic term in the denominator:

$$I_L = \frac{384 \times 10^5}{s(s + 32,000 - j24,000)(s + 32,000 + j24,000)}. \quad (13.24)$$

Now, we can test the  $s$ -domain expression for  $I_L$  by checking to see whether the final-value theorem predicts the correct value for  $i_L$  at  $t = \infty$ . All the poles of  $I_L$ , except for the first-order pole at the origin, lie in the left half of the  $s$  plane, so the theorem is applicable. We know from the behavior of the circuit that after the switch has been open for a long time, the inductor will short-circuit the current source. Therefore, the final value of  $i_L$  must be 24 mA. The limit of  $sI_L$  as  $s \rightarrow 0$  is

$$\lim_{s \rightarrow 0} sI_L = \frac{384 \times 10^5}{16 \times 10^8} = 24 \text{ mA}. \quad (13.25)$$

(Currents in the  $s$  domain carry the dimension of ampere-seconds, so the dimension of  $sI_L$  will be amperes.) Thus our  $s$ -domain expression checks out.

We now proceed with the partial fraction expansion of Eq. 13.24:

$$\begin{aligned} I_L &= \frac{K_1}{s} + \frac{K_2}{s + 32,000 - j24,000} \\ &\quad + \frac{K_2^*}{s + 32,000 + j24,000}. \end{aligned} \quad (13.26)$$

The partial fraction coefficients are

$$K_1 = \frac{384 \times 10^5}{16 \times 10^8} = 24 \times 10^{-3}, \quad (13.27)$$

$$\begin{aligned} K_2 &= \frac{384 \times 10^5}{(-32,000 + j24,000)(j48,000)} \\ &= 20 \times 10^{-3} \angle 126.87^\circ. \end{aligned} \quad (13.28)$$

Substituting the numerical values of  $K_1$  and  $K_2$  into Eq. 13.26 and inverse-transforming the resulting expression yields

$$i_L = [24 + 40e^{-32,000t} \cos(24,000t + 126.87^\circ)]u(t) \text{ mA}. \quad (13.29)$$

The answer given by Eq. 13.29 is equivalent to the answer given for Example 8.7 because

$$40 \cos(24,000t + 126.87^\circ) = -24 \cos 24,000t - 32 \sin 24,000t.$$

If we weren't using a previous solution as a check, we would test Eq. 13.29 to make sure that  $i_L(0)$  satisfied the given initial conditions and  $i_L(\infty)$  satisfied the known behavior of the circuit.

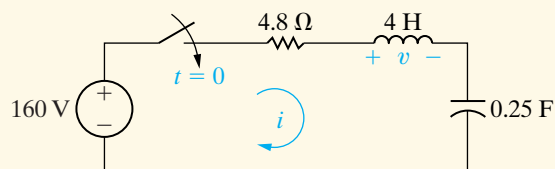
### ✓ ASSESSMENT PROBLEM

**Objective 2**—Know how to analyze a circuit in the  $s$  domain and be able to transform an  $s$  domain solution to the time domain

**13.4** The energy stored in the circuit shown is zero at the time when the switch is closed.

- Find the  $s$ -domain expression for  $I$ .
- Find the time-domain expression for  $i$  when  $t > 0$ .
- Find the  $s$ -domain expression for  $V$ .
- Find the time-domain expression for  $v$  when  $t > 0$ .

**Answer:** (a)  $I = 40/(s^2 + 1.2s + 1)$ ;  
 (b)  $i = (50e^{-0.6t} \sin 0.8t)u(t)$  A;  
 (c)  $V = 160s/(s^2 + 1.2s + 1)$ ;  
 (d)  $v = [200e^{-0.6t} \cos(0.8t + 36.87^\circ)]u(t)$  V.



*NOTE:* Also try Chapter Problems 13.13 and 13.25.

### The Transient Response of a Parallel $RLC$ Circuit

Another example of using the Laplace transform to find the transient behavior of a circuit arises from replacing the dc current source in the circuit shown in Fig. 13.13 with a sinusoidal current source. The new current source is

$$i_g = I_m \cos \omega t \text{ A}, \quad (13.30)$$

where  $I_m = 24$  mA and  $\omega = 40,000$  rad/s. As before, we assume that the initial energy stored in the circuit is zero.

The  $s$ -domain expression for the source current is

$$I_g = \frac{sI_m}{s^2 + \omega^2}. \quad (13.31)$$

The voltage across the parallel elements is

$$V = \frac{(I_g/C)s}{s^2 + (1/RC)s + (1/LC)}. \quad (13.32)$$

Substituting Eq. 13.31 into Eq. 13.32 results in

$$V = \frac{(I_m/C)s^2}{(s^2 + \omega^2)[s^2 + (1/RC)s + (1/LC)]}, \quad (13.33)$$

from which

$$I_L = \frac{V}{sL} = \frac{(I_m/LC)s}{(s^2 + \omega^2)[s^2 + (1/RC)s + (1/LC)]}. \quad (13.34)$$

Substituting the numerical values of  $I_m$ ,  $\omega$ ,  $R$ ,  $L$ , and  $C$  into Eq. 13.34 gives

$$I_L = \frac{384 \times 10^5 s}{(s^2 + 16 \times 10^8)(s^2 + 64,000s + 16 \times 10^8)}. \quad (13.35)$$

We now write the denominator in factored form:

$$I_L = \frac{384 \times 10^5 s}{(s - j\omega)(s + j\omega)(s + \alpha - j\beta)(s + \alpha + j\beta)}, \quad (13.36)$$

where  $\omega = 40,000$ ,  $\alpha = 32,000$ , and  $\beta = 24,000$ .

We can't test the final value of  $i_L$  with the final-value theorem because  $I_L$  has a pair of poles on the imaginary axis; that is, poles at  $\pm j4 \times 10^4$ . Thus we must first find  $i_L$  and then check the validity of the expression from known circuit behavior.

When we expand Eq. 13.36 into a sum of partial fractions, we generate the equation

$$I_L = \frac{K_1}{s - j40,000} + \frac{K_1^*}{s + j40,000} + \frac{K_2}{s + 32,000 - j24,000} + \frac{K_2^*}{s + 32,000 + j24,000}. \quad (13.37)$$

The numerical values of the coefficients  $K_1$  and  $K_2$  are

$$K_1 = \frac{384 \times 10^5(j40,000)}{(j80,000)(32,000 + j16,000)(32,000 + j64,000)} = 7.5 \times 10^{-3} \angle -90^\circ, \quad (13.38)$$

$$K_2 = \frac{384 \times 10^5(-32,000 + j24,000)}{(-32,000 - j16,000)(-32,000 + j64,000)(j48,000)} = 12.5 \times 10^{-3} \angle 90^\circ. \quad (13.39)$$

Substituting the numerical values from Eqs. 13.38 and 13.39 into Eq. 13.37 and inverse-transforming the resulting expression yields

$$i_L = [15 \cos(40,000t - 90^\circ) + 25e^{-32,000t} \cos(24,000t + 90^\circ)] \text{ mA}, \\ = (15 \sin 40,000t - 25e^{-32,000t} \sin 24,000t)u(t) \text{ mA}. \quad (13.40)$$

We now test Eq. 13.40 to see whether it makes sense in terms of the given initial conditions and the known circuit behavior after the switch has been open for a long time. For  $t = 0$ , Eq. 13.40 predicts zero initial current, which agrees with the initial energy of zero in the circuit. Equation 13.40 also predicts a steady-state current of

$$i_{L_{ss}} = 15 \sin 40,000t \text{ mA}, \quad (13.41)$$

which can be verified by the phasor method (Chapter 9).

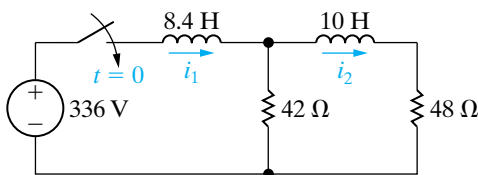


Figure 13.15 ▲ A multiple-mesh  $RL$  circuit.

## The Step Response of a Multiple Mesh Circuit

Until now, we avoided circuits that required two or more node-voltage or mesh-current equations, because the techniques for solving simultaneous differential equations are beyond the scope of this text. However, using Laplace techniques, we can solve a problem like the one posed by the multiple-mesh circuit in Fig. 13.15.

Here we want to find the branch currents  $i_1$  and  $i_2$  that arise when the 336 V dc voltage source is applied suddenly to the circuit. The initial energy stored in the circuit is zero. Figure 13.16 shows the  $s$ -domain equivalent circuit of Fig. 13.15. The two mesh-current equations are

$$\frac{336}{s} = (42 + 8.4s)I_1 - 42I_2, \quad (13.42)$$

$$0 = -42I_1 + (90 + 10s)I_2. \quad (13.43)$$

Using Cramer's method to solve for  $I_1$  and  $I_2$ , we obtain

$$\begin{aligned} \Delta &= \begin{vmatrix} 42 + 8.4s & -42 \\ -42 & 90 + 10s \end{vmatrix} \\ &= 84(s^2 + 14s + 24) \\ &= 84(s + 2)(s + 12), \end{aligned} \quad (13.44)$$

$$\begin{aligned} N_1 &= \begin{vmatrix} 336/s & -42 \\ 0 & 90 + 10s \end{vmatrix} \\ &= \frac{3360(s + 9)}{s}, \end{aligned} \quad (13.45)$$

$$\begin{aligned} N_2 &= \begin{vmatrix} 42 + 8.4s & 336/s \\ -42 & 0 \end{vmatrix} \\ &= \frac{14,112}{s}. \end{aligned} \quad (13.46)$$

Based on Eqs. 13.44–13.46,

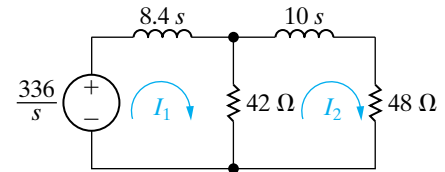
$$I_1 = \frac{N_1}{\Delta} = \frac{40(s + 9)}{s(s + 2)(s + 12)}, \quad (13.47)$$

$$I_2 = \frac{N_2}{\Delta} = \frac{168}{s(s + 2)(s + 12)}. \quad (13.48)$$

Expanding  $I_1$  and  $I_2$  into a sum of partial fractions gives

$$I_1 = \frac{15}{s} - \frac{14}{s + 2} - \frac{1}{s + 12}, \quad (13.49)$$

$$I_2 = \frac{7}{s} - \frac{8.4}{s + 2} + \frac{1.4}{s + 12}. \quad (13.50)$$



**Figure 13.16** ▲ The  $s$ -domain equivalent circuit for the circuit shown in Fig. 13.15.

We obtain the expressions for  $i_1$  and  $i_2$  by inverse-transforming Eqs. 13.49 and 13.50, respectively:

$$i_1 = (15 - 14e^{-2t} - e^{-12t})u(t) \text{ A}, \quad (13.51)$$

$$i_2 = (7 - 8.4e^{-2t} + 1.4e^{-12t})u(t) \text{ A}. \quad (13.52)$$

Next we test the solutions to see whether they make sense in terms of the circuit. Because no energy is stored in the circuit at the instant the switch is closed, both  $i_1(0^-)$  and  $i_2(0^-)$  must be zero. The solutions agree with these initial values. After the switch has been closed for a long time, the two inductors appear as short circuits. Therefore, the final values of  $i_1$  and  $i_2$  are

$$i_1(\infty) = \frac{336(90)}{42(48)} = 15 \text{ A}, \quad (13.53)$$

$$i_2(\infty) = \frac{15(42)}{90} = 7 \text{ A}. \quad (13.54)$$

One final test involves the numerical values of the exponents and calculating the voltage drop across the  $42 \Omega$  resistor by three different methods. From the circuit, the voltage across the  $42 \Omega$  resistor (positive at the top) is

$$v = 42(i_1 - i_2) = 336 - 8.4 \frac{di_1}{dt} = 48i_2 + 10 \frac{di_2}{dt}. \quad (13.55)$$

You should verify that regardless of which form of Eq. 13.55 is used, the voltage is

$$v = (336 - 235.2e^{-2t} - 100.80e^{-12t})u(t) \text{ V}.$$

We are thus confident that the solutions for  $i_1$  and  $i_2$  are correct.

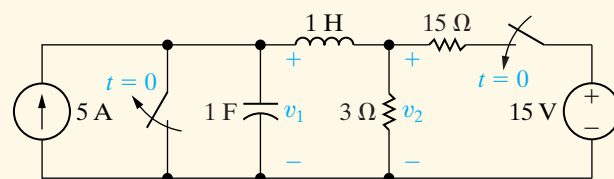
### ASSESSMENT PROBLEM

**Objective 2**—Know how to analyze a circuit in the  $s$  domain and be able to transform an  $s$  domain solution to the time domain

**13.5** The dc current and voltage sources are applied simultaneously to the circuit shown. No energy is stored in the circuit at the instant of application.

- Derive the  $s$ -domain expressions for  $V_1$  and  $V_2$ .
- For  $t > 0$ , derive the time-domain expressions for  $v_1$  and  $v_2$ .
- Calculate  $v_1(0^+)$  and  $v_2(0^+)$ .
- Compute the steady-state values of  $v_1$  and  $v_2$ .

- Answer:** (a)  $V_1 = [5(s + 3)]/[s(s + 0.5)(s + 2)]$ ,  
 $V_2 = [2.5(s^2 + 6)]/[s(s + 0.5)(s + 2)]$ ;  
 (b)  $v_1 = (15 - \frac{50}{3}e^{-0.5t} + \frac{5}{3}e^{-2t})u(t) \text{ V}$ ,  
 $v_2 = (15 - \frac{125}{6}e^{-0.5t} + \frac{25}{3}e^{-2t})u(t) \text{ V}$ ;  
 (c)  $v_1(0^+) = 0$ ,  $v_2(0^+) = 2.5 \text{ V}$ ;  
 (d)  $v_1 = v_2 = 15 \text{ V}$ .



**NOTE:** Also try Chapter Problems 13.19 and 13.21.

## The Use of Thévenin's Equivalent

In this section we show how to use Thévenin's equivalent in the  $s$  domain. Figure 13.17 shows the circuit to be analyzed. The problem is to find the capacitor current that results from closing the switch. The energy stored in the circuit prior to closing is zero.

To find  $i_C$ , we first construct the  $s$ -domain equivalent circuit and then find the Thévenin equivalent of this circuit with respect to the terminals of the capacitor. Figure 13.18 shows the  $s$ -domain circuit.

The Thévenin voltage is the open-circuit voltage across terminals a, b. Under open-circuit conditions, there is no voltage across the  $60\ \Omega$  resistor. Hence

$$V_{Th} = \frac{(480/s)(0.002s)}{20 + 0.002s} = \frac{480}{s + 10^4}. \quad (13.56)$$

The Thévenin impedance seen from terminals a and b equals the  $60\ \Omega$  resistor in series with the parallel combination of the  $20\ \Omega$  resistor and the  $2\ \text{mH}$  inductor. Thus

$$Z_{Th} = 60 + \frac{0.002s(20)}{20 + 0.002s} = \frac{80(s + 7500)}{s + 10^4}. \quad (13.57)$$

Using the Thévenin equivalent, we reduce the circuit shown in Fig. 13.18 to the one shown in Fig. 13.19. It indicates that the capacitor current  $I_C$  equals the Thévenin voltage divided by the total series impedance. Thus,

$$I_C = \frac{480/(s + 10^4)}{[80(s + 7500)/(s + 10^4)] + [(2 \times 10^5)/s]}. \quad (13.58)$$

We simplify Eq. 13.58 to

$$I_C = \frac{6s}{s^2 + 10,000s + 25 \times 10^6} = \frac{6s}{(s + 5000)^2}. \quad (13.59)$$

A partial fraction expansion of Eq. 13.59 generates

$$I_C = \frac{-30,000}{(s + 5000)^2} + \frac{6}{s + 5000}, \quad (13.60)$$

the inverse transform of which is

$$i_C = (-30,000te^{-5000t} + 6e^{-5000t})u(t)\ \text{A}. \quad (13.61)$$

We now test Eq. 13.61 to see whether it makes sense in terms of known circuit behavior. From Eq. 13.61,

$$i_C(0) = 6\ \text{A}. \quad (13.62)$$

This result agrees with the initial current in the capacitor, as calculated from the circuit in Fig. 13.17. The initial inductor current is zero and the initial capacitor voltage is zero, so the initial capacitor current is  $480/80$ , or  $6\ \text{A}$ . The final value of the current is zero, which also agrees with Eq. 13.61. Note also from this equation that the current reverses sign when  $t$  exceeds  $6/30,000$ , or  $200\ \mu\text{s}$ . The fact that  $i_C$  reverses sign makes sense because, when the switch first closes, the capacitor begins to charge. Eventually this charge is reduced to zero because the inductor is a short circuit at  $t = \infty$ . The sign reversal of  $i_C$  reflects the charging and discharging of the capacitor.

Let's assume that the voltage drop across the capacitor  $v_C$  is also of interest. Once we know  $i_C$ , we find  $v_C$  by integration in the time domain; that is,

$$v_C = 2 \times 10^5 \int_0^t (6 - 30,000x)e^{-5000x} dx. \quad (13.63)$$

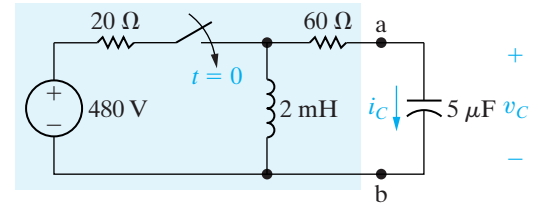


Figure 13.17 ▲ A circuit to be analyzed using Thévenin's equivalent in the  $s$  domain.

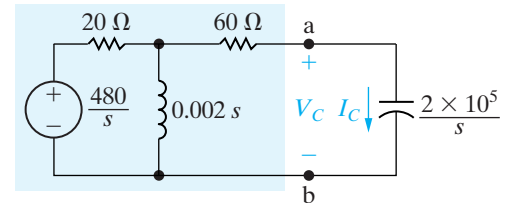


Figure 13.18 ▲ The  $s$ -domain model of the circuit shown in Fig. 13.17.

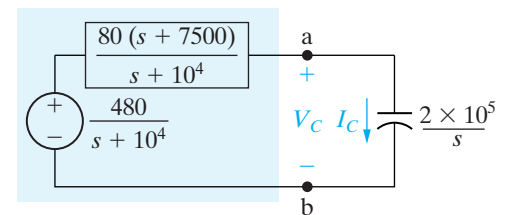


Figure 13.19 ▲ A simplified version of the circuit shown in Fig. 13.18, using a Thévenin equivalent.



Although the integration called for in Eq. 13.63 is not difficult, we may avoid it altogether by first finding the  $s$ -domain expression for  $V_c$  and then finding  $v_c$  by an inverse transform. Thus

$$V_C = \frac{1}{sC} I_C = \frac{2 \times 10^5}{s} \frac{6s}{(s + 5000)^2} = \frac{12 \times 10^5}{(s + 5000)^2}, \tag{13.64}$$

from which

$$v_C = 12 \times 10^5 t e^{-5000t} u(t). \tag{13.65}$$

You should verify that Eq. 13.65 is consistent with Eq. 13.63 and that it also supports the observations made with regard to the behavior of  $i_C$  (see Problem 13.33).

**ASSESSMENT PROBLEM**

**Objective 2**—Know how to analyze a circuit in the  $s$  domain and be able to transform an  $s$ -domain solution to the time domain

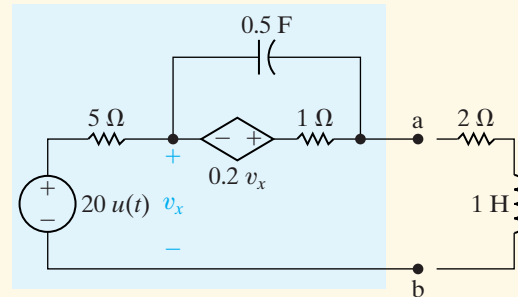
**13.6** The initial charge on the capacitor in the circuit shown is zero.

- a) Find the  $s$ -domain Thévenin equivalent circuit with respect to terminals a and b.
- b) Find the  $s$ -domain expression for the current that the circuit delivers to a load consisting of a 1 H inductor in series with a 2 Ω resistor.

**Answer:** (a)  $V_{Th} = V_{ab} = [20(s + 2.4)]/[s(s + 2)]$ ,  
 $Z_{Th} = 5(s + 2.8)/(s + 2)$ ;

*NOTE:* Also try Chapter Problem 13.35.

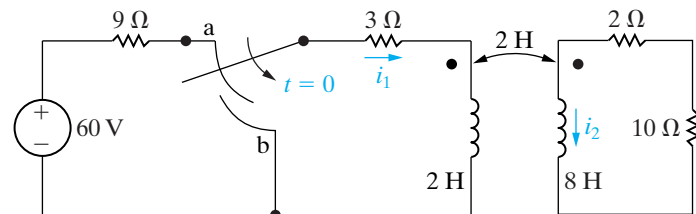
(b)  $I_{ab} = [20(s + 2.4)]/[s(s + 3)(s + 6)]$ .



**A Circuit with Mutual Inductance**

The next example illustrates how to use the Laplace transform to analyze the transient response of a circuit that contains mutual inductance. Figure 13.20 shows the circuit. The make-before-break switch has been in position a for a long time. At  $t = 0$ , the switch moves instantaneously to position b. The problem is to derive the time-domain expression for  $i_2$ .

We begin by redrawing the circuit in Fig. 13.20, with the switch in position b and the magnetically coupled coils replaced with a T-equivalent circuit.<sup>1</sup> Figure 13.21 shows the new circuit.



**Figure 13.20** ▲ A circuit containing magnetically coupled coils.

<sup>1</sup> See Appendix C.

We now transform this circuit to the  $s$  domain. In so doing, we note that

$$i_1(0^-) = \frac{60}{12} = 5 \text{ A}, \quad (13.66)$$

$$i_2(0^-) = 0. \quad (13.67)$$

Because we plan to use mesh analysis in the  $s$  domain, we use the series equivalent circuit for an inductor carrying an initial current. Figure 13.22 shows the  $s$ -domain circuit. Note that there is only one independent voltage source. This source appears in the vertical leg of the tee to account for the initial value of the current in the 2 H inductor of  $i_1(0^-) + i_2(0^-)$ , or 5 A. The branch carrying  $i_1$  has no voltage source because  $L_1 - M = 0$ .

The two  $s$ -domain mesh equations that describe the circuit in Fig. 13.22 are

$$(3 + 2s)I_1 + 2sI_2 = 10 \quad (13.68)$$

$$2sI_1 + (12 + 8s)I_2 = 10. \quad (13.69)$$

Solving for  $I_2$  yields

$$I_2 = \frac{2.5}{(s + 1)(s + 3)}. \quad (13.70)$$

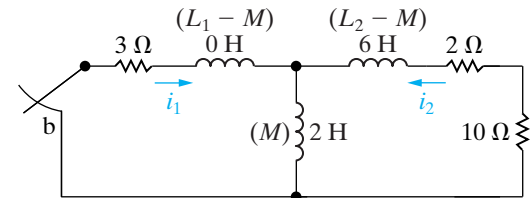
Expanding Eq. 13.70 into a sum of partial fractions generates

$$I_2 = \frac{1.25}{s + 1} - \frac{1.25}{s + 3}. \quad (13.71)$$

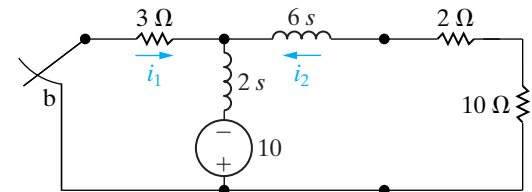
Then,

$$i_2 = (1.25e^{-t} - 1.25e^{-3t})u(t) \text{ A}. \quad (13.72)$$

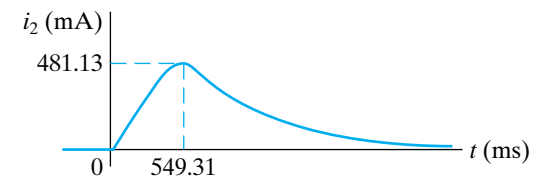
Equation 13.72 reveals that  $i_2$  increases from zero to a peak value of 481.13 mA in 549.31 ms after the switch is moved to position b. Thereafter,  $i_2$  decreases exponentially toward zero. Figure 13.23 shows a plot of  $i_2$  versus  $t$ . This response makes sense in terms of the known physical behavior of the magnetically coupled coils. A current can exist in the  $L_2$  inductor only if there is a time-varying current in the  $L_1$  inductor. As  $i_1$  decreases from its initial value of 5 A,  $i_2$  increases from zero and then approaches zero as  $i_1$  approaches zero.



**Figure 13.21** ▲ The circuit shown in Fig. 13.20, with the magnetically coupled coils replaced by a T-equivalent circuit.



**Figure 13.22** ▲ The  $s$ -domain equivalent circuit for the circuit shown in Fig. 13.21.



**Figure 13.23** ▲ The plot of  $i_2$  versus  $t$  for the circuit shown in Fig. 13.20.

## ASSESSMENT PROBLEM

**Objective 2**—Know how to analyze a circuit in the  $s$  domain and be able to transform an  $s$ -domain solution to the time domain

- 13.7** a) Verify from Eq. 13.72 that  $i_2$  reaches a peak value of 481.13 mA at  $t = 549.31$  ms.  
 b) Find  $i_1$ , for  $t > 0$ , for the circuit shown in Fig. 13.20.  
 c) Compute  $di_1/dt$  when  $i_2$  is at its peak value.  
 d) Express  $i_2$  as a function of  $di_1/dt$  when  $i_2$  is at its peak value.  
 e) Use the results obtained in (c) and (d) to calculate the peak value of  $i_2$ .

- Answer:** (a)  $di_2/dt = 0$  when  $t = \frac{1}{2} \ln 3$  (s);  
 (b)  $i_1 = 2.5(e^{-t} + e^{-3t})u(t)$  A;  
 (c)  $-2.89$  A/s;  
 (d)  $i_2 = -(Mdi_1/dt)/12$ ;  
 (e) 481.13 mA.

**NOTE:** Also try Chapter Problems 13.36 and 13.37.

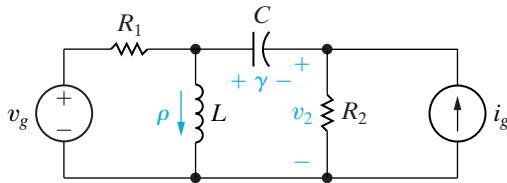


Figure 13.24 ▲ A circuit showing the use of superposition in  $s$ -domain analysis.

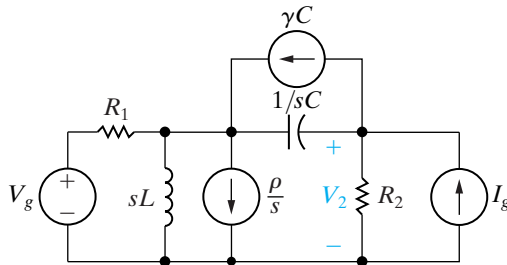


Figure 13.25 ▲ The  $s$ -domain equivalent for the circuit of Fig. 13.24.

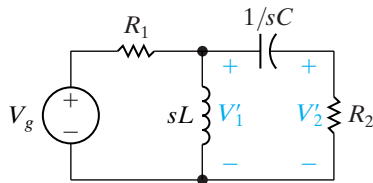


Figure 13.26 ▲ The circuit shown in Fig. 13.25 with  $V_g$  acting alone.

### The Use of Superposition

Because we are analyzing linear lumped-parameter circuits, we can use superposition to divide the response into components that can be identified with particular sources and initial conditions. Distinguishing these components is critical to being able to use the transfer function, which we introduce in the next section.

Figure 13.24 shows our illustrative circuit. We assume that at the instant when the two sources are applied to the circuit, the inductor is carrying an initial current of  $\rho$  amperes and that the capacitor is carrying an initial voltage of  $\gamma$  volts. The desired response of the circuit is the voltage across the resistor  $R_2$ , labeled  $v_2$ .

Figure 13.25 shows the  $s$ -domain equivalent circuit. We opted for the parallel equivalents for  $L$  and  $C$  because we anticipated solving for  $V_2$  using the node-voltage method.

To find  $V_2$  by superposition, we calculate the component of  $V_2$  resulting from each source acting alone, and then we sum the components. We begin with  $V_g$  acting alone. Opening each of the three current sources deactivates them. Figure 13.26 shows the resulting circuit. We added the node voltage  $V'_1$  to aid the analysis. The primes on  $V_1$  and  $V_2$  indicate that they are the components of  $V_1$  and  $V_2$  attributable to  $V_g$  acting alone. The two equations that describe the circuit in Fig. 13.26 are

$$\left(\frac{1}{R_1} + \frac{1}{sL} + sC\right)V'_1 - sCV'_2 = \frac{V_g}{R_1}, \tag{13.73}$$

$$-sCV'_1 + \left(\frac{1}{R_2} + sC\right)V'_2 = 0. \tag{13.74}$$

For convenience, we introduce the notation

$$Y_{11} = \frac{1}{R_1} + \frac{1}{sL} + sC; \tag{13.75}$$

$$Y_{12} = -sC; \tag{13.76}$$

$$Y_{22} = \frac{1}{R_2} + sC. \tag{13.77}$$

Substituting Eqs. 13.75–13.77 into Eqs. 13.73 and 13.74 gives

$$Y_{11}V'_1 + Y_{12}V'_2 = V_g/R_1, \tag{13.78}$$

$$Y_{12}V'_1 + Y_{22}V'_2 = 0. \tag{13.79}$$

Solving Eqs. 13.78 and 13.79 for  $V'_2$  gives

$$V'_2 = \frac{-Y_{12}/R_1}{Y_{11}Y_{22} - Y_{12}^2} V_g. \tag{13.80}$$

With the current source  $I_g$  acting alone, the circuit shown in Fig. 13.25 reduces to the one shown in Fig. 13.27. Here,  $V''_1$  and  $V''_2$  are the components of  $V_1$  and  $V_2$  resulting from  $I_g$ . If we use the notation introduced in

Eqs. 13.75–13.77, the two node-voltage equations that describe the circuit in Fig. 13.27 are

$$Y_{11}V_1'' + Y_{12}V_2'' = 0 \quad (13.81)$$

and

$$Y_{12}V_1'' + Y_{22}V_2'' = I_g. \quad (13.82)$$

Solving Eqs. 13.81 and 13.82 for  $V_2''$  yields

$$V_2'' = \frac{Y_{11}}{Y_{11}Y_{22} - Y_{12}^2} I_g. \quad (13.83)$$

To find the component of  $V_2$  resulting from the initial energy stored in the inductor ( $V_2'''$ ), we must solve the circuit shown in Fig. 13.28, where

$$Y_{11}V_1''' + Y_{12}V_2''' = -\rho/s, \quad (13.84)$$

$$Y_{12}V_1''' + Y_{22}V_2''' = 0. \quad (13.85)$$

Thus

$$V_2''' = \frac{Y_{12}/s}{Y_{11}Y_{22} - Y_{12}^2} \rho. \quad (13.86)$$

From the circuit shown in Fig. 13.29, we find the component of  $V_2$  ( $V_2''''$ ) resulting from the initial energy stored in the capacitor. The node-voltage equations describing this circuit are

$$Y_{11}V_1'''' + Y_{12}V_2'''' = \gamma C, \quad (13.87)$$

$$Y_{12}V_1'''' + Y_{22}V_2'''' = -\gamma C. \quad (13.88)$$

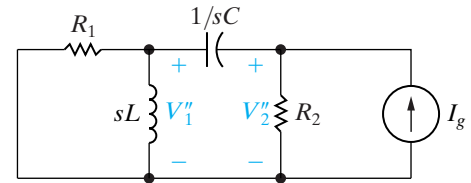
Solving for  $V_2''''$  yields

$$V_2'''' = \frac{-(Y_{11} + Y_{12})C}{Y_{11}Y_{22} - Y_{12}^2} \gamma. \quad (13.89)$$

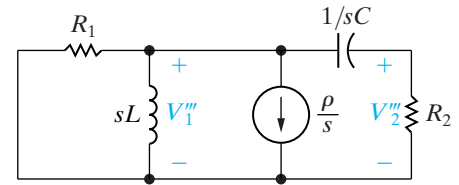
The expression for  $V_2$  is

$$\begin{aligned} V_2 &= V_2' + V_2'' + V_2''' + V_2'''' \\ &= \frac{-(Y_{12}/R_1)}{Y_{11}Y_{22} - Y_{12}^2} V_g + \frac{Y_{11}}{Y_{11}Y_{22} - Y_{12}^2} I_g \\ &\quad + \frac{Y_{12}/s}{Y_{11}Y_{22} - Y_{12}^2} \rho + \frac{-C(Y_{11} + Y_{12})}{Y_{11}Y_{22} - Y_{12}^2} \gamma. \end{aligned} \quad (13.90)$$

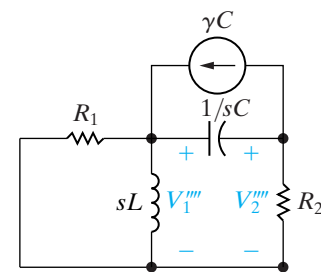
We can find  $V_2$  without using superposition by solving the two node-voltage equations that describe the circuit shown in Fig. 13.25. Thus



**Figure 13.27** ▲ The circuit shown in Fig. 13.25, with  $I_g$  acting alone.



**Figure 13.28** ▲ The circuit shown in Fig. 13.25, with the energized inductor acting alone.



**Figure 13.29** ▲ The circuit shown in Fig. 13.25, with the energized capacitor acting alone.

$$Y_{11}V_1 + Y_{12}V_2 = \frac{V_g}{R_1} + \gamma C - \frac{\rho}{s}, \tag{13.91}$$

$$Y_{12}V_1 + Y_{22}V_2 = I_g - \gamma C. \tag{13.92}$$

You should verify in Problem 13.42 that the solution of Eqs. 13.91 and 13.92 for  $V_2$  gives the same result as Eq. 13.90.

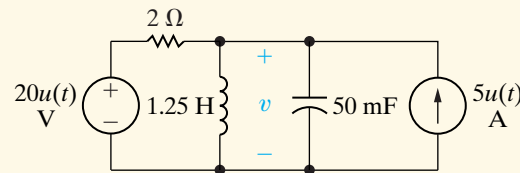
**ASSESSMENT PROBLEM**

**Objective 2**—Know how to analyze a circuit in the  $s$  domain and be able to transform an  $s$ -domain solution to the time domain

**13.8** The energy stored in the circuit shown is zero at the instant the two sources are turned on.

- a) Find the component of  $v$  for  $t > 0$  owing to the voltage source.
- b) Find the component of  $v$  for  $t > 0$  owing to the current source.
- c) Find the expression for  $v$  when  $t > 0$ .

**Answer:** (a)  $[(100/3)e^{-2t} - (100/3)e^{-8t}]u(t)$  V;  
 (b)  $[(50/3)e^{-2t} - (50/3)e^{-8t}]u(t)$  V;  
 (c)  $[50e^{-2t} - 50e^{-8t}]u(t)$  V.



*NOTE:* Also try Chapter Problem 13.43.

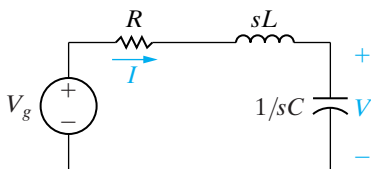
## 13.4 The Transfer Function

The **transfer function** is defined as the  $s$ -domain ratio of the Laplace transform of the output (response) to the Laplace transform of the input (source). In computing the transfer function, we restrict our attention to circuits where all initial conditions are zero. If a circuit has multiple independent sources, we can find the transfer function for each source and use superposition to find the response to all sources.

The transfer function is

$$H(s) = \frac{Y(s)}{X(s)}, \tag{13.93}$$

**Definition of a transfer function** ▶



**Figure 13.30** ▲ A series  $RLC$  circuit.

where  $Y(s)$  is the Laplace transform of the output signal, and  $X(s)$  is the Laplace transform of the input signal. Note that the transfer function depends on what is defined as the output signal. Consider, for example, the series circuit shown in Fig. 13.30. If the current is defined as the response signal of the circuit,

$$H(s) = \frac{I}{V_g} = \frac{1}{R + sL + 1/sC} = \frac{sC}{s^2LC + RCs + 1}. \tag{13.94}$$

In deriving Eq. 13.94, we recognized that  $I$  corresponds to the output  $Y(s)$  and  $V_g$  corresponds to the input  $X(s)$ .

If the voltage across the capacitor is defined as the output signal of the circuit shown in Fig. 13.30, the transfer function is

$$H(s) = \frac{V}{V_g} = \frac{1/sC}{R + sL + 1/sC} = \frac{1}{s^2LC + RCs + 1}. \quad (13.95)$$

Thus, because circuits may have multiple sources and because the definition of the output signal of interest can vary, a single circuit can generate many transfer functions. Remember that when multiple sources are involved, no single transfer function can represent the total output—transfer functions associated with each source must be combined using superposition to yield the total response. Example 13.1 illustrates the computation of a transfer function for known numerical values of  $R$ ,  $L$ , and  $C$ .

### Example 13.1 Deriving the Transfer Function of a Circuit

The voltage source  $v_g$  drives the circuit shown in Fig. 13.31. The response signal is the voltage across the capacitor,  $v_o$ .

- Calculate the numerical expression for the transfer function.
- Calculate the numerical values for the poles and zeros of the transfer function.

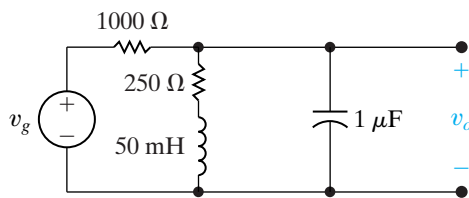


Figure 13.31 ▲ The circuit for Example 13.1.

### Solution

- The first step in finding the transfer function is to construct the  $s$ -domain equivalent circuit, as shown in Fig. 13.32. By definition, the transfer function is the ratio of  $V_o/V_g$ , which can be computed from a single node-voltage equation. Summing the currents away from the upper node generates

$$\frac{V_o - V_g}{1000} + \frac{V_o}{250 + 0.05s} = \frac{V_o s}{10^6} = 0.$$

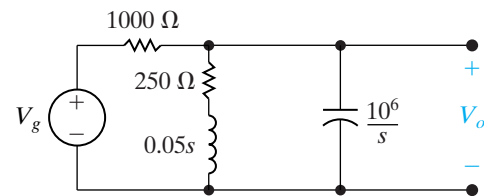


Figure 13.32 ▲ The  $s$ -domain equivalent circuit for the circuit shown in Fig. 13.31.

Solving for  $V_o$  yields

$$V_o = \frac{1000(s + 5000)V_g}{s^2 + 6000s + 25 \times 10^6}.$$

Hence the transfer function is

$$\begin{aligned} H(s) &= \frac{V_o}{V_g} \\ &= \frac{1000(s + 5000)}{s^2 + 6000s + 25 \times 10^6}. \end{aligned}$$

- The poles of  $H(s)$  are the roots of the denominator polynomial. Therefore

$$-p_1 = -3000 - j4000,$$

$$-p_2 = -3000 + j4000.$$

The zeros of  $H(s)$  are the roots of the numerator polynomial; thus  $H(s)$  has a zero at

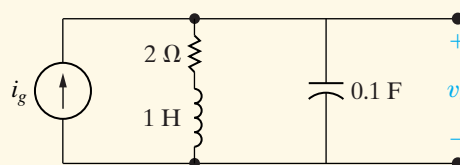
$$-z_1 = -5000.$$

### ✓ ASSESSMENT PROBLEM

**Objective 3—Understand the definition and significance of the transfer function; be able to derive a transfer function**

- 13.9 a) Derive the numerical expression for the transfer function  $V_o/I_g$  for the circuit shown.  
 b) Give the numerical value of each pole and zero of  $H(s)$ .

**Answer:** (a)  $H(s) = 10(s + 2)/(s^2 + 2s + 10)$ ;  
 (b)  $-p_1 = -1 + j3$ ,  $-p_2 = -1 - j3$ ,  
 $-z = -2$ .



*NOTE: Also try Chapter Problem 13.52.*

### The Location of Poles and Zeros of $H(s)$

For linear lumped-parameter circuits,  $H(s)$  is always a rational function of  $s$ . Complex poles and zeros always appear in conjugate pairs. The poles of  $H(s)$  must lie in the left half of the  $s$  plane if the response to a bounded source (one whose values lie within some finite bounds) is to be bounded. The zeros of  $H(s)$  may lie in either the right half or the left half of the  $s$  plane.

With these general characteristics in mind, we next discuss the role that  $H(s)$  plays in determining the response function. We begin with the partial fraction expansion technique for finding  $y(t)$ .

## 13.5 The Transfer Function in Partial Fraction Expansions

From Eq. 13.93 we can write the circuit output as the product of the transfer function and the driving function:

$$Y(s) = H(s)X(s). \quad (13.96)$$

We have already noted that  $H(s)$  is a rational function of  $s$ . Reference to Table 13.1 shows that  $X(s)$  also is a rational function of  $s$  for the excitation functions of most interest in circuit analysis.

Expanding the right-hand side of Eq. 13.96 into a sum of partial fractions produces a term for each pole of  $H(s)$  and  $X(s)$ . Remember from Chapter 12 that poles are the roots of the denominator polynomial; zeros are the roots of the numerator polynomial. The terms generated by the poles of  $H(s)$  give rise to the transient component of the total response, whereas the terms generated by the poles of  $X(s)$  give rise to the steady-state component of the response. By steady-state response, we mean the response that exists after the transient components have become negligible. Example 13.2 illustrates these general observations.



**Example 13.2 Analyzing the Transfer Function of a Circuit**

The circuit in Example 13.1 (Fig. 13.31) is driven by a voltage source whose voltage increases linearly with time, namely,  $v_g = 50tu(t)$ .

- Use the transfer function to find  $v_o$ .
- Identify the transient component of the response.
- Identify the steady-state component of the response.
- Sketch  $v_o$  versus  $t$  for  $0 \leq t \leq 1.5$  ms.

**Solution**

a) From Example 13.1,

$$H(s) = \frac{1000(s + 5000)}{s^2 + 6000s + 25 \times 10^6}.$$

The transform of the driving voltage is  $50/s^2$ ; therefore, the  $s$ -domain expression for the output voltage is

$$V_o = \frac{1000(s + 5000)}{(s^2 + 6000s + 25 \times 10^6)} \frac{50}{s^2}.$$

The partial fraction expansion of  $V_o$  is

$$V_o = \frac{K_1}{s + 3000 - j4000} + \frac{K_1^*}{s + 3000 + j4000} + \frac{K_2}{s^2} + \frac{K_3}{s}.$$

We evaluate the coefficients  $K_1$ ,  $K_2$ , and  $K_3$  by using the techniques described in Section 12.7:

$$K_1 = 5\sqrt{5} \times 10^{-4} \angle 79.70^\circ;$$

$$K_1^* = 5\sqrt{5} \times 10^{-4} \angle -79.70^\circ,$$

$$K_2 = 10,$$

$$K_3 = -4 \times 10^{-4}.$$

The time-domain expression for  $v_o$  is

$$v_o = [10\sqrt{5} \times 10^{-4} e^{-3000t} \cos(4000t + 79.70^\circ) + 10t - 4 \times 10^{-4}]u(t) \text{ V.}$$

b) The transient component of  $v_o$  is

$$10\sqrt{5} \times 10^{-4} e^{-3000t} \cos(4000t + 79.70^\circ).$$

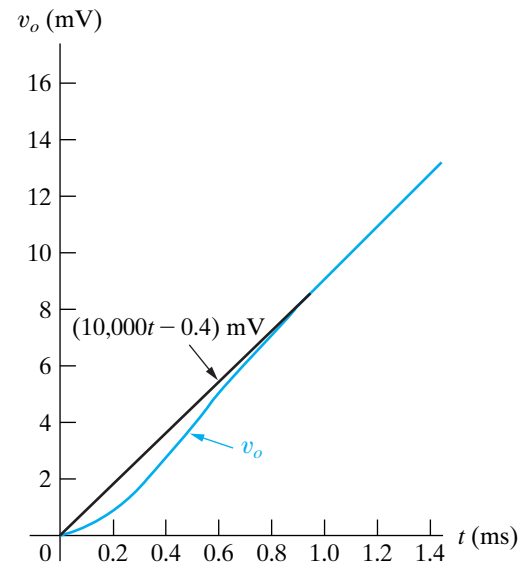
Note that this term is generated by the poles  $(-3000 + j4000)$  and  $(-3000 - j4000)$  of the transfer function.

c) The steady-state component of the response is

$$(10t - 4 \times 10^{-4})u(t).$$

These two terms are generated by the second-order pole ( $K/s^2$ ) of the driving voltage.

d) Figure 13.33 shows a sketch of  $v_o$  versus  $t$ . Note that the deviation from the steady-state solution  $10,000t - 0.4$  mV is imperceptible after approximately 1 ms.



**Figure 13.33** ▲ The graph of  $v_o$  versus  $t$  for Example 13.2.

## ✓ ASSESSMENT PROBLEMS

**Objective 4—Know how to use a circuit's transfer function to calculate the circuit's impulse response, unit step response, and steady-state response to sinusoidal input**

**13.10** Find (a) the unit step and (b) the unit impulse response of the circuit shown in Assessment Problem 13.9.

**Answer:** (a)  $[2 + (10/3)e^{-t} \cos(3t - 126.87^\circ)]u(t)$  V;  
(b)  $10.54e^{-t} \cos(3t - 18.43^\circ)u(t)$  V.

*NOTE:* Also try Chapter Problems 13.77(a) and (b).

**13.11** The unit impulse response of a circuit is

$$v_o(t) = 10,000e^{-70t} \cos(240t + \theta) \text{ V},$$

where  $\tan \theta = \frac{7}{24}$ .

- Find the transfer function of the circuit.
- Find the unit step response of the circuit.

**Answer:** (a)  $9600s/(s^2 + 140s + 62,500)$ ;  
(b)  $40e^{-70t} \sin 240t$  V.

## Observations on the Use of $H(s)$ in Circuit Analysis

Example 13.2 clearly shows how the transfer function  $H(s)$  relates to the response of a circuit through a partial fraction expansion. However, the example raises questions about the practicality of driving a circuit with an increasing ramp voltage that generates an increasing ramp response. Eventually the circuit components will fail under the stress of excessive voltage, and when that happens our linear model is no longer valid. The ramp response is of interest in practical applications where the ramp function increases to a maximum value over a finite time interval. If the time taken to reach this maximum value is long compared with the time constants of the circuit, the solution assuming an unbounded ramp is valid for this finite time interval.

We make two additional observations regarding Eq. 13.96. First, let's look at the response of the circuit due to a delayed input. If the input is delayed by  $a$  seconds,

$$\mathcal{L}\{x(t - a)u(t - a)\} = e^{-as}X(s),$$

and, from Eq. 13.96, the response becomes

$$Y(s) = H(s)X(s)e^{-as}. \quad (13.97)$$

If  $y(t) = \mathcal{L}^{-1}\{H(s)X(s)\}$ , then, from Eq. 13.97,

$$y(t - a)u(t - a) = \mathcal{L}^{-1}\{H(s)X(s)e^{-as}\}. \quad (13.98)$$

Therefore, delaying the input by  $a$  seconds simply delays the response function by  $a$  seconds. A circuit that exhibits this characteristic is said to be **time invariant**.

Second, if a unit impulse source drives the circuit, the response of the circuit equals the inverse transform of the transfer function. Thus if

$$x(t) = \delta(t), \quad \text{then } X(s) = 1$$

and

$$Y(s) = H(s). \quad (13.99)$$

Hence, from Eq. 13.99,

$$y(t) = h(t), \quad (13.100)$$

where the inverse transform of the transfer function equals the unit impulse response of the circuit. Note that this is also the natural response of the circuit because the application of an impulsive source is equivalent to instantaneously storing energy in the circuit (see Section 13.8). The subsequent release of this stored energy gives rise to the natural response (see Problem 13.82).

Actually, the unit impulse response of a circuit,  $h(t)$ , contains enough information to compute the response to any source that drives the circuit. The convolution integral is used to extract the response of a circuit to an arbitrary source as demonstrated in the next section.

## 13.6 The Transfer Function and the Convolution Integral

The convolution integral relates the output  $y(t)$  of a linear time-invariant circuit to the input  $x(t)$  of the circuit and the circuit's impulse response  $h(t)$ . The integral relationship can be expressed in two ways:

$$y(t) = \int_{-\infty}^{\infty} h(\lambda)x(t - \lambda)d\lambda = \int_{-\infty}^{\infty} h(t - \lambda)x(\lambda)d\lambda. \quad (13.101)$$

We are interested in the convolution integral for several reasons. First, it allows us to work entirely in the time domain. Doing so may be beneficial in situations where  $x(t)$  and  $h(t)$  are known only through experimental data. In such cases, the transform method may be awkward or even impossible, as it would require us to compute the Laplace transform of experimental data. Second, the convolution integral introduces the concepts of memory and the weighting function into analysis. We will show how the concept of memory enables us to look at the impulse response (or the weighting function)  $h(t)$  and predict, to some degree, how closely the output waveform replicates the input waveform. Finally, the convolution integral provides a formal procedure for finding the inverse transform of products of Laplace transforms.

We based the derivation of Eq. 13.101 on the assumption that the circuit is linear and time invariant. Because the circuit is linear, the principle of superposition is valid, and because it is time invariant, the amount of the response delay is exactly the same as that of the input delay. Now consider Fig. 13.34, in which the block containing  $h(t)$  represents any linear time-invariant circuit whose impulse response is known,  $x(t)$  represents the excitation signal and  $y(t)$  represents the desired output signal.

We assume that  $x(t)$  is the general excitation signal shown in Fig. 13.35(a). For convenience we also assume that  $x(t) = 0$  for  $t < 0^-$ . Once you see the derivation of the convolution integral assuming  $x(t) = 0$  for  $t < 0^-$ , the extension of the integral to include excitation functions that exist over all time becomes apparent. Note also that we permit a discontinuity in  $x(t)$  at the origin, that is, a jump between  $0^-$  and  $0^+$ .

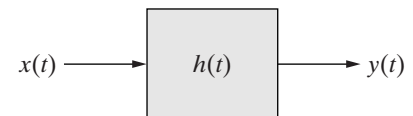
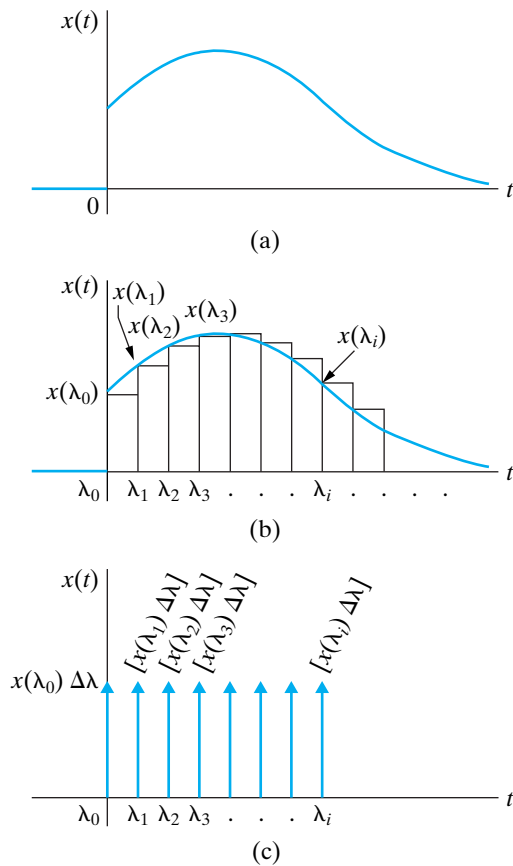


Figure 13.34 ▲ A block diagram of a general circuit.



**Figure 13.35** ▲ The excitation signal of  $x(t)$ . (a) A general excitation signal. (b) Approximating  $x(t)$  with a series of pulses. (c) Approximating  $x(t)$  with a series of impulses.

Now we approximate  $x(t)$  by a series of rectangular pulses of uniform width  $\Delta\lambda$ , as shown in Fig. 13.35(b). Thus

$$x(t) = x_0(t) + x_1(t) + \dots + x_i(t) + \dots, \quad (13.102)$$

where  $x_i(t)$  is a rectangular pulse that equals  $x(\lambda_i)$  between  $\lambda_i$  and  $\lambda_{i+1}$  and is zero elsewhere. Note that the  $i$ th pulse can be expressed in terms of step functions; that is,

$$x_i(t) = x(\lambda_i)\{u(t - \lambda_i) - u[t - (\lambda_i + \Delta\lambda)]\}.$$

The next step in the approximation of  $x(t)$  is to make  $\Delta\lambda$  small enough that the  $i$ th component can be approximated by an impulse function of strength  $x(\lambda_i)\Delta\lambda$ . Figure 13.35(c) shows the impulse representation, with the strength of each impulse shown in brackets beside each arrow. The impulse representation of  $x(t)$  is

$$x(t) = x(\lambda_0)\Delta\lambda\delta(t - \lambda_0) + x(\lambda_1)\Delta\lambda\delta(t - \lambda_1) + \dots + x(\lambda_i)\Delta\lambda\delta(t - \lambda_i) + \dots \quad (13.103)$$

Now when  $x(t)$  is represented by a series of impulse functions (which occur at equally spaced intervals of time, that is, at  $\lambda_0, \lambda_1, \lambda_2, \dots$ ), the response function  $y(t)$  consists of the sum of a series of uniformly delayed impulse responses. The strength of each response depends on the strength of the impulse driving the circuit. For example, let's assume that the unit impulse response of the circuit contained in the box in Fig. 13.34 is the exponential decay function shown in Fig. 13.36(a). Then the approximation of  $y(t)$  is the sum of the impulse responses shown in Fig. 13.36(b).

Analytically, the expression for  $y(t)$  is

$$y(t) = x(\lambda_0)\Delta\lambda h(t - \lambda_0) + x(\lambda_1)\Delta\lambda h(t - \lambda_1) + x(\lambda_2)\Delta\lambda h(t - \lambda_2) + \dots + x(\lambda_i)\Delta\lambda h(t - \lambda_i) + \dots \quad (13.104)$$

As  $\Delta\lambda \rightarrow 0$ , the summation in Eq. 13.104 approaches a continuous integration, or

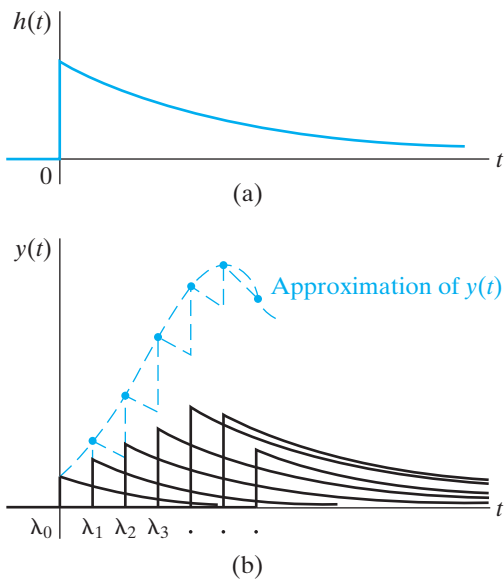
$$\sum_{i=0}^{\infty} x(\lambda_i)h(t - \lambda_i)\Delta\lambda \rightarrow \int_0^{\infty} x(\lambda)h(t - \lambda)d\lambda. \quad (13.105)$$

Therefore,

$$y(t) = \int_0^{\infty} x(\lambda)h(t - \lambda)d\lambda. \quad (13.106)$$

If  $x(t)$  exists over all time, then the lower limit on Eq. 13.106 becomes  $-\infty$ ; thus, in general,

$$y(t) = \int_{-\infty}^{\infty} x(\lambda)h(t - \lambda)d\lambda, \quad (13.107)$$



**Figure 13.36** ▲ The approximation of  $y(t)$ . (a) The impulse response of the box shown in Fig. 13.34. (b) Summing the impulse responses.

which is the second form of the convolution integral given in Eq. 13.101. We derive the first form of the integral from Eq. 13.107 by making a change in the variable of integration. We let  $u = t - \lambda$ , and then we note that  $du = -d\lambda$ ,  $u = -\infty$  when  $\lambda = \infty$ , and  $u = +\infty$  when  $\lambda = -\infty$ . Now we can write Eq. 13.107 as

$$y(t) = \int_{\infty}^{-\infty} x(t - u)h(u)(-du),$$

or

$$y(t) = \int_{-\infty}^{\infty} x(t - u)h(u)(du). \tag{13.108}$$

But because  $u$  is just a symbol of integration, Eq. 13.108 is equivalent to the first form of the convolution integral, Eq. 13.101.

The integral relationship between  $y(t)$ ,  $h(t)$ , and  $x(t)$ , expressed in Eq. 13.101, often is written in a shorthand notation:

$$y(t) = h(t) * x(t) = x(t) * h(t), \tag{13.109}$$

where the asterisk signifies the integral relationship between  $h(t)$  and  $x(t)$ . Thus  $h(t) * x(t)$  is read as “ $h(t)$  is convolved with  $x(t)$ ” and implies that

$$h(t) * x(t) = \int_{-\infty}^{\infty} h(\lambda)x(t - \lambda) d\lambda,$$

whereas  $x(t) * h(t)$  is read as “ $x(t)$  is convolved with  $h(t)$ ” and implies that

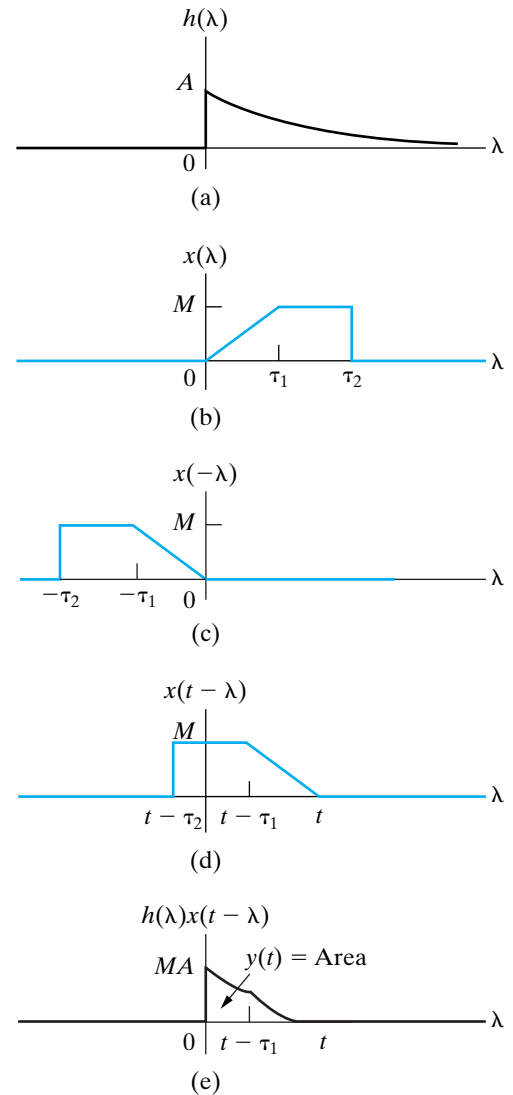
$$x(t) * h(t) = \int_{-\infty}^{\infty} x(\lambda)h(t - \lambda) d\lambda.$$

The integrals in Eq. 13.101 give the most general relationship for the convolution of two functions. However, in our applications of the convolution integral, we can change the lower limit to zero and the upper limit to  $t$ . Then we can write Eq. 13.101 as

$$y(t) = \int_0^t h(\lambda)x(t - \lambda) d\lambda = \int_0^t x(\lambda)h(t - \lambda) d\lambda. \tag{13.110}$$

We change the limits for two reasons. First, for physically realizable circuits,  $h(t)$  is zero for  $t < 0$ . In other words, there can be no impulse response before an impulse is applied. Second, we start measuring time at the instant the excitation  $x(t)$  is turned on; therefore  $x(t) = 0$  for  $t < 0^-$ .

A graphic interpretation of the convolution integrals contained in Eq. 13.110 is important in the use of the integral as a computational tool. We begin with the first integral. For purposes of discussion, we assume that the impulse response of our circuit is the exponential decay function shown in Fig. 13.37(a) and that the excitation function has the waveform shown in Fig. 13.37(b). In each of these plots, we replaced  $t$  with  $\lambda$ , the symbol of integration. Replacing  $\lambda$  with  $-\lambda$  simply folds the excitation function over the vertical axis, and replacing  $-\lambda$  with  $t - \lambda$  slides the folded function to the right. See Figures 13.37(c) and (d). This

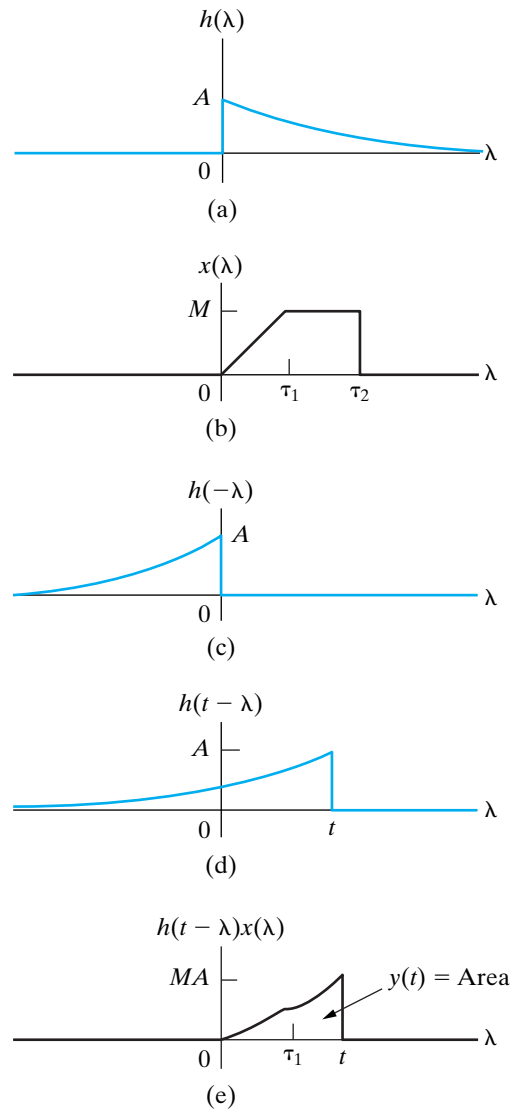


**Figure 13.37** ▲ A graphic interpretation of the convolution integral  $\int_0^t h(\lambda)x(t - \lambda) d\lambda$ . (a) The impulse response. (b) The excitation function. (c) The folded excitation function. (d) The folded excitation function displaced  $t$  units. (e) The product  $h(\lambda)x(t - \lambda)$ .

folding operation gives rise to the term *convolution*. At any specified value of  $t$ , the response function  $y(t)$  is the area under the product function  $h(\lambda)x(t - \lambda)$ , as shown in Fig. 13.37(e). It should be apparent from this plot why the lower limit on the convolution integral is zero and the upper limit is  $t$ . For  $\lambda < 0$ , the product  $h(\lambda)x(t - \lambda)$  is zero because  $h(\lambda)$  is zero. For  $\lambda > t$ , the product  $h(\lambda)x(t - \lambda)$  is zero because  $x(t - \lambda)$  is zero.

Figure 13.38 shows the second form of the convolution integral. Note that the product function in Fig. 13.38(e) confirms the use of zero for the lower limit and  $t$  for the upper limit.

Example 13.3 illustrates how to use the convolution integral, in conjunction with the unit impulse response, to find the response of a circuit.

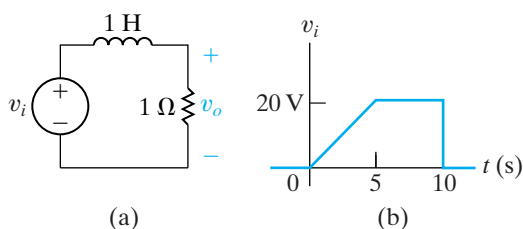


**Figure 13.38** ▲ A graphic interpretation of the convolution integral  $\int_0^t h(t - \lambda)x(\lambda) d\lambda$ . (a) The impulse response. (b) The excitation function. (c) The folded impulse response. (d) The folded impulse response displaced  $t$  units. (e) The product  $h(t - \lambda)x(\lambda)$ .

**Example 13.3** Using the Convolution Integral to Find an Output Signal

The excitation voltage  $v_i$  for the circuit shown in Fig. 13.39(a) is shown in Fig. 13.39(b).

- Use the convolution integral to find  $v_o$ .
- Plot  $v_o$  over the range of  $0 \leq t \leq 15$  s.



**Figure 13.39** ▲ The circuit and excitation voltage for Example 13.3. (a) The circuit. (b) The excitation voltage.

**Solution**

- The first step in using the convolution integral is to find the unit impulse response of the circuit. We obtain the expression for  $V_o$  from the  $s$ -domain equivalent of the circuit in Fig. 13.39(a):

$$V_o = \frac{V_i}{s + 1} (1).$$

When  $v_i$  is a unit impulse function  $\delta(t)$ ,

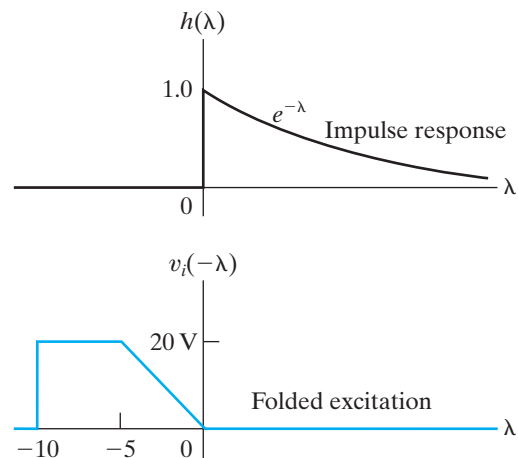
$$v_o = h(t) = e^{-t}u(t),$$

from which

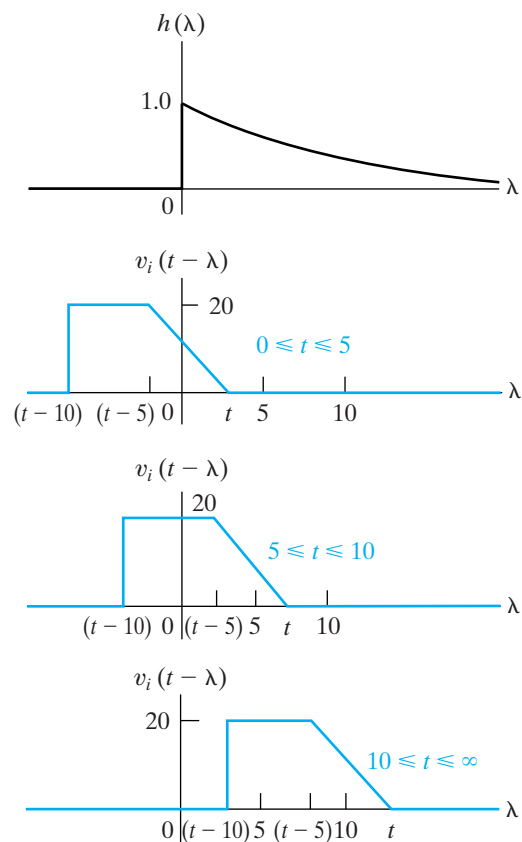
$$h(\lambda) = e^{-\lambda}u(\lambda).$$

Using the first form of the convolution integral in Eq. 13.110, we construct the impulse response and folded excitation function shown in Fig. 13.40, which are helpful in selecting the limits on the convolution integral. Sliding the folded excitation function to the right requires breaking the integration into three intervals:  $0 \leq t \leq 5$ ;  $5 \leq t \leq 10$ ; and  $10 \leq t \leq \infty$ . The breaks in the excitation function at 0, 5, and 10 s dictate these break points. Figure 13.41 shows the positioning of the folded excitation for each of these intervals. The analytical expression for  $v_i$  in the time interval  $0 \leq t \leq 5$  is

$$v_i = 4t, \quad 0 \leq t \leq 5 \text{ s.}$$



**Figure 13.40** ▲ The impulse response and the folded excitation function for Example 13.3.



**Figure 13.41** ▲ The displacement of  $v_i(t - \lambda)$  for three different time intervals.



Hence, the analytical expression for the folded excitation function in the interval  $t - 5 \leq \lambda \leq t$  is

$$v_i(t - \lambda) = 4(t - \lambda), \quad t - 5 \leq \lambda \leq t.$$

We can now set up the three integral expressions for  $v_o$ . For  $0 \leq t \leq 5$  s:

$$\begin{aligned} v_o &= \int_0^t 4(t - \lambda)e^{-\lambda} d\lambda \\ &= 4(e^{-t} + t - 1) \text{ V.} \end{aligned}$$

For  $5 \leq t \leq 10$  s,

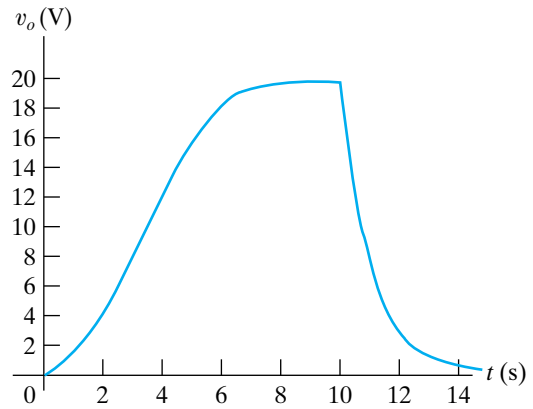
$$\begin{aligned} v_o &= \int_0^{t-5} 20e^{-\lambda} d\lambda + \int_{t-5}^t 4(t - \lambda)e^{-\lambda} d\lambda \\ &= 4(5 + e^{-t} - e^{-(t-5)}) \text{ V.} \end{aligned}$$

And for  $10 \leq t \leq \infty$  s,

$$\begin{aligned} v_o &= \int_{t-10}^{t-5} 20e^{-\lambda} d\lambda + \int_{t-5}^t 4(t - \lambda)e^{-\lambda} d\lambda \\ &= 4(e^{-t} - e^{-(t-5)} + 5e^{-(t-10)}) \text{ V.} \end{aligned}$$

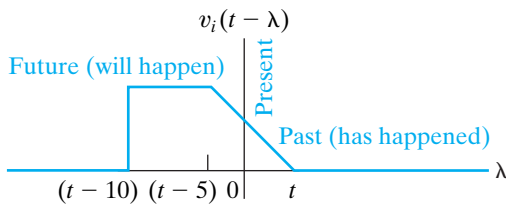
b) We have computed  $v_o$  for 1 s intervals of time, using the appropriate equation. The results are tabulated in Table 13.2 and shown graphically in Fig. 13.42.

*NOTE: Assess your understanding of convolution by trying Chapter Problems 13.52 and 13.60.*



**Figure 13.42** ▲ The voltage response versus time for Example 13.3.

TABLE 13.2 Numerical Values of $v_o(t)$			
$t$	$v_o$	$t$	$v_o$
1	1.47	9	19.93
2	4.54	10	19.97
3	8.20	11	7.35
4	12.07	12	2.70
5	16.03	13	0.99
6	18.54	14	0.37
7	19.56	15	0.13
8	19.80		



**Figure 13.43** ▲ The past, present, and future values of the excitation function.

### The Concepts of Memory and the Weighting Function

We mentioned at the beginning of this section that the convolution integral introduces the concepts of memory and the weighting function into circuit analysis. The graphic interpretation of the convolution integral is the easiest way to begin to grasp these concepts. We can view the folding and sliding of the excitation function on a timescale characterized as past, present, and future. The vertical axis, over which the excitation function  $x(t)$  is folded, represents the present value; past values of  $x(t)$  lie to the right of the vertical axis, and future values lie to the left. Figure 13.43 shows this description of  $x(t)$ . For illustrative purposes, we used the excitation function from Example 13.3.

When we combine the past, present, and future views of  $x(t - \tau)$  with the impulse response of the circuit, we see that the impulse response weights  $x(t)$  according to present and past values. For example, Fig. 13.41 shows that the impulse response in Example 13.3 gives less weight to past values of  $x(t)$  than to the present value of  $x(t)$ . In other words, the circuit retains less and less about past input values. Therefore, in Fig. 13.42,  $v_o$  quickly approaches zero when the present value of the input is zero (that is, when  $t > 10$  s). In other words, because the present value of the input receives more weight than the past values, the output quickly approaches the present value of the input.

The multiplication of  $x(t - \lambda)$  by  $h(\lambda)$  gives rise to the practice of referring to the impulse response as the circuit **weighting function**. The weighting function, in turn, determines how much memory the circuit has. **Memory** is the extent to which the circuit's response matches its input. For example, if the impulse response, or weighting function, is flat, as shown in Fig. 13.44(a), it gives equal weight to all values of  $x(t)$ , past and present. Such a circuit has a perfect memory. However, if the impulse response is an impulse function, as shown in Fig. 13.44(b), it gives no weight to past values of  $x(t)$ . Such a circuit has no memory. Thus the more memory a circuit has, the more distortion there is between the waveform of the excitation function and the waveform of the response function. We can show this relationship by assuming that the circuit has no memory, that is,  $h(t) = A\delta(t)$ , and then noting from the convolution integral that

$$\begin{aligned} y(t) &= \int_0^t h(\lambda)x(t - \lambda)d\lambda \\ &= \int_0^t A\delta(\lambda)x(t - \lambda)d\lambda \\ &= Ax(t). \end{aligned} \quad (13.111)$$

Equation 13.111 shows that, if the circuit has no memory, the output is a scaled replica of the input.

The circuit shown in Example 13.3 illustrates the distortion between input and output for a circuit that has some memory. This distortion is clear when we plot the input and output waveforms on the same graph, as in Fig. 13.45.

## 13.7 The Transfer Function and the Steady-State Sinusoidal Response

Once we have computed a circuit's transfer function, we no longer need to perform a separate phasor analysis of the circuit to determine its steady-state response. Instead, we use the transfer function to relate the steady-state response to the excitation source. First we assume that

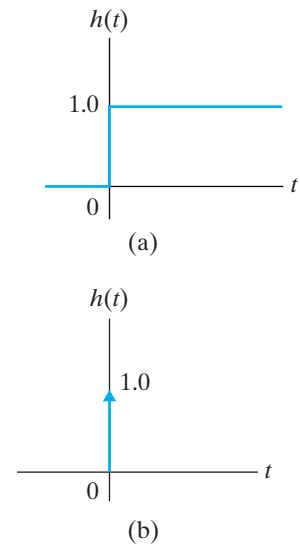
$$x(t) = A \cos(\omega t + \phi), \quad (13.112)$$

and then we use Eq. 13.96 to find the steady-state solution of  $y(t)$ . To find the Laplace transform of  $x(t)$ , we first write  $x(t)$  as

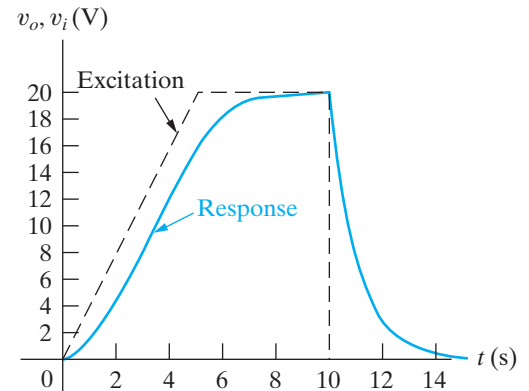
$$x(t) = A \cos \omega t \cos \phi - A \sin \omega t \sin \phi, \quad (13.113)$$

from which

$$\begin{aligned} X(s) &= \frac{(A \cos \phi)s}{s^2 + \omega^2} - \frac{(A \sin \phi)\omega}{s^2 + \omega^2} \\ &= \frac{A(s \cos \phi - \omega \sin \phi)}{s^2 + \omega^2}. \end{aligned} \quad (13.114)$$



**Figure 13.44** ▲ Weighting functions. (a) Perfect memory. (b) No memory.



**Figure 13.45** ▲ The input and output waveforms for Example 13.3.

Substituting Eq. 13.114 into Eq. 13.96 gives the  $s$ -domain expression for the response:

$$Y(s) = H(s) \frac{A(s \cos \phi - \omega \sin \phi)}{s^2 + \omega^2}. \quad (13.115)$$

We now visualize the partial fraction expansion of Eq. 13.115. The number of terms in the expansion depends on the number of poles of  $H(s)$ . Because  $H(s)$  is not specified beyond being the transfer function of a physically realizable circuit, the expansion of Eq. 13.115 is

$$Y(s) = \frac{K_1}{s - j\omega} + \frac{K_1^*}{s + j\omega} + \sum \text{terms generated by the poles of } H(s). \quad (13.116)$$

In Eq. 13.116, the first two terms result from the complex conjugate poles of the driving source; that is,  $s^2 + \omega^2 = (s - j\omega)(s + j\omega)$ . However, the terms generated by the poles of  $H(s)$  do not contribute to the steady-state response of  $y(t)$ , because all these poles lie in the left half of the  $s$  plane; consequently, the corresponding time-domain terms approach zero as  $t$  increases. Thus the first two terms on the right-hand side of Eq. 13.116 determine the steady-state response. The problem is reduced to finding the partial fraction coefficient  $K_1$ :

$$\begin{aligned} K_1 &= \left. \frac{H(s)A(s \cos \phi - \omega \sin \phi)}{s + j\omega} \right|_{s=j\omega} \\ &= \frac{H(j\omega)A(j\omega \cos \phi - \omega \sin \phi)}{2j\omega} \\ &= \frac{H(j\omega)A(\cos \phi + j \sin \phi)}{2} = \frac{1}{2}H(j\omega)Ae^{j\phi}. \end{aligned} \quad (13.117)$$

In general,  $H(j\omega)$  is a complex quantity, which we recognize by writing it in polar form; thus

$$H(j\omega) = |H(j\omega)|e^{j\theta(\omega)}. \quad (13.118)$$

Note from Eq. 13.118 that both the magnitude,  $|H(j\omega)|$ , and phase angle,  $\theta(\omega)$ , of the transfer function vary with the frequency  $\omega$ . When we substitute Eq. 13.118 into Eq. 13.117, the expression for  $K_1$  becomes

$$K_1 = \frac{A}{2}|H(j\omega)|e^{j[\theta(\omega)+\phi]}. \quad (13.119)$$

We obtain the steady-state solution for  $y(t)$  by inverse-transforming Eq. 13.116 and, in the process, ignoring the terms generated by the poles of  $H(s)$ . Thus

**Steady-state sinusoidal response computed using a transfer function ►**

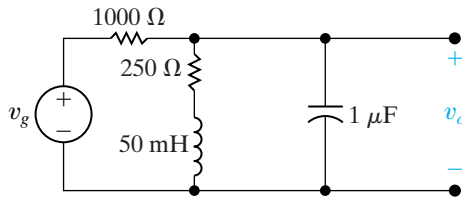
$$y_{ss}(t) = A|H(j\omega)| \cos[\omega t + \phi + \theta(\omega)], \quad (13.120)$$

which indicates how to use the transfer function to find the steady-state sinusoidal response of a circuit. The amplitude of the response equals the amplitude of the source,  $A$ , times the magnitude of the transfer function,  $|H(j\omega)|$ . The phase angle of the response,  $\phi + \theta(\omega)$ , equals the phase angle of the source,  $\phi$ , plus the phase angle of the transfer function,  $\theta(\omega)$ . We evaluate both  $|H(j\omega)|$  and  $\theta(\omega)$  at the frequency of the source,  $\omega$ .

Example 13.4 illustrates how to use the transfer function to find the steady-state sinusoidal response of a circuit.

**Example 13.4 Using the Transfer Function to Find the Steady-State Sinusoidal Response**

The circuit from Example 13.1 is shown in Fig. 13.46. The sinusoidal source voltage is  $120 \cos(5000t + 30^\circ)$  V. Find the steady-state expression for  $v_o$ .



**Figure 13.46** ▲ The circuit for Example 13.4.

**Solution**

From Example 13.1,

$$H(s) = \frac{1000(s + 5000)}{s^2 + 6000s + 25 \times 10^6}$$

The frequency of the voltage source is 5000 rad/s; hence we evaluate  $H(s)$  at  $H(j5000)$ :

$$\begin{aligned} H(j5000) &= \frac{1000(5000 + j5000)}{-25 \times 10^6 + j5000(6000) + 25 \times 10^6} \\ &= \frac{1 + j1}{j6} = \frac{1 - j1}{6} = \frac{\sqrt{2}}{6} \angle -45^\circ. \end{aligned}$$

Then, from Eq. 13.120,

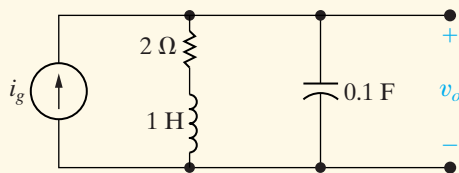
$$\begin{aligned} v_{o_{ss}} &= \frac{(120)\sqrt{2}}{6} \cos(5000t + 30^\circ - 45^\circ) \\ &= 20\sqrt{2} \cos(5000t - 15^\circ) \text{ V.} \end{aligned}$$

The ability to use the transfer function to calculate the steady-state sinusoidal response of a circuit is important. Note that if we know  $H(j\omega)$ , we also know  $H(s)$ , at least theoretically. In other words, we can reverse the process; instead of using  $H(s)$  to find  $H(j\omega)$ , we use  $H(j\omega)$  to find  $H(s)$ . Once we know  $H(s)$ , we can find the response to other excitation sources. In this application, we determine  $H(j\omega)$  experimentally and then construct  $H(s)$  from the data. Practically, this experimental approach is not always possible; however, in some cases it does provide a useful method for deriving  $H(s)$ . In theory, the relationship between  $H(s)$  and  $H(j\omega)$  provides a link between the time domain and the frequency domain. The transfer function is also a very useful tool in problems concerning the frequency response of a circuit, a concept we introduce in the next chapter.

**ASSESSMENT PROBLEMS**

**Objective 4—Know how to use a circuit's transfer function to calculate the circuit's impulse response, unit step response, and steady-state response to sinusoidal input**

**13.12** The current source in the circuit shown is delivering  $10 \cos 4t$  A. Use the transfer function to compute the steady-state expression for  $v_o$ .

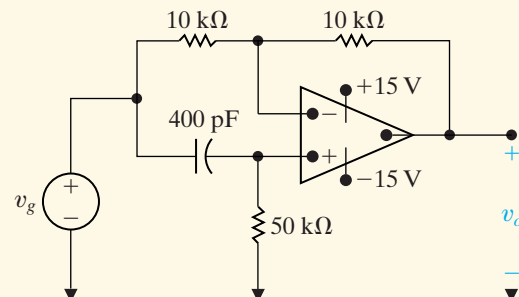


**Answer:**  $44.7 \cos(4t - 63.43^\circ)$  V.

**13.13** a) For the circuit shown, find the steady-state expression for  $v_o$  when  $v_g = 10 \cos 50,000t$  V.

**NOTE:** Also try Chapter Problems 13.76 and 13.78.

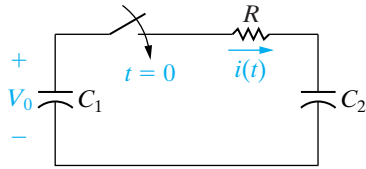
b) Replace the  $50 \text{ k}\Omega$  resistor with a variable resistor and compute the value of resistance necessary to cause  $v_o$  to lead  $v_g$  by  $120^\circ$ .



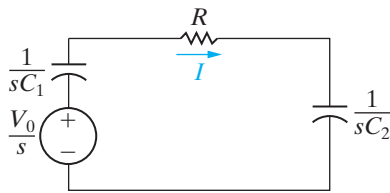
**Answer:** (a)  $10 \cos(50,000t + 90^\circ)$  V;  
 (b)  $28,867.51 \text{ }\Omega$ .

## 13.8 The Impulse Function in Circuit Analysis

Impulse functions occur in circuit analysis either because of a switching operation or because a circuit is excited by an impulsive source. The Laplace transform can be used to predict the impulsive currents and voltages created during switching and the response of a circuit to an impulsive source. We begin our discussion by showing how to create an impulse function with a switching operation.



**Figure 13.47** ▲ A circuit showing the creation of an impulsive current.



**Figure 13.48** ▲ The *s*-domain equivalent circuit for the circuit shown in Fig. 13.47.

### Switching Operations

We use two different circuits to illustrate how an impulse function can be created with a switching operation: a capacitor circuit, and a series inductor circuit.

#### Capacitor Circuit

In the circuit shown in Fig. 13.47, the capacitor  $C_1$  is charged to an initial voltage of  $V_0$  at the time the switch is closed. The initial charge on  $C_2$  is zero. The problem is to find the expression for  $i(t)$  as  $R \rightarrow 0$ . Figure 13.48 shows the *s*-domain equivalent circuit.

From Fig. 13.48,

$$I = \frac{V_0/s}{R + (1/sC_1) + (1/sC_2)} = \frac{V_0/R}{s + (1/RC_e)}, \tag{13.121}$$

where the equivalent capacitance  $C_1C_2/(C_1 + C_2)$  is replaced by  $C_e$ .

We inverse-transform Eq. 13.121 by inspection to obtain

$$i = \left( \frac{V_0}{R} e^{-t/RC_e} \right) u(t), \tag{13.122}$$

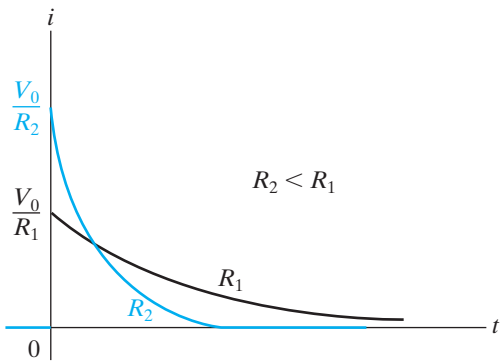
which indicates that as  $R$  decreases, the initial current ( $V_0/R$ ) increases and the time constant ( $RC_e$ ) decreases. Thus, as  $R$  gets smaller, the current starts from a larger initial value and then drops off more rapidly. Figure 13.49 shows these characteristics of  $i$ .

Apparently  $i$  is approaching an impulse function as  $R$  approaches zero because the initial value of  $i$  is approaching infinity and the duration of  $i$  is approaching zero. We still have to determine whether the area under the current function is independent of  $R$ . Physically, the total area under the  $i$  versus  $t$  curve represents the total charge transferred to  $C_2$  after the switch is closed. Thus

$$\text{Area} = q = \int_0^\infty \frac{V_0}{R} e^{-t/RC_e} dt = V_0 C_e, \tag{13.123}$$

which says that the total charge transferred to  $C_2$  is independent of  $R$  and equals  $V_0 C_e$  coulombs. Thus, as  $R$  approaches zero, the current approaches an impulse strength  $V_0 C_e$ ; that is,

$$i \rightarrow V_0 C_e \delta(t). \tag{13.124}$$



**Figure 13.49** ▲ The plot of  $i(t)$  versus  $t$  for two different values of  $R$ .

The physical interpretation of Eq. 13.124 is that when  $R = 0$ , a finite amount of charge is transferred to  $C_2$  instantaneously. Making  $R$  zero in the circuit shown in Fig. 13.47 shows why we get an instantaneous transfer of charge. With  $R = 0$ , we create a contradiction when we close the switch; that is, we apply a voltage across a capacitor that has a zero initial voltage. The only way to have an instantaneous change in capacitor voltage is to have an instantaneous transfer of charge. When the switch is closed, the voltage across  $C_2$  does not jump to  $V_0$  but to its final value of

$$v_2 = \frac{C_1 V_0}{C_1 + C_2}. \quad (13.125)$$

We leave the derivation of Eq. 13.125 to you (see Problem 13.81).

If we set  $R$  equal to zero at the outset, the Laplace transform analysis will predict the impulsive current response. Thus,

$$I = \frac{V_0/s}{(1/sC_1) + (1/sC_2)} = \frac{C_1 C_2 V_0}{C_1 + C_2} = C_e V_0. \quad (13.126)$$

In writing Eq. 13.126, we use the capacitor voltages at  $t = 0^-$ . The inverse transform of a constant is the constant times the impulse function; therefore, from Eq. 13.126,

$$i = C_e V_0 \delta(t). \quad (13.127)$$

The ability of the Laplace transform to predict correctly the occurrence of an impulsive response is one reason why the transform is widely used to analyze the transient behavior of linear lumped-parameter time-invariant circuits.

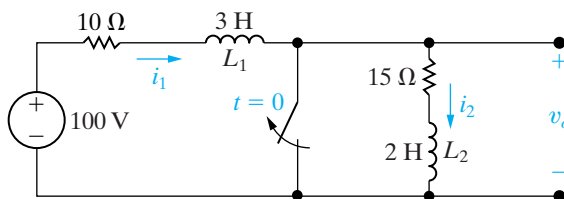
### Series Inductor Circuit

The circuit shown in Fig. 13.50 illustrates a second switching operation that produces an impulsive response. The problem is to find the time-domain expression for  $v_o$  after the switch has been opened. Note that opening the switch forces an instantaneous change in the current of  $L_2$ , which causes  $v_o$  to contain an impulsive component.

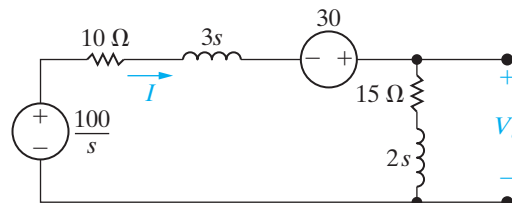
Figure 13.51 shows the  $s$ -domain equivalent with the switch open. In deriving this circuit, we recognized that the current in the 3 H inductor at  $t = 0^-$  is 10 A, and the current in the 2 H inductor at  $t = 0^-$  is zero. Using the initial conditions at  $t = 0^-$  is a direct consequence of our using  $0^-$  as the lower limit on the defining integral of the Laplace transform.

We derive the expression for  $V_o$  from a single node-voltage equation. Summing the currents away from the node between the 15  $\Omega$  resistor and the 30 V source gives

$$\frac{V_o}{2s + 15} + \frac{V_o - [(100/s) + 30]}{3s + 10} = 0. \quad (13.128)$$



**Figure 13.50** ▲ A circuit showing the creation of an impulsive voltage.



**Figure 13.51** ▲ The  $s$ -domain equivalent circuit for the circuit shown in Fig. 13.50.

Solving for  $V_o$  yields

$$V_o = \frac{40(s + 7.5)}{s(s + 5)} + \frac{12(s + 7.5)}{s + 5}. \quad (13.129)$$

We anticipate that  $v_o$  will contain an impulse term because the second term on the right-hand side of Eq. 13.129 is an improper rational function. We can express this improper fraction as a constant plus a rational function by simply dividing the denominator into the numerator; that is,

$$\frac{12(s + 7.5)}{s + 5} = 12 + \frac{30}{s + 5}. \quad (13.130)$$

Combining Eq. 13.130 with the partial fraction expansion of the first term on the right-hand side of Eq. 13.129 gives

$$\begin{aligned} V_o &= \frac{60}{s} - \frac{20}{s + 5} + 12 + \frac{30}{s + 5} \\ &= 12 + \frac{60}{s} + \frac{10}{s + 5}, \end{aligned} \quad (13.131)$$

from which

$$v_o = 12\delta(t) + (60 + 10e^{-5t})u(t) \text{ V}. \quad (13.132)$$

Does this solution make sense? Before answering that question, let's first derive the expression for the current when  $t > 0^-$ . After the switch has been opened, the current in  $L_1$  is the same as the current in  $L_2$ . If we reference the current clockwise around the mesh, the  $s$ -domain expression is

$$\begin{aligned} I &= \frac{(100/s) + 30}{5s + 25} = \frac{20}{s(s + 5)} + \frac{6}{s + 5} \\ &= \frac{4}{s} - \frac{4}{s + 5} + \frac{6}{s + 5} \\ &= \frac{4}{s} + \frac{2}{s + 5}. \end{aligned} \quad (13.133)$$

Inverse-transforming Eq. 13.133 gives

$$i = (4 + 2e^{-5t})u(t) \text{ A}. \quad (13.134)$$

Before the switch is opened, the current in  $L_1$  is 10 A, and the current in  $L_2$  is 0 A; from Eq. 13.134 we know that at  $t = 0^+$ , the current in  $L_1$  and in  $L_2$  is 6 A. Then, the current in  $L_1$  changes instantaneously from 10 to 6 A, while the current in  $L_2$  changes instantaneously from 0 to 6 A. From this value of 6 A, the current decreases exponentially to a final value of 4 A.



This final value is easily verified from the circuit; that is, it should equal  $100/25$ , or 4 A. Figure 13.52 shows these characteristics of  $i_1$  and  $i_2$ .

How can we verify that these instantaneous jumps in the inductor current make sense in terms of the physical behavior of the circuit? First, we note that the switching operation places the two inductors in series. Any impulsive voltage appearing across the 3 H inductor must be exactly balanced by an impulsive voltage across the 2 H inductor, because the sum of the impulsive voltages around a closed path must equal zero. Faraday's law states that the induced voltage is proportional to the change in flux linkage ( $v = d\lambda/dt$ ). Therefore, the change in flux linkage must sum to zero. In other words, the total flux linkage immediately after switching is the same as that before switching. For the circuit here, the flux linkage before switching is

$$\lambda = L_1 i_1 + L_2 i_2 = 3(10) + 2(0) = 30 \text{ Wb-turns.} \quad (13.135)$$

Immediately after switching, it is

$$\lambda = (L_1 + L_2)i(0^+) = 5i(0^+). \quad (13.136)$$

Combining Eqs. 13.135 and 13.136 gives

$$i(0^+) = 30/5 = 6 \text{ A.} \quad (13.137)$$

Thus the solution for  $i$  (Eq. [13.134]) agrees with the principle of the conservation of flux linkage.

We now test the validity of Eq. 13.132. First we check the impulsive term  $12\delta(t)$ . The instantaneous jump of  $i_2$  from 0 to 6 A at  $t = 0$  gives rise to an impulse of strength  $6\delta(t)$  in the derivative of  $i_2$ . This impulse gives rise to the  $12\delta(t)$  in the voltage across the 2 H inductor. For  $t > 0^+$ ,  $di_2/dt$  is  $-10e^{-5t}$  A/s; therefore, the voltage  $v_o$  is

$$\begin{aligned} v_o &= 15(4 + 2e^{-5t}) + 2(-10e^{-5t}) \\ &= (60 + 10e^{-5t})u(t) \text{ V.} \end{aligned} \quad (13.138)$$

Equation 13.138 agrees with the last two terms on the right-hand side of Eq. 13.132; thus we have confirmed that Eq. 13.132 does make sense in terms of known circuit behavior.

We can also check the instantaneous drop from 10 to 6 A in the current  $i_1$ . This drop gives rise to an impulse of  $-4\delta(t)$  in the derivative of  $i_1$ . Therefore the voltage across  $L_1$  contains an impulse of  $-12\delta(t)$  at the origin. This impulse exactly balances the impulse across  $L_2$ ; that is, the sum of the impulsive voltages around a closed path equals zero.

## Impulsive Sources

Impulse functions can occur in sources as well as responses; such sources are called **impulsive sources**. An impulsive source driving a circuit imparts a finite amount of energy into the system instantaneously. A mechanical analogy is striking a bell with an impulsive clapper blow. After the energy has been transferred to the bell, the natural response of the bell determines the tone emitted (that is, the frequency of the resulting sound waves) and the tone's duration.

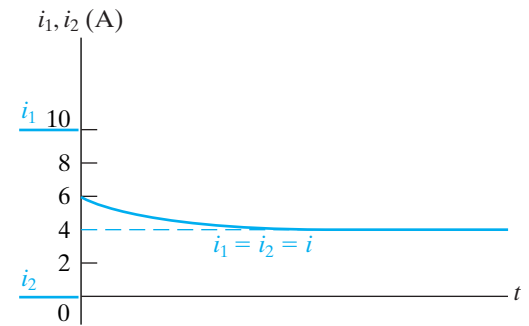
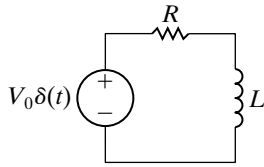


Figure 13.52 ▲ The inductor currents versus  $t$  for the circuit shown in Fig. 13.50.



**Figure 13.53** ▲ An  $RL$  circuit excited by an impulsive voltage source.

In the circuit shown in Fig. 13.53, an impulsive voltage source having a strength of  $V_0$  volt-seconds is applied to a series connection of a resistor and an inductor. When the voltage source is applied, the initial energy in the inductor is zero; therefore the initial current is zero. There is no voltage drop across  $R$ , so the impulsive voltage source appears directly across  $L$ . An impulsive voltage at the terminals of an inductor establishes an instantaneous current. The current is

$$i = \frac{1}{L} \int_0^t V_0 \delta(x) dx. \quad (13.139)$$

Given that the integral of  $\delta(t)$  over any interval that includes zero is 1, we find that Eq. 13.139 yields

$$i(0^+) = \frac{V_0}{L} \text{ A.} \quad (13.140)$$

Thus, in an infinitesimal moment, the impulsive voltage source has stored in the inductor.

$$w = \frac{1}{2} L \left( \frac{V_0}{L} \right)^2 = \frac{1}{2} \frac{V_0^2}{L} \text{ J} \quad (13.141)$$

The current  $V_0/L$  now decays to zero in accordance with the natural response of the circuit; that is,

$$i = \frac{V_0}{L} e^{-t/\tau} u(t), \quad (13.142)$$

where  $\tau = L/R$ . Remember from Chapter 7 that the natural response is attributable only to passive elements releasing or storing energy, and not to the effects of sources. When a circuit is driven by only an impulsive source, the total response is completely defined by the natural response; the duration of the impulsive source is so infinitesimal that it does not contribute to any forced response.

We may also obtain Eq. 13.142 by direct application of the Laplace transform method. Figure 13.54 shows the  $s$ -domain equivalent of the circuit in Fig. 13.53.

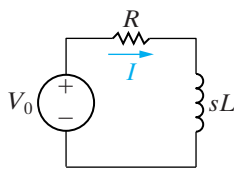
Hence

$$I = \frac{V_0}{R + sL} = \frac{V_0/L}{s + (R/L)}, \quad (13.143)$$

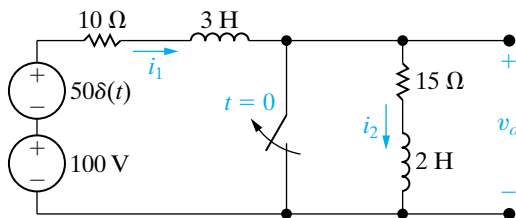
$$i = \frac{V_0}{L} e^{-(R/L)t} = \frac{V_0}{L} e^{-t/\tau} u(t). \quad (13.144)$$

Thus the Laplace transform method gives the correct solution for  $i \geq 0^+$ .

Finally, we consider the case in which internally generated impulses and externally applied impulses occur simultaneously. The Laplace transform approach automatically ensures the correct solution for  $t > 0^+$  if inductor currents and capacitor voltages at  $t = 0^-$  are used in constructing the  $s$ -domain equivalent circuit and if externally applied impulses are represented by their transforms. To illustrate, we add an impulsive voltage



**Figure 13.54** ▲ The  $s$ -domain equivalent circuit for the circuit shown in Fig. 13.53.



**Figure 13.55** ▲ The circuit shown in Fig. 13.50 with an impulsive voltage source added in series with the 100 V source.

source of  $50\delta(t)$  in series with the 100 V source to the circuit shown in Fig. 13.50. Figure 13.55 shows the new arrangement.

At  $t = 0^-$ ,  $i_1(0^-) = 10$  A and  $i_2(0^-) = 0$  A. The Laplace transform of  $50\delta(t) = 50$ . If we use these values, the  $s$ -domain equivalent circuit is as shown in Fig. 13.56.

The expression for  $I$  is

$$\begin{aligned} I &= \frac{50 + (100/s) + 30}{25 + 5s} \\ &= \frac{16}{s + 5} + \frac{20}{s(s + 5)} \\ &= \frac{16}{s + 5} + \frac{4}{s} - \frac{4}{s + 5} \\ &= \frac{12}{s + 5} + \frac{4}{s}, \end{aligned} \quad (13.145)$$

from which

$$i(t) = (12e^{-5t} + 4)u(t) \text{ A.} \quad (13.146)$$

The expression for  $V_o$  is

$$\begin{aligned} V_o &= (15 + 2s)I = \frac{32(s + 7.5)}{s + 5} + \frac{40(s + 7.5)}{s(s + 5)} \\ &= 32\left(1 + \frac{2.5}{s + 5}\right) + \frac{60}{s} - \frac{20}{s + 5} \\ &= 32 + \frac{60}{s + 5} + \frac{60}{s}, \end{aligned} \quad (13.147)$$

from which

$$v_o = 32\delta(t) + (60e^{-5t} + 60)u(t) \text{ V.} \quad (13.148)$$

Now we test the results to see whether they make sense. From Eq. 13.146, we see that the current in  $L_1$  and  $L_2$  is 16 A at  $t = 0^+$ . As in the previous case, the switch operation causes  $i_1$  to decrease instantaneously from 10 to 6 A and, at the same time, causes  $i_2$  to increase from 0 to 6 A. Superimposed on these changes is the establishment of 10 A in  $L_1$  and  $L_2$  by the impulsive voltage source; that is,

$$i = \frac{1}{3 + 2} \int_{0^-}^t 50\delta(x) dx = 10 \text{ A.} \quad (13.149)$$

Therefore  $i_1$  increases suddenly from 10 to 16 A, while  $i_2$  increases suddenly from 0 to 16 A. The final value of  $i$  is 4 A. Figure 13.57 shows  $i_1$ ,  $i_2$ , and  $i$  graphically.

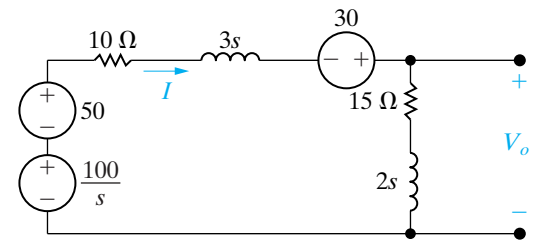


Figure 13.56 ▲ The  $s$ -domain equivalent circuit for the circuit shown in Fig. 13.55.

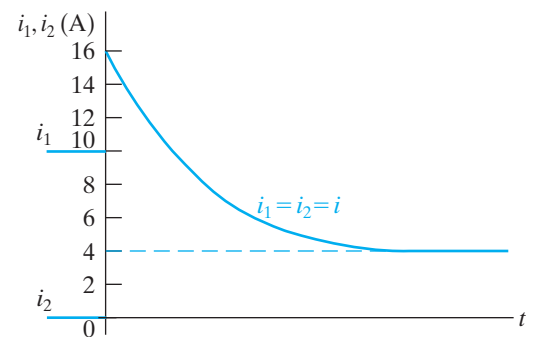


Figure 13.57 ▲ The inductor currents versus  $t$  for the circuit shown in Fig. 13.55.

We may also find the abrupt changes in  $i_1$  and  $i_2$  without using superposition. The sum of the impulsive voltages across  $L_1$  (3 H) and  $L_2$  (2 H) equals  $50\delta(t)$ . Thus the change in flux linkage must sum to 50; that is,

$$\Delta\lambda_1 + \Delta\lambda_2 = 50. \quad (13.150)$$

Because  $\lambda = Li$ , we express Eq. 13.150 as

$$3\Delta i_1 + 2\Delta i_2 = 50. \quad (13.151)$$

But because  $i_1$  and  $i_2$  must be equal after the switching takes place,

$$i_1(0^-) + \Delta i_1 = i_2(0^-) + \Delta i_2. \quad (13.152)$$

Then,

$$10 + \Delta i_1 = 0 + \Delta i_2. \quad (13.153)$$

Solving Eqs. 13.151 and 13.153 for  $\Delta i_1$  and  $\Delta i_2$  yields

$$\Delta i_1 = 6 \text{ A}, \quad (13.154)$$

$$\Delta i_2 = 16 \text{ A}. \quad (13.155)$$

These expressions agree with the previous check.

Figure 13.57 also indicates that the derivatives of  $i_1$  and  $i_2$  will contain an impulse at  $t = 0$ . Specifically, the derivative of  $i_1$  will have an impulse of  $6\delta(t)$ , and the derivative of  $i_2$  will have an impulse of  $16\delta(t)$ . Figure 13.58(a), (b), respectively, illustrate the derivatives of  $i_1$  and  $i_2$ .

Now let's turn to Eq. 13.148. The impulsive component  $32\delta(t)$  agrees with the impulse  $16\delta(t)$  that characterizes  $di_2/dt$  at the origin. The term  $(60e^{-5t} + 60)$  agrees with the fact that for  $t > 0^+$ ,

$$v_o = 15i + 2\frac{di}{dt}.$$

We test the impulsive component of  $di_1/dt$  by noting that it produces an impulsive voltage of  $(3)6\delta(t)$ , or  $18\delta(t)$ , across  $L_1$ . This voltage, along with  $32\delta(t)$  across  $L_2$ , adds to  $50\delta(t)$ . Thus the algebraic sum of the impulsive voltages around the mesh adds to zero.

To summarize, the Laplace transform will correctly predict the creation of impulsive currents and voltages that arise from switching. However, the  $s$ -domain equivalent circuits must be based on initial conditions at  $t = 0^-$ , that is, on the initial conditions that exist prior to the disturbance caused by the switching. The Laplace transform will correctly predict the response to impulsive driving sources by simply representing these sources in the  $s$  domain by their correct transforms.

*NOTE: Assess your understanding of the impulse function in circuit analysis by trying Chapter Problems 13.88 and 13.90.*

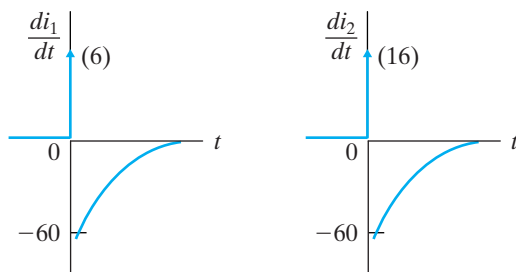


Figure 13.58 ▲ The derivative of  $i_1$  and  $i_2$ .

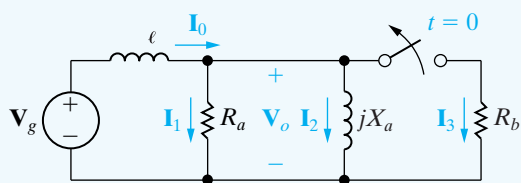
## Practical Perspective

### Surge Suppressors

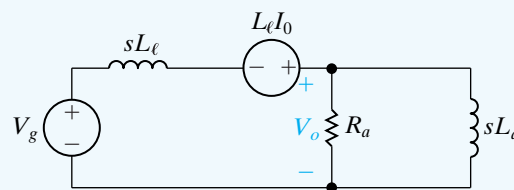
As mentioned at the beginning of this chapter, voltage surges can occur in a circuit that is operating in the sinusoidal steady state. Our purpose is to show how the Laplace transform is used to determine the creation of a surge in voltage between the line and neutral conductors of a household circuit when a load is switched off during sinusoidal steady-state operation.

Consider the circuit shown in Fig. 13.59, which models a household circuit with three loads, one of which is switched off at time  $t = 0$ . To simplify the analysis, we assume that the line-to-neutral voltage,  $\mathbf{V}_o$ , is  $120 \angle 0^\circ$  V (rms), a standard household voltage, and that when the load is switched off at  $t = 0$ , the value of  $\mathbf{V}_g$  does not change. After the switch is opened, we can construct the  $s$ -domain circuit, as shown in Fig. 13.60. Note that because the phase angle of the voltage across the inductive load is  $0^\circ$ , the initial current through the inductive load is 0. Therefore, only the inductance in the line has a non-zero initial condition, which is modeled in the  $s$ -domain circuit as a voltage source with the value  $L_\ell I_0$ , as seen in Fig. 13.60.

Just before the switch is opened at  $t = 0$ , each of the loads has a steady-state sinusoidal voltage with a peak magnitude of  $120\sqrt{2} = 169.7$  V. All of the current flowing through the line from the voltage source  $y_g$  is divided among the three loads. When the switch is opened at  $t = 0$ , all of the current in the line will flow through the remaining resistive load. This is because the current in the inductive load is 0 at  $t = 0$  and the current in an inductor cannot change instantaneously. Therefore, the voltage drop across the remaining loads can experience a surge as the line current is directed through the resistive load. For example, if the initial current in the line is 25 A (rms) and the impedance of the resistive load is  $12 \Omega$ , the voltage drop across the resistor surges from 169.7 V to  $(25)(\sqrt{2})(12) = 424.3$  V when the switch is opened. If the resistive load cannot handle this amount of voltage, it needs to be protected with a surge suppressor such as those shown at the beginning of the chapter.



**Figure 13.59** ▲ Circuit used to introduce a switching surge voltage.



**Figure 13.60** ▲ Symbolic  $s$ -domain circuit.

*NOTE: Assess your understanding of this Practical Perspective by trying Chapter Problems 13.92 and 13.93*

## Summary

- We can represent each of the circuit elements as an  $s$ -domain equivalent circuit by Laplace-transforming the voltage-current equation for each element:

- Resistor:  $V = RI$

- Inductor:  $V = sLI - LI_0$

- Capacitor:  $V = (1/sC)I + V_0/s$

In these equations,  $V = \mathcal{L}\{v\}$ ,  $I = \mathcal{L}\{i\}$ ,  $I_0$  is the initial current through the inductor, and  $V_0$  is the initial voltage across the capacitor. (See pages 466–467.)

- We can perform circuit analysis in the  $s$  domain by replacing each circuit element with its  $s$ -domain equivalent circuit. The resulting equivalent circuit is solved by writing algebraic equations using the circuit analysis techniques from resistive circuits. Table 13.1 summarizes the equivalent circuits for resistors, inductors, and capacitors in the  $s$  domain. (See page 468.)
- Circuit analysis in the  $s$  domain is particularly advantageous for solving transient response problems in linear lumped parameter circuits when initial conditions are known. It is also useful for problems involving multiple simultaneous mesh-current or node-voltage equations, because it reduces problems to algebraic rather than differential equations. (See pages 474–476.)
- The **transfer function** is the  $s$ -domain ratio of a circuit's output to its input. It is represented as

$$H(s) = \frac{Y(s)}{X(s)},$$

where  $Y(s)$  is the Laplace transform of the output signal, and  $X(s)$  is the Laplace transform of the input signal. (See page 482.)

- The partial fraction expansion of the product  $H(s)X(s)$  yields a term for each pole of  $H(s)$  and  $X(s)$ . The  $H(s)$  terms correspond to the transient component of the total response; the  $X(s)$  terms correspond to the steady-state component. (See page 484.)
- If a circuit is driven by a unit impulse,  $x(t) = \delta(t)$ , then the response of the circuit equals the inverse Laplace transform of the transfer function,  $y(t) = \mathcal{L}^{-1}\{H(s)\} = h(t)$ . (See pages 486–487.)

- A **time-invariant** circuit is one for which, if the input is delayed by  $a$  seconds, the response function is also delayed by  $a$  seconds. (See page 486.)

- The output of a circuit,  $y(t)$ , can be computed by convolving the input,  $x(t)$ , with the impulse response of the circuit,  $h(t)$ :

$$y(t) = h(t) * x(t) = \int_0^t h(\lambda)x(t - \lambda)d\lambda$$

$$= x(t) * h(t) = \int_0^t x(\lambda)h(t - \lambda)d\lambda.$$

A graphical interpretation of the convolution integral often provides an easier computational method to generate  $y(t)$ . (See page 487.)

- We can use the transfer function of a circuit to compute its steady-state response to a sinusoidal source. To do so, make the substitution  $s = j\omega$  in  $H(s)$  and represent the resulting complex number as a magnitude and phase angle. If

$$x(t) = A \cos(\omega t + \phi),$$

$$H(j\omega) = |H(j\omega)|e^{j\theta(\omega)},$$

then

$$y_{ss}(t) = A|H(j\omega)| \cos[\omega t + \phi + \theta(\omega)].$$

(See page 494.)

- Laplace transform analysis correctly predicts impulsive currents and voltages arising from switching and impulsive sources. You must ensure that the  $s$ -domain equivalent circuits are based on initial conditions at  $t = 0^-$ , that is, prior to the switching. (See page 496.)

## Problems

### Section 13.1

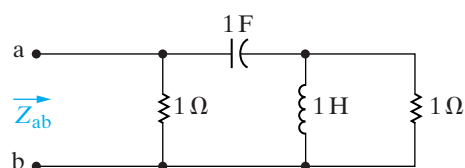
- 13.1** Derive the  $s$ -domain equivalent circuit shown in Fig. 13.4 by expressing the inductor current  $i$  as a function of the terminal voltage  $v$  and then finding the Laplace transform of this time-domain integral equation.
- 13.2** Find the Thévenin equivalent of the circuit shown in Fig. 13.7.
- 13.3** Find the Norton equivalent of the circuit shown in Fig. 13.3.

### Section 13.2

- 13.4** A  $400\ \Omega$  resistor, a  $12.5\ \text{mH}$  inductor, and a  $0.5\ \mu\text{F}$  capacitor are in series.
- Express the  $s$ -domain impedance of this series combination as a rational function.
  - Give the numerical value of the poles and zeros of the impedance.
- 13.5** An  $8\ \text{k}\Omega$  resistor, a  $25\ \text{mH}$  inductor, and a  $62.5\ \text{pF}$  capacitor are in parallel.
- Express the  $s$ -domain impedance of this parallel combination as a rational function.
  - Give the numerical values of the poles and zeros of the impedance.
- 13.6** A  $200\ \Omega$  resistor is in series with a  $62.5\ \mu\text{F}$  capacitor. This series combination is in parallel with a  $400\ \text{mH}$  inductor.
- Express the equivalent  $s$ -domain impedance of these parallel branches as a rational function.
  - Determine the numerical values of the poles and zeros.

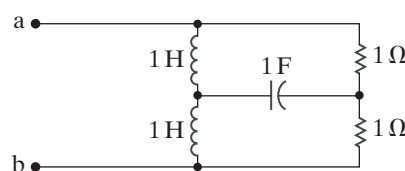
- 13.7** Find the poles and zeros of the impedance seen looking into the terminals a,b of the circuit shown in Fig. P13.7.

Figure P13.7



- 13.8** Find the poles and zeros of the impedance seen looking into the terminals a,b of the circuit shown in Fig. P13.8.

Figure P13.8

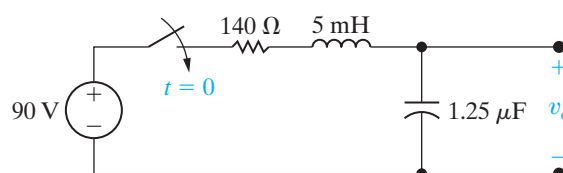


### Section 13.3

- 13.9** Find  $V_o$  and  $v_o$  in the circuit shown in Fig. P13.9 if the initial energy is zero and the switch is closed at  $t = 0$ .

PSPICE  
MULTISIM

Figure P13.9



- 13.10** Repeat Problem 13.9 if the initial voltage on the capacitor is  $150\ \text{V}$  positive at the upper terminal.

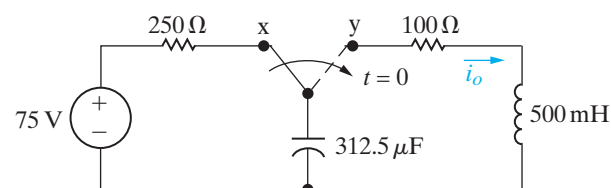
PSPICE  
MULTISIM

- 13.11** The switch in the circuit shown in Fig. P13.11 has been in position x for a long time. At  $t = 0$ , the switch moves instantaneously to position y.

PSPICE  
MULTISIM

- Construct an  $s$ -domain circuit for  $t > 0$ .
- Find  $I_o$ .
- Find  $i_o$ .

Figure P13.11



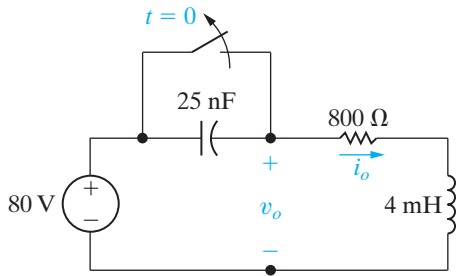
- 13.12** The switch in the circuit in Fig. P13.12 has been closed for a long time. At  $t = 0$ , the switch is opened.

PSPICE  
MULTISIM

- Find  $i_o$  for  $t \geq 0$ .
- Find  $v_o$  for  $t \geq 0$ .



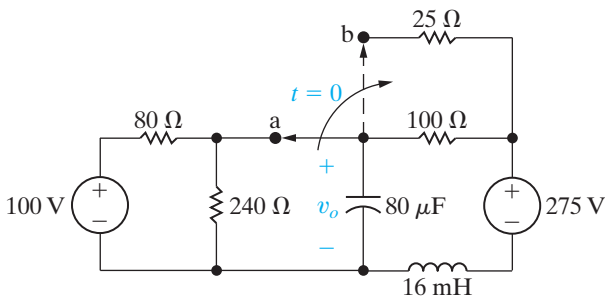
Figure P13.12



**13.13** The switch in the circuit in Fig. P13.13 has been in position a for a long time. At  $t = 0$ , it moves instantaneously from a to b.

- Construct the  $s$ -domain circuit for  $t > 0$ .
- Find  $V_o(s)$ .
- Find  $v_o(t)$  for  $t \geq 0$ .

Figure P13.13

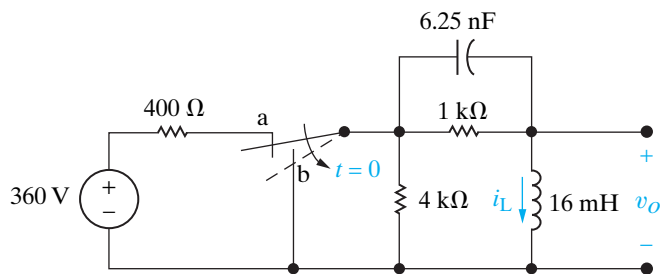


**13.14** The switch in the circuit in Fig. P13.14 has been in position a for a long time. At  $t = 0$ , the switch moves instantaneously to position b.

PSPICE MULTISIM

- Construct the  $s$ -domain circuit for  $t > 0$ .
- Find  $V_o$ .
- Find  $I_L$ .
- Find  $v_o$  for  $t > 0$ .
- Find  $i_L$  for  $t \geq 0$ .

Figure P13.14

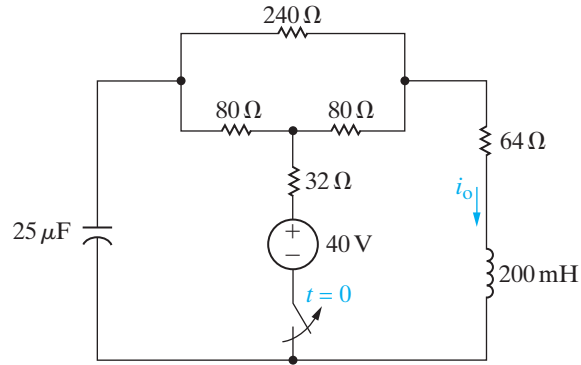


**13.15** The switch in the circuit in Fig. P13.15 has been closed for a long time before opening at  $t = 0$ .

PSPICE MULTISIM

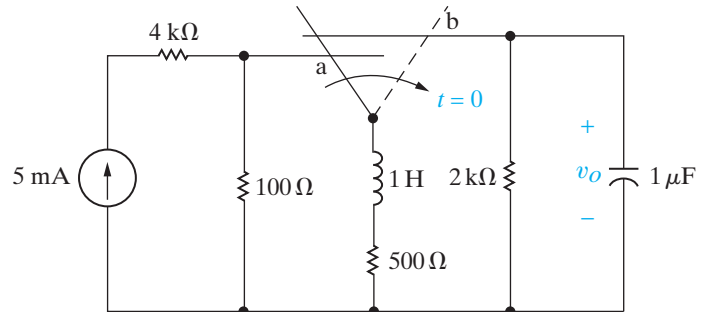
- Construct the  $s$ -domain equivalent circuit for  $t > 0$ .
- Find  $I_o$ .
- Find  $i_o$  for  $t \geq 0$ .

Figure P13.15



**13.16** The make-before-break switch in the circuit in Fig. P13.16 has been in position a for a long time. At  $t = 0$ , it moves instantaneously to position b. Find  $v_o$  for  $t \geq 0$ .

Figure P13.16

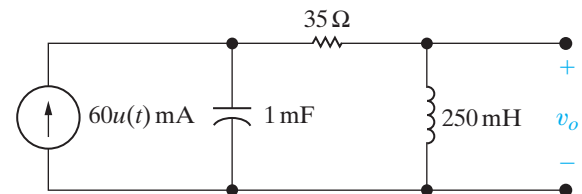


**13.17** a) Find the  $s$ -domain expression for  $V_o$  in the circuit in Fig. P13.17.

PSPICE MULTISIM

- Use the  $s$ -domain expression derived in (a) to predict the initial- and final-values of  $v_o$ .
- Find the time-domain expression for  $v_o$ .

Figure P13.17



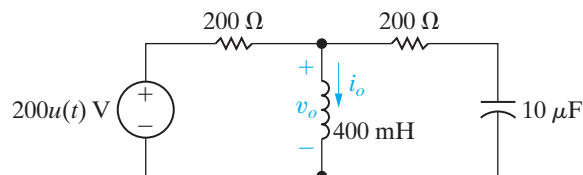
**13.18** Find the time-domain expression for the current in the capacitor in Fig. P13.17. Assume the reference direction for  $i_C$  is down.

**13.19** There is no energy stored in the circuit in Fig. P13.19 at  $t = 0^-$ .

PSPICE MULTISIM

- Use the mesh current method to find  $i_o$ .
- Find the time domain expression for  $v_o$ .
- Do your answers in (a) and (b) make sense in terms of known circuit behavior? Explain.

Figure P13.19

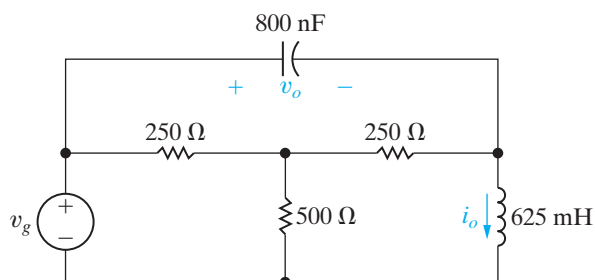


**13.20** There is no energy stored in the circuit in Fig. P13.20 at the time the voltage source is turned on, and  $v_g = 325u(t)$  V.

PSPICE  
MULTISIM

- Find  $V_o$  and  $I_o$ .
- Find  $v_o$  and  $i_o$ .
- Do the solutions for  $v_o$  and  $i_o$  make sense in terms of known circuit behavior? Explain.

Figure P13.20

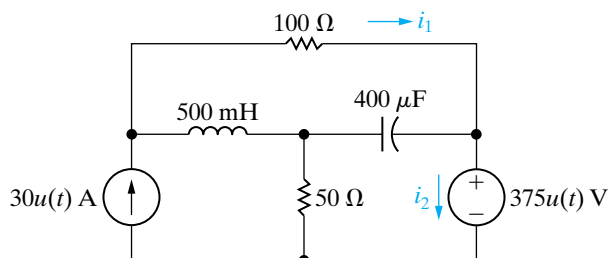


**13.21** There is no energy stored in the circuit in Fig. P13.21 at the time the sources are energized.

PSPICE  
MULTISIM

- Find  $I_1(s)$  and  $I_2(s)$ .
- Use the initial- and final-value theorems to check the initial- and final-values of  $i_1(t)$  and  $i_2(t)$ .
- Find  $i_1(t)$  and  $i_2(t)$  for  $t \geq 0$ .

Figure P13.21

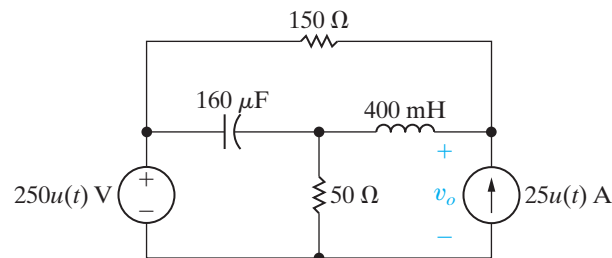


**13.22** There is no energy stored in the circuit in Fig. P13.22 at  $t = 0^-$ .

PSPICE  
MULTISIM

- Find  $V_o$ .
- Find  $v_o$ .
- Does your solution for  $v_o$  make sense in terms of known circuit behavior? Explain.

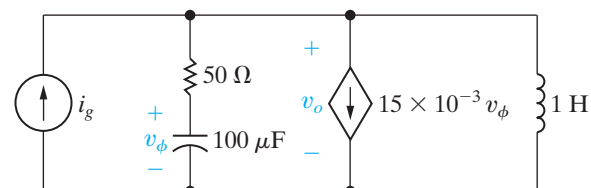
Figure P13.22



**13.23** Find  $v_o$  in the circuit shown in Fig. P13.23 if  $i_g = 20u(t)$  mA. There is no energy stored in the circuit at  $t = 0$ .

PSPICE  
MULTISIM

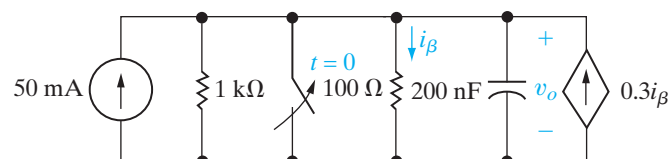
Figure P13.23



**13.24** The switch in the circuit in Fig. P13.24 has been closed for a long time before opening at  $t = 0$ . Find  $v_o$  for  $t \geq 0$ .

PSPICE  
MULTISIM

Figure P13.24

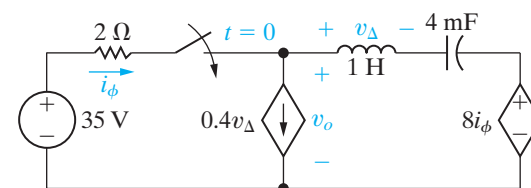


**13.25** There is no energy stored in the circuit in Fig. P13.25 at the time the switch is closed.

PSPICE  
MULTISIM

- Find  $v_o$  for  $t \geq 0$ .
- Does your solution make sense in terms of known circuit behavior? Explain.

Figure P13.25



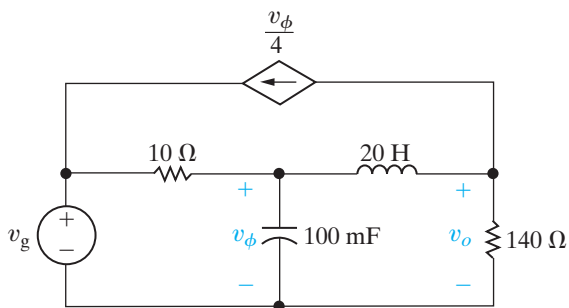
**13.26** The initial energy in the circuit in Fig. P13.26 is zero. The ideal voltage source is  $600u(t)$  V.

PSPICE  
MULTISIM

- Find  $V_o(s)$ .
- Use the initial- and final-value theorems to find  $v_o(0^+)$  and  $v_o(\infty)$ .

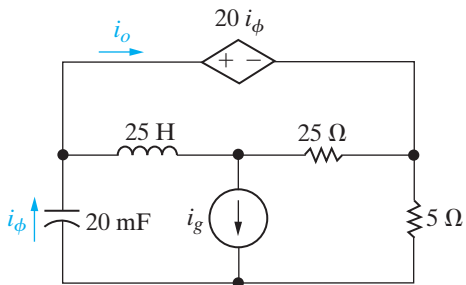
- c) Do the values obtained in (b) agree with known circuit behavior? Explain.
- d) Find  $v_o(t)$ .

Figure P13.26



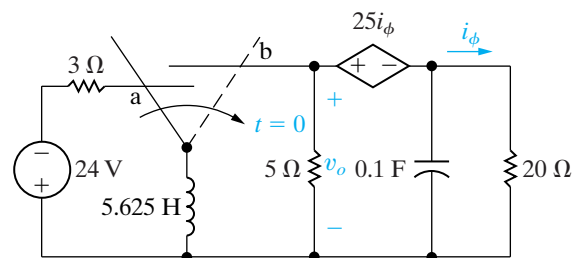
- 13.27** There is no energy stored in the circuit in Fig. P13.27 at the time the current source turns on. Given that  $i_g = 100u(t)$  A:
- a) Find  $I_o(s)$ .
  - b) Use the initial- and final-value theorems to find  $i_o(0^+)$  and  $i_o(\infty)$ .
  - c) Determine if the results obtained in (b) agree with known circuit behavior.
  - d) Find  $i_o(t)$ .

Figure P13.27



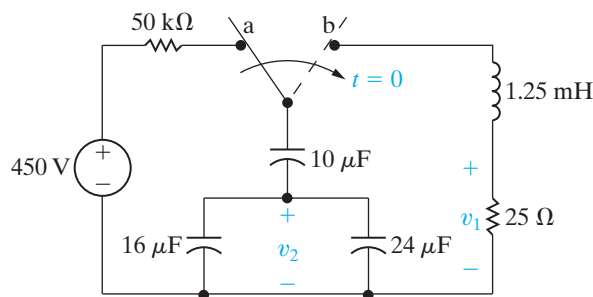
- 13.28** The switch in the circuit seen in Fig. P13.28 has been in position a for a long time. At  $t = 0$ , it moves instantaneously to position b.
- a) Find  $V_o$ .
  - b) Find  $v_o$ .

Figure P13.28



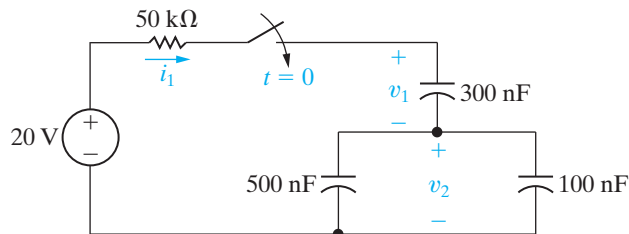
- 13.29** The switch in the circuit seen in Fig. P13.29 has been in position a for a long time before moving instantaneously to position b at  $t = 0$ .
- a) Construct the  $s$ -domain equivalent circuit for  $t > 0$ .
  - b) Find  $V_1$  and  $v_1$ .
  - c) Find  $V_2$  and  $v_2$ .

Figure P13.29



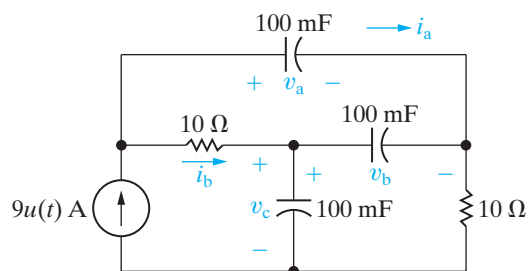
- 13.30** There is no energy stored in the capacitors in the circuit in Fig. P13.30 at the time the switch is closed.
- a) Construct the  $s$ -domain circuit for  $t > 0$ .
  - b) Find  $I_1$ ,  $V_1$ , and  $V_2$ .
  - c) Find  $i_1$ ,  $v_1$ , and  $v_2$ .
  - d) Do your answers for  $i_1$ ,  $v_1$ , and  $v_2$  make sense in terms of known circuit behavior? Explain.

Figure P13.30



- 13.31** There is no energy stored in the circuit in Fig. P13.31 at the time the current source is energized.
- a) Find  $I_a$  and  $I_b$ .
  - b) Find  $i_a$  and  $i_b$ .
  - c) Find  $V_a$ ,  $V_b$ , and  $V_c$ .
  - d) Find  $v_a$ ,  $v_b$ , and  $v_c$ .
  - e) Assume a capacitor will break down whenever its terminal voltage is 1000 V. How long after the current source turns on will one of the capacitors break down?

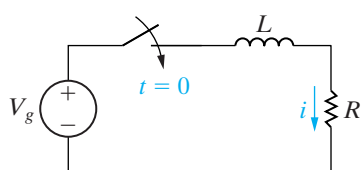
Figure P13.31



**13.32** The switch in the circuit shown in Fig. P13.32 has been open for a long time. The voltage of the sinusoidal source is  $v_g = V_m \sin(\omega t + \phi)$ . The switch closes at  $t = 0$ . Note that the angle  $\phi$  in the voltage expression determines the value of the voltage at the moment when the switch closes, that is,  $v_g(0) = V_m \sin \phi$ .

- Use the Laplace transform method to find  $i$  for  $t > 0$ .
- Using the expression derived in (a), write the expression for the current after the switch has been closed for a long time.
- Using the expression derived in (a), write the expression for the transient component of  $i$ .
- Find the steady-state expression for  $i$  using the phasor method. Verify that your expression is equivalent to that obtained in (b).
- Specify the value of  $\phi$  so that the circuit passes directly into steady-state operation when the switch is closed.

Figure P13.32



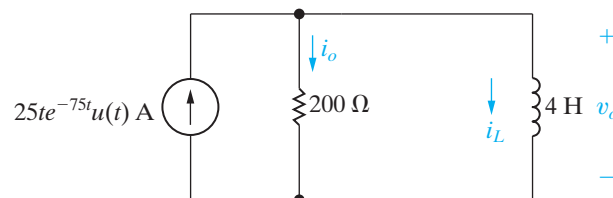
**13.33** Beginning with Eq. 13.65, show that the capacitor current in the circuit in Fig. 13.19 is positive for  $0 < t < 200 \mu\text{s}$  and negative for  $t > 200 \mu\text{s}$ . Also show that at  $200 \mu\text{s}$ , the current is zero and that this corresponds to when  $dv_C/dt$  is zero.

**13.34** There is no energy stored in the circuit in Fig. P13.34 at the time the voltage source is energized.

PSPICE  
MULTISIM

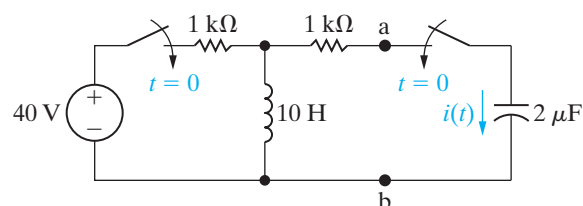
- Find  $V_o$ ,  $I_o$ , and  $I_L$ .
- Find  $v_o$ ,  $i_o$ , and  $i_L$  for  $t \geq 0$ .

Figure P13.34



**13.35** The two switches in the circuit shown in Fig. P13.35 operate simultaneously. There is no energy stored in the circuit at the instant the switches close. Find  $i(t)$  for  $t \geq 0^+$  by first finding the  $s$ -domain Thévenin equivalent of the circuit to the left of the terminals a, b.

Figure P13.35

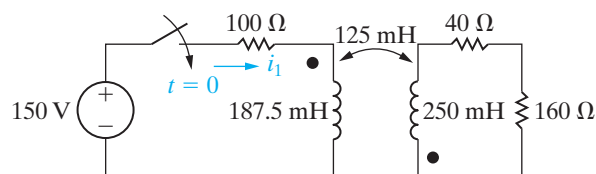


**13.36** There is no energy stored in the circuit in Fig. P13.36 at the time the switch is closed.

PSPICE  
MULTISIM

- Find  $I_1$ .
- Use the initial- and final-value theorems to find  $i_1(0^+)$  and  $i_1(\infty)$ .
- Find  $i_1$ .

Figure P13.36



**13.37** a) Find the current in the  $160 \Omega$  resistor in the circuit in Fig. P13.36. The reference direction for the current is down through the resistor.

PSPICE  
MULTISIM

- Repeat part (a) if the dot on the  $250 \text{ mH}$  coil is reversed.

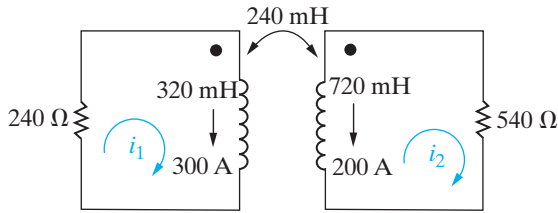
**13.38** The magnetically coupled coils in the circuit seen in Fig. P13.38 carry initial currents of  $300$  and  $200 \text{ A}$ , as shown.

PSPICE  
MULTISIM

- Find the initial energy stored in the circuit.
- Find  $I_1$  and  $I_2$ .

- c) Find  $i_1$  and  $i_2$ .
- d) Find the total energy dissipated in the 240 and 540  $\Omega$  resistors.
- e) Repeat (a)–(d), with the dot on the 720 mH inductor at the lower terminal.

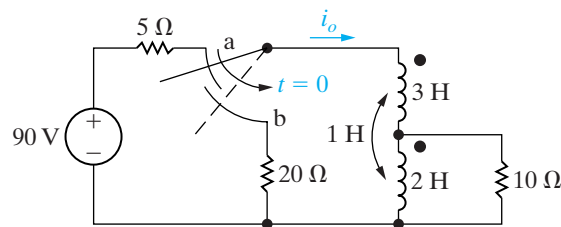
Figure P13.38



- 13.39** The make-before-break switch in the circuit seen in Fig. P13.39 has been in position a for a long time. At  $t = 0$ , it moves instantaneously to position b. Find  $i_o$  for  $t \geq 0$ .

PSPICE  
MULTISIM

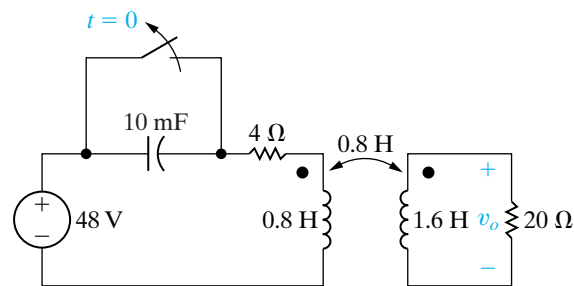
Figure P13.39



- 13.40** The switch in the circuit seen in Fig. P13.40 has been closed for a long time before opening at  $t = 0$ . Use the Laplace transform method of analysis to find  $v_o$ .

PSPICE  
MULTISIM

Figure P13.40



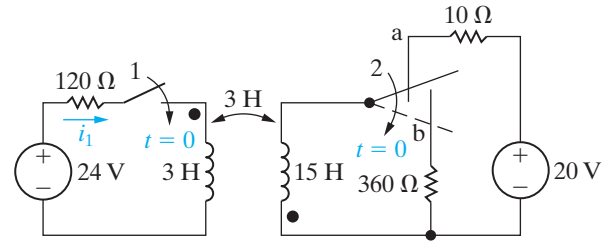
- 13.41** In the circuit in Fig. P13.41, switch 1 closes at  $t = 0$ , and the make-before-break switch moves instantaneously from position a to position b.

PSPICE  
MULTISIM

- a) Construct the  $s$ -domain equivalent circuit for  $t > 0$ .
- b) Find  $I_1$ .

- c) Use the initial- and final-value theorems to check the initial and final values of  $i_1$ .
- d) Find  $i_1$  for  $t \geq 0^+$ .

Figure P13.41



- 13.42** Verify that the solution of Eqs. 13.91 and 13.92 for  $V_2$  yields the same expression as that given by Eq. 13.90.

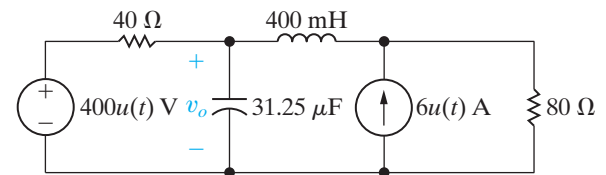
PSPICE  
MULTISIM

- 13.43** There is no energy stored in the circuit seen in Fig. P13.43 at the time the two sources are energized.

PSPICE  
MULTISIM

- a) Use the principle of superposition to find  $V_o$ .
- b) Find  $v_o$  for  $t > 0$ .

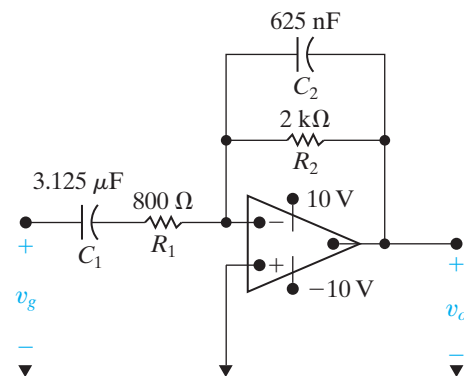
Figure P13.43



- 13.44** The op amp in the circuit shown in Fig. P13.44 is ideal. There is no energy stored in the circuit at the time it is energized. If  $v_g = 5000tu(t)$  V, find (a)  $V_o$ , (b)  $v_o$ , (c) how long it takes to saturate the operational amplifier, and (d) how small the rate of increase in  $v_g$  must be to prevent saturation.

PSPICE  
MULTISIM

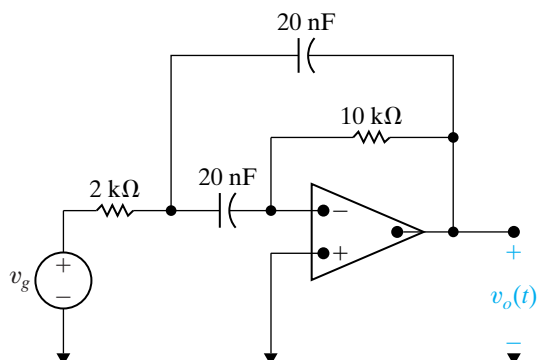
Figure P13.44



**13.45** Find  $v_o(t)$  in the circuit shown in Fig. P13.45 if the ideal op amp operates within its linear range and  $v_g = 16u(t)$  mV.

PSPICE  
MULTISIM

Figure P13.45

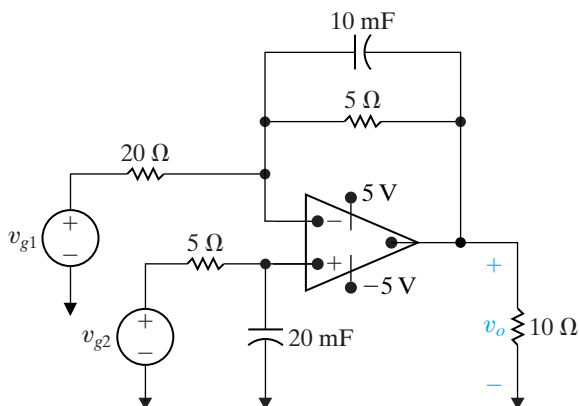


**13.46** The op amp in the circuit shown in Fig. P13.46 is ideal. There is no energy stored in the capacitors at the instant the circuit is energized.

PSPICE  
MULTISIM

- Find  $v_o$  if  $v_{g1} = 40u(t)$  V and  $v_{g2} = 16u(t)$  V.
- How many milliseconds after the two voltage sources are turned on does the op amp saturate?

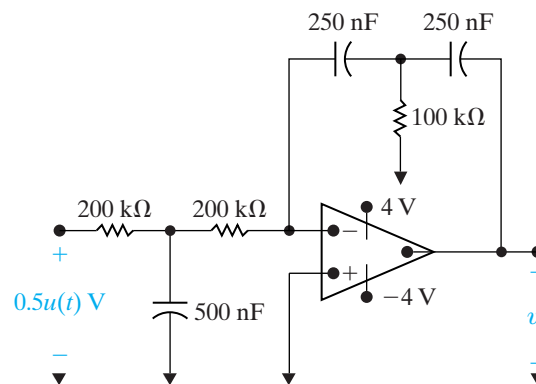
Figure P13.46



**13.47** The op amp in the circuit seen in Fig. P13.47 is ideal. There is no energy stored in the capacitors at the time the circuit is energized. Determine (a)  $V_o$ , (b)  $v_o$ , and (c) how long it takes to saturate the operational amplifier.

PSPICE  
MULTISIM

Figure P13.47



Sections 13.4–13.5

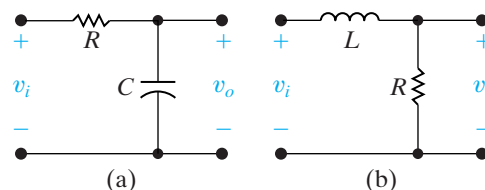
**13.48** a) Find the transfer function  $H(s) = V_o/V_i$  for the circuit shown in Fig. P13.48(a).

PSPICE  
MULTISIM

b) Find the transfer function  $H(s) = V_o/V_i$  for the circuit shown in Fig. P13.48(b).

c) Create two different circuits that have the transfer function  $H(s) = V_o/V_i = 1000/(s+1000)$ . Use components selected from Appendix H and Figs. P13.48(a) and (b).

Figure P13.48

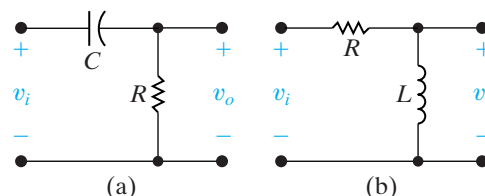


**13.49** a) Find the transfer function  $H(s) = V_o/V_i$  for the circuit shown in Fig. P13.49(a).

b) Find the transfer function  $H(s) = V_o/V_i$  for the circuit shown in Fig. P13.49(b).

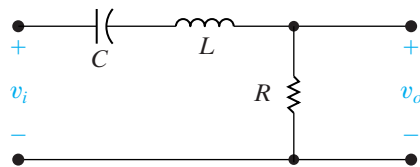
c) Create two different circuits that have the transfer function  $H(s) = V_o/V_i = s/(s + 10,000)$ . Use components selected from Appendix H and Figs. P13.49(a) and (b).

Figure P13.49



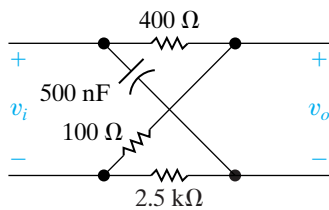
- 13.50** a) Find the transfer function  $H(s) = V_o/V_i$  for the circuit shown in Fig. P13.50. Identify the poles and zeros for this transfer function.
- b) Find three components from Appendix H which when used in the circuit of Fig. P13.50 will result in a transfer function with two poles that are distinct real numbers. Calculate the values of the poles.
- c) Find three components from Appendix H which when used in the circuit of Fig. P13.50 will result in a transfer function with two poles, both with the same value. Calculate the value of the poles.
- d) Find three components from Appendix H which when used in the circuit of Fig. P13.50 will result in a transfer function with two poles that are complex conjugate complex numbers. Calculate the values of the poles.

Figure P13.50



- 13.51** a) Find the numerical expression for the transfer function  $H(s) = V_o/V_i$  for the circuit in Fig. P13.51.
- b) Give the numerical value of each pole and zero of  $H(s)$ .

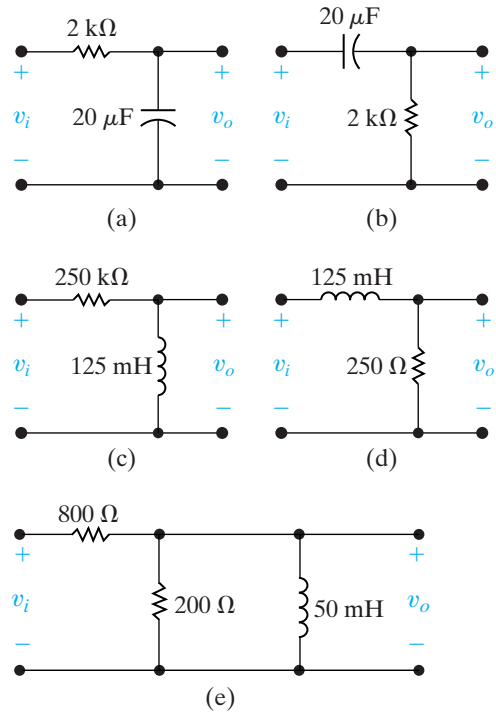
Figure P13.51



- 13.52** Find the numerical expression for the transfer function ( $V_o/V_i$ ) of each circuit in Fig. P13.52 and give the numerical value of the poles and zeros of each transfer function.

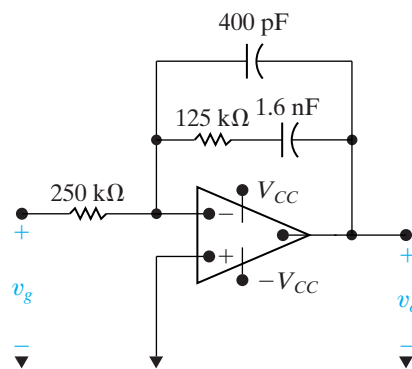
PSPICE  
MULTISIM

Figure P13.52



- 13.53** The operational amplifier in the circuit in Fig. P13.53 is ideal.
- a) Find the numerical expression for the transfer function  $H(s) = V_o/V_g$ .
- b) Give the numerical value of each zero and pole of  $H(s)$ .

Figure P13.53

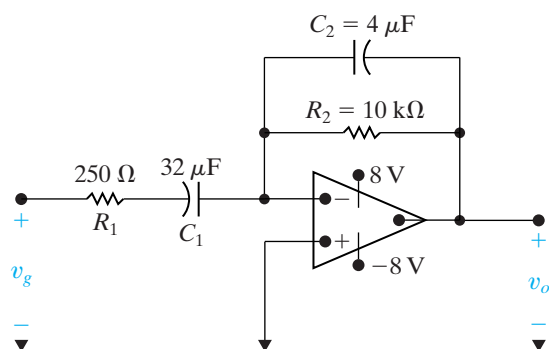




**13.54** The operational amplifier in the circuit in Fig. P13.54 is ideal.

- Find the numerical expression for the transfer function  $H(s) = V_o/V_g$ .
- Give the numerical value of each zero and pole of  $H(s)$ .

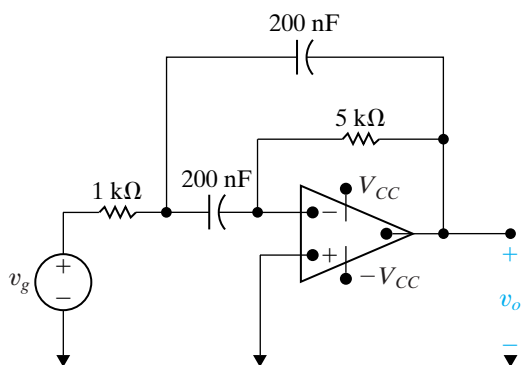
Figure P13.54



**13.55** The operational amplifier in the circuit in Fig. P13.55 is ideal.

- Derive the numerical expression of the transfer function  $H(s) = V_o/V_g$  for the circuit in Fig. P13.55.
- Give the numerical value of each pole and zero of  $H(s)$ .

Figure P13.55



**13.56** There is no energy stored in the circuit in Fig. P13.56 at the time the switch is opened. The sinusoidal current source is generating the signal  $25 \cos 200t$  mA. The response signal is the current  $i_o$ .

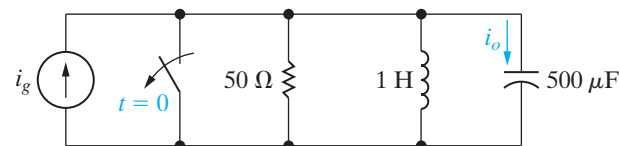
PSPICE  
MULTISIM

- Find the transfer function  $I_o/I_g$ .
- Find  $I_o(s)$ .
- Describe the nature of the transient component of  $i_o(t)$  without solving for  $i_o(t)$ .

d) Describe the nature of the steady-state component of  $i_o(t)$  without solving for  $i_o(t)$ .

e) Verify the observations made in (c) and (d) by finding  $i_o(t)$ .

Figure P13.56



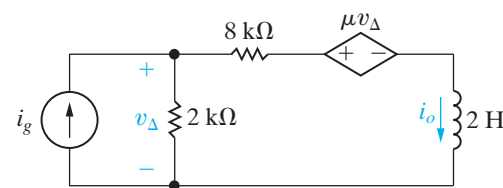
**13.57** a) Find the transfer function  $I_o/I_g$  as a function of  $\mu$  for the circuit seen in Fig. P13.57.

PSPICE  
MULTISIM

b) Find the largest value of  $\mu$  that will produce a bounded output signal for a bounded input signal.

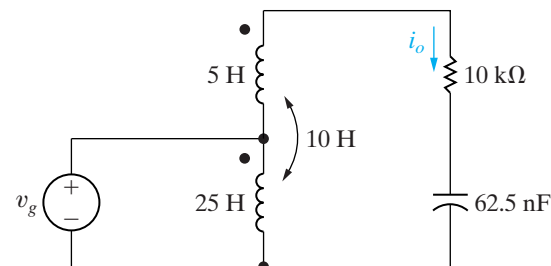
c) Find  $i_o$  for  $\mu = -3, 0, 4, 5,$  and  $6$  if  $i_g = 5u(t)$  A.

Figure P13.57



**13.58** In the circuit of Fig. P13.58  $i_o$  is the output signal and  $v_g$  is the input signal. Find the poles and zeros of the transfer function, assuming there is no initial energy stored in the linear transformer or in the capacitor.

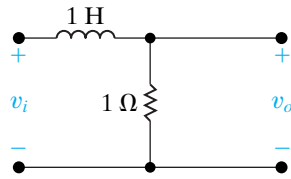
Figure P13.58



### Section 13.6

**13.59** A rectangular voltage pulse  $v_i = [u(t) - u(t - 1)]$  V is applied to the circuit in Fig. P13.59. Use the convolution integral to find  $v_o$ .

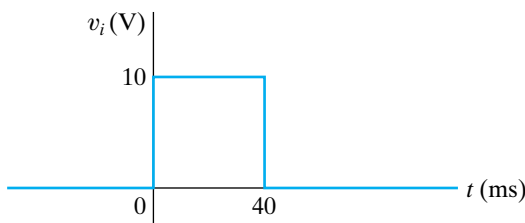
Figure P13.59



**13.60** Interchange the inductor and resistor in Problem 13.59 and again use the convolution integral to find  $v_o$ .

- 13.61** a) Use the convolution integral to find the output voltage of the circuit in Fig. P13.52(a) if the input voltage is the rectangular pulse shown in Fig. P13.61.  
 b) Sketch  $v_o(t)$  versus  $t$  for the time interval  $0 \leq t \leq 100$  ms.

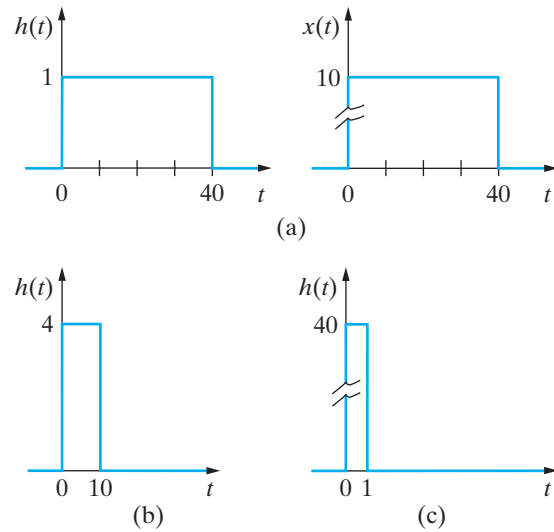
Figure P13.61



- 13.62** a) Repeat Problem 13.61, given that the resistor in the circuit in Fig. P13.52(a) is decreased to  $200 \Omega$ .  
 b) Does decreasing the resistor increase or decrease the memory of the circuit?  
 c) Which circuit comes closer to transmitting a replica of the input voltage?

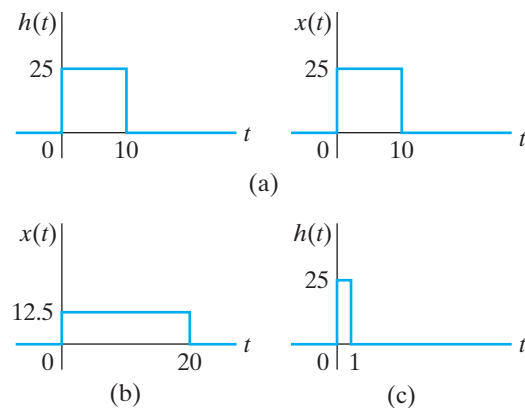
- 13.63** a) Given  $y(t) = h(t) * x(t)$ , find  $y(t)$  when  $h(t)$  and  $x(t)$  are the rectangular pulses shown in Fig. P13.63(a).  
 b) Repeat (a) when  $h(t)$  changes to the rectangular pulse shown in Fig. P13.63(b).  
 c) Repeat (a) when  $h(t)$  changes to the rectangular pulse shown in Fig. P13.63(c).  
 d) Sketch  $y(t)$  versus  $t$  for (a)–(c) on a single graph.  
 e) Do the sketches in (d) make sense? Explain.

Figure P13.63



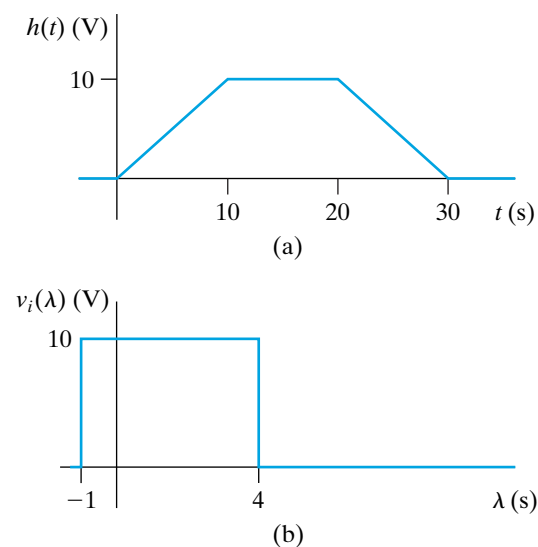
- 13.64** a) Find  $h(t) * x(t)$  when  $h(t)$  and  $x(t)$  are the rectangular pulses shown in Fig. P13.64(a).  
 b) Repeat (a) when  $x(t)$  changes to the rectangular pulse shown in Fig. P13.64(b).  
 c) Repeat (a) when  $h(t)$  changes to the rectangular pulse shown in Fig. P13.64(c).

Figure P13.64



- 13.65** The voltage impulse response of a circuit is shown in Fig. P13.65(a). The input signal to the circuit is the rectangular voltage pulse shown in Fig. P13.65(b).  
 a) Derive the equations for the output voltage. Note the range of time for which each equation is applicable.  
 b) Sketch  $v_o$  for  $-1 \leq t \leq 34$  s.

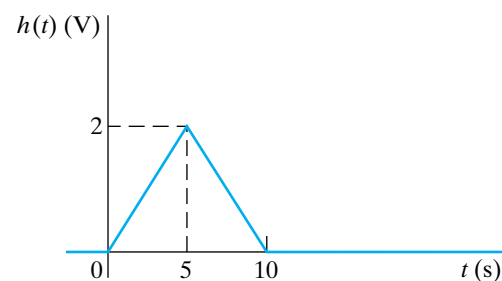
Figure P13.65



**13.66** Assume the voltage impulse response of a circuit can be modeled by the triangular waveform shown in Fig. P13.66. The voltage input signal to this circuit is the step function  $10u(t)$  V.

- Use the convolution integral to derive the expressions for the output voltage.
- Sketch the output voltage over the interval 0 to 15 s.
- Repeat parts (a) and (b) if the area under the voltage impulse response stays the same but the width of the impulse response narrows to 4 s.
- Which output waveform is closer to replicating the input waveform: (b) or (c)? Explain.

Figure P13.66



**13.67** a) Assume the voltage impulse response of a circuit is

$$h(t) = \begin{cases} 0, & t < 0; \\ 10e^{-4t}, & t \geq 0. \end{cases}$$

Use the convolution integral to find the output voltage if the input signal is  $10u(t)$  V.

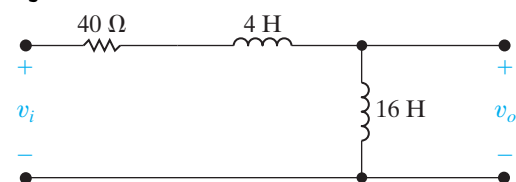
b) Repeat (a) if the voltage impulse response is

$$h(t) = \begin{cases} 0, & t < 0; \\ 10(1 - 2t), & 0 \leq t \leq 0.5; \\ 0, & t \geq 0.5 \text{ s.} \end{cases}$$

c) Plot the output voltage versus time for (a) and (b) for  $0 \leq t \leq 1$  s.

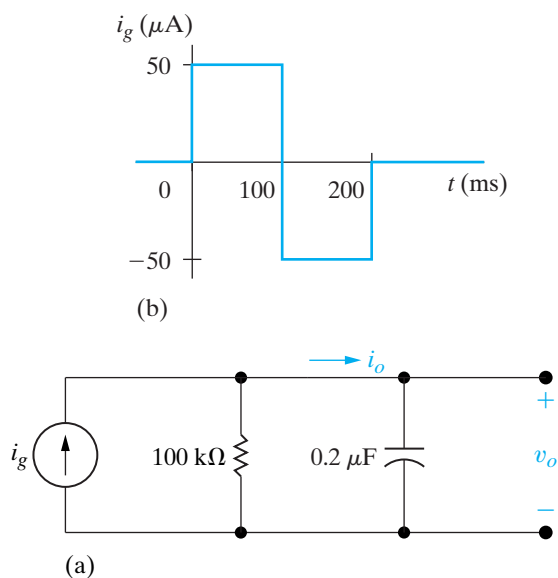
**13.68** Use the convolution integral to find  $v_o$  in the circuit seen in Fig. P13.68 if  $v_i = 75u(t)$  V.

Figure P13.68



- 13.69** a) Use the convolution integral to find  $v_o$  in the circuit in Fig. P13.69(a) if  $i_g$  is the pulse shown in Fig. P13.69(b).
- b) Use the convolution integral to find  $i_o$ .
- c) Show that your solutions for  $v_o$  and  $i_o$  are consistent by calculating  $v_o$  and  $i_o$  at  $100^-$  ms,  $100^+$  ms,  $200^-$  ms, and  $200^+$  ms.

Figure P13.69

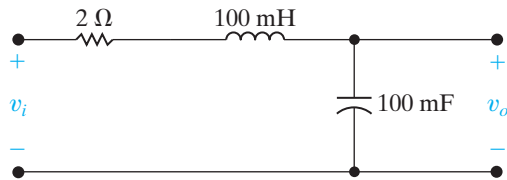


**13.70** The input voltage in the circuit seen in Fig. P13.70 is

$$v_i = 5[u(t) - u(t - 0.5)] \text{ V.}$$

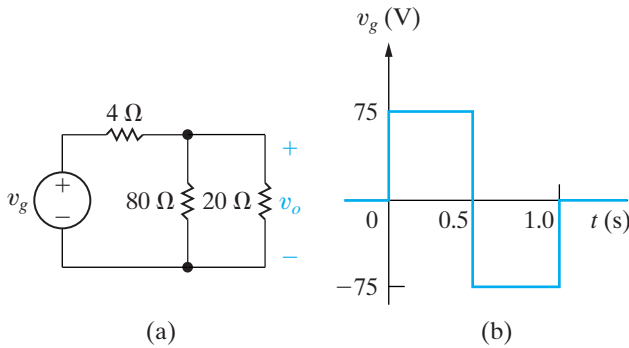
- Use the convolution integral to find  $v_o$ .
- Sketch  $v_o$  for  $0 \leq t \leq 1$  s.

**Figure P13.70**



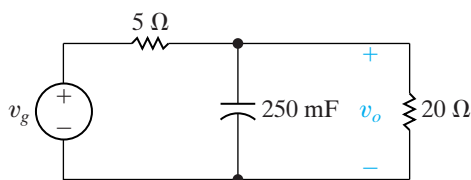
- 13.71**
- Find the impulse response of the circuit shown in Fig. P13.71(a) if  $v_g$  is the input signal and  $v_o$  is the output signal.
  - Given that  $v_g$  has the waveform shown in Fig. P13.71(b), use the convolution integral to find  $v_o$ .
  - Does  $v_o$  have the same waveform as  $v_g$ ? Why or why not?

**Figure P13.71**



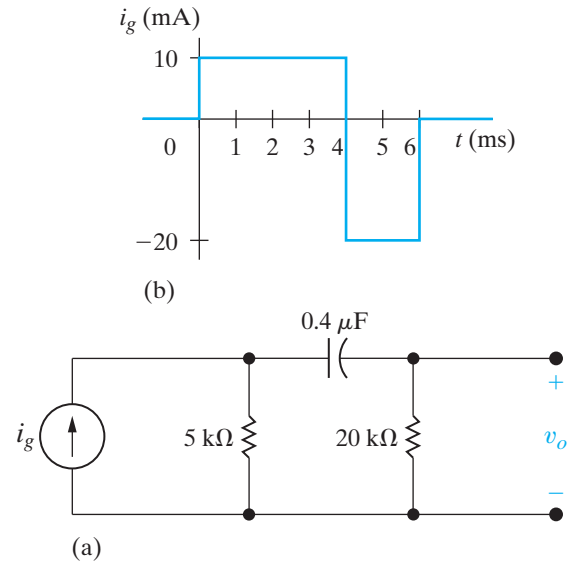
- 13.72**
- Find the impulse response of the circuit seen in Fig. P13.72 if  $v_g$  is the input signal and  $v_o$  is the output signal.
  - Assume that the voltage source has the waveform shown in Fig. P13.71(b). Use the convolution integral to find  $v_o$ .
  - Sketch  $v_o$  for  $0 \leq t \leq 2$  s.
  - Does  $v_o$  have the same waveform as  $v_g$ ? Why or why not?

**Figure P13.72**



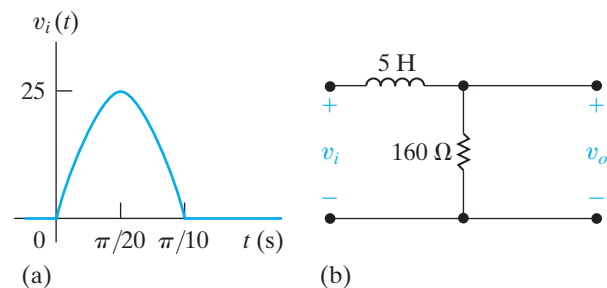
**13.73** The current source in the circuit shown in Fig. P13.73(a) is generating the waveform shown in Fig. P13.73(b). Use the convolution integral to find  $v_o$  at  $t = 5$  ms.

**Figure P13.73**



**13.74** The sinusoidal voltage pulse shown in Fig. P13.74(a) is applied to the circuit shown in Fig. P13.74(b). Use the convolution integral to find the value of  $v_o$  at  $t = 75$  ms.

**Figure P13.74**



- 13.75**
- Show that if  $y(t) = h(t) * x(t)$ , then  $Y(s) = H(s)X(s)$ .
  - Use the result given in (a) to find  $f(t)$  if

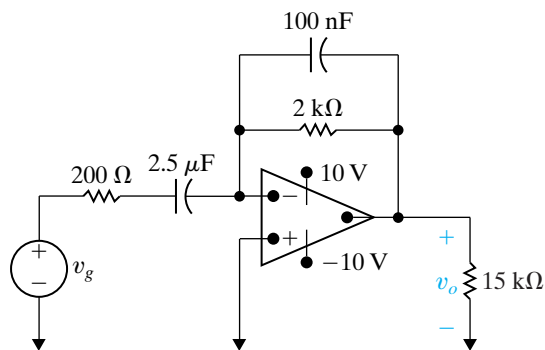
$$F(s) = \frac{a}{s(s + a)^2}.$$

**Section 13.7**

**13.76** The operational amplifier in the circuit seen in Fig. P13.76 is ideal and is operating within its linear region.

- Calculate the transfer function  $V_o/V_g$ .
- If  $v_g = \cos 3000t$  V, what is the steady-state expression for  $v_o$ ?

Figure P13.76

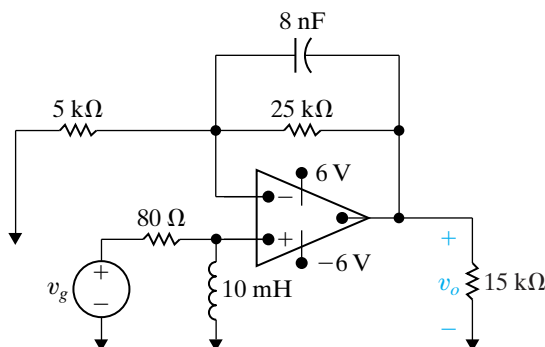


**13.77** The op amp in the circuit seen in Fig. P13.77 is ideal.

**PSPICE  
MULTISIM**

- Find the transfer function  $V_o/V_g$ .
- Find  $v_o$  if  $v_g = 0.6u(t)$  V.
- Find the steady-state expression for  $v_o$  if  $v_g = 2 \cos 10,000t$  V.

Figure P13.77



**13.78** The transfer function for a linear time-invariant circuit is

$$H(s) = \frac{V_o}{V_g} = \frac{25(s + 8)}{s^2 + 60s + 150}.$$

If  $v_g = 10 \cos 20t$  V, what is the steady-state expression for  $v_o$ ?

**13.79** The transfer function for a linear time-invariant circuit is

$$H(s) = \frac{I_o}{I_g} = \frac{125(s + 400)}{s(s^2 + 200s + 10^4)}.$$

If  $i_g = 80 \cos 500t$  A, what is the steady-state expression for  $i_o$ ?

**13.80** When an input voltage of  $30u(t)$  V is applied to a circuit, the response is known to be

$$v_o = (50e^{-8000t} - 20e^{-5000t})u(t) \text{ V}.$$

What will the steady-state response be if  $v_g = 120 \cos 6000t$  V?

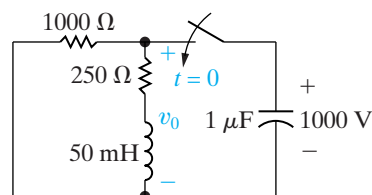
### Section 13.8

**13.81** Show that after  $V_0C_e$  coulombs are transferred from  $C_1$  to  $C_2$  in the circuit shown in Fig. 13.47, the voltage across each capacitor is  $C_1V_0/(C_1 + C_2)$ . (Hint: Use the conservation-of-charge principle.)

**13.82** The voltage source in the circuit in Example 13.1 is changed to a unit impulse; that is,  $v_g = \delta(t)$ .

- How much energy does the impulsive voltage source store in the capacitor?
- How much energy does it store in the inductor?
- Use the transfer function to find  $v_o(t)$ .
- Show that the response found in (c) is identical to the response generated by first charging the capacitor to 1000 V and then releasing the charge to the circuit, as shown in Fig. P13.82.

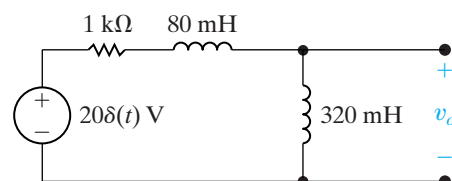
Figure P13.82



**13.83** There is no energy stored in the circuit in Fig. P13.83 at the time the impulsive voltage is applied.

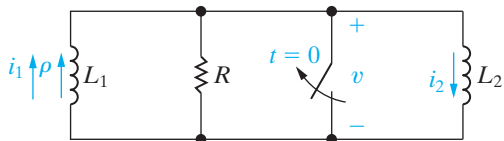
- Find  $v_o(t)$  for  $t \geq 0$ .
- Does your solution make sense in terms of known circuit behavior? Explain.

Figure P13.83



**13.84** The inductor  $L_1$  in the circuit shown in Fig. P13.84 is carrying an initial current of  $\rho$  A at the instant the switch opens. Find (a)  $v(t)$ ; (b)  $i_1(t)$ ; (c)  $i_2(t)$ ; and (d)  $\lambda(t)$ , where  $\lambda(t)$  is the total flux linkage in the circuit.

Figure P13.84

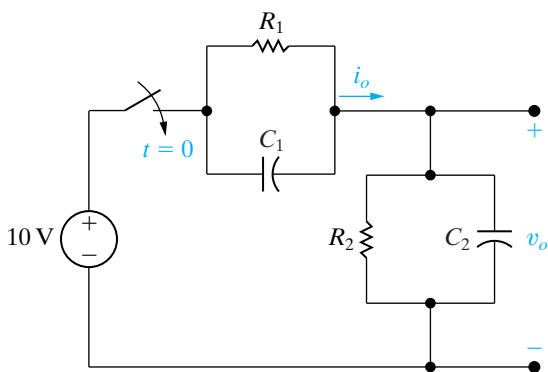


- 13.85** a) Let  $R \rightarrow \infty$  in the circuit shown in Fig. P13.84, and use the solutions derived in Problem 13.84 to find  $v(t)$ ,  $i_1(t)$ , and  $i_2(t)$ .  
 b) Let  $R = \infty$  in the circuit shown in Fig. P13.84 and use the Laplace transform method to find  $v(t)$ ,  $i_1(t)$ , and  $i_2(t)$ .

**13.86** The parallel combination of  $R_2$  and  $C_2$  in the circuit shown in Fig. P13.86 represents the input circuit to a cathode-ray oscilloscope (CRO). The parallel combination of  $R_1$  and  $C_1$  is a circuit model of a compensating lead that is used to connect the CRO to the source. There is no energy stored in  $C_1$  or  $C_2$  at the time when the 10 V source is connected to the CRO via the compensating lead. The circuit values are  $C_1 = 4$  pF,  $C_2 = 16$  pF,  $R_1 = 1.25$  M $\Omega$ , and  $R_2 = 5$  M $\Omega$ .

- a) Find  $v_o$ .  
 b) Find  $i_o$ .  
 c) Repeat (a) and (b) given  $C_1$  is changed to 64 pF.

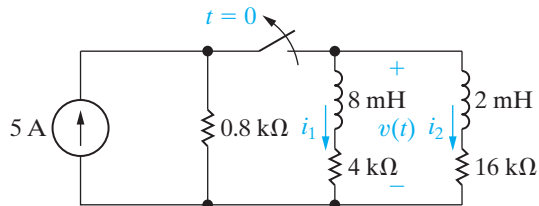
Figure P13.86



**13.87** Show that if  $R_1C_1 = R_2C_2$  in the circuit shown in Fig. P13.86,  $v_o$  will be a scaled replica of the source voltage.

**13.88** The switch in the circuit in Fig. P13.88 has been closed for a long time. The switch opens at  $t = 0$ . Compute (a)  $i_1(0^-)$ ; (b)  $i_1(0^+)$ ; (c)  $i_2(0^-)$ ; (d)  $i_2(0^+)$ ; (e)  $i_1(t)$ ; (f)  $i_2(t)$ ; and (g)  $v(t)$ .

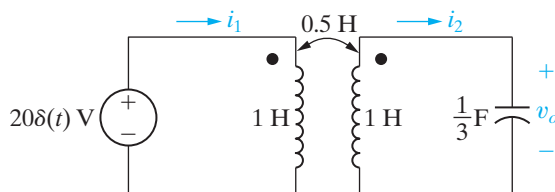
Figure P13.87



**13.89** There is no energy stored in the circuit in Fig. P13.89 at the time the impulse voltage is applied.

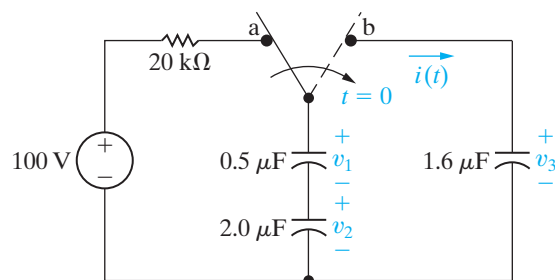
- a) Find  $i_1$  for  $t \geq 0^+$ .  
 b) Find  $i_2$  for  $t \geq 0^+$ .  
 c) Find  $v_o$  for  $t \geq 0^+$ .  
 d) Do your solutions for  $i_1$ ,  $i_2$ , and  $v_o$  make sense in terms of known circuit behavior? Explain.

Figure P13.89



**13.90** The switch in the circuit in Fig. P13.90 has been in position a for a long time. At  $t = 0$ , the switch moves to position b. Compute (a)  $v_1(0^-)$ ; (b)  $v_2(0^-)$ ; (c)  $v_3(0^-)$ ; (d)  $i(t)$ ; (e)  $v_1(0^+)$ ; (f)  $v_2(0^+)$ ; and (g)  $v_3(0^+)$ .

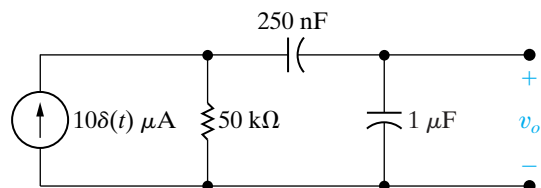
Figure P13.90



**13.91** There is no energy stored in the circuit in Fig. P13.91 at the time the impulsive current is applied.

- Find  $v_o$  for  $t \geq 0^+$ .
- Does your solution make sense in terms of known circuit behavior? Explain.

Figure P13.91



### Sections 13.1–13.8

**13.92** Assume the line-to-neutral voltage  $\mathbf{V}_o$  in the 60 Hz circuit of Fig. 13.59 is  $120 \angle 0^\circ$  V (rms). Load  $R_a$  is absorbing 1200 W; load  $R_b$  is absorbing 1800 W; and load  $X_a$  is absorbing 350 magnetizing VAR. The inductive reactance of the line ( $X_1$ ) is  $1 \Omega$ . Assume  $\mathbf{V}_g$  does not change after the switch opens.

PRACTICAL PERSPECTIVE

- Calculate the initial value of  $i_2(t)$  and  $i_o(t)$ .
- Find  $\mathbf{V}_o$ ,  $v_o(t)$ , and  $v_o(0^+)$  using the  $s$ -domain circuit of Fig. 13.60.
- Test the steady-state component of  $v_o$  using phasor domain analysis.
- Using a computer program of your choice, plot  $v_o$  vs.  $t$  for  $0 \leq t \leq 20$  ms.

**13.93** Assume the switch in the circuit in Fig. 13.59 opens at the instant the sinusoidal steady-state voltage  $v_o$  is zero and going positive, i.e.,  $v_o = 120\sqrt{2} \sin 120\pi t$  V.

PRACTICAL PERSPECTIVE

- Find  $v_o(t)$  for  $t \geq 0$ .
- Using a computer program of your choice, plot  $v_o(t)$  vs.  $t$  for  $0 \leq t \leq 20$  ms.
- Compare the disturbance in the voltage in part (a) with that obtained in part (c) of Problem 13.92.

**13.94** The purpose of this problem is to show that the line-to-neutral voltage in the circuit in Fig. 13.59 can go directly into steady state if the load  $R_b$  is disconnected from the circuit at precisely the right time. Let  $v_o = V_m \cos(120\pi t - \theta^\circ)$  V, where  $V_m = 120\sqrt{2}$ . Assume  $v_g$  does not change after  $R_b$  is disconnected.

PRACTICAL PERSPECTIVE

- Find the value of  $\theta$  (in degrees) so that  $v_o$  goes directly into steady-state operation when the load  $R_b$  is disconnected.
- For the value of  $\theta$  found in part (a), find  $v_o(t)$  for  $t \geq 0$ .
- Using a computer program of your choice, plot on a single graph, for  $-10$  ms  $\leq t \leq 10$  ms,  $v_o(t)$  before and after load  $R_b$  is disconnected.



# CHAPTER 14

## CHAPTER CONTENTS

- 14.1 Some Preliminaries p. 522
- 14.2 Low-Pass Filters p. 524
- 14.3 High-Pass Filters p. 530
- 14.4 Bandpass Filters p. 534
- 14.5 Bandreject Filters p. 543

## ✓ CHAPTER OBJECTIVES

- 1 Know the  $RL$  and  $RC$  circuit configurations that act as low-pass filters and be able to design  $RL$  and  $RC$  circuit component values to meet a specified cutoff frequency.
- 2 Know the  $RL$  and  $RC$  circuit configurations that act as high-pass filters and be able to design  $RL$  and  $RC$  circuit component values to meet a specified cutoff frequency.
- 3 Know the  $RLC$  circuit configurations that act as bandpass filters, understand the definition of and relationship among the center frequency, cutoff frequencies, bandwidth, and quality factor of a bandpass filter, and be able to design  $RLC$  circuit component values to meet design specifications.
- 4 Know the  $RLC$  circuit configurations that act as bandreject filters, understand the definition of and relationship among the center frequency, cutoff frequencies, bandwidth, and quality factor of a bandreject filter, and be able to design  $RLC$  circuit component values to meet design specifications.

# Introduction to Frequency Selective Circuits

**Up to this point** in our analysis of circuits with sinusoidal sources, the source frequency was held constant. In this chapter, we analyze the effect of varying source frequency on circuit voltages and currents. The result of this analysis is the **frequency response** of a circuit.

We've seen in previous chapters that a circuit's response depends on the types of elements in the circuit, the way the elements are connected, and the impedance of the elements. Although varying the frequency of a sinusoidal source does not change the element types or their connections, it does alter the impedance of capacitors and inductors, because the impedance of these elements is a function of frequency. As we will see, the careful choice of circuit elements, their values, and their connections to other elements enables us to construct circuits that pass to the output only those input signals that reside in a desired range of frequencies. Such circuits are called **frequency-selective circuits**. Many devices that communicate via electric signals, such as telephones, radios, televisions, and satellites, employ frequency-selective circuits.

Frequency-selective circuits are also called **filters** because of their ability to filter out certain input signals on the basis of frequency. Figure 14.1 on page 522 represents this ability in a simplistic way. To be more accurate, we should note that no practical frequency-selective circuit can perfectly or completely filter out selected frequencies. Rather, filters **attenuate**—that is, weaken or lessen the effect of—any input signals with frequencies outside frequencies outside a particular frequency band. Your home stereo system may have a graphic equalizer, which is an excellent example of a collection of filter circuits. Each band in the graphic equalizer is a filter that amplifies sounds (audible frequencies) in the frequency range of the band and attenuates frequencies outside of that band. Thus the graphic equalizer enables you to change the sound volume in each frequency band.

## Practical Perspective

### Pushbutton Telephone Circuits

In this chapter, we examine circuits in which the source frequency varies. The behavior of these circuits varies as the source frequency varies, because the impedance of the reactive components is a function of the source frequency. These frequency-dependent circuits are called **filters** and are used in many common electrical devices. In radios, filters are used to select one radio station's signal while rejecting the signals from others transmitting at different frequencies. In stereo systems, filters are used to adjust the relative strengths of the low- and high-frequency components of the audio signal. Filters are also used throughout telephone systems.

A pushbutton telephone produces tones that you hear when you press a button. You may have wondered about these tones. How are they used to tell the telephone system which button was pushed? Why are tones used at all? Why do the tones sound musical? How does the phone system tell the difference between button tones and the normal sounds of people talking or singing?

The telephone system was designed to handle audio signals—those with frequencies between 300 Hz and 3 kHz. Thus, all signals from the system to the user have to be audible—including the dial tone and the busy signal. Similarly, all signals from the user to the system have to be audible, including the signal that the user has pressed a button. It is important to distinguish button signals from the normal audio signal, so a dual-tone-multiple-frequency (DTMF) design is employed. When a number button is pressed, a unique pair of sinusoidal tones with very precise frequencies is sent by the phone to the telephone system. The DTMF frequency and timing specifications make it unlikely that a human voice could produce the exact tone pairs, even if the person were trying. In the central telephone facility, electric circuits monitor the audio signal, listening for the tone pairs that signal a number. In the Practical Perspective example at the end of the chapter, we will examine the design of the DTMF filters used to determine which button has been pushed.



Tom Grill/Corbis



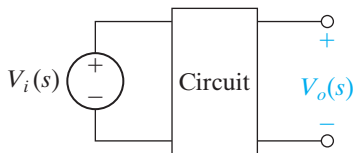
**Figure 14.1** ▲ The action of a filter on an input signal results in an output signal.

We begin this chapter by analyzing circuits from each of the four major categories of filters: low pass, high pass, band pass, and band reject. The transfer function of a circuit is the starting point for the frequency response analysis. Pay close attention to the similarities among the transfer functions of circuits that perform the same filtering function. We will employ these similarities when designing filter circuits in Chapter 15.

## 14.1 Some Preliminaries

Recall from Section 13.7 that the transfer function of a circuit provides an easy way to compute the steady-state response to a sinusoidal input. There, we considered only fixed-frequency sources. To study the frequency response of a circuit, we replace a fixed-frequency sinusoidal source with a varying-frequency sinusoidal source. The transfer function is still an immensely useful tool because the magnitude and phase of the output signal depend only on the magnitude and phase of the transfer function  $H(j\omega)$ .

Note that the approach just outlined assumes that we can vary the frequency of a sinusoidal source without changing its magnitude or phase angle. Therefore, the amplitude and phase of the output will vary only if those of the transfer function vary as the frequency of the sinusoidal source is changed.



**Figure 14.2** ▲ A circuit with voltage input and output.

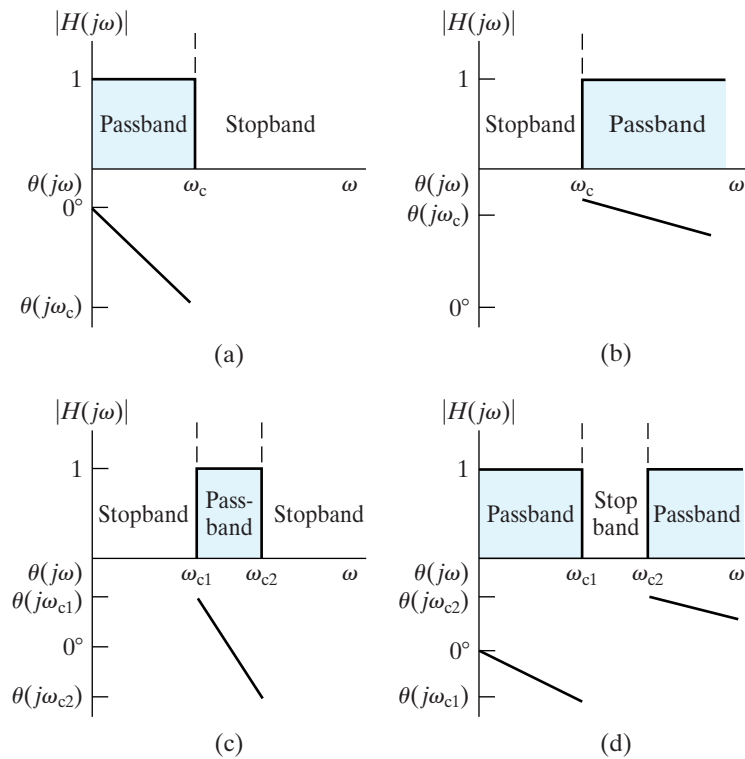
To further simplify this first look at frequency-selective circuits, we will also restrict our attention to cases where both the input and output signals are sinusoidal voltages, as illustrated in Fig. 14.2. Thus, the transfer function of interest to us will be the ratio of the Laplace transform of the output voltage to the Laplace transform of the input voltage, or  $H(s) = V_o(s)/V_i(s)$ . We should keep in mind, however, that for a particular application, a current may be either the input signal or output signal of interest.

The signals passed from the input to the output fall within a band of frequencies called the **passband**. Input voltages outside this band have their magnitudes attenuated by the circuit and are thus effectively prevented from reaching the output terminals of the circuit. Frequencies not in a circuit's passband are in its **stopband**. Frequency-selective circuits are categorized by the location of the passband.

One way of identifying the type of frequency-selective circuit is to examine a **frequency response plot**. A frequency response plot shows how a circuit's transfer function (both amplitude and phase) changes as the source frequency changes. A frequency response plot has two parts. One is a graph of  $|H(j\omega)|$  versus frequency  $\omega$ . This part of the plot is called the **magnitude plot**. The other part is a graph of  $\theta(j\omega)$  versus frequency  $\omega$ . This part is called the **phase angle plot**.

The ideal frequency response plots for the four major categories of filters are shown in Fig. 14.3. Parts (a) and (b) illustrate the ideal plots for a low-pass and a high-pass filter, respectively. Both filters have one passband and one stopband, which are defined by the **cutoff frequency** that separates them. The names *low pass* and *high pass* are derived from the magnitude plots: a **low-pass filter** passes signals at frequencies lower than the cutoff frequency from the input to the output, and a **high-pass filter** passes signals at frequencies higher than the cutoff frequency. Thus the terms *low* and *high* as used here do not refer to any absolute values of frequency, but rather to relative values with respect to the cutoff frequency.

Note from the graphs for both these filters (as well as those for the bandpass and bandreject filters) that the phase angle plot for an ideal filter varies linearly in the passband. It is of no interest outside the passband because there the magnitude is zero. Linear phase variation is necessary to avoid phase distortion.



**Figure 14.3** ▲ Ideal frequency response plots of the four types of filter circuits. (a) An ideal low-pass filter. (b) An ideal high-pass filter. (c) An ideal bandpass filter. (d) An ideal bandreject filter.

The two remaining categories of filters each have two cutoff frequencies. Figure 14.3(c) illustrates the ideal frequency response plot of a **bandpass filter**, which passes a source voltage to the output only when the source frequency is within the band defined by the two cutoff frequencies. Figure 14.3(d) shows the ideal plot of a **bandreject filter**, which passes a source voltage to the output only when the source frequency is outside the band defined by the two cutoff frequencies. The bandreject filter thus rejects, or stops, the source voltage from reaching the output when its frequency is within the band defined by the cutoff frequencies.

In specifying a realizable filter using any of the circuits from this chapter, it is important to note that the magnitude and phase angle characteristics are not independent. In other words, the characteristics of a circuit that result in a particular magnitude plot will also dictate the form of the phase angle plot and vice versa. For example, once we select a desired form for the magnitude response of a circuit, the phase angle response is also determined. Alternatively, if we select a desired form for the phase angle response, the magnitude response is also determined. Although there are some frequency-selective circuits for which the magnitude and phase angle behavior can be independently specified, these circuits are not presented here.

The next sections present examples of circuits from each of the four filter categories. They are a few of the many circuits that act as filters. You should focus your attention on trying to identify what properties of a circuit determine its behavior as a filter. Look closely at the form of the transfer function for circuits that perform the same filtering functions. Identifying the form of a filter's transfer function will ultimately help you in designing filtering circuits for particular applications.

All of the filters we will consider in this chapter are **passive filters**, so called because their filtering capabilities depend only on the passive

elements: resistors, capacitors, and inductors. The largest output amplitude such filters can achieve is usually 1, and placing an impedance in series with the source or in parallel with the load will decrease this amplitude. Because many practical filter applications require increasing the amplitude of the output, passive filters have some significant disadvantages. The only passive filter described in this chapter that can amplify its output is the series  $RLC$  resonant filter. A much greater selection of amplifying filters is found among the active filter circuits, the subject of Chapter 15.

## 14.2 Low-Pass Filters

Here, we examine two circuits that behave as low-pass filters, the series  $RL$  circuit and the series  $RC$  circuit, and discover what characteristics of these circuits determine the cutoff frequency.

### The Series $RL$ Circuit—Qualitative Analysis

A series  $RL$  circuit is shown in Fig. 14.4(a). The circuit's input is a sinusoidal voltage source with varying frequency. The circuit's output is defined as the voltage across the resistor. Suppose the frequency of the source starts very low and increases gradually. We know that the behavior of the ideal resistor will not change, because its impedance is independent of frequency. But consider how the behavior of the inductor changes.

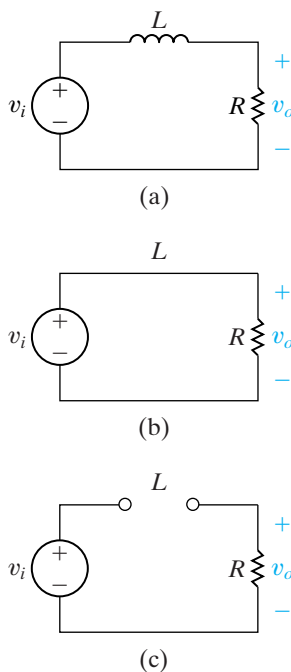
Recall that the impedance of an inductor is  $j\omega L$ . At low frequencies, the inductor's impedance is very small compared with the resistor's impedance, and the inductor effectively functions as a short circuit. The term *low frequencies* thus refers to any frequencies for which  $\omega L \ll R$ . The equivalent circuit for  $\omega = 0$  is shown in Fig. 14.4(b). In this equivalent circuit, the output voltage and the input voltage are equal both in magnitude and in phase angle.

As the frequency increases, the impedance of the inductor increases relative to that of the resistor. Increasing the inductor's impedance causes a corresponding increase in the magnitude of the voltage drop across the inductor and a corresponding decrease in the output voltage magnitude. Increasing the inductor's impedance also introduces a shift in phase angle between the inductor's voltage and current. This results in a phase angle difference between the input and output voltage. The output voltage lags the input voltage, and as the frequency increases, this phase lag approaches  $90^\circ$ .

At high frequencies, the inductor's impedance is very large compared with the resistor's impedance, and the inductor thus functions as an open circuit, effectively blocking the flow of current in the circuit. The term *high frequencies* thus refers to any frequencies for which  $\omega L \gg R$ . The equivalent circuit for  $\omega = \infty$  is shown in Fig. 14.4(c), where the output voltage magnitude is zero. The phase angle of the output voltage is  $90^\circ$  more negative than that of the input voltage.

Based on the behavior of the output voltage magnitude, this series  $RL$  circuit selectively passes low-frequency inputs to the output, and it blocks high-frequency inputs from reaching the output. This circuit's response to varying input frequency thus has the shape shown in Fig. 14.5. These two plots comprise the frequency response plots of the series  $RL$  circuit in Fig. 14.4(a). The upper plot shows how  $|H(j\omega)|$  varies with frequency. The lower plot shows how  $\theta(j\omega)$  varies as a function of frequency. We present a more formal method for constructing these plots in Appendix E.

We have also superimposed the ideal magnitude plot for a low-pass filter from Fig. 14.3(a) on the magnitude plot of the  $RL$  filter in Fig. 14.5. There is obviously a difference between the magnitude plots of an ideal



**Figure 14.4** ▲ (a) A series  $RL$  low-pass filter. (b) The equivalent circuit at  $\omega = 0$ . and (c) The equivalent circuit at  $\omega = \infty$ .



filter and the frequency response of an actual  $RL$  filter. The ideal filter exhibits a discontinuity in magnitude at the cutoff frequency,  $\omega_c$ , which creates an abrupt transition into and out of the passband. While this is, ideally, how we would like our filters to perform, it is not possible to use real components to construct a circuit that has this abrupt transition in magnitude. Circuits acting as low-pass filters have a magnitude response that changes gradually from the passband to the stopband. Hence the magnitude plot of a real circuit requires us to define what we mean by the cutoff frequency,  $\omega_c$ .

## Defining the Cutoff Frequency

We need to define the cutoff frequency,  $\omega_c$ , for realistic filter circuits when the magnitude plot does not allow us to identify a single frequency that divides the passband and the stopband. The definition for cutoff frequency widely used by electrical engineers is the frequency for which the transfer function magnitude is decreased by the factor  $1/\sqrt{2}$  from its maximum value:

$$|H(j\omega_c)| = \frac{1}{\sqrt{2}} H_{\max}, \quad (14.1)$$

where  $H_{\max}$  is the maximum magnitude of the transfer function. It follows from Eq. 14.1 that the passband of a realizable filter is defined as the range of frequencies in which the amplitude of the output voltage is at least 70.7% of the maximum possible amplitude.

The constant  $1/\sqrt{2}$  used in defining the cutoff frequency may seem like an arbitrary choice. Examining another consequence of the cutoff frequency will make this choice seem more reasonable. Recall from Section 10.5 that the average power delivered by any circuit to a load is proportional to  $V_L^2$ , where  $V_L$  is the amplitude of the voltage drop across the load:

$$P = \frac{1}{2} \frac{V_L^2}{R}. \quad (14.2)$$

If the circuit has a sinusoidal voltage source,  $V_i(j\omega)$ , then the load voltage is also a sinusoid, and its amplitude is a function of the frequency  $\omega$ . Define  $P_{\max}$  as the value of the average power delivered to a load when the magnitude of the load voltage is maximum:

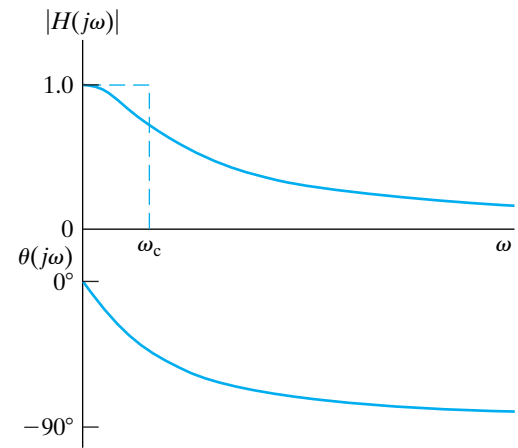
$$P_{\max} = \frac{1}{2} \frac{V_{L\max}^2}{R}. \quad (14.3)$$

If we vary the frequency of the sinusoidal voltage source,  $V_i(j\omega)$ , the load voltage is a maximum when the magnitude of the circuit's transfer function is also a maximum:

$$V_{L\max} = H_{\max}|V_i|. \quad (14.4)$$

Now consider what happens to the average power when the frequency of the voltage source is  $\omega_c$ . Using Eq. 14.1, we determine the magnitude of the load voltage at  $\omega_c$  to be

$$\begin{aligned} |V_L(j\omega_c)| &= |H(j\omega_c)||V_i| \\ &= \frac{1}{\sqrt{2}} H_{\max}|V_i| \\ &= \frac{1}{\sqrt{2}} V_{L\max}. \end{aligned} \quad (14.5)$$



**Figure 14.5** ▲ The frequency response plot for the series  $RL$  circuit in Fig. 14.4(a).

### ◀ Cutoff frequency definition

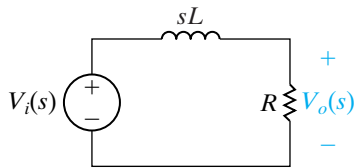
Substituting Eq. 14.5 into Eq. 14.2,

$$\begin{aligned}
 P(j\omega_c) &= \frac{1}{2} \frac{|V_L^2(j\omega_c)|}{R} \\
 &= \frac{1}{2} \frac{\left(\frac{1}{\sqrt{2}} V_{L\max}\right)^2}{R} \\
 &= \frac{1}{2} \frac{V_{L\max}^2/2}{R} \\
 &= \frac{P_{\max}}{2}.
 \end{aligned} \tag{14.6}$$

Equation 14.6 shows that at the cutoff frequency  $\omega_c$ , the average power delivered by the circuit is one half the maximum average power. Thus,  $\omega_c$  is also called the **half-power frequency**. Therefore, in the passband, the average power delivered to a load is at least 50% of the maximum average power.

### The Series $RL$ Circuit—Quantitative Analysis

Now that we have defined the cutoff frequency for real filter circuits, we can analyze the series  $RL$  circuit to discover the relationship between the component values and the cutoff frequency for this low-pass filter. We begin by constructing the  $s$ -domain equivalent of the circuit in Fig. 14.4(a), assuming initial conditions of zero. The resulting equivalent circuit is shown in Fig. 14.6.



**Figure 14.6** ▲ The  $s$ -domain equivalent for the circuit in Fig. 14.4(a).

The voltage transfer function for this circuit is

$$H(s) = \frac{R/L}{s + R/L}. \tag{14.7}$$

To study the frequency response, we make the substitution  $s = j\omega$  in Eq. 14.7:

$$H(j\omega) = \frac{R/L}{j\omega + R/L}. \tag{14.8}$$

We can now separate Eq. 14.8 into two equations. The first defines the transfer function magnitude as a function of frequency; the second defines the transfer function phase angle as a function of frequency:

$$|H(j\omega)| = \frac{R/L}{\sqrt{\omega^2 + (R/L)^2}}, \tag{14.9}$$

$$\theta(j\omega) = -\tan^{-1}\left(\frac{\omega L}{R}\right). \tag{14.10}$$

Close examination of Eq. 14.9 provides the quantitative support for the magnitude plot shown in Fig. 14.5. When  $\omega = 0$ , the denominator and the numerator are equal and  $|H(j0)| = 1$ . This means that at  $\omega = 0$ , the input voltage is passed to the output terminals without a change in the voltage magnitude.

As the frequency increases, the numerator of Eq. 14.9 is unchanged, but the denominator gets larger. Thus  $|H(j\omega)|$  decreases as the frequency increases, as shown in the plot in Fig. 14.5. Likewise, as the frequency increases, the phase angle changes from its dc value of  $0^\circ$ , becoming more negative, as seen from Eq. 14.10.

When  $\omega = \infty$ , the denominator of Eq. 14.9 is infinite and  $|H(j\infty)| = 0$ , as seen in Fig. 14.5. At  $\omega = \infty$ , the phase angle reaches a limit of  $-90^\circ$ , as seen from Eq. 14.10 and the phase angle plot in Fig. 14.5.

Using Eq. 14.9, we can compute the cutoff frequency,  $\omega_c$ . Remember that  $\omega_c$  is defined as the frequency at which  $|H(j\omega_c)| = (1/\sqrt{2})H_{\max}$ . For

the low-pass filter,  $H_{\max} = |H(j0)|$ , as seen in Fig. 14.5. Thus, for the circuit in Fig. 14.4(a),

$$|H(j\omega_c)| = \frac{1}{\sqrt{2}}|1| = \frac{R/L}{\sqrt{\omega_c^2 + (R/L)^2}}. \quad (14.11)$$

Solving Eq. 14.11 for  $\omega_c$ , we get

$$\omega_c = \frac{R}{L}. \quad (14.12) \quad \blacktriangleleft \text{Cutoff frequency for RL filters}$$

Equation 14.12 provides an important result. The cutoff frequency,  $\omega_c$ , can be set to any desired value by appropriately selecting values for  $R$  and  $L$ . We can therefore design a low-pass filter with whatever cutoff frequency is needed. Example 14.1 demonstrates the design potential of Eq. 14.12.

### Example 14.1 Designing a Low-Pass Filter

Electrocardiology is the study of the electric signals produced by the heart. These signals maintain the heart's rhythmic beat, and they are measured by an instrument called an electrocardiograph. This instrument must be capable of detecting periodic signals whose frequency is about 1 Hz (the normal heart rate is 72 beats per minute). The instrument must operate in the presence of sinusoidal noise consisting of signals from the surrounding electrical environment, whose fundamental frequency is 60 Hz—the frequency at which electric power is supplied.

Choose values for  $R$  and  $L$  in the circuit of Fig. 14.4(a) such that the resulting circuit could be used in an electrocardiograph to filter out any noise above 10 Hz and pass the electric signals from the heart at or near 1 Hz. Then compute the magnitude of  $V_o$  at 1 Hz, 10 Hz, and 60 Hz to see how well the filter performs.

#### Solution

The problem is to select values for  $R$  and  $L$  that yield a low-pass filter with a cutoff frequency of 10 Hz. From Eq. 14.12, we see that  $R$  and  $L$  cannot be specified independently to generate a value for  $\omega_c$ . Therefore, let's choose a commonly available value of  $L$ , 100 mH. Before we use Eq. 14.12 to compute the value of  $R$  needed to obtain the desired cutoff frequency, we need to convert the cutoff frequency from hertz to radians per second:

$$\omega_c = 2\pi(10) = 20\pi \text{ rad/s.}$$

Now, solve for the value of  $R$  which, together with  $L = 100$  mH, will yield a low-pass filter with a cutoff frequency of 10 Hz:

$$\begin{aligned} R &= \omega_c L \\ &= (20\pi)(100 \times 10^{-3}) \\ &= 6.28 \Omega. \end{aligned}$$

We can compute the magnitude of  $V_o$  using the equation  $|V_o| = |H(j\omega)| \cdot |V_i|$ :

$$\begin{aligned} |V_o(\omega)| &= \frac{R/L}{\sqrt{\omega^2 + (R/L)^2}} |V_i| \\ &= \frac{20\pi}{\sqrt{\omega^2 + 400\pi^2}} |V_i|. \end{aligned}$$

Table 14.1 summarizes the computed magnitude values for the frequencies 1 Hz, 10 Hz, and 60 Hz. As expected, the input and output voltages have the same magnitudes at the low frequency, because the circuit is a low-pass filter. At the cutoff frequency, the output voltage magnitude has been reduced by  $1/\sqrt{2}$  from the unity passband magnitude. At 60 Hz, the output voltage magnitude has been reduced by a factor of about 6, achieving the desired attenuation of the noise that could corrupt the signal the electrocardiograph is designed to measure.

TABLE 14.1 Input and Output Voltage Magnitudes for Several Frequencies

$f(\text{Hz})$	$ V_i  (\text{V})$	$ V_o  (\text{V})$
1	1.0	0.995
10	1.0	0.707
60	1.0	0.164



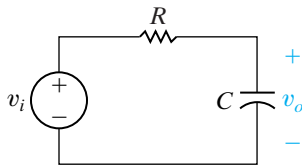


Figure 14.7 ▲ A series  $RC$  low-pass filter.

## A Series $RC$ Circuit

The series  $RC$  circuit shown in Fig. 14.7 also behaves as a low-pass filter. We can verify this via the same qualitative analysis we used previously. In fact, such a qualitative examination is an important problem-solving step that you should get in the habit of performing when analyzing filters. Doing so will enable you to predict the filtering characteristics (low pass, high pass, etc.) and thus also predict the general form of the transfer function. If the calculated transfer function matches the qualitatively predicted form, you have an important accuracy check.

Note that the circuit's output is defined as the output across the capacitor. As we did in the previous qualitative analysis, we use three frequency regions to develop the behavior of the series  $RC$  circuit in Fig. 14.7:

1. *Zero frequency* ( $\omega = 0$ ): The impedance of the capacitor is infinite, and the capacitor acts as an open circuit. The input and output voltages are thus the same.
2. *Frequencies increasing from zero*: The impedance of the capacitor decreases relative to the impedance of the resistor, and the source voltage divides between the resistive impedance and the capacitive impedance. The output voltage is thus smaller than the source voltage.
3. *Infinite frequency* ( $\omega = \infty$ ): The impedance of the capacitor is zero, and the capacitor acts as a short circuit. The output voltage is thus zero.

Based on this analysis of how the output voltage changes as a function of frequency, the series  $RC$  circuit functions as a low-pass filter. Example 14.2 explores this circuit quantitatively.

### Example 14.2 Designing a Series $RC$ Low-Pass Filter

For the series  $RC$  circuit in Fig. 14.7:

- a) Find the transfer function between the source voltage and the output voltage.
- b) Determine an equation for the cutoff frequency in the series  $RC$  circuit.
- c) Choose values for  $R$  and  $C$  that will yield a low-pass filter with a cutoff frequency of 3 kHz.

#### Solution

- a) To derive an expression for the transfer function, we first construct the  $s$ -domain equivalent of the circuit in Fig. 14.7, as shown in Fig. 14.8.

Using  $s$ -domain voltage division on the equivalent circuit, we find

$$H(s) = \frac{1}{s + \frac{1}{RC}}$$

Now, substitute  $s = j\omega$  and compute the magnitude of the resulting complex expression:

$$|H(j\omega)| = \frac{1}{\sqrt{\omega^2 + \left(\frac{1}{RC}\right)^2}}$$

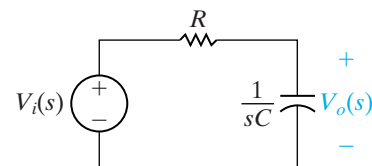


Figure 14.8 ▲ The  $s$ -domain equivalent for the circuit in Fig. 14.7.

- b) At the cutoff frequency  $\omega_c$ ,  $|H(j\omega)|$  is equal to  $(1/\sqrt{2})H_{\max}$ . For a low-pass filter,

$H_{\max} = H(j0)$ , and for the circuit in Fig. 14.8,  $H(j0) = 1$ . We can then describe the relationship among the quantities  $R$ ,  $C$ , and  $\omega_c$ :

$$|H(j\omega_c)| = \frac{1}{\sqrt{2}}(1) = \frac{\frac{1}{RC}}{\sqrt{\omega_c^2 + \left(\frac{1}{RC}\right)^2}}.$$

Solving this equation for  $\omega_c$ , we get

$$\omega_c = \frac{1}{RC}.$$

► **Cutoff frequency of RC filters**

c) From the results in (b), we see that the cutoff frequency is determined by the values of  $R$  and  $C$ . Because  $R$  and  $C$  cannot be computed independently, let's choose  $C = 1 \mu\text{F}$ . Given a choice, we will usually specify a value for  $C$  first, rather than for  $R$  or  $L$ , because the number of available capacitor values is much smaller than the number of resistor or inductor values. Remember that we have to convert the specified cutoff frequency from 3 kHz to  $(2\pi)(3)$  krad/s:

$$\begin{aligned} R &= \frac{1}{\omega_c C} \\ &= \frac{1}{(2\pi)(3 \times 10^3)(1 \times 10^{-6})} \\ &= 53.05 \Omega. \end{aligned}$$

Figure 14.9 summarizes the two low-pass filter circuits we have examined. Look carefully at the transfer functions. Notice how similar in form they are—they differ only in the terms that specify the cutoff frequency. In fact, we can state a general form for the transfer functions of these two low-pass filters:

$$H(s) = \frac{\omega_c}{s + \omega_c}. \quad (14.13)$$

◀ **Transfer function for a low-pass filter**

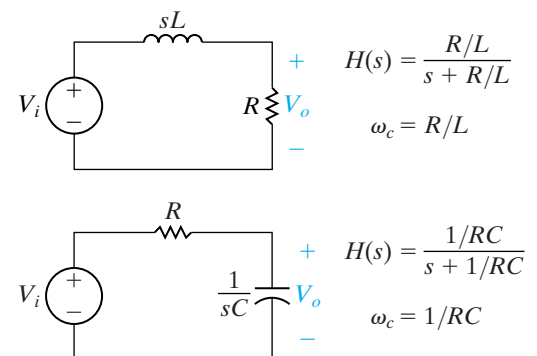
Any circuit with the voltage ratio in Eq. 14.13 would behave as a low-pass filter with a cutoff frequency of  $\omega_c$ . The problems at the end of the chapter give you other examples of circuits with this voltage ratio.

## Relating the Frequency Domain to the Time Domain

Finally, you might have noticed one other important relationship. Remember our discussion of the natural responses of the first-order  $RL$  and  $RC$  circuits in Chapter 6. An important parameter for these circuits is the time constant,  $\tau$ , which characterizes the shape of the time response. For the  $RL$  circuit, the time constant has the value  $L/R$  (Eq. 7.14); for the  $RC$  circuit, the time constant is  $RC$  (Eq. 7.24). Compare the time constants to the cutoff frequencies for these circuits and notice that

$$\tau = 1/\omega_c. \quad (14.14)$$

This result is a direct consequence of the relationship between the time response of a circuit and its frequency response, as revealed by the Laplace transform. The discussion of memory and weighting as represented in the convolution integral of Section 13.6 shows that as  $\omega_c \rightarrow \infty$ , the filter has no memory, and the output approaches a scaled replica of the input; that is, no filtering has occurred. As  $\omega_c \rightarrow 0$ , the filter has increased memory and the output voltage is a distortion of the input, because filtering has occurred.



**Figure 14.9** ▲ Two low-pass filters, the series  $RL$  and the series  $RC$ , together with their transfer functions and cutoff frequencies.

## ✓ ASSESSMENT PROBLEMS

**Objective 1**—Know the  $RL$  and  $RC$  circuit configurations that act as low-pass filters

**14.1** A series  $RC$  low-pass filter requires a cutoff frequency of 8 kHz. Use  $R = 10\text{ k}\Omega$  and compute the value of  $C$  required.

**Answer:** 1.99 nF.

*NOTE:* Also try ChapterProblems 14.1 and 14.7.

**14.2** A series  $RL$  low-pass filter with a cutoff frequency of 2 kHz is needed. Using  $R = 5\text{ k}\Omega$ , compute (a)  $L$ ; (b)  $|H(j\omega)|$  at 50 kHz; and (c)  $\theta(j\omega)$  at 50 kHz.

**Answer:** (a) 0.40 H;  
(b) 0.04;  
(c)  $-87.71^\circ$ .

## 14.3 High-Pass Filters

We next examine two circuits that function as high-pass filters. Once again, they are the series  $RL$  circuit and the series  $RC$  circuit. We will see that the same series circuit can act as either a low-pass or a high-pass filter, depending on where the output voltage is defined. We will also determine the relationship between the component values and the cutoff frequency of these filters.

### The Series $RC$ Circuit—Qualitative Analysis

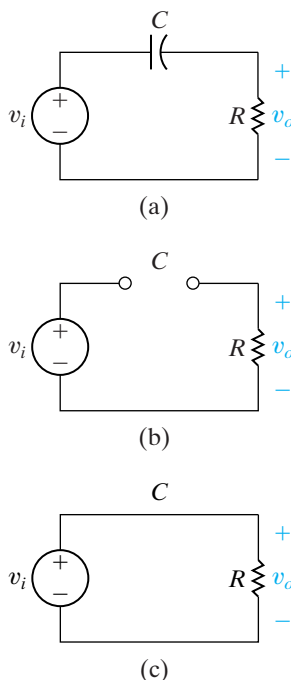
A series  $RC$  circuit is shown in Fig. 14.10(a). In contrast to its low-pass counterpart in Fig. 14.7, the output voltage here is defined across the resistor, not the capacitor. Because of this, the effect of the changing capacitive impedance is different than it was in the low-pass configuration.

At  $\omega = 0$ , the capacitor behaves like an open circuit, so there is no current flowing in the resistor. This is illustrated in the equivalent circuit in Fig. 14.10(b). In this circuit, there is no voltage across the resistor, and the circuit filters out the low-frequency source voltage before it reaches the circuit's output.

As the frequency of the voltage source increases, the impedance of the capacitor decreases relative to the impedance of the resistor, and the source voltage is now divided between the capacitor and the resistor. The output voltage magnitude thus begins to increase.

When the frequency of the source is infinite ( $\omega = \infty$ ), the capacitor behaves as a short circuit, and thus there is no voltage across the capacitor. This is illustrated in the equivalent circuit in Fig. 14.10(c). In this circuit, the input voltage and output voltage are the same.

The phase angle difference between the source and output voltages also varies as the frequency of the source changes. For  $\omega = \infty$ , the output voltage is the same as the input voltage, so the phase angle difference is zero. As the frequency of the source decreases and the impedance of the capacitor increases, a phase shift is introduced between the voltage and the current in the capacitor. This creates a phase difference between the source and output voltages. The phase angle of the output voltage leads that of the source voltage. When  $\omega = 0$ , this phase angle difference reaches its maximum of  $+90^\circ$ .



**Figure 14.10** ▲ (a) A series  $RC$  high-pass filter; (b) the equivalent circuit at  $\omega = 0$ ; and (c) the equivalent circuit at  $\omega = \infty$ .

Based on our qualitative analysis, we see that when the output is defined as the voltage across the resistor, the series  $RC$  circuit behaves as a high-pass filter. The components and connections are identical to the low-pass series  $RC$  circuit, but the choice of output is different. Thus, we have confirmed the earlier observation that the filtering characteristics of a circuit depend on the definition of the output as well as on circuit components, values, and connections.

Figure 14.11 shows the frequency response plot for the series  $RC$  high-pass filter. For reference, the dashed lines indicate the magnitude plot for an ideal high-pass filter. We now turn to a quantitative analysis of this same circuit.

### The Series $RC$ Circuit—Quantitative Analysis

To begin, we construct the  $s$ -domain equivalent of the circuit in Fig. 14.10(a). This equivalent is shown in Fig. 14.12. Applying  $s$ -domain voltage division to the circuit, we write the transfer function:

$$H(s) = \frac{s}{s + 1/RC}.$$

Making the substitution  $s = j\omega$  results in

$$H(j\omega) = \frac{j\omega}{j\omega + 1/RC}. \quad (14.15)$$

Next, we separate Eq. 14.15 into two equations. The first is the equation describing the magnitude of the transfer function; the second is the equation describing the phase angle of the transfer function:

$$|H(j\omega)| = \frac{\omega}{\sqrt{\omega^2 + (1/RC)^2}}, \quad (14.16)$$

$$\theta(j\omega) = 90^\circ - \tan^{-1}\omega RC. \quad (14.17)$$

A close look at Eqs. 14.16 and 14.17 confirms the shape of the frequency response plot in Fig. 14.11. Using Eq. 14.16, we can calculate the cutoff frequency for the series  $RC$  high-pass filter. Recall that at the cutoff frequency, the magnitude of the transfer function is  $(1/\sqrt{2})H_{\max}$ . For a high-pass filter,  $H_{\max} = |H(j\omega)|_{\omega=\infty} = |H(j\infty)|$ , as seen from Fig. 14.11. We can construct an equation for  $\omega_c$  by setting the left-hand side of Eq. 14.16 to  $(1/\sqrt{2})|H(j\infty)|$ , noting that for this series  $RC$  circuit,  $|H(j\infty)| = 1$ :

$$\frac{1}{\sqrt{2}} = \frac{\omega_c}{\sqrt{\omega_c^2 + (1/RC)^2}}. \quad (14.18)$$

Solving Eq. 14.18 for  $\omega_c$ , we get

$$\omega_c = \frac{1}{RC}. \quad (14.19)$$

Equation 14.19 presents a familiar result. The cutoff frequency for the series  $RC$  circuit has the value  $1/RC$ , whether the circuit is configured as a low-pass filter in Fig. 14.7 or as a high-pass filter in Fig. 14.10(a). This is perhaps not a surprising result, as we have already discovered a connection between the cutoff frequency,  $\omega_c$ , and the time constant,  $\tau$ , of a circuit.

Example 14.3 analyzes a series  $RL$  circuit, this time configured as a high-pass filter. Example 14.4 examines the effect of adding a load resistor in parallel with the inductor.

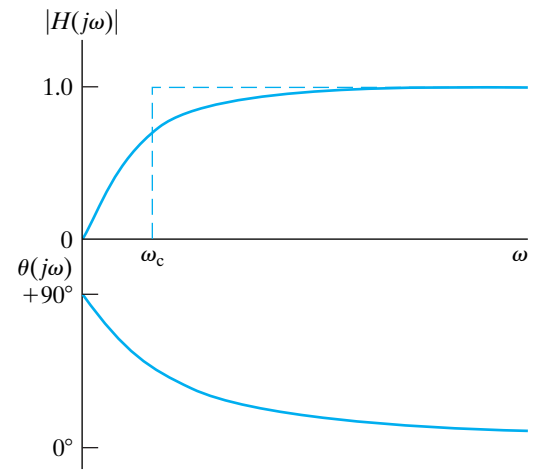


Figure 14.11 ▲ The frequency response plot for the series  $RC$  circuit in Fig. 14.10(a).

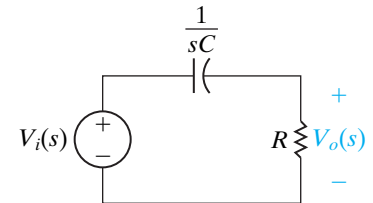
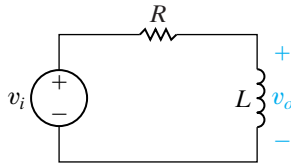


Figure 14.12 ▲ The  $s$ -domain equivalent of the circuit in Fig. 14.10(a).

**Example 14.3** Designing a Series  $RL$  High-Pass Filter

Show that the series  $RL$  circuit in Fig. 14.13 also acts like a high-pass filter:

- Derive an expression for the circuit's transfer function.
- Use the result from (a) to determine an equation for the cutoff frequency in the series  $RL$  circuit.
- Choose values for  $R$  and  $L$  that will yield a high-pass filter with a cutoff frequency of 15 kHz.



**Figure 14.13** ▲ The circuit for Example 14.3.

**Solution**

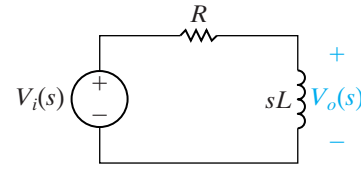
- Begin by constructing the  $s$ -domain equivalent of the series  $RL$  circuit, as shown in Fig. 14.14. Then use  $s$ -domain voltage division on the equivalent circuit to construct the transfer function:

$$H(s) = \frac{s}{s + R/L}$$

Making the substitution  $s = j\omega$ , we get

$$H(j\omega) = \frac{j\omega}{j\omega + R/L}$$

Notice that this equation has the same form as Eq. 14.15 for the series  $RC$  high-pass filter.



**Figure 14.14** ▲ The  $s$ -domain equivalent of the circuit in Fig. 14.13.

- To find an equation for the cutoff frequency, first compute the magnitude of  $H(j\omega)$ :

$$|H(j\omega)| = \frac{\omega}{\sqrt{\omega^2 + (R/L)^2}}$$

Then, as before, we set the left-hand side of this equation to  $(1/\sqrt{2})H_{\max}$ , based on the definition of the cutoff frequency  $\omega_c$ . Remember that  $H_{\max} = |H(j\infty)|$  for a high-pass filter, and for the series  $RL$  circuit,  $|H(j\infty)| = 1$ . We solve the resulting equation for the cutoff frequency:

$$\frac{1}{\sqrt{2}} = \frac{\omega_c}{\sqrt{\omega_c^2 + (R/L)^2}}, \quad \omega_c = \frac{R}{L}$$

This is the same cutoff frequency we computed for the series  $RL$  low-pass filter.

- Using the equation for  $\omega_c$  computed in (b), we recognize that it is not possible to specify values for  $R$  and  $L$  independently. Therefore, let's arbitrarily select a value of  $500 \Omega$  for  $R$ . Remember to convert the cutoff frequency to radians per second:

$$L = \frac{R}{\omega_c} = \frac{500}{(2\pi)(15,000)} = 5.31 \text{ mH.}$$

**Example 14.4** Loading the Series  $RL$  High-Pass Filter

Examine the effect of placing a load resistor in parallel with the inductor in the  $RL$  high-pass filter shown in Fig. 14.15:

- Determine the transfer function for the circuit in Fig. 14.15.
- Sketch the magnitude plot for the loaded  $RL$  high-pass filter, using the values for  $R$  and  $L$  from the circuit in Example 14.3(c) and letting  $R_L = R$ . On the same graph, sketch the magnitude plot for the unloaded  $RL$  high-pass filter of Example 14.3(c).

**Solution**

- Begin by transforming the circuit in Fig. 14.15 to the  $s$ -domain, as shown in Fig. 14.16. Use voltage division across the parallel combination of inductor and load resistor to compute the transfer function:

$$H(s) = \frac{\frac{R_L s L}{R_L + s L}}{R + \frac{R_L s L}{R_L + s L}} = \frac{\left(\frac{R_L}{R + R_L}\right)s}{s + \left(\frac{R_L}{R + R_L}\right)\frac{R}{L}} = \frac{Ks}{s + \omega_c},$$

where

$$K = \frac{R_L}{R + R_L}, \quad \omega_c = KR/L.$$

Note that  $\omega_c$  is the cutoff frequency of the loaded filter.

b) For the unloaded  $RL$  high-pass filter from Example 14.3(c), the passband magnitude is 1, and the cutoff frequency is 15 kHz. For the loaded  $RL$  high-pass filter,  $R = R_L = 500 \Omega$ , so  $K = 1/2$ . Thus, for the loaded filter, the passband magnitude is  $(1)(1/2) = 1/2$ , and the cutoff frequency is  $(15,000)(1/2) = 7.5$  kHz. A sketch of the magnitude plots of the loaded and unloaded circuits is shown in Fig. 14.17.

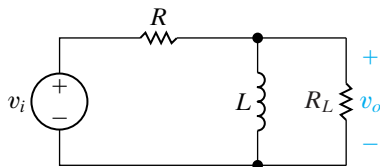


Figure 14.15 ▲ The circuit for Example 14.4.

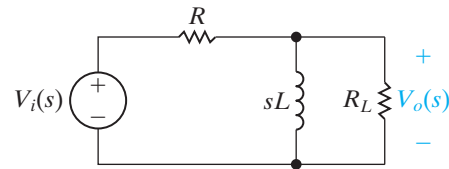


Figure 14.16 ▲ The  $s$ -domain equivalent of the circuit in Fig. 14.15.

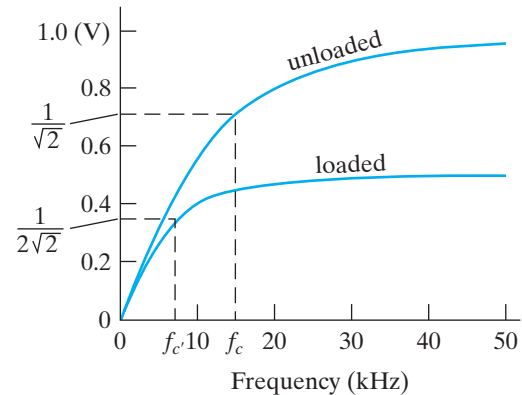


Figure 14.17 ▲ The magnitude plots for the unloaded  $RL$  high-pass filter of Fig. 14.13 and the loaded  $RL$  high-pass filter of Fig. 14.15.

Comparing the transfer functions of the unloaded filter in Example 14.3 and the loaded filter in Example 14.4 is useful at this point. Both transfer functions are in the form:

$$H(s) = \frac{Ks}{s + K(R/L)},$$

with  $K = 1$  for the unloaded filter and  $K = R_L/(R + R_L)$  for the loaded filter. Note that the value of  $K$  for the loaded circuit reduces to the value of  $K$  for the unloaded circuit when  $R_L = \infty$ ; that is, when there is no load resistor. The cutoff frequencies for both filters can be seen directly from their transfer functions. In both cases,  $\omega_c = K(R/L)$ , where  $K = 1$  for the unloaded circuit, and  $K = R_L/(R + R_L)$  for the loaded circuit. Again, the cutoff frequency for the loaded circuit reduces to that of the unloaded circuit when  $R_L = \infty$ . Because  $R_L/(R + R_L) < 1$ , the effect of the load resistor is to reduce the passband magnitude by the factor  $K$  and to lower the cutoff frequency by the same factor. We predicted these results at the beginning of this chapter. The largest output amplitude a passive high-pass filter can achieve is 1, and placing a load across the filter, as we did in Example 14.4, has served to decrease the amplitude. When we need to amplify signals in the passband, we must turn to active filters, such as those discussed in Chapter 15.

The effect of a load on a filter's transfer function poses another dilemma in circuit design. We typically begin with a transfer function specification and then design a filter to produce that function. We may or may not know what the load on the filter will be, but in any event, we usually want the filter's transfer function to remain the same regardless of the load on it. This desired behavior cannot be achieved with the passive filters presented in this chapter.

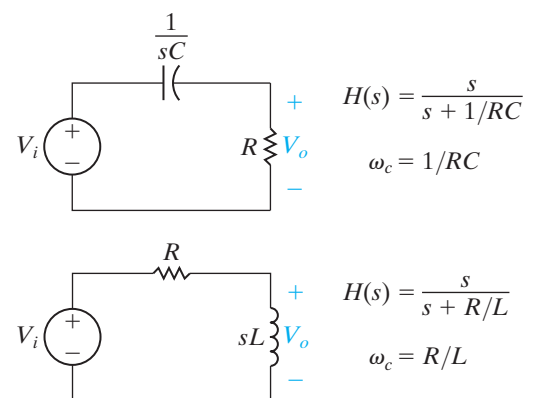


Figure 14.18 ▲ Two high-pass filters, the series  $RC$  and the series  $RL$ , together with their transfer functions and cutoff frequencies.

Figure 14.18 summarizes the high-pass filter circuits we have examined. Look carefully at the expressions for  $H(s)$ . Notice how similar in form these expressions are—they differ only in the denominator, which includes the cutoff frequency. As we did with the low-pass filters in Eq. 14.13, we state a general form for the transfer function of these two high-pass filters:

**Transfer function for a high-pass filter ►**

$$H(s) = \frac{s}{s + \omega_c}. \quad (14.20)$$

Any circuit with the transfer function in Eq. 14.20 would behave as a high-pass filter with a cutoff frequency of  $\omega_c$ . The problems at the end of the chapter give you other examples of circuits with this voltage ratio.

We have drawn attention to another important relationship. We have discovered that a series  $RC$  circuit has the same cutoff frequency whether it is configured as a low-pass filter or as a high-pass filter. The same is true of a series  $RL$  circuit. Having previously noted the connection between the cutoff frequency of a filter circuit and the time constant of that same circuit, we should expect the cutoff frequency to be a characteristic parameter of the circuit whose value depends only on the circuit components, their values, and the way they are connected.

## ✓ ASSESSMENT PROBLEMS

**Objective 2—Know the  $RL$  and  $RC$  circuit configurations that act as high-pass filters**

**14.3** A series  $RL$  high-pass filter has  $R = 5 \text{ k}\Omega$  and  $L = 3.5 \text{ mH}$ . What is  $\omega_c$  for this filter?

**Answer:** 1.43 Mrad/s.

**14.4** A series  $RC$  high-pass filter has  $C = 1 \text{ }\mu\text{F}$ . Compute the cutoff frequency for the following values of  $R$ : (a)  $100 \text{ }\Omega$ ; (b)  $5 \text{ k}\Omega$ ; and (c)  $30 \text{ k}\Omega$ .

**Answer:** (a) 10 krad/s;  
(b) 200 rad/s;  
(c) 33.33 rad/s.

**14.5** Compute the transfer function of a series  $RC$  low-pass filter that has a load resistor  $R_L$  in parallel with its capacitor.

**Answer:** 
$$H(s) = \frac{1}{s + \frac{1}{KRC}}, \text{ where } K = \frac{R_L}{R + R_L}.$$

*NOTE: Also try Chapter Problems 14.13 and 14.17.*

## 14.4 Bandpass Filters

The next filters we examine are those that pass voltages within a band of frequencies to the output while filtering out voltages at frequencies outside this band. These filters are somewhat more complicated than the low-pass and high-pass filters of the previous sections. As we have already seen in Fig. 14.3(c), ideal bandpass filters have two cutoff frequencies,  $\omega_{c1}$  and  $\omega_{c2}$ , which identify the passband. For realistic bandpass filters, these cutoff frequencies are again defined as the frequencies for which the magnitude of the transfer function equals  $(1/\sqrt{2})H_{\max}$ .

### Center Frequency, Bandwidth, and Quality Factor

There are three other important parameters that characterize a bandpass filter. The first is the **center frequency**,  $\omega_o$ , defined as the frequency for which a circuit's transfer function is purely real. Another name for the center



frequency is the **resonant frequency**. This is the same name given to the frequency that characterizes the natural response of the second-order circuits in Chapter 8, because they are the same frequencies! When a circuit is driven at the resonant frequency, we say that the circuit is *in resonance*, because the frequency of the forcing function is the same as the natural frequency of the circuit. The center frequency is the geometric center of the passband, that is,  $\omega_o = \sqrt{\omega_{c1}\omega_{c2}}$ . For bandpass filters, the magnitude of the transfer function is a maximum at the center frequency ( $H_{\max} = |H(j\omega_o)|$ ).

The second parameter is the **bandwidth**,  $\beta$ , which is the width of the passband. The final parameter is the **quality factor**, which is the ratio of the center frequency to the bandwidth. The quality factor gives a measure of the width of the passband, independent of its location on the frequency axis. It also describes the shape of the magnitude plot, independent of frequency.

Although there are five different parameters that characterize the bandpass filter— $\omega_{c1}$ ,  $\omega_{c2}$ ,  $\omega_o$ ,  $\beta$ , and  $Q$ —only two of the five can be specified independently. In other words, once we are able to solve for any two of these parameters, the other three can be calculated from the dependent relationships among them. We will define these quantities more specifically once we have analyzed a bandpass filter. In the next section, we examine two *RLC* circuits which act as bandpass filters, and then we derive expressions for all of their characteristic parameters.

### The Series *RLC* Circuit—Qualitative Analysis

Figure 14.19(a) depicts a series *RLC* circuit. We want to consider the effect of changing the source frequency on the magnitude of the output voltage. As before, changes to the source frequency result in changes to the impedance of the capacitor and the inductor. This time, the qualitative analysis is somewhat more complicated, because the circuit has both an inductor and a capacitor.

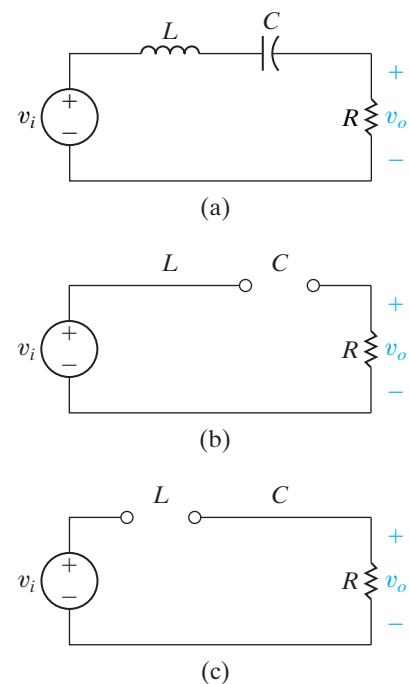
At  $\omega = 0$ , the capacitor behaves like an open circuit, and the inductor behaves like a short circuit. The equivalent circuit is shown in Fig. 14.19(b). The open circuit representing the impedance of the capacitor prevents current from reaching the resistor, and the resulting output voltage is zero.

At  $\omega = \infty$ , the capacitor behaves like a short circuit, and the inductor behaves like an open circuit. The equivalent circuit is shown in Fig. 14.19(c). The inductor now prevents current from reaching the resistor, and again the output voltage is zero.

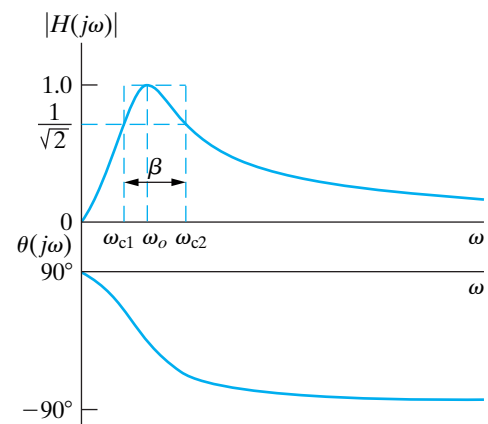
But what happens in the frequency region between  $\omega = 0$  and  $\omega = \infty$ ? Between these two extremes, both the capacitor and the inductor have finite impedances. In this region, voltage supplied by the source will drop across both the inductor and the capacitor, but some voltage will reach the resistor. Remember that the impedance of the capacitor is negative, whereas the impedance of the inductor is positive. Thus, at some frequency, the impedance of the capacitor and the impedance of the inductor have equal magnitudes and opposite signs; the two impedances cancel out, causing the output voltage to equal the source voltage. This special frequency is the center frequency,  $\omega_o$ . On either side of  $\omega_o$ , the output voltage is less than the source voltage. Note that at  $\omega_o$ , the series combination of the inductor and capacitor appears as a short circuit.

The plot of the voltage magnitude ratio is shown in Fig. 14.20. Note that the ideal bandpass filter magnitude plot is overlaid on the plot of the series *RLC* transfer function magnitude.

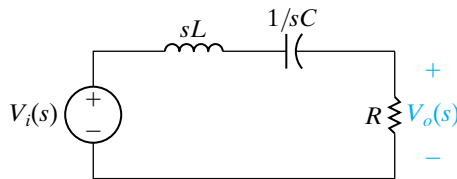
Now consider what happens to the phase angle of the output voltage. At the frequency where the source and output voltage are the same, the phase angles are the same. As the frequency decreases, the phase angle contribution from the capacitor is larger than that from the inductor.



**Figure 14.19** ▲ (a) A series *RLC* bandpass filter; (b) the equivalent circuit for  $\omega = 0$ ; and (c) the equivalent circuit for  $\omega = \infty$ .



**Figure 14.20** ▲ The frequency response plot for the series *RLC* bandpass filter circuit in Fig. 14.19.



**Figure 14.21** ▲ The  $s$ -domain equivalent for the circuit in Fig. 14.19(a).

Because the capacitor contributes positive phase shift, the net phase angle at the output is positive. At very low frequencies, the phase angle at the output maximizes at  $+90^\circ$ .

Conversely, if the frequency increases from the frequency at which the source and the output voltage are in phase, the phase angle contribution from the inductor is larger than that from the capacitor. The inductor contributes negative phase shift, so the net phase angle at the output is negative. At very high frequencies, the phase angle at the output reaches its negative maximum of  $-90^\circ$ . The plot of the phase angle difference thus has the shape shown in Fig. 14.20.

### The Series $RLC$ Circuit—Quantitative Analysis

We begin by drawing the  $s$ -domain equivalent for the series  $RLC$  circuit, as shown in Fig. 14.21. Use  $s$ -domain voltage division to write an equation for the transfer function:

$$H(s) = \frac{(R/L)s}{s^2 + (R/L)s + (1/LC)}. \quad (14.21)$$

As before, we substitute  $s = j\omega$  into Eq. 14.21 and produce the equations for the magnitude and the phase angle of the transfer function:

$$|H(j\omega)| = \frac{\omega(R/L)}{\sqrt{[(1/LC) - \omega^2]^2 + [\omega(R/L)]^2}}, \quad (14.22)$$

$$\theta(j\omega) = 90^\circ - \tan^{-1} \left[ \frac{\omega(R/L)}{(1/LC) - \omega^2} \right]. \quad (14.23)$$

We now calculate the five parameters that characterize this  $RLC$  band-pass filter. Recall that the center frequency,  $\omega_o$ , is defined as the frequency for which the circuit's transfer function is purely real. The transfer function for the  $RLC$  circuit in Fig. 14.19(a) will be real when the frequency of the voltage source makes the sum of the capacitor and inductor impedances zero:

$$j\omega_o L + \frac{1}{j\omega_o C} = 0. \quad (14.24)$$

Solving Eq. 14.24 for  $\omega_o$ , we get

**Center frequency** ►

$$\omega_o = \sqrt{\frac{1}{LC}}. \quad (14.25)$$

Next, calculate the cutoff frequencies,  $\omega_{c1}$  and  $\omega_{c2}$ . Remember that at the cutoff frequencies, the magnitude of the transfer function is  $(1/\sqrt{2})H_{\max}$ . Because  $H_{\max} = |H(j\omega_o)|$ , we can calculate  $H_{\max}$  by substituting Eq. 14.25 into Eq. 14.22:

$$\begin{aligned} H_{\max} &= |H(j\omega_o)| \\ &= \frac{\omega_o(R/L)}{\sqrt{[(1/LC) - \omega_o^2]^2 + (\omega_o R/L)^2}} \\ &= \frac{\sqrt{(1/LC)}(R/L)}{\sqrt{[(1/LC) - (1/LC)]^2 + [\sqrt{(1/LC)}(R/L)]^2}} = 1. \end{aligned}$$

Now set the left-hand side of Eq. 14.22 to  $(1/\sqrt{2})H_{\max}$  (which equals  $1/\sqrt{2}$ ) and prepare to solve for  $\omega_c$ :

$$\begin{aligned}\frac{1}{\sqrt{2}} &= \frac{\omega_c(R/L)}{\sqrt{[(1/LC) - \omega_c^2]^2 + (\omega_c R/L)^2}} \\ &= \frac{1}{\sqrt{[(\omega_c L/R) - (1/\omega_c RC)]^2 + 1}}.\end{aligned}\quad (14.26)$$

We can equate the denominators of the two sides of Eq. 14.26 to get

$$\pm 1 = \omega_c \frac{L}{R} - \frac{1}{\omega_c RC}.\quad (14.27)$$

Rearranging Eq. 14.27 results in the following quadratic equation:

$$\omega_c^2 L \pm \omega_c R - 1/C = 0.\quad (14.28)$$

The solution of Eq. 14.28 yields four values for the cutoff frequency. Only two of these values are positive and have physical significance; they identify the passband of this filter:

$$\omega_{c1} = -\frac{R}{2L} + \sqrt{\left(\frac{R}{2L}\right)^2 + \left(\frac{1}{LC}\right)},\quad (14.29)$$

$$\omega_{c2} = \frac{R}{2L} + \sqrt{\left(\frac{R}{2L}\right)^2 + \left(\frac{1}{LC}\right)}.\quad (14.30)$$

◀ Cutoff frequencies, series RLC filters

We can use Eqs. 14.29 and 14.30 to confirm that the center frequency,  $\omega_o$ , is the geometric mean of the two cutoff frequencies:

$$\omega_o = \sqrt{\omega_{c1} \cdot \omega_{c2}}$$

$$\begin{aligned}&= \sqrt{\left[-\frac{R}{2L} + \sqrt{\left(\frac{R}{2L}\right)^2 + \left(\frac{1}{LC}\right)}\right] \left[\frac{R}{2L} + \sqrt{\left(\frac{R}{2L}\right)^2 + \left(\frac{1}{LC}\right)}\right]} \\ &= \sqrt{\frac{1}{LC}}.\end{aligned}\quad (14.31)$$

◀ Relationship between center frequency and cutoff frequencies

Recall that the bandwidth of a bandpass filter is defined as the difference between the two cutoff frequencies. Because  $\omega_{c2} > \omega_{c1}$  we can compute the bandwidth by subtracting Eq. 14.29 from Eq. 14.30:

$$\beta = \omega_{c2} - \omega_{c1}$$

$$\begin{aligned}&= \left[\frac{R}{2L} + \sqrt{\left(\frac{R}{2L}\right)^2 + \left(\frac{1}{LC}\right)}\right] - \left[-\frac{R}{2L} + \sqrt{\left(\frac{R}{2L}\right)^2 + \left(\frac{1}{LC}\right)}\right] \\ &= \frac{R}{L}.\end{aligned}\quad (14.32)$$

◀ Relationship between bandwidth and cutoff frequencies

The quality factor, the last of the five characteristic parameters, is defined as the ratio of center frequency to bandwidth. Using Eqs. 14.25 and 14.32:

**Quality factor** ▶

$$\begin{aligned} Q &= \omega_o / \beta \\ &= \frac{(1/LC)}{(R/L)} \\ &= \sqrt{\frac{L}{CR^2}}. \end{aligned} \quad (14.33)$$

We now have five parameters that characterize the series  $RLC$  bandpass filter: two cutoff frequencies,  $\omega_{c1}$  and  $\omega_{c2}$ , which delimit the passband; the center frequency,  $\omega_o$ , at which the magnitude of the transfer function is maximum; the bandwidth,  $\beta$ , a measure of the width of the passband; and the quality factor,  $Q$ , a second measure of passband width. As previously noted, only two of these parameters can be specified independently in a design. We have already observed that the quality factor is specified in terms of the center frequency and the bandwidth. We can also rewrite the equations for the cutoff frequencies in terms of the center frequency and the bandwidth:

$$\omega_{c1} = -\frac{\beta}{2} + \sqrt{\left(\frac{\beta}{2}\right)^2 + \omega_o^2}, \quad (14.34)$$

$$\omega_{c2} = \frac{\beta}{2} + \sqrt{\left(\frac{\beta}{2}\right)^2 + \omega_o^2}. \quad (14.35)$$

Alternative forms for these equations express the cutoff frequencies in terms of the quality factor and the center frequency:

$$\omega_{c1} = \omega_o \cdot \left[ -\frac{1}{2Q} + \sqrt{1 + \left(\frac{1}{2Q}\right)^2} \right], \quad (14.36)$$

$$\omega_{c2} = \omega_o \cdot \left[ \frac{1}{2Q} + \sqrt{1 + \left(\frac{1}{2Q}\right)^2} \right]. \quad (14.37)$$

Also see Problem 14.24 at the end of the chapter.

The examples that follow illustrate the design of bandpass filters, introduce another  $RLC$  circuit that behaves as a bandpass filter, and examine the effects of source resistance on the characteristic parameters of a series  $RLC$  bandpass filter.

### Example 14.5 Designing a Bandpass Filter

A graphic equalizer is an audio amplifier that allows you to select different levels of amplification within different frequency regions. Using the series  $RLC$  circuit in Fig. 14.19(a), choose values for  $R$ ,  $L$ , and  $C$  that yield a bandpass circuit able to select inputs within the 1–10 kHz frequency band. Such a circuit might be used in a graphic equalizer to select this frequency band from the larger audio band (generally 0–20 kHz) prior to amplification.

### Solution

We need to compute values for  $R$ ,  $L$ , and  $C$  that produce a bandpass filter with cutoff frequencies of 1 kHz and 10 kHz. There are many possible approaches to a solution. For instance, we could use Eqs. 14.29 and 14.30, which specify  $\omega_{c1}$  and  $\omega_{c2}$  in terms of  $R$ ,  $L$ , and  $C$ . Because of the form of these equations, the algebraic manipulations might get

complicated. Instead, we will use the fact that the center frequency is the geometric mean of the cutoff frequencies to compute  $\omega_o$ , and we will then use Eq. 14.31 to compute  $L$  and  $C$  from  $\omega_o$ . Next we will use the definition of quality factor to compute  $Q$ , and last we will use Eq. 14.33 to compute  $R$ . Even though this approach involves more individual computational steps, each calculation is fairly simple.

Any approach we choose will provide only two equations—insufficient to solve for the three unknowns—because of the dependencies among the bandpass filter characteristics. Thus, we need to select a value for either  $R$ ,  $L$ , or  $C$  and use the two equations we've chosen to calculate the remaining component values. Here, we choose  $1\ \mu\text{F}$  as the capacitor value, because there are stricter limitations on commercially available capacitors than on inductors or resistors.

We compute the center frequency as the geometric mean of the cutoff frequencies:

$$f_o = \sqrt{f_{c1}f_{c2}} = \sqrt{(1000)(10,000)} = 3162.28\ \text{Hz}.$$

Next, compute the value of  $L$  using the computed center frequency and the selected value for  $C$ . We must remember to convert the center frequency to radians per second before we can use Eq. 14.31:

$$L = \frac{1}{\omega_o^2 C} = \frac{1}{[2\pi(3162.28)]^2(10^{-6})} = 2.533\ \text{mH}.$$

The quality factor,  $Q$ , is defined as the ratio of the center frequency to the bandwidth. The bandwidth is the difference between the two cutoff frequency values. Thus,

$$Q = \frac{f_o}{f_{c2} - f_{c1}} = \frac{3162.28}{10,000 - 1000} = 0.3514.$$

Now use Eq. 14.33 to calculate  $R$ :

$$R = \sqrt{\frac{L}{CQ^2}} = \sqrt{\frac{0.0025}{(10^{-6})(0.3514)^2}} = 143.24\ \Omega.$$

To check whether these component values produce the bandpass filter we want, substitute them into Eqs. 14.29 and 14.30. We find that

$$\omega_{c1} = 6283.19\ \text{rad/s}\ (1000\ \text{Hz}),$$

$$\omega_{c2} = 62,831.85\ \text{rad/s}\ (10,000\ \text{Hz}),$$

which are the cutoff frequencies specified for the filter.

This example reminds us that only two of the five bandpass filter parameters can be specified independently. The other three parameters can always be computed from the two that are specified. In turn, these five parameter values depend on the three component values,  $R$ ,  $L$ , and  $C$ , of which only two can be specified independently.

### Example 14.6 Designing a Parallel RLC Bandpass Filter

- Show that the RLC circuit in Fig. 14.22 is also a bandpass filter by deriving an expression for the transfer function  $H(s)$ .
- Compute the center frequency,  $\omega_o$ .
- Calculate the cutoff frequencies,  $\omega_{c1}$  and  $\omega_{c2}$ , the bandwidth,  $\beta$ , and the quality factor,  $Q$ .
- Compute values for  $R$  and  $L$  to yield a bandpass filter with a center frequency of 5 kHz and a bandwidth of 200 Hz, using a  $5\ \mu\text{F}$  capacitor.

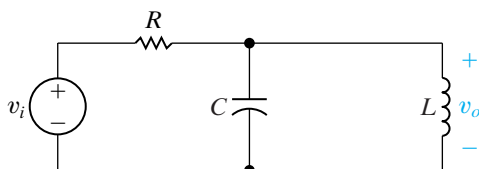


Figure 14.22 ▲ The circuit for Example 14.6.

### Solution

- Begin by drawing the  $s$ -domain equivalent of the circuit in Fig. 14.22, as shown in Fig. 14.23. Using voltage division, we can compute the transfer function for the equivalent circuit if we

first compute the equivalent impedance of the parallel combination of  $L$  and  $C$ , identified as  $Z_{\text{eq}}(s)$  in Fig. 14.23:

$$Z_{\text{eq}}(s) = \frac{\frac{L}{s}}{\frac{L}{s} + \frac{1}{sC}}.$$

Now,

$$H(s) = \frac{\frac{s}{RC}}{s^2 + \frac{s}{RC} + \frac{1}{LC}}.$$

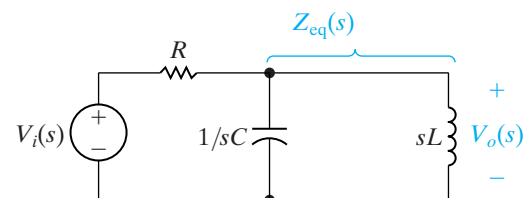


Figure 14.23 ▲ The  $s$ -domain equivalent of the circuit in Fig. 14.22.

- b) To find the center frequency, we need to calculate where the transfer function magnitude is maximum. Substituting  $s = j\omega$  in  $H(s)$ ,

$$|H(j\omega)| = \frac{\frac{\omega}{RC}}{\sqrt{\left(\frac{1}{LC} - \omega^2\right)^2 + \left(\frac{\omega}{RC}\right)^2}}$$

$$= \frac{1}{\sqrt{1 + \left(\omega RC - \frac{1}{\omega R}\right)^2}}$$

The magnitude of this transfer function is maximum when the term

$$\left(\frac{1}{LC} - \omega^2\right)^2$$

is zero. Thus,

$$\omega_o = \sqrt{\frac{1}{LC}}$$

and

$$H_{\max} = |H(j\omega_o)| = 1.$$

- c) At the cutoff frequencies, the magnitude of the transfer function is  $(1/\sqrt{2})H_{\max} = 1/\sqrt{2}$ . Substituting this constant on the left-hand side of the magnitude equation and then simplifying, we get

$$\left[ \omega_c RC - \frac{1}{\omega_c \frac{L}{R}} \right] = \pm 1.$$

Squaring the left-hand side of this equation once again produces two quadratic equations for the cutoff frequencies, with four solutions. Only two of them are positive and therefore have physical significance:

$$\omega_{c1} = -\frac{1}{2RC} + \sqrt{\left(\frac{1}{2RC}\right)^2 + \frac{1}{LC}},$$

$$\omega_{c2} = \frac{1}{2RC} + \sqrt{\left(\frac{1}{2RC}\right)^2 + \frac{1}{LC}}.$$

▲ Cutoff frequencies for parallel RLC filters

We compute the bandwidth from the cutoff frequencies:

$$\beta = \omega_{c2} - \omega_{c1}$$

$$= \frac{1}{RC}.$$

Finally, use the definition of quality factor to calculate  $Q$ :

$$Q = \omega_o/\beta$$

$$= \sqrt{\frac{R^2C}{L}}.$$

Notice that once again we can specify the cutoff frequencies for this bandpass filter in terms of its center frequency and bandwidth:

$$\omega_{c1} = \frac{\beta}{2} + \sqrt{\left(\frac{\beta}{2}\right)^2 + \omega_o^2},$$

$$\omega_{c2} = \frac{\beta}{2} + \sqrt{\left(\frac{\beta}{2}\right)^2 + \omega_o^2}.$$

- d) Use the equation for bandwidth in (c) to compute a value for  $R$ , given a capacitance of  $5 \mu\text{F}$ . Remember to convert the bandwidth to the appropriate units:

$$R = \frac{1}{\beta C}$$

$$= \frac{1}{(2\pi)(200)(5 \times 10^{-6})}$$

$$= 159.15 \Omega.$$

Using the value of capacitance and the equation for center frequency in (c), compute the inductor value:

$$L = \frac{1}{\omega_o^2 C}$$

$$= \frac{1}{[2\pi(5000)]^2(5 \times 10^{-6})}$$

$$= 202.64 \mu\text{H}.$$

### Example 14.7 Determining Effect of a Nonideal Voltage Source on a RLC Bandpass Filter

For each of the bandpass filters we have constructed, we have always assumed an ideal voltage source, that is, a voltage source with no series resistance. Even though this assumption is often valid, sometimes it is

not, as in the case where the filter design can be achieved only with values of  $R$ ,  $L$ , and  $C$  whose equivalent impedance has a magnitude close to the actual impedance of the voltage source. Examine the effect

of assuming a nonzero source resistance,  $R_i$ , on the characteristics of a series  $RLC$  bandpass filter.

- Determine the transfer function for the circuit in Fig. 14.24.
- Sketch the magnitude plot for the circuit in Fig. 14.24, using the values for  $R$ ,  $L$ , and  $C$  from Example 14.5 and setting  $R_i = R$ . On the same graph, sketch the magnitude plot for the circuit in Example 14.5, where  $R_i = 0$ .

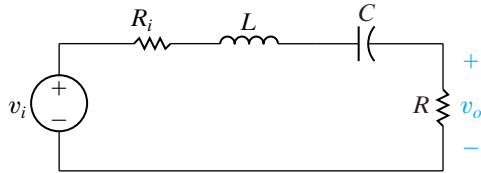


Figure 14.24 ▲ The circuit for Example 14.7.

### Solution

- Begin by transforming the circuit in Fig. 14.24 to its  $s$ -domain equivalent, as shown in Fig. 14.25. Now use voltage division to construct the transfer function:

$$H(s) = \frac{\frac{R}{L}s}{s^2 + \left(\frac{R + R_i}{L}\right)s + \frac{1}{LC}}$$

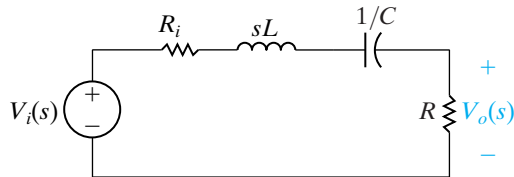


Figure 14.25 ▲ The  $s$ -domain equivalent of the circuit in Fig. 14.24.

Substitute  $s = j\omega$  and calculate the transfer function magnitude:

$$|H(j\omega)| = \frac{\frac{R}{L}\omega}{\sqrt{\left(\frac{1}{LC} - \omega^2\right)^2 + \left(\omega \frac{R + R_i}{L}\right)^2}}$$

The center frequency,  $\omega_o$ , is the frequency at which this transfer function magnitude is maximum, which is

$$\omega_o = \sqrt{\frac{1}{LC}}$$

At the center frequency, the maximum magnitude is

$$H_{\max} = |H(j\omega_o)| = \frac{R}{R_i + R}$$

The cutoff frequencies can be computed by setting the transfer function magnitude equal to  $(1/\sqrt{2})H_{\max}$ :

$$\omega_{c1} = -\frac{R + R_i}{2L} + \sqrt{\left(\frac{R + R_i}{2L}\right)^2 + \frac{1}{LC}}$$

$$\omega_{c2} = \frac{R + R_i}{2L} + \sqrt{\left(\frac{R + R_i}{2L}\right)^2 + \frac{1}{LC}}$$

The bandwidth is calculated from the cutoff frequencies:

$$\beta = \frac{R + R_i}{L}$$

Finally, the quality factor is computed from the center frequency and the bandwidth:

$$Q = \frac{\sqrt{L/C}}{R + R_i}$$

From this analysis, note that we can write the transfer function of the series  $RLC$  bandpass filter with nonzero source resistance as

$$H(s) = \frac{K\beta s}{s^2 + \beta s + \omega_o^2}$$

where

$$K = \frac{R}{R + R_i}$$

Note that when  $R_i = 0$ ,  $K = 1$  and the transfer function is

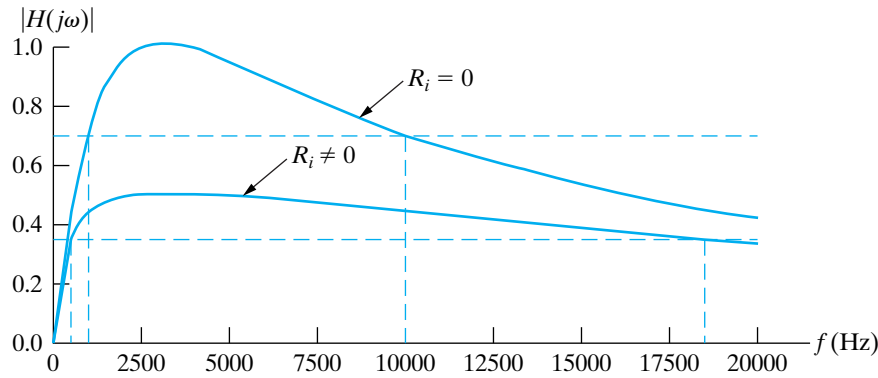
$$H(s) = \frac{\beta s}{s^2 + \beta s + \omega_o^2}$$

- The circuit in Example 14.5 has a center frequency of 3162.28 Hz and a bandwidth of 9 kHz, and  $H_{\max} = 1$ . If we use the same values for  $R$ ,  $L$ , and  $C$  in the circuit in Fig. 14.24 and let  $R_i = R$ , then the center frequency remains at

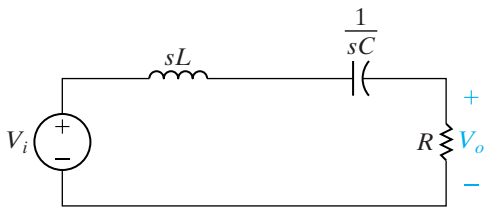


3162.28 kHz, but  $\beta = (R + R_i)/L = 18$  kHz, and  $H_{\max} = R/(R + R_i) = 1/2$ . The transfer

function magnitudes for these two bandpass filters are plotted on the same graph in Fig. 14.26.

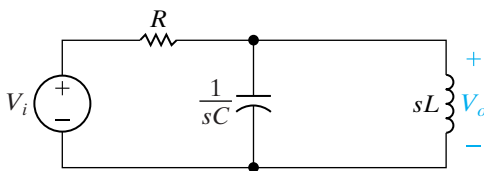


**Figure 14.26** ▲ The magnitude plots for a series *RLC* bandpass filter with a zero source resistance and a nonzero source resistance.



$$H(s) = \frac{(R/L)s}{s^2 + (R/L)s + 1/LC}$$

$$\omega_o = \sqrt{1/LC} \quad \beta = R/L$$



$$H(s) = \frac{s/RC}{s^2 + s/RC + 1/LC}$$

$$\omega_o = \sqrt{1/LC} \quad \beta = 1/RC$$

**Figure 14.27** ▲ Two *RLC* bandpass filters, together with equations for the transfer function, center frequency, and bandwidth of each.

If we compare the characteristic parameter values for the filter with  $R_i = 0$  to the values for the filter with  $R_i \neq 0$ , we see the following:

- The center frequencies are the same.
- The maximum transfer function magnitude for the filter with  $R_i \neq 0$  is smaller than for the filter with  $R_i = 0$ .
- The bandwidth for the filter with  $R_i \neq 0$  is larger than that for the filter with  $R_i = 0$ . Thus, the cutoff frequencies and the quality factors for the two circuits are also different.

The addition of a nonzero source resistance to a series *RLC* bandpass filter leaves the center frequency unchanged but widens the passband and reduces the passband magnitude.

Here we see the same design challenge we saw with the addition of a load resistor to the high-pass filter, that is, we would like to design a bandpass filter that will have the same filtering properties regardless of any internal resistance associated with the voltage source. Unfortunately, filters constructed from passive elements have their filtering action altered with the addition of source resistance. In Chapter 15, we will discover that active filters are insensitive to changes in source resistance and thus are better suited to designs in which this is an important issue.

Figure 14.27 summarizes the two *RLC* bandpass filters we have studied. Note that the expressions for the circuit transfer functions have the same form. As we have done previously, we can create a general form for the transfer functions of these two bandpass filters:

$$H(s) = \frac{\beta s}{s^2 + \beta s + \omega_o^2} \tag{14.38}$$

Any circuit with the transfer function in Eq. 14.38 acts as a bandpass filter with a center frequency  $\omega_o$  and a bandwidth  $\beta$ .

In Example 14.7, we saw that the transfer function can also be written in the form

$$H(s) = \frac{K\beta s}{s^2 + \beta s + \omega_o^2}, \tag{14.39}$$

where the values for  $K$  and  $\beta$  depend on whether the series resistance of the voltage source is zero or nonzero.

**Transfer function for *RLC* bandpass filter** ▶

## Relating the Frequency Domain to the Time Domain

We can identify a relationship between the parameters that characterize the frequency response of  $RLC$  bandpass filters and the parameters that characterize the time response of  $RLC$  circuits. Consider the series  $RLC$  circuit in Fig. 14.19(a). In Chapter 8 we discovered that the natural response of this circuit is characterized by the neper frequency ( $\alpha$ ) and the resonant frequency ( $\omega_o$ ). These parameters were expressed in terms of the circuit components in Eqs. 8.58 and 8.59, which are repeated here for convenience:

$$\alpha = \frac{R}{2L} \text{ rad/s}, \quad (14.40)$$

$$\omega_o = \sqrt{\frac{1}{LC}} \text{ rad/s}. \quad (14.41)$$

We see that the same parameter  $\omega_o$  is used to characterize both the time response and the frequency response. That's why the center frequency is also called the resonant frequency. The bandwidth and the neper frequency are related by the equation

$$\beta = 2\alpha. \quad (14.42)$$

Recall that the natural response of a series  $RLC$  circuit may be underdamped, overdamped, or critically damped. The transition from overdamped to underdamped occurs when  $\omega_o^2 = \alpha^2$ . Consider the relationship between  $\alpha$  and  $\beta$  from Eq. 14.42 and the definition of the quality factor  $Q$ . The transition from an overdamped to an underdamped response occurs when  $Q = 1/2$ . Thus, a circuit whose frequency response contains a sharp peak at  $\omega_o$ , indicating a high  $Q$  and a narrow bandwidth, will have an underdamped natural response. Conversely, a circuit whose frequency response has a broad bandwidth and a low  $Q$  will have an overdamped natural response.

### ✓ ASSESSMENT PROBLEMS

#### Objective 3—Know the $RLC$ circuit configurations that act as bandpass filters

**14.6** Using the circuit in Fig. 14.19(a), compute the values of  $R$  and  $L$  to give a bandpass filter with a center frequency of 12 kHz and a quality factor of 6. Use a  $0.1 \mu\text{F}$  capacitor.

**Answer:**  $L = 1.76 \text{ mH}$ ,  $R = 22.10 \Omega$ .

**14.7** Using the circuit in Fig. 14.22, compute the values of  $L$  and  $C$  to give a bandpass filter with a center frequency of 2 kHz and a bandwidth of 500 Hz. Use a  $250 \Omega$  resistor.

**Answer:**  $L = 4.97 \text{ mH}$ ,  $C = 1.27 \mu\text{F}$ .

**14.8** Recalculate the component values for the circuit in Example 14.6(d) so that the frequency response of the resulting circuit is unchanged using a  $0.2 \mu\text{F}$  capacitor.

**Answer:**  $L = 5.07 \text{ mH}$ ,  $R = 3.98 \text{ k}\Omega$ .

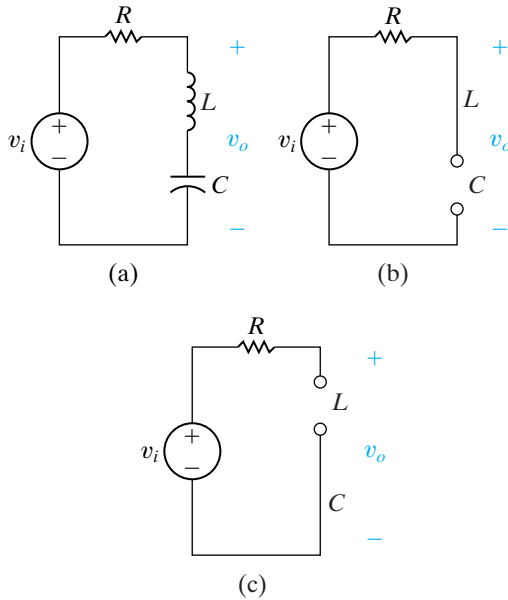
**14.9** Recalculate the component values for the circuit in Example 14.6(d) so that the quality factor of the resulting circuit is unchanged but the center frequency has been moved to 2 kHz. Use a  $0.2 \mu\text{F}$  capacitor.

**Answer:**  $R = 9.95 \text{ k}\Omega$ ,  $L = 31.66 \text{ mH}$ .

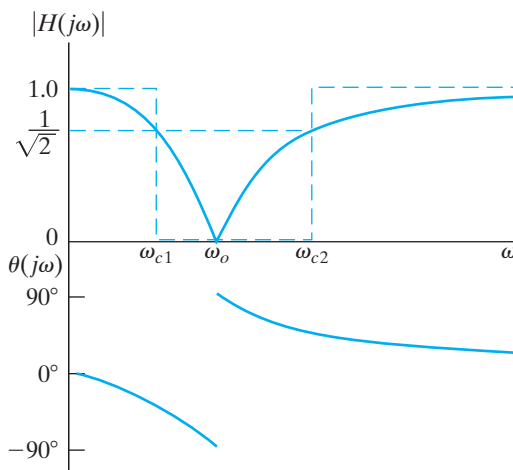
*NOTE:* Also try Chapter Problems 14.18 and 14.25.

## 14.5 Bandreject Filters

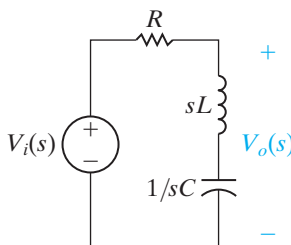
We turn now to the last of the four filter categories—the bandreject filter. This filter passes source voltages outside the band between the two cutoff frequencies to the output (the passband), and attenuates source voltages



**Figure 14.28** ▲ (a) A series *RLC* bandreject filter. (b) The equivalent circuit for  $\omega = 0$ . (c) The equivalent circuit for  $\omega = \infty$ .



**Figure 14.29** ▲ The frequency response plot for the series *RLC* bandreject filter circuit in Fig. 14.28(a).



**Figure 14.30** ▲ The *s*-domain equivalent of the circuit in Fig. 14.28(a).

before they reach the output at frequencies between the two cutoff frequencies (the stopband). Bandpass filters and bandreject filters thus perform complementary functions in the frequency domain.

Bandreject filters are characterized by the same parameters as bandpass filters: the two cutoff frequencies, the center frequency, the bandwidth, and the quality factor. Again, only two of these five parameters can be specified independently.

In the next sections, we examine two circuits that function as bandreject filters and then compute equations that relate the circuit component values to the characteristic parameters for each circuit.

### The Series *RLC* Circuit—Qualitative Analysis

Figure 14.28(a) shows a series *RLC* circuit. Although the circuit components and connections are identical to those in the series *RLC* bandpass filter in Fig. 14.19(a), the circuit in Fig. 14.28(a) has an important difference: the output voltage is now defined across the inductor-capacitor pair. As we saw in the case of low- and high-pass filters, the same circuit may perform two different filtering functions, depending on the definition of the output voltage.

We have already noted that at  $\omega = 0$ , the inductor behaves like a short circuit and the capacitor behaves like an open circuit, but at  $\omega = \infty$ , these roles switch. Figure 14.28(b) presents the equivalent circuit for  $\omega = 0$ ; Fig. 14.28(c) presents the equivalent circuit for  $\omega = \infty$ . In both equivalent circuits, the output voltage is defined over an effective open circuit, and thus the output and input voltages have the same magnitude. This series *RLC* bandreject filter circuit then has two passbands—one below a lower cutoff frequency, and the other above an upper cutoff frequency.

Between these two passbands, both the inductor and the capacitor have finite impedances of opposite signs. As the frequency is increased from zero, the impedance of the inductor increases and that of the capacitor decreases. Therefore the phase shift between the input and the output approaches  $-90^\circ$  as  $\omega L$  approaches  $1/\omega C$ . As soon as  $\omega L$  exceeds  $1/\omega C$ , the phase shift jumps to  $+90^\circ$  and then approaches zero as  $\omega$  continues to increase.

At some frequency between the two passbands, the impedances of the inductor and capacitor are equal but of opposite sign. At this frequency, the series combination of the inductor and capacitor is that of a short circuit, so the magnitude of the output voltage must be zero. This is the center frequency of this series *RLC* bandreject filter.

Figure 14.29 presents a sketch of the frequency response of the series *RLC* bandreject filter from Fig. 14.28(a). Note that the magnitude plot is overlaid with that of the ideal bandreject filter from Fig. 14.3(d). Our qualitative analysis has confirmed the shape of the magnitude and phase angle plots. We now turn to a quantitative analysis of the circuit to confirm this frequency response and to compute values for the parameters that characterize this response.

### The Series *RLC* Circuit—Quantitative Analysis

After transforming to the *s*-domain, as shown in Fig. 14.30, we use voltage division to construct an equation for the transfer function:

$$H(s) = \frac{sL + \frac{1}{sC}}{R + sL + \frac{1}{sC}} = \frac{s^2 + \frac{1}{LC}}{s^2 + \frac{R}{L}s + \frac{1}{LC}} \quad (14.43)$$

Substitute  $j\omega$  for  $s$  in Eq. 14.43 and generate equations for the transfer function magnitude and the phase angle:

$$|H(j\omega)| = \frac{\left| \frac{1}{LC} - \omega^2 \right|}{\sqrt{\left( \frac{1}{LC} - \omega^2 \right)^2 + \left( \frac{\omega R}{L} \right)^2}}, \quad (14.44)$$

$$\theta(j\omega) = -\tan^{-1} \left( \frac{\frac{\omega R}{L}}{\frac{1}{LC} - \omega^2} \right). \quad (14.45)$$

Note that Eqs. 14.44 and 14.45 confirm the frequency response shape pictured in Fig. 14.29, which we developed based on the qualitative analysis.

We use the circuit in Fig. 14.30 to calculate the center frequency. For the bandreject filter, the center frequency is still defined as the frequency for which the sum of the impedances of the capacitor and inductor is zero. In the bandpass filter, the magnitude at the center frequency was a maximum, but in the bandreject filter, this magnitude is a minimum. This is because in the bandreject filter, the center frequency is not in the passband; rather, it is in the stopband. It is easy to show that the center frequency is given by

$$\omega_o = \sqrt{\frac{1}{LC}}. \quad (14.46)$$

Substituting Eq. 14.46 into Eq. 14.44 shows that  $|H(j\omega_o)| = 0$ .

The cutoff frequencies, the bandwidth, and the quality factor are defined for the bandreject filter in exactly the way they were for the bandpass filters. Compute the cutoff frequencies by substituting the constant  $(1/\sqrt{2})H_{\max}$  for the left-hand side of Eq. 14.44 and then solving for  $\omega_{c1}$  and  $\omega_{c2}$ . Note that for the bandreject filter,  $H_{\max} = |H(j0)| = |H(j\infty)|$ , and for the series  $RLC$  bandreject filter in Fig. 14.28(a),  $H_{\max} = 1$ . Thus,

$$\omega_{c1} = -\frac{R}{2L} + \sqrt{\left( \frac{R}{2L} \right)^2 + \frac{1}{LC}}, \quad (14.47)$$

$$\omega_{c2} = \frac{R}{2L} + \sqrt{\left( \frac{R}{2L} \right)^2 + \frac{1}{LC}}. \quad (14.48)$$

Use the cutoff frequencies to generate an expression for the bandwidth,  $\beta$ :

$$\beta = R/L. \quad (14.49)$$

Finally, the center frequency and the bandwidth produce an equation for the quality factor,  $Q$ :

$$Q = \sqrt{\frac{L}{R^2C}}. \quad (14.50)$$

Again, we can represent the expressions for the two cutoff frequencies in terms of the bandwidth and center frequency, as we did for the band-pass filter:

$$\omega_{c1} = -\frac{\beta}{2} + \sqrt{\left(\frac{\beta}{2}\right)^2 + \omega_o^2}, \quad (14.51)$$

$$\omega_{c2} = \frac{\beta}{2} + \sqrt{\left(\frac{\beta}{2}\right)^2 + \omega_o^2}. \quad (14.52)$$

Alternative forms for these equations express the cutoff frequencies in terms of the quality factor and the center frequency:

$$\omega_{c1} = \omega_o \cdot \left[ -\frac{1}{2Q} + \sqrt{1 + \left(\frac{1}{2Q}\right)^2} \right], \quad (14.53)$$

$$\omega_{c2} = \omega_o \cdot \left[ \frac{1}{2Q} + \sqrt{1 + \left(\frac{1}{2Q}\right)^2} \right]. \quad (14.54)$$

Example 14.8 presents the design of a series *RLC* bandreject filter.

### Example 14.8 Designing a Series *RLC* Bandreject Filter

Using the series *RLC* circuit in Fig. 14.28(a), compute the component values that yield a bandreject filter with a bandwidth of 250 Hz and a center frequency of 750 Hz. Use a 100 nF capacitor. Compute values for  $R$ ,  $L$ ,  $\omega_{c1}$ ,  $\omega_{c2}$ , and  $Q$ .

#### Solution

We begin by using the definition of quality factor to compute its value for this filter:

$$Q = \omega_o / \beta = 3.$$

Use Eq. 14.46 to compute  $L$ , remembering to convert  $\omega_o$  to radians per second:

$$\begin{aligned} L &= \frac{1}{\omega_o^2 C} \\ &= \frac{1}{[2\pi(750)]^2 (100 \times 10^{-9})} \\ &= 450 \text{ mH}. \end{aligned}$$

Use Eq. 14.49 to calculate  $R$ :

$$\begin{aligned} R &= \beta L \\ &= 2\pi(250)(450 \times 10^{-3}) \\ &= 707 \Omega. \end{aligned}$$

The values for the center frequency and bandwidth can be used in Eqs. 14.51 and 14.52 to compute the two cutoff frequencies:

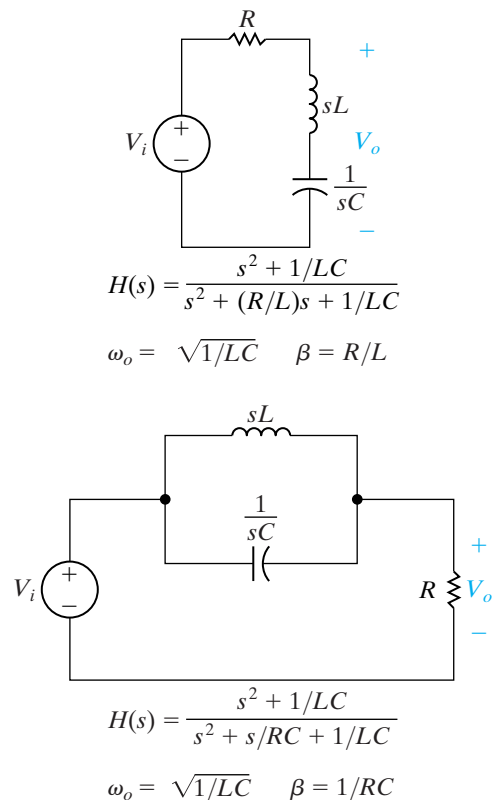
$$\begin{aligned} \omega_{c1} &= -\frac{\beta}{2} + \sqrt{\left(\frac{\beta}{2}\right)^2 + \omega_o^2} \\ &= 3992.0 \text{ rad/s}, \\ \omega_{c2} &= \frac{\beta}{2} + \sqrt{\left(\frac{\beta}{2}\right)^2 + \omega_o^2} \\ &= 5562.8 \text{ rad/s}. \end{aligned}$$

The cutoff frequencies are at 635.3 Hz and 885.3 Hz. Their difference is  $885.3 - 635.3 = 250$  Hz, confirming the specified bandwidth. The geometric mean is  $\sqrt{(635.3)(885.3)} = 750$  Hz, confirming the specified center frequency.

As you might suspect by now, another configuration that produces a bandreject filter is a parallel  $RLC$  circuit. Whereas the analysis details of the parallel  $RLC$  circuit are left to Problem 14.37, the results are summarized in Fig. 14.31, along with the series  $RLC$  bandreject filter. As we did for other categories of filters, we can state a general form for the transfer functions of bandreject filters, replacing the constant terms with  $\beta$  and  $\omega_o$ :

$$H(s) = \frac{s^2 + \omega_o^2}{s^2 + \beta s + \omega_o^2} \quad (14.55) \quad \blacktriangleleft \text{Transfer function for } RLC \text{ bandreject filter}$$

Equation 14.55 is useful in filter design, because any circuit with a transfer function in this form can be used as a bandreject filter.



**Figure 14.31**  $\blacktriangle$  Two  $RLC$  bandreject filters, together with equations for the transfer function, center frequency, and bandwidth of each.

## ✓ ASSESSMENT PROBLEMS

### Objective 4—Know the $RLC$ circuit configurations that act as bandreject filters

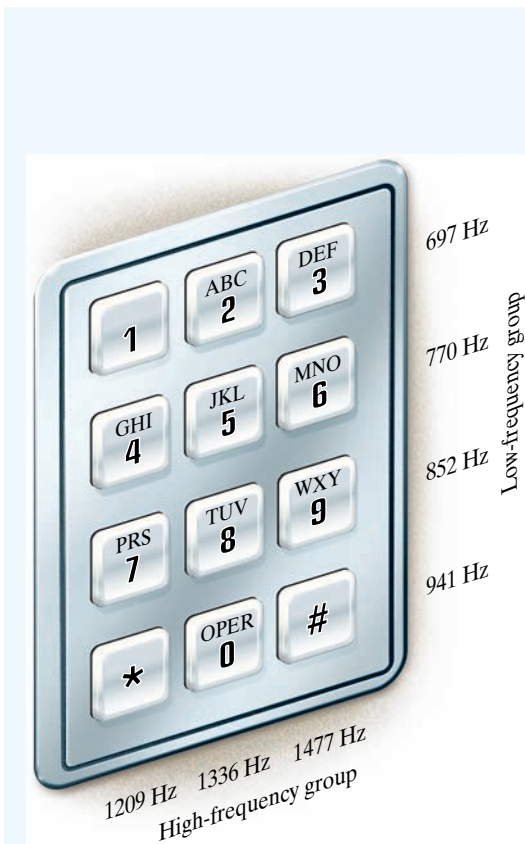
**14.10** Design the component values for the series  $RLC$  bandreject filter shown in Fig. 14.28(a) so that the center frequency is 4 kHz and the quality factor is 5. Use a 500 nF capacitor.

**Answer:**  $L = 3.17$  mH,  
 $R = 15.92$   $\Omega$ .

**14.11** Recompute the component values for Assessment Problem 14.10 to achieve a bandreject filter with a center frequency of 20 kHz. The filter has a 100  $\Omega$  resistor. The quality factor remains at 5.

**Answer:**  $L = 3.98$  mH,  
 $C = 15.92$  nF.

*NOTE:* Also try Chapter Problems 14.38 and 14.42.



**Figure 14.32** ▲ Tones generated by the rows and columns of telephone pushbuttons.

## Practical Perspective

### Pushbutton Telephone Circuits

In the Practical Perspective at the start of this chapter, we described the dual-tone-multiple-frequency (DTMF) system used to signal that a button has been pushed on a pushbutton telephone. A key element of the DTMF system is the DTMF receiver—a circuit that decodes the tones produced by pushing a button and determines which button was pushed.

In order to design a DTMF receiver, we need a better understanding of the DTMF system. As you can see from Fig. 14.32, the buttons on the telephone are organized into rows and columns. The pair of tones generated by pushing a button depends on the button's row and column. The button's row determines its low-frequency tone, and the button's column determines its high-frequency tone.<sup>1</sup> For example, pressing the “6” button produces sinusoidal tones with the frequencies 770 Hz and 1477 Hz.

At the telephone switching facility, bandpass filters in the DTMF receiver first detect whether tones from both the low-frequency and high-frequency groups are simultaneously present. This test rejects many extraneous audio signals that are not DTMF. If tones are present in both bands, other filters are used to select among the possible tones in each band so that the frequencies can be decoded into a unique button signal. Additional tests are performed to prevent false button detection. For example, only one tone per frequency band is allowed; the high- and low-band frequencies must start and stop within a few milliseconds of one another to be considered valid; and the high- and low-band signal amplitudes must be sufficiently close to each other.

You may wonder why bandpass filters are used instead of a high-pass filter for the high-frequency group of DTMF tones and a low-pass filter for the low-frequency group of DTMF tones. The reason is that the telephone system uses frequencies outside of the 300–3 kHz band for other signaling purposes, such as ringing the phone's bell. Bandpass filters prevent the DTMF receiver from erroneously detecting these other signals.

*NOTE: Assess your understanding of this Practical Perspective by trying Chapter Problems 14.51–14.53.*

<sup>1</sup> A fourth high-frequency tone is reserved at 1633 Hz. This tone is used infrequently and is not produced by a standard 12-button telephone.

## Summary

- A **frequency selective circuit**, or **filter**, enables signals at certain frequencies to reach the output, and it attenuates signals at other frequencies to prevent them from reaching the output. The **passband** contains the frequencies of those signals that are passed; the **stopband** contains the frequencies of those signals that are attenuated. (See page 522.)
- The **cutoff frequency**,  $\omega_c$ , identifies the location on the frequency axis that separates the stopband from the

passband. At the cutoff frequency, the magnitude of the transfer function equals  $(1/\sqrt{2})H_{\max}$ . (See page 525.)

- A **low-pass filter** passes voltages at frequencies below  $\omega_c$  and attenuates frequencies above  $\omega_c$ . Any circuit with the transfer function

$$H(s) = \frac{\omega_c}{s + \omega_c}$$

functions as a low-pass filter. (See page 529.)



- A **high-pass filter** passes voltages at frequencies above and attenuates voltages at frequencies below. Any circuit with the transfer function

$$H(s) = \frac{s}{s + \omega_c}$$

functions as a high-pass filter. (See page 534.)

- Bandpass filters and bandreject filters each have two cutoff frequencies,  $\omega_{c1}$  and  $\omega_{c2}$ . These filters are further characterized by their **center frequency** ( $\omega_o$ ), **bandwidth** ( $\beta$ ), and **quality factor** ( $Q$ ). These quantities are defined as

$$\omega_o = \sqrt{\omega_{c1} \cdot \omega_{c2}},$$

$$\beta = \omega_{c2} - \omega_{c1},$$

$$Q = \omega_o/\beta.$$

(See pages 537–538.)

- A **bandpass filter** passes voltages at frequencies within the passband, which is between  $\omega_{c1}$  and  $\omega_{c2}$ . It attenuates

frequencies outside of the passband. Any circuit with the transfer function

$$H(s) = \frac{\beta s}{s^2 + \beta s + \omega_o^2}$$

functions as a bandpass filter. (See page 542.)

- A **bandreject filter** attenuates voltages at frequencies within the stopband, which is between  $\omega_{c1}$  and  $\omega_{c2}$ . It passes frequencies outside of the stopband. Any circuit with the transfer function

$$H(s) = \frac{s^2 + \omega_o^2}{s^2 + \beta s + \omega_o^2}$$

functions as a bandreject filter. (See page 549.)

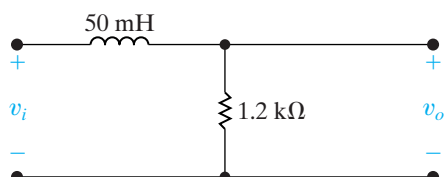
- Adding a load to the output of a passive filter changes its filtering properties by altering the location and magnitude of the passband. Replacing an ideal voltage source with one whose source resistance is nonzero also changes the filtering properties of the rest of the circuit, again by altering the location and magnitude of the passband. (See page 540.)

## Problems

### Section 14.2

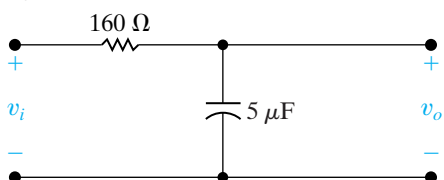
- 14.1** a) Find the cutoff frequency in hertz for the *RL* filter shown in Fig. P14.1.  
 b) Calculate  $H(j\omega)$  at  $\omega_c$ ,  $0.125\omega_c$ , and  $8\omega_c$ .  
 c) If  $v_i = 20 \cos \omega t$  V, write the steady-state expression for  $v_o$  when  $\omega = \omega_c$ ,  $\omega = 0.125\omega_c$ , and  $\omega = 8\omega_c$ .

Figure P14.1



- 14.2** a) Find the cutoff frequency (in hertz) of the low-pass filter shown in Fig. P14.2.  
 b) Calculate  $H(j\omega)$  at  $\omega_c$ ,  $0.1\omega_c$ , and  $10\omega_c$ .  
 c) If  $v_i = 25 \cos \omega t$  mV, write the steady-state expression for  $v_o$  when  $\omega = \omega_c$ ,  $0.1\omega_c$ , and  $10\omega_c$ .

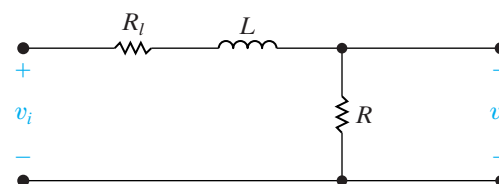
Figure P14.2



- 14.3** A resistor, denoted as  $R_L$ , is added in series with the inductor in the circuit in Fig. 14.4(a). The new low-pass filter circuit is shown in Fig. P14.3.

- a) Derive the expression for  $H(s)$  where  $H(s) = V_o/V_i$ .  
 b) At what frequency will the magnitude of  $H(j\omega)$  be maximum?  
 c) What is the maximum value of the magnitude of  $H(j\omega)$ ?  
 d) At what frequency will the magnitude of  $H(j\omega)$  equal its maximum value divided by  $\sqrt{2}$ ?  
 e) Assume a resistance of  $300 \Omega$  is added in series with the  $50 \text{ mH}$  inductor in the circuit in Fig. P14.1. Find  $\omega_c$ ,  $H(j0)$ ,  $H(j\omega_c)$ ,  $H(j0.2\omega_c)$ , and  $H(j5\omega_c)$ .

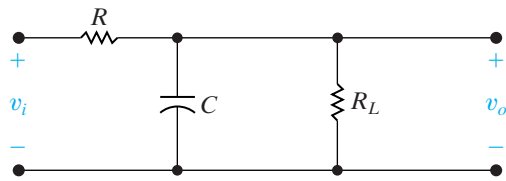
Figure P14.3



- 14.4** A resistor denoted as  $R_L$  is connected in parallel with the capacitor in the circuit in Fig. 14.7. The loaded low-pass filter circuit is shown in Fig. P14.7.

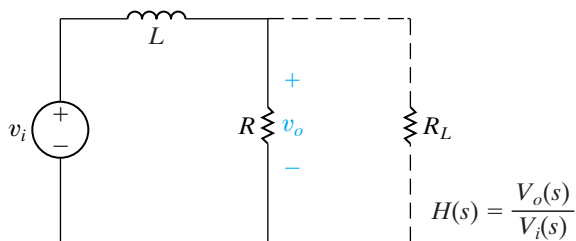
- Derive the expression for the voltage transfer function  $V_o/V_i$ .
- At what frequency will the magnitude of  $H(j\omega)$  be maximum?
- What is the maximum value of the magnitude of  $H(j\omega)$ ?
- At what frequency will the magnitude of  $H(j\omega)$  equal its maximum value divided by  $\sqrt{2}$ ?
- Assume a resistance of  $320\ \Omega$  is added in parallel with the  $5\ \mu\text{F}$  capacitor in the circuit in Fig. P14.4. Find  $\omega_c$ ,  $H(j0)$ ,  $H(j\omega_c)$ ,  $H(j0.2\omega_c)$ , and  $H(j5\omega_c)$ .

Figure P14.4



- 14.5** Study the circuit shown in Fig. P14.5 (without the load resistor).
- As  $\omega \rightarrow 0$ , the inductor behaves like what circuit component? What value will the output voltage  $v_o$  have?
  - As  $\omega \rightarrow \infty$ , the inductor behaves like what circuit component? What value will the output voltage  $v_o$  have?
  - Based on parts (a) and (b), what type of filtering does this circuit exhibit?
  - What is the transfer function of the unloaded filter?
  - If  $R = 330\ \Omega$  and  $L = 10\ \text{mH}$ , what is the cutoff frequency of the filter in rad/s?

Figure P14.5



- 14.6** Suppose we wish to add a load resistor in parallel with the resistor in the circuit shown in Fig. P14.5.
- What is the transfer function of the loaded filter?
  - Compare the transfer function of the unloaded filter (part (d) of Problem 14.5) and the transfer function of the loaded filter (part (a) of Problem 14.6). Are the cutoff frequencies different? Are the passband gains different?

- What is the smallest value of load resistance that can be used with the filter from Problem 14.5(e) such that the cutoff frequency of the resulting filter is no more than 5% different from the unloaded filter?

**14.7** Use a 1 mH inductor to design a low-pass,  $RL$ , passive filter with a cutoff frequency of 5 kHz.

DESIGN  
PROBLEM  
PSpICE  
MULTISIM

- Specify the value of the resistor.
- A load having a resistance of  $68\ \Omega$  is connected across the output terminals of the filter. What is the corner, or cutoff, frequency of the loaded filter in hertz?
- If you must use a single resistor from Appendix H for part (a), what resistor should you use? What is the resulting cutoff frequency of the filter?

### Section 14.3

**14.8** Use a 10 mH inductor to design a low-pass passive filter with a cutoff frequency of 1600 rad/s.

- Specify the cutoff frequency in hertz.
- Specify the value of the filter resistor.
- Assume the cutoff frequency cannot decrease by more than 10%. What is the smallest value of load resistance that can be connected across the output terminals of the filter?
- If the resistor found in (c) is connected across the output terminals, what is the magnitude of  $H(j\omega)$  when  $\omega = 0$ ?

**14.9** Design a passive  $RC$  low pass filter (see Fig. 14.7) with a cutoff frequency of 100 Hz using a  $4.7\ \mu\text{F}$  capacitor.

- What is the cutoff frequency in rad/s?
- What is the value of the resistor?
- Draw your circuit, labeling the component values and output voltage.
- What is the transfer function of the filter in part (c)?
- If the filter in part (c) is loaded with a resistor whose value is the same as the resistor part (b), what is the transfer function of this loaded filter?
- What is the cutoff frequency of the loaded filter from part (e)?
- What is the gain in the pass band of the loaded filter from part (e)?

**14.10** Use a 500 nF capacitor to design a low-pass passive filter with a cutoff frequency of 50 krad/s.

DESIGN  
PROBLEM  
PSpICE  
MULTISIM

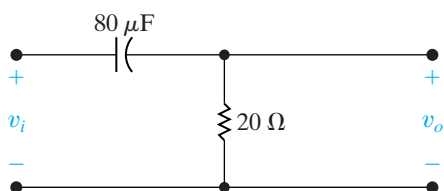
- Specify the cutoff frequency in hertz.
- Specify the value of the filter resistor.

- c) Assume the cutoff frequency cannot increase by more than 5%. What is the smallest value of load resistance that can be connected across the output terminals of the filter?
- d) If the resistor found in (c) is connected across the output terminals, what is the magnitude of  $H(j\omega)$  when  $\omega = 0$ ?

### Section 14.3

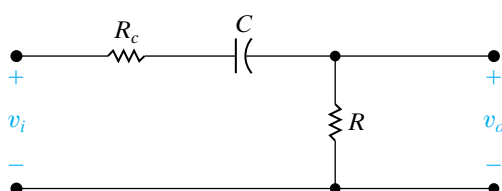
- 14.11** a) Find the cutoff frequency (in hertz) for the high-pass filter shown in Fig. P14.11.
- b) Find  $H(j\omega)$  at  $\omega_c$ ,  $0.125\omega_c$ , and  $8\omega_c$ .
- c) If  $v_i = 75 \cos \omega t$  V, write the steady-state expression for  $v_o$  when  $\omega = \omega_c$ ,  $\omega = 0.125\omega_c$ , and  $\omega = 8\omega_c$ .

Figure P14.11



- 14.12** A resistor, denoted as  $R_c$ , is connected in series with the capacitor in the circuit in Fig. 14.11(a). The new high-pass filter circuit is shown in Fig. P14.12.
- a) Derive the expression for  $H(s)$  where  $H(s) = V_o/V_i$ .
- b) At what frequency will the magnitude of  $H(j\omega)$  be maximum?
- c) What is the maximum value of the magnitude of  $H(j\omega)$ ?
- d) At what frequency will the magnitude of  $H(j\omega)$  equal its maximum value divided by  $\sqrt{2}$ ?
- e) Assume a resistance of  $5 \Omega$  is connected in series with the  $80 \mu\text{F}$  capacitor in the circuit in Fig. P14.11. Calculate  $\omega_c$ ,  $H(j\omega_c)$ ,  $H(j0.125\omega_c)$ , and  $H(j8\omega_c)$ .

Figure P14.12

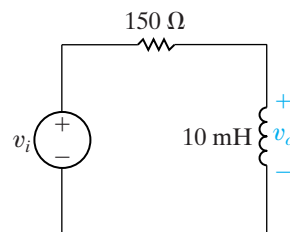


- 14.13** Using a  $100 \text{ nF}$  capacitor, design a high-pass passive filter with a cutoff frequency of  $300 \text{ Hz}$ .
- a) Specify the value of  $R$  in kilohms.
- b) A  $47 \text{ k}\Omega$  resistor is connected across the output terminals of the filter. What is the cutoff frequency, in hertz, of the loaded filter?

- 14.14** Consider the circuit shown in Fig. P14.14.

- a) With the input and output voltages shown in the figure, this circuit behaves like what type of filter?
- b) What is the transfer function,  $H(s) = V_o(s)/V_i(s)$ , of this filter?
- c) What is the cutoff frequency of this filter?
- d) What is the magnitude of the filter's transfer function at  $s = j\omega_c$ ?

Figure P14.14



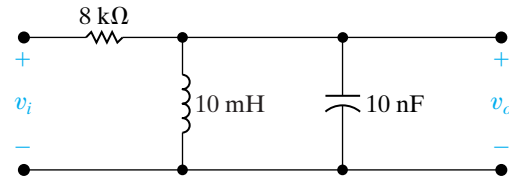
- 14.15** Suppose a  $150 \Omega$  load resistor is attached to the filter in Fig. P14.14.
- a) What is the transfer function,  $H(s) = V_o(s)/V_i(s)$ , of this filter?
- b) What is the cutoff frequency of this filter?
- c) How does the cutoff frequency of the loaded filter compare with the cutoff frequency of the unloaded filter in Fig. P14.14?
- d) What else is different for these two filters?
- 14.16** Design a passive  $RC$  high pass filter (see Fig. 14.10[a]) with a cutoff frequency of  $500 \text{ Hz}$  using a  $220 \text{ pF}$  capacitor.
- a) What is the cutoff frequency in rad/s?
- b) What is the value of the resistor?
- c) Draw your circuit, labeling the component values and output voltage.
- d) What is the transfer function of the filter in part (c)?
- e) If the filter in part (c) is loaded with a resistor whose value is the same as the resistor in (b), what is the transfer function of this loaded filter?
- f) What is the cutoff frequency of the loaded filter from part (e)?
- g) What is the gain in the pass band of the loaded filter from part (e)?
- 14.17** Using a  $100 \mu\text{H}$  inductor, design a high-pass,  $RL$ , passive filter with a cutoff frequency of  $1500 \text{ krad/s}$ .
- a) Specify the value of the resistance, selecting from the components in Appendix H.
- b) Assume the filter is connected to a pure resistive load. The cutoff frequency is not to drop below  $1200 \text{ krad/s}$ . What is the smallest load resistor from Appendix H that can be connected across the output terminals of the filter?

## Section 14.4

- 14.18** For the bandpass filter shown in Fig. P14.18, find (a)  $\omega_o$ , (b)  $f_o$ , (c)  $Q$ , (d)  $\omega_{c1}$ , (e)  $f_{c1}$ , (f)  $\omega_{c2}$ , (g)  $f_{c2}$ , and (h)  $\beta$ .

PSPICE  
MULTISIM

Figure P14.18



- 14.19** Calculate the center frequency, the bandwidth, and the quality factor of a bandpass filter that has an upper cutoff frequency of 121 krad/s and a lower cutoff frequency of 100 krad/s.

- 14.20** A bandpass filter has a center, or resonant, frequency of 50 krad/s and a quality factor of 4. Find the bandwidth, the upper cutoff frequency, and the lower cutoff frequency. Express all answers in kilohertz.

- 14.21** Design a series  $RLC$  bandpass filter (see Fig. 14.19[a]) with a quality of 8 and a center frequency of 50 krad/s, using a  $0.01 \mu\text{F}$  capacitor.

- Draw your circuit, labeling the component values and output voltage.
- For the filter in part (a), calculate the bandwidth and the values of the two cutoff frequencies.

- 14.22** The input to the series  $RLC$  bandpass filter designed in Problem 14.21 is  $5\cos\omega t$  V. Find the voltage drop across the resistor when (a)  $\omega = \omega_o$ ; (b)  $\omega = \omega_{c1}$ ; (c)  $\omega = \omega_{c2}$ ; (d)  $\omega = 0.1\omega_o$ ; (e)  $\omega = 10\omega_o$ .

- 14.23** The input to the series  $RLC$  bandpass filter designed in Problem 14.21 is  $5\cos\omega t$  V. Find the voltage drop across the series combination of the inductor and capacitor when (a)  $\omega = \omega_o$ ; (b)  $\omega = \omega_{c1}$ ; (c)  $\omega = \omega_{c2}$ ; (d)  $\omega = 0.1\omega_o$ ; (e)  $\omega = 10\omega_o$ .

- 14.24** Show that the alternative forms for the cutoff frequencies of a bandpass filter, given in Eqs. 14.36 and 14.37, can be derived from Eqs. 14.34 and 14.35.

- 14.25** Using a 50 nF capacitor in the bandpass circuit shown in Fig. 14.22, design a filter with a quality factor of 5 and a center frequency of 20 krad/s.

DESIGN  
PROBLEM  
PSPICE  
MULTISIM

- Specify the numerical values of  $R$  and  $L$ .
- Calculate the upper and lower cutoff frequencies in kilohertz.
- Calculate the bandwidth in hertz.

- 14.26** Design a series  $RLC$  bandpass filter using only three components from Appendix H that comes closest to meeting the filter specifications in Problem 14.25.

- Draw your filter, labeling all component values and the input and output voltages.
- Calculate the percent error in this new filter's center frequency and quality factor when compared to the values specified in Problem 14.25.

- 14.27** Use a 5 nF capacitor to design a series  $RLC$  bandpass filter, as shown at the top of Fig. 14.27. The center frequency of the filter is 8 kHz, and the quality factor is 2.

DESIGN  
PROBLEM  
PSPICE  
MULTISIM

- Specify the values of  $R$  and  $L$ .
- What is the lower cutoff frequency in kilohertz?
- What is the upper cutoff frequency in kilohertz?
- What is the bandwidth of the filter in kilohertz?

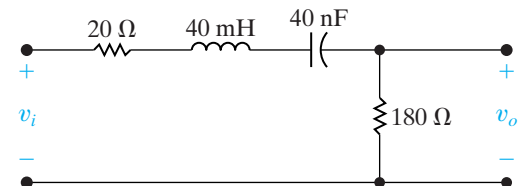
- 14.28** Design a series  $RLC$  bandpass filter using only three components from Appendix H that comes closest to meeting the filter specifications in Problem 14.27.

- Draw your filter, labeling all component values and the input and output voltages.
- Calculate the percent error in this new filter's center frequency and quality factor when compared to the values specified in Problem 14.27.

- 14.29** For the bandpass filter shown in Fig. P14.29, calculate the following: (a)  $f_o$ ; (b)  $Q$ ; (c)  $f_{c1}$ ; (d)  $f_{c2}$ ; and (e)  $\beta$ .

PSPICE  
MULTISIM

Figure P14.29



- 14.30** The input voltage in the circuit in Fig. P14.29 is  $10\cos\omega t$  V. Calculate the output voltage when (a)  $\omega = \omega_o$ ; (b)  $\omega = \omega_{c1}$ ; and (c)  $\omega = \omega_{c2}$ .

- 14.31** Consider the circuit shown in Fig. P14.31.

PSPICE  
MULTISIM

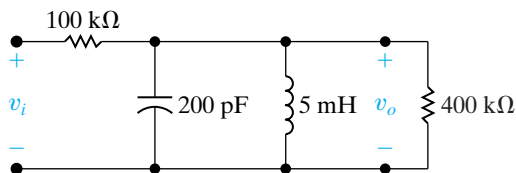
- Find  $\omega_o$ .
- Find  $\beta$ .
- Find  $Q$ .
- Find the steady-state expression for  $v_o$  when  $v_i = 250\cos\omega_o t$  mV.

- e) Show that if  $R_L$  is expressed in kilohms the  $Q$  of the circuit in Fig. P14.31 is

$$Q = \frac{20}{1 + 100/R_L}$$

- f) Plot  $Q$  versus  $R_L$  for  $20 \text{ k}\Omega \leq R_L \leq 2 \text{ M}\Omega$ .

Figure P14.31

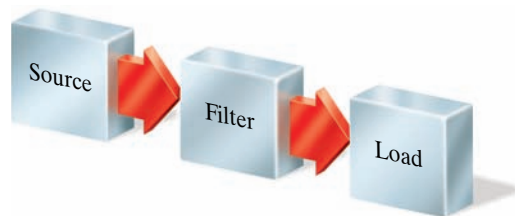


- 14.32** A block diagram of a system consisting of a sinusoidal voltage source, an  $RLC$  series bandpass filter, and a load is shown in Fig. P14.32. The internal impedance of the sinusoidal source is  $80 + j0 \Omega$ , and the impedance of the load is  $480 + j0 \Omega$ .

The  $RLC$  series bandpass filter has a  $20 \text{ nF}$  capacitor, a center frequency of  $50 \text{ krad/s}$ , and a quality factor of  $6.25$ .

- Draw a circuit diagram of the system.
- Specify the numerical values of  $L$  and  $R$  for the filter section of the system.
- What is the quality factor of the interconnected system?
- What is the bandwidth (in hertz) of the interconnected system?

Figure P14.32

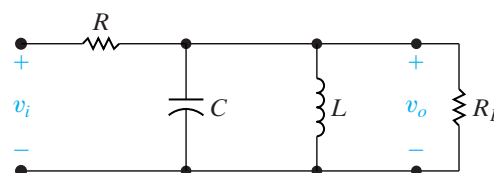


- 14.33** The purpose of this problem is to investigate how a resistive load connected across the output terminals of the bandpass filter shown in Fig. 14.19 affects the quality factor and hence the bandwidth of the filtering system. The loaded filter circuit is shown in Fig. P14.33.

- Calculate the transfer function  $V_o/V_i$  for the circuit shown in Fig. P14.33.
- What is the expression for the bandwidth of the system?
- What is the expression for the loaded bandwidth ( $\beta_L$ ) as a function of the unloaded bandwidth ( $\beta_U$ )?

- What is the expression for the quality factor of the system?
- What is the expression for the loaded quality factor ( $Q_L$ ) as a function of the unloaded quality factor ( $Q_U$ )?
- What are the expressions for the cutoff frequencies  $\omega_{c1}$  and  $\omega_{c2}$ ?

Figure P14.33

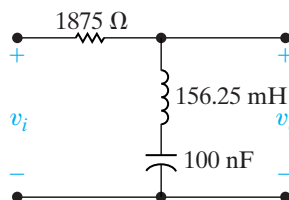


- 14.34** The parameters in the circuit in Fig. P14.33 are  $R = 2.4 \text{ k}\Omega$ ,  $C = 50 \text{ pF}$ , and  $L = 2 \mu\text{H}$ . The quality factor of the circuit is not to drop below  $7.5$ . What is the smallest permissible value of the load resistor  $R_L$ ?

### Section 14.5

- 14.35** For the bandreject filter in Fig. P14.35, calculate (a)  $\omega_o$ ; (b)  $f_o$ ; (c)  $Q$ ; (d)  $\beta$  in hertz; (e)  $\omega_{c1}$ ; (f)  $f_{c1}$ ; (g)  $\omega_{c2}$ ; and (h)  $f_{c2}$ .

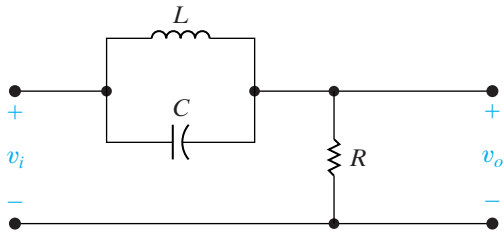
Figure P14.35



- 14.36** For the bandreject filter in Fig. P14.35,
- Find  $H(j\omega)$  at  $\omega_o$ ,  $\omega_{c1}$ ,  $\omega_{c2}$ ,  $0.1\omega_o$ , and  $10\omega_o$ .
  - If  $v_i = 80 \cos \omega t \text{ V}$ , write the steady-state expression for  $v_o$  when  $\omega = \omega_o$ ,  $\omega = \omega_{c1}$ ,  $\omega = \omega_{c2}$ ,  $\omega = 0.1\omega_o$ , and  $\omega = 10\omega_o$ .
- 14.37**
- Show (via a qualitative analysis) that the circuit in Fig. P14.37 is a bandreject filter.
  - Support the qualitative analysis of (a) by finding the voltage transfer function of the filter.
  - Derive the expression for the center frequency of the filter.
  - Derive the expressions for the cutoff frequencies  $\omega_{c1}$  and  $\omega_{c2}$ .
  - What is the expression for the bandwidth of the filter?
  - What is the expression for the quality factor of the circuit?



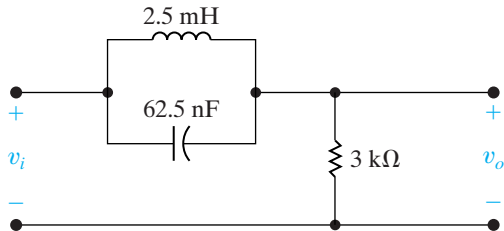
Figure P14.37



- 14.38** For the bandreject filter in Fig. P14.38, calculate (a)  $\omega_o$ ; (b)  $f_o$ ; (c)  $Q$ ; (d)  $\omega_{c1}$ ; (e)  $f_{c1}$ ; (f)  $\omega_{c2}$ ; (g)  $f_{c2}$ ; and (h)  $\beta$  in kilohertz.

PSPICE  
MULTISIM

Figure P14.38



- 14.39** Design an  $RLC$  bandreject filter (see Fig. 14.28[a]) with a quality of 2.5 and a center frequency of 25 krad/s, using a 200 nF capacitor.

- Draw your circuit, labeling the component values and output voltage.
- For the filter in part (a), calculate the bandwidth and the values of the two cutoff frequencies.

- 14.40** The input to the  $RLC$  bandreject filter designed in Problem 14.39 is  $10\cos\omega t$  V. Find the voltage drop across the series combination of the inductor and capacitor when (a)  $\omega = \omega_o$ ; (b)  $\omega = \omega_{c1}$ ; (c)  $\omega = \omega_{c2}$ ; (d)  $\omega = 0.125\omega_o$ ; (e)  $\omega = 8\omega_o$ .

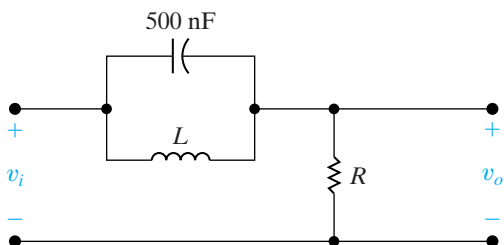
- 14.41** The input to the  $RLC$  bandreject filter designed in Problem 14.39 is  $10\cos\omega t$  V. Find the voltage drop across the resistor when (a)  $\omega = \omega_o$ ; (b)  $\omega = \omega_{c1}$ ; (c)  $\omega = \omega_{c2}$ ; (d)  $\omega = 0.125\omega_o$ ; (e)  $\omega = 8\omega_o$ .

- 14.42** Use a 500 nF capacitor to design a bandreject filter, as shown in Fig. P14.42. The filter has a center frequency of 4 kHz and a quality factor of 5.

DESIGN  
PROBLEM  
PSPICE  
MULTISIM

- Specify the numerical values of  $R$  and  $L$ .
- Calculate the upper and lower corner, or cutoff, frequencies in kilohertz.
- Calculate the filter bandwidth in kilohertz.

Figure P14.42



- 14.43** Assume the bandreject filter in Problem 14.42 is loaded with a 1 k $\Omega$  resistor.

PSPICE  
MULTISIM

- What is the quality factor of the loaded circuit?
- What is the bandwidth (in kilohertz) of the loaded circuit?
- What is the upper cutoff frequency in kilohertz?
- What is the lower cutoff frequency in kilohertz?

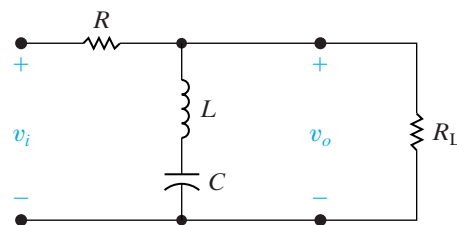
- 14.44** Design a series  $RLC$  bandreject filter using only three components from Appendix H that comes closest to meeting the filter specifications in Problem 14.42.

- Draw your filter, labeling all component values and the input and output voltages.
- Calculate the percent error in this new filter's center frequency and quality factor when compared to the values specified in Problem 14.42.

- 14.45** The purpose of this problem is to investigate how a resistive load connected across the output terminals of the bandreject filter shown in Fig. 14.28(a) affects the behavior of the filter. The loaded filter circuit is shown in Fig. P14.45.

- Find the voltage transfer function  $V_o/V_i$ .
- What is the expression for the center frequency?
- What is the expression for the bandwidth?
- What is the expression for the quality factor?
- Evaluate  $H(j\omega_o)$ .
- Evaluate  $H(j0)$ .
- Evaluate  $H(j\infty)$ .
- What are the expressions for the corner frequencies  $\omega_{c1}$  and  $\omega_{c2}$ ?

Figure P14.45



- 14.46** The parameters in the circuit in Fig. P14.45 are  $R = 30 \Omega$ ,  $L = 1 \mu\text{H}$ ,  $C = 4 \text{ pF}$ , and  $R_L = 150 \Omega$ .

PSPICE  
MULTISIM

- Find  $\omega_o$ ,  $\beta$  (in kilohertz), and  $Q$ .
- Find  $H(j0)$  and  $H(j\infty)$ .
- Find  $f_{c2}$  and  $f_{c1}$ .
- Show that if  $R_L$  is expressed in ohms the  $Q$  of the circuit is

$$Q = \frac{50}{3} [1 + (30/R_L)].$$

- Plot  $Q$  versus  $R_L$  for  $10 \Omega \leq R_L \leq 300 \Omega$ .

**14.47** The load in the bandreject filter circuit shown in Fig. P14.42 is  $500\ \Omega$ . The center frequency of the filter is  $25\ \text{krad/s}$ , and the capacitor is  $25\ \text{nF}$ . At very low and very high frequencies, the amplitude of the sinusoidal output voltage should be at least 90% of the amplitude of the sinusoidal input voltage.

PSPICE  
MULTISIM

- Specify the numerical values of  $R$  and  $L$ .
- What is the quality factor of the circuit?

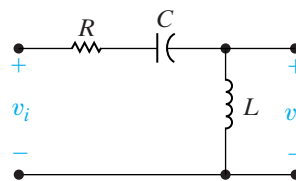
### Sections 14.1–14.5

**14.48** Given the following voltage transfer function:

$$H(s) = \frac{V_o}{V_i} = \frac{25 \times 10^6}{s^2 + 1000s + 25 \times 10^6}$$

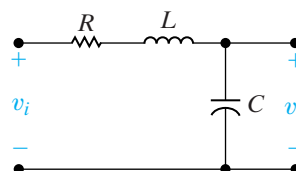
- At what frequencies (in radians per second) is the magnitude of the transfer function equal to unity?
  - At what frequency is the magnitude of the transfer function maximum?
  - What is the maximum value of the transfer function magnitude?
- 14.49** Consider the series  $RLC$  circuit shown in Fig. P14.49. When the output is the voltage across the resistor, we know this circuit is a bandpass filter. When the output is the voltage across the series combination of the inductor and capacitor, we know this circuit is a bandreject filter. This problem investigates the behavior of this circuit when the output is across the inductor.
- Find the transfer function,  $H(s) = V_o(s)/V_i(s)$  when  $V_o(s)$  is the voltage across the inductor.
  - Find the magnitude of the transfer function in part (a) for very low frequencies.
  - Find the magnitude of the transfer function in part (a) for very high frequencies.
  - Based on your answers in parts (b) and (c), what type of filter is this?
  - Suppose  $R = 600\ \Omega$ ,  $L = 400\ \text{mH}$ ,  $C = 2.5\ \mu\text{F}$ . Calculate the cutoff frequency of this filter, that is, the frequency at which the magnitude of the transfer function is  $1/\sqrt{2}$ .

Figure P14.49



- 14.50** Repeat parts (a) – (d) from Problem 14.49 for the circuit shown in Fig. P14.50. Note that the output voltage is now the voltage across the capacitor.

Figure P14.50



- 14.51** Design a series  $RLC$  bandpass filter (see Fig. 14.27) for detecting the low-frequency tone generated by pushing a telephone button as shown in Fig. 14.32.

PRACTICAL  
PERSPECTIVE  
DESIGN  
PROBLEM

- Calculate the values of  $L$  and  $C$  that place the cutoff frequencies at the edges of the DTMF low-frequency band. Note that the resistance in standard telephone circuits is always  $R = 600\ \Omega$ .
- What is the output amplitude of this circuit at each of the low-band frequencies, relative to the peak amplitude of the bandpass filter?
- What is the output amplitude of this circuit at the lowest of the high-band frequencies?

- 14.52** Design a DTMF high-band bandpass filter similar to the low-band filter design in Problem 14.51. Be sure to include the fourth high-frequency tone,  $1633\ \text{Hz}$ , in your design. What is the response amplitude of your filter to the highest of the low-frequency DTMF tones?

PRACTICAL  
PERSPECTIVE  
DESIGN  
PROBLEM

- 14.53** The  $20\ \text{Hz}$  signal that rings a telephone's bell has to have a very large amplitude to produce a loud enough bell signal. How much larger can the ringing signal amplitude be, relative to the low-band DTMF signal, so that the response of the filter in Problem 14.51 is no more than half as large as the largest of the DTMF tones?

PRACTICAL  
PERSPECTIVE  
DESIGN  
PROBLEM



# CHAPTER 15

## CHAPTER CONTENTS

- 15.1 **First-Order Low-Pass and High-Pass Filters** *p. 558*
- 15.2 **Scaling** *p. 562*
- 15.3 **Op Amp Bandpass and Bandreject Filters** *p. 564*
- 15.4 **Higher Order Op Amp Filters** *p. 571*
- 15.5 **Narrowband Bandpass and Bandreject Filters** *p. 584*

## ✓ CHAPTER OBJECTIVES

- 1 Know the op amp circuits that behave as first-order low-pass and high-pass filters and be able to calculate component values for these circuits to meet specifications of cutoff frequency and passband gain.
- 2 Be able to design filter circuits starting with a prototype circuit and use scaling to achieve desired frequency response characteristics and component values.
- 3 Understand how to use cascaded first- and second-order Butterworth filters to implement low-pass, high-pass, bandpass, and bandreject filters of any order.
- 4 Be able to use the design equations to calculate component values for prototype narrowband, bandpass, and bandreject filters to meet desired filter specifications.

# Active Filter Circuits

**Up to this point**, we have considered only passive filter circuits, that is, filter circuits consisting of resistors, inductors, and capacitors. There are areas of application, however, where active circuits, those that employ op amps, have certain advantages over passive filters. For instance, active circuits can produce bandpass and bandreject filters without using inductors. This is desirable because inductors are usually large, heavy, costly, and they may introduce electromagnetic field effects that compromise the desired frequency response characteristics.

Examine the transfer functions of all the filter circuits from Chapter 14 and you will notice that the maximum magnitude does not exceed 1. Even though passive resonant filters can achieve voltage and current amplification at the resonant frequency, passive filters in general are incapable of amplification, because the output magnitude does not exceed the input magnitude. This is not a surprising observation, as many of the transfer functions in Chapter 14 were derived using voltage or current division. Active filters provide a control over amplification not available in passive filter circuits.

Finally, recall that both the cutoff frequency and the passband magnitude of passive filters were altered with the addition of a resistive load at the output of the filter. This is not the case with active filters, due to the properties of op amps. Thus, we use active circuits to implement filter designs when gain, load variation, and physical size are important parameters in the design specifications.

In this chapter, we examine a few of the many filter circuits that employ op amps. As you will see, these op amp circuits overcome the disadvantages of passive filter circuits. Also, we will show how the basic op amp filter circuits can be combined to achieve specific frequency responses and to attain a more nearly ideal filter response. Note that throughout this chapter we assume that every op amp behaves as an ideal op amp.

## Practical Perspective

### Bass Volume Control

In this chapter, we continue to examine circuits that are frequency selective. As described in Chapter 14, this means that the behavior of the circuit depends on the frequency of its sinusoidal input. Most of the circuits presented here fall into one of the four categories identified in Chapter 14—low-pass filters, high-pass filters, bandpass filters, and bandreject filters. But whereas the circuits in Chapter 14 were constructed using sources, resistors, capacitors, and inductors, the circuits in this chapter employ op amps. We shall soon see what advantages are conferred to a filter circuit constructed using op amps.

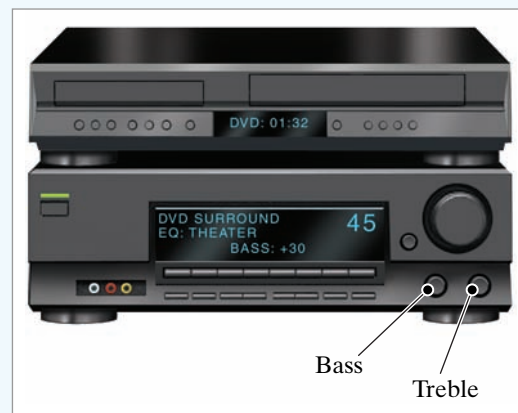
Audio electronic systems such as radios, tape players, and CD players often provide separate volume controls labeled “treble” and “bass.” These controls permit the user to select

the volume of high frequency audio signals (“treble”) independent of the volume of low frequency audio signals (“bass”). The ability to independently adjust the amount of amplification (boost) or attenuation (cut) in these two frequency bands allows a listener to customize the sound with more precision than would be provided with a single volume control. Hence the boost and cut control circuit is also referred to as a tone control circuit.

The Practical Perspective example at the end of this chapter presents a circuit that implements bass volume control using a single op amp together with resistors and capacitors. An adjustable resistor supplies the necessary control over the amplification in the bass frequency range.



Dana Hoff/Beateworks/Corbis



## 15.1 First-Order Low-Pass and High-Pass Filters

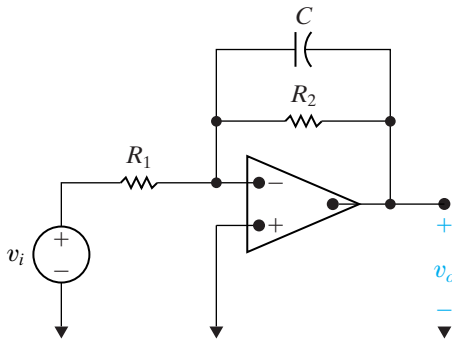


Figure 15.1 ▲ A first-order low-pass filter.

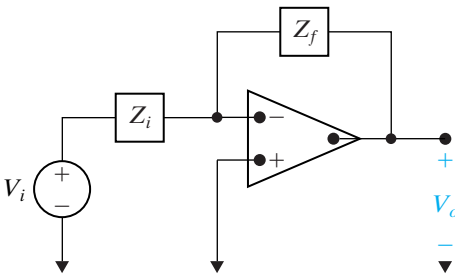


Figure 15.2 ▲ A general op amp circuit.

Consider the circuit in Fig. 15.1. Qualitatively, when the frequency of the source is varied, only the impedance of the capacitor is affected. At very low frequencies, the capacitor acts like an open circuit, and the op amp circuit acts like an amplifier with a gain of  $-R_2/R_1$ . At very high frequencies, the capacitor acts like a short circuit, thereby connecting the output of the op amp circuit to ground. The op amp circuit in Fig. 15.1 thus functions as a low-pass filter with a passband gain of  $-R_2/R_1$ .

To confirm this qualitative assessment, we can compute the transfer function  $H(s) = V_o(s)/V_i(s)$ . Note that the circuit in Fig. 15.1 has the general form of the circuit shown in Fig. 15.2, where the impedance in the input path ( $Z_i$ ) is the resistor  $R_1$ , and the impedance in the feedback path ( $Z_f$ ) is the parallel combination of the resistor  $R_2$  and the capacitor  $C$ .

The circuit in Fig. 15.2 is analogous to the inverting amplifier circuit from Chapter 5, so its transfer function is  $-Z_f/Z_i$ . Therefore, the transfer function for the circuit in Fig. 15.1 is

$$\begin{aligned} H(s) &= \frac{-Z_f}{Z_i} \\ &= \frac{-R_2 \parallel \left(\frac{1}{sC}\right)}{R_1} \\ &= -K \frac{\omega_c}{s + \omega_c}, \end{aligned} \quad (15.1)$$

where

$$K = \frac{R_2}{R_1}, \quad (15.2)$$

and

$$\omega_c = \frac{1}{R_2 C}. \quad (15.3)$$

Note that Eq. 15.1 has the same form as the general equation for low-pass filters given in Chapter 14, with an important exception: The gain in the passband,  $K$ , is set by the ratio  $R_2/R_1$ . The op amp low-pass filter thus permits the passband gain and the cutoff frequency to be specified independently.

### A Note About Frequency Response Plots

Frequency response plots, introduced in Chapter 14, provide valuable insight into the way a filter circuit functions. Thus we make extensive use of frequency response plots in this chapter, too. The frequency response plots in Chapter 14 comprised two separate plots—a plot of the transfer function magnitude versus frequency, and a plot of the transfer function phase angle, in degrees, versus frequency. When we use both plots, they are normally stacked on top of one another so that they can share the same frequency axis.

In this chapter, we use a special type of frequency response plots called **Bode plots**. Bode plots are discussed in detail in Appendix E, which includes detailed information about how to construct these plots by hand. You will probably use a computer to construct Bode plots, so here we

summarize the special features of these plots. Bode plots differ from the frequency response plots in Chapter 14 in two important ways.

First, instead of using a linear axis for the frequency values, a Bode plot uses a logarithmic axis. This permits us to plot a wider range of frequencies of interest. Normally we plot three or four decades of frequencies, say from  $10^2$  rad/s to  $10^6$  rad/s, or 1 kHz to 1 MHz, choosing the frequency range where the transfer function characteristics are changing. If we plot both the magnitude and phase angle plots, they again share the frequency axis.

Second, instead of plotting the absolute magnitude of the transfer function versus frequency, the Bode magnitude is plotted in decibels (dB) versus the log of the frequency. The decibel is discussed in Appendix D. Briefly, if the magnitude of the transfer function is  $|H(j\omega)|$ , its value in dB is given by

$$A_{\text{dB}} = 20 \log_{10}|H(j\omega)|.$$

It is important to remember that while  $|H(j\omega)|$  is an unsigned quantity,  $A_{\text{dB}}$  is a signed quantity. When  $A_{\text{dB}} = 0$ , the transfer function magnitude is 1, since  $20 \log_{10}(1) = 0$ . When  $A_{\text{dB}} < 0$ , the transfer function magnitude is between 0 and 1, and when  $A_{\text{dB}} > 0$ , the transfer function magnitude is greater than 1. Finally, note that

$$20 \log_{10}|1/\sqrt{2}| = -3 \text{ dB}.$$

Recall that we define the cutoff frequency of filters by determining the frequency at which the maximum magnitude of the transfer function has been reduced by  $1/\sqrt{2}$ . If we translate this definition to magnitude in dB, we define the cutoff frequency of a filter by determining the frequency at which the maximum magnitude of the transfer function in dB has been reduced by 3 dB. For example, if the magnitude of a low-pass filter in its passband is 26 dB, the magnitude used to find the cutoff frequency is  $26 - 3 = 23$  dB.

Example 15.1 illustrates the design of a first-order low pass filter to meet desired specifications of passband gain and cutoff frequency, and also illustrates a Bode magnitude plot of the filter's transfer function.

### Example 15.1 Designing a Low-Pass Op Amp Filter

Using the circuit shown in Fig. 15.1, calculate values for  $C$  and  $R_2$  that, together with  $R_1 = 1 \Omega$ , produce a low-pass filter having a gain of 1 in the passband and a cutoff frequency of 1 rad/s. Construct the transfer function for this filter and use it to sketch a Bode magnitude plot of the filter's frequency response.

#### Solution

Equation 15.2 gives the passband gain in terms of  $R_1$  and  $R_2$ , so it allows us to calculate the required value of  $R_2$ :

$$\begin{aligned} R_2 &= KR_1 \\ &= (1)(1) \\ &= 1 \Omega. \end{aligned}$$

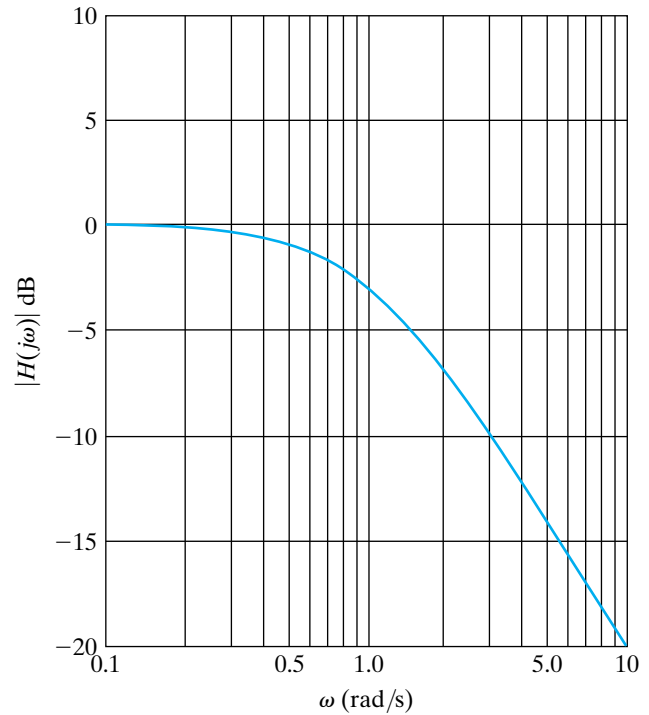
Equation 15.3 then permits us to calculate  $C$  to meet the specified cutoff frequency:

$$\begin{aligned} C &= \frac{1}{R_2\omega_c} \\ &= \frac{1}{(1)(1)} \\ &= 1 \text{ F}. \end{aligned}$$

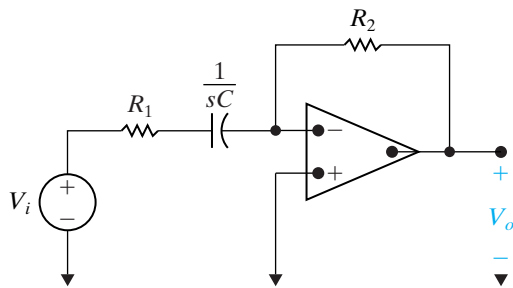
The transfer function for the low-pass filter is given by Eq. 15.1:

$$\begin{aligned} H(s) &= -K \frac{\omega_c}{s + \omega_c} \\ &= \frac{-1}{s + 1}. \end{aligned}$$

The Bode plot of  $|H(j\omega)|$  is shown in Fig. 15.3. This is the so-called **prototype** low-pass op amp filter, because it uses a resistor value of  $1 \Omega$  and a capacitor value of  $1 \text{ F}$ , and it provides a cutoff frequency of  $1 \text{ rad/s}$ . As we shall see in the next section, prototype filters provide a useful starting point for the design of filters by using more realistic component values to achieve a desired frequency response.



**Figure 15.3** ▲ The Bode magnitude plot of the low-pass filter from Example 15.1.



**Figure 15.4** ▲ A first-order high-pass filter.

You may have recognized the circuit in Fig. 15.1 as the integrating amplifier circuit introduced in Chapter 7. They are indeed the same circuit, so integration in the time domain corresponds to low-pass filtering in the frequency domain. This relationship between integration and low-pass filtering is further confirmed by the operational Laplace transform for integration derived in Chapter 12.

The circuit in Fig. 15.4 is a first-order high-pass filter. This circuit also has the general form of the circuit in Fig. 15.2, only now the impedance in the input path is the series combination of  $R_1$  and  $C$ , and the impedance in the feedback path is the resistor  $R_2$ . The transfer function for the circuit in Fig 15.4 is thus

$$\begin{aligned} H(s) &= \frac{-Z_f}{Z_i} \\ &= \frac{-R_2}{R_1 + \frac{1}{sC}} \\ &= -K \frac{s}{s + \omega_c}, \end{aligned} \tag{15.4}$$

where

$$K = \frac{R_2}{R_1}, \tag{15.5}$$

and

$$\omega_c = \frac{1}{R_1 C}. \tag{15.6}$$

Again, the form of the transfer function given in Eq. 15.4 is the same as that given in Eq. 14.20, the equation for passive high-pass filters. And again, the active filter permits the design of a passband gain greater than 1.

Example 15.2 considers the design of an active high-pass filter which must meet frequency response specifications from a Bode plot.

### Example 15.2 Designing a High-Pass Op Amp Filter

Figure 15.5 shows the Bode magnitude plot of a high-pass filter. Using the active high-pass filter circuit in Fig. 15.4, calculate values of  $R_1$  and  $R_2$  that produce the desired magnitude response. Use a  $0.1 \mu\text{F}$  capacitor. If a  $10 \text{ k}\Omega$  load resistor is added to this filter, how will the magnitude response change?

#### Solution

Begin by writing a transfer function that has the magnitude plot shown in Fig. 15.5. To do this, note that the gain in the passband is 20 dB; therefore,  $K = 10$ . Also note that the 3 dB point is 500 rad/s. Equation 15.4 is the transfer function for a high-pass filter, so the transfer function that has the magnitude response shown in Fig. 15.5 is given by

$$H(s) = \frac{-10s}{s + 500}.$$

We can compute the values of  $R_1$  and  $R_2$  needed to yield this transfer function by equating the transfer function with Eq. 15.4:

$$H(s) = \frac{-10s}{s + 500} = \frac{-(R_2/R_1)s}{s + (1/R_1C)}.$$

Equating the numerators and denominators and then simplifying, we get two equations:

$$10 = \frac{R_2}{R_1}, \quad 500 = \frac{1}{R_1C}.$$

Using the specified value of  $C$  ( $0.1 \mu\text{F}$ ), we find

$$R_1 = 20 \text{ k}\Omega, \quad R_2 = 200 \text{ k}\Omega.$$

The circuit is shown in Fig. 15.6.

Because we have made the assumption that the op amp in this high-pass filter circuit is ideal, the addition of any load resistor, regardless of its resistance, has no effect on the behavior of the op amp. Thus, the magnitude response of a high-pass filter with a load resistor is the same as that of a high-pass filter with no load resistor, which is depicted in Fig. 15.5.

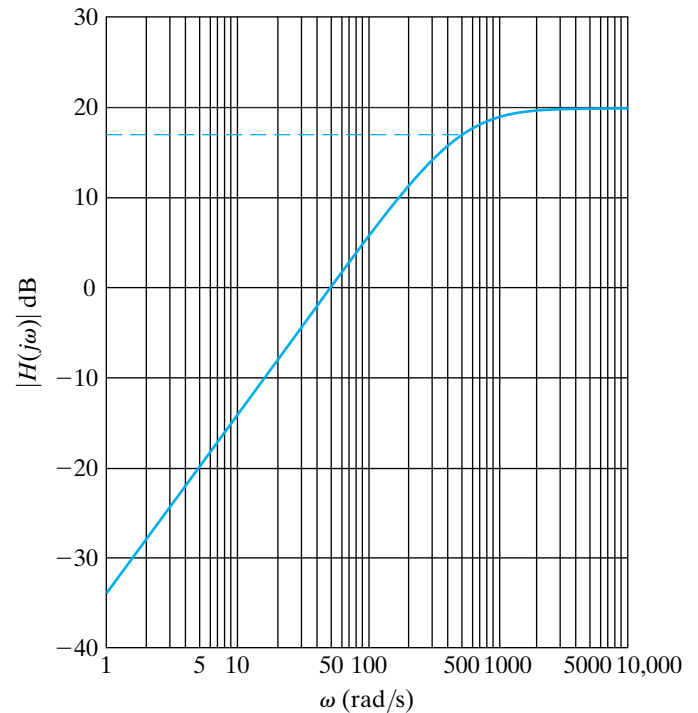


Figure 15.5 ▲ The Bode magnitude plot of the high-pass filter for Example 15.2.

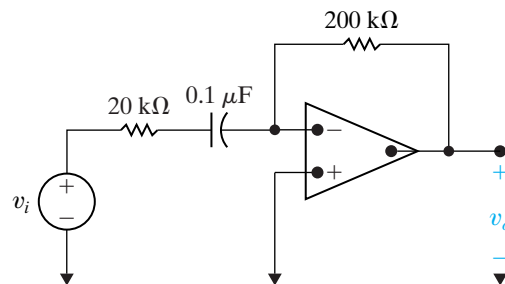


Figure 15.6 ▲ The high-pass filter for Example 15.2.

## ✓ ASSESSMENT PROBLEMS

**Objective 1**—Know the op amp circuits that behave as first order low-pass and high-pass filters and be able to calculate their component values

**15.1** Compute the values for  $R_2$  and  $C$  that yield a high-pass filter with a passband gain of 1 and a cutoff frequency of 1 rad/s if  $R_1$  is 1  $\Omega$ . (Note: This is the prototype high-pass filter.)

**Answer:**  $R_2 = 1 \Omega, C = 1 \text{ F}$ .

*NOTE:* Also try Chapter Problems 15.1 and 15.8.

**15.2** Compute the resistor values needed for the low-pass filter circuit in Fig. 15.1 to produce the transfer function

$$H(s) = \frac{-20,000}{s + 5000}.$$

Use a 5  $\mu\text{F}$  capacitor.

**Answer:**  $R_1 = 10 \Omega, R_2 = 40 \Omega$ .

## 15.2 Scaling

In the design and analysis of both passive and active filter circuits, working with element values such as 1  $\Omega$ , 1 H, and 1 F is convenient. Although these values are unrealistic for specifying practical components, they greatly simplify computations. After making computations using convenient values of  $R$ ,  $L$ , and  $C$ , the designer can transform the convenient values into realistic values using the process known as **scaling**.

There are two types of scaling: **magnitude** and **frequency**. We scale a circuit in magnitude by multiplying the impedance at a given frequency by the scale factor  $k_m$ . Thus we multiply all resistors and inductors by  $k_m$  and all capacitors by  $1/k_m$ . If we let unprimed variables represent the initial values of the parameters, and we let primed variables represent the scaled values of the variables, we have

$$R' = k_m R, \quad L' = k_m L, \quad \text{and} \quad C' = C/k_m. \quad (15.7)$$

Note that  $k_m$  is by definition a positive real number that can be either less than or greater than 1.

In frequency scaling, we change the circuit parameters so that at the new frequency, the impedance of each element is the same as it was at the original frequency. Because resistance values are assumed to be independent of frequency, resistors are unaffected by frequency scaling. If we let  $k_f$  denote the frequency scale factor, both inductors and capacitors are multiplied by  $1/k_f$ . Thus for frequency scaling,

$$R' = R, \quad L' = L/k_f, \quad \text{and} \quad C' = C/k_f. \quad (15.8)$$

The frequency scale factor  $k_f$  is also a positive real number that can be less than or greater than unity.

A circuit can be scaled simultaneously in both magnitude and frequency. The scaled values (primed) in terms of the original values (unprimed) are

**Component scale factors** ▶

$$\begin{aligned} R' &= k_m R, \\ L' &= \frac{k_m}{k_f} L, \\ C' &= \frac{1}{k_m k_f} C. \end{aligned} \quad (15.9)$$



## The Use of Scaling in the Design of Op Amp Filters

To use the concept of scaling in the design of op amp filters, first select the cutoff frequency,  $\omega_c$ , to be 1 rad/s (if you are designing low- or high-pass filters), or select the center frequency,  $\omega_o$ , to be 1 rad/s (if you are designing bandpass or bandreject filters). Then select a 1 F capacitor and calculate the values of the resistors needed to give the desired passband gain and the 1 rad/s cutoff or center frequency. Finally, use scaling to compute more realistic component values that give the desired cutoff or center frequency.

Example 15.3 illustrates the scaling process in general, and Example 15.4 illustrates the use of scaling in the design of a low-pass filter.

### Example 15.3 Scaling a Series RLC Circuit

The series RLC circuit shown in Fig. 15.7 has a center frequency of  $\sqrt{1/LC} = 1$  rad/s, a bandwidth of  $R/L = 1$  rad/s, and thus a quality factor of 1. Use scaling to compute new values of  $R$  and  $L$  that yield a circuit with the same quality factor but with a center frequency of 500 Hz. Use a  $2 \mu\text{F}$  capacitor.

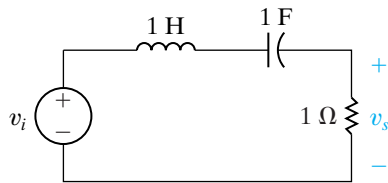


Figure 15.7 ▲ The series RLC circuit for Example 15.3.

#### Solution

Begin by computing the frequency scale factor that will shift the center frequency from 1 rad/s to 500 Hz. The unprimed variables represent values

before scaling, whereas the primed variables represent values after scaling.

$$k_f = \frac{\omega'_o}{\omega_o} = \frac{2\pi(500)}{1} = 3141.59.$$

Now, use Eq. 15.9 to compute the magnitude scale factor that, together with the frequency scale factor, will yield a capacitor value of  $2 \mu\text{F}$ :

$$k_m = \frac{1}{k_f} \frac{C}{C'} = \frac{1}{(3141.59)(2 \times 10^{-6})} = 159.155.$$

Use Eq. 15.9 again to compute the magnitude- and frequency-scaled values of  $R$  and  $L$ :

$$R' = k_m R = 159.155 \Omega,$$

$$L' = \frac{k_m}{k_f} L = 50.66 \text{ mH}.$$

With these component values, the center frequency of the series RLC circuit is  $\sqrt{1/LC} = 3141.61$  rad/s or 500 Hz, and the bandwidth is  $R/L = 3141.61$  rad/s or 500 Hz; thus the quality factor is still 1.

### Example 15.4 Scaling a Prototype Low-Pass Op Amp Filter

Use the prototype low-pass op amp filter from Example 15.1, along with magnitude and frequency scaling, to compute the resistor values for a low-pass filter with a gain of 5, a cutoff frequency of 1000 Hz, and a feedback capacitor of  $0.01 \mu\text{F}$ . Construct a Bode plot of the resulting transfer function's magnitude.

#### Solution

To begin, use frequency scaling to place the cutoff frequency at 1000 Hz:

$$k_f = \omega'_c / \omega_c = 2\pi(1000) / 1 = 6283.185,$$

where the primed variable has the new value and the unprimed variable has the old value of the cutoff frequency. Then compute the magnitude scale factor that, together with  $k_f = 6283.185$ , will scale the capacitor to  $0.01 \mu\text{F}$ :

$$k_m = \frac{1}{k_f} \frac{C}{C'} = \frac{1}{(6283.185)(10^{-8})} = 15,915.5.$$

Since resistors are scaled only by using magnitude scaling,

$$R'_1 = R'_2 = k_m R = (15,915.5)(1) = 15,915.5 \Omega.$$

Finally, we need to meet the passband gain specification. We can adjust the scaled values of either  $R_1$  or  $R_2$ , because  $K = R_2/R_1$ . If we adjust  $R_2$ , we will change the cutoff frequency, because  $\omega_c = 1/R_2C$ . Therefore, we can adjust the value of  $R_1$  to alter only the passband gain:

$$R_1 = R_2/K = (15,915.5)/(5) = 3183.1 \Omega.$$

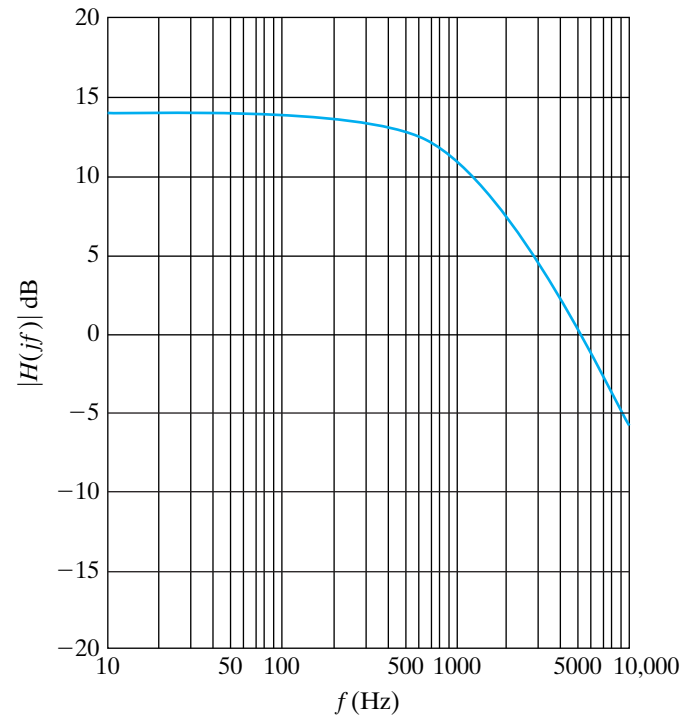
The final component values are

$$R_1 = 3183.1 \Omega, \quad R_2 = 15,915.5 \Omega, \quad C = 0.01 \mu\text{F}.$$

The transfer function of the filter is given by

$$H(s) = \frac{-31,415.93}{s + 6283.185}.$$

The Bode plot of the magnitude of this transfer function is shown in Fig. 15.8.



**Figure 15.8** ▲ The Bode magnitude plot of the low-pass filter from Example 15.4.

### ✓ ASSESSMENT PROBLEM

**Objective 2**—Be able to design filter circuits starting with a prototype and use scaling to achieve desired frequency response and component values

**15.3** What magnitude and frequency scale factors will transform the prototype high-pass filter into a high-pass filter with a  $0.5 \mu\text{F}$  capacitor and a cutoff frequency of 10 kHz?

**Answer:**  $k_f = 62,831.85$ ,  $k_m = 31.831$ .

*NOTE:* Also try Chapter Problems 15.15 and 15.16.

## 15.3 Op Amp Bandpass and Bandreject Filters

We now turn to the analysis and design of op amp circuits that act as bandpass and bandreject filters. While there is a wide variety of such op amp circuits, our initial approach is motivated by the Bode plot construction shown in Fig. 15.9. We can see from the plot that the bandpass filter consists of three separate components:

1. A unity-gain low-pass filter whose cutoff frequency is  $\omega_{c2}$ , the larger of the two cutoff frequencies;
2. A unity-gain high-pass filter whose cutoff frequency is  $\omega_{c1}$ , the smaller of the two cutoff frequencies; and
3. A gain component to provide the desired level of gain in the passband.

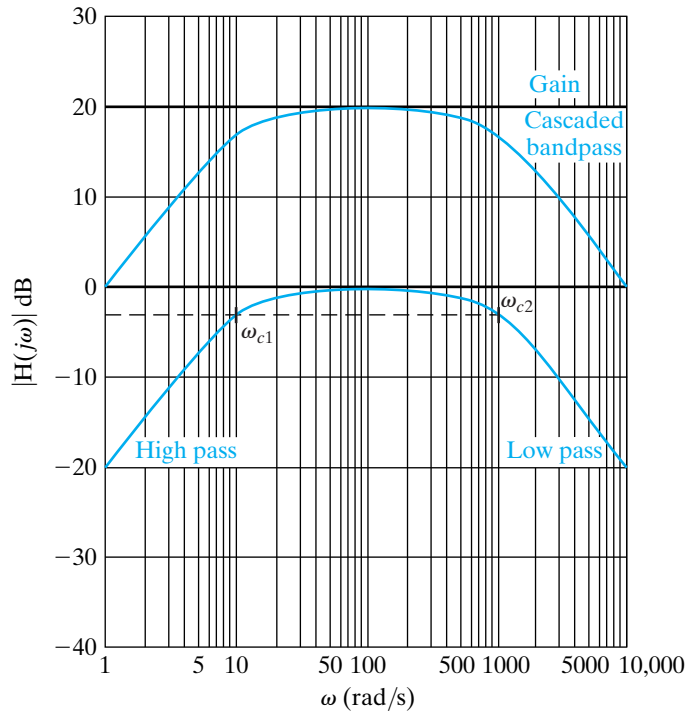


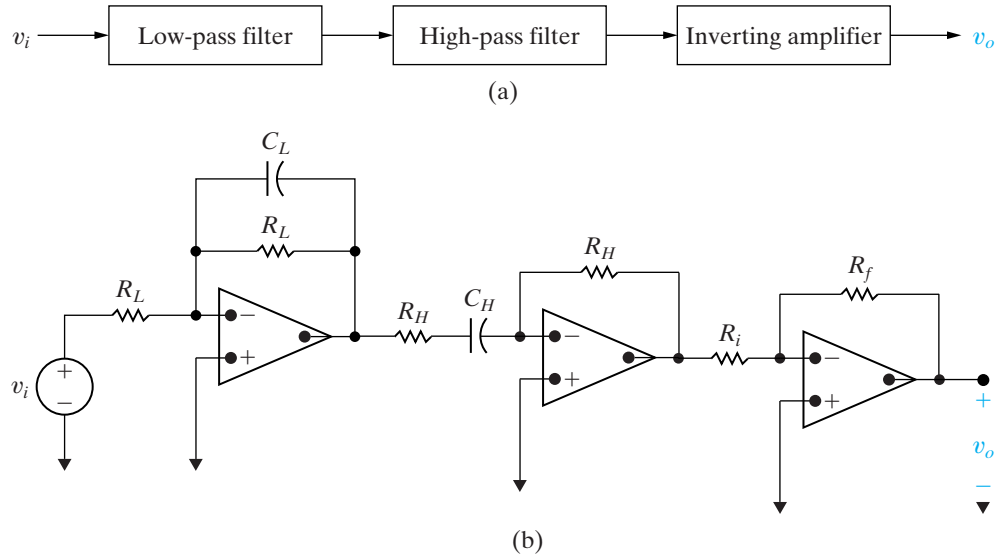
Figure 15.9 ▲ Constructing the Bode magnitude plot of a bandpass filter.

These three components are cascaded in series. They combine additively in the Bode plot construction and so will combine multiplicatively in the  $s$  domain. It is important to note that this method of constructing a bandpass magnitude response assumes that the lower cutoff frequency ( $\omega_{c1}$ ) is smaller than the upper cutoff frequency ( $\omega_{c2}$ ). The resulting filter is called a **broadband** bandpass filter, because the band of frequencies passed is wide. The formal definition of a broadband filter requires the two cutoff frequencies to satisfy the equation

$$\frac{\omega_{c2}}{\omega_{c1}} \geq 2.$$

As illustrated by the Bode plot construction in Fig. 15.9, we require the magnitude of the high-pass filter be unity at the cutoff frequency of the low-pass filter and the magnitude of the low-pass filter be unity at the cutoff frequency of the high-pass filter. Then the bandpass filter will have the cutoff frequencies specified by the low-pass and high-pass filters. We need to determine the relationship between  $\omega_{c1}$  and  $\omega_{c2}$  that will satisfy the requirements illustrated in Fig. 15.9.

We can construct a circuit that provides each of the three components by cascading a low-pass op amp filter, a high-pass op amp filter, and an inverting amplifier (see Section 5.3), as shown in Fig. 15.10(a). Figure 15.10(a) is a form of illustration called a **block diagram**. Each block represents a component or subcircuit, and the output of one block is the input to the next, in the direction indicated. We wish to establish the relationship between  $\omega_{c1}$  and  $\omega_{c2}$  that will permit each subcircuit to be designed independently, without concern for the other subcircuits in the cascade. Then the design of the bandpass filter is reduced to the design of a unity-gain first-order low-pass filter, a unity-gain first-order high-pass filter, and an inverting amplifier, each of which is a simple circuit.



**Figure 15.10** ▲ A cascaded op amp bandpass filter. (a) The block diagram. (b) The circuit.

The transfer function of the cascaded bandpass filter is the product of the transfer functions of the three cascaded components:

$$\begin{aligned}
 H(s) &= \frac{V_o}{V_i} \\
 &= \left( \frac{-\omega_{c2}}{s + \omega_{c2}} \right) \left( \frac{-s}{s + \omega_{c1}} \right) \left( \frac{-R_f}{R_i} \right) \\
 &= \frac{-K\omega_{c2}s}{(s + \omega_{c1})(s + \omega_{c2})} \\
 &= \frac{-K\omega_{c2}s}{s^2 + (\omega_{c1} + \omega_{c2})s + \omega_{c1}\omega_{c2}}. \tag{15.10}
 \end{aligned}$$

We notice right away that Eq. 15.10 is not in the standard form for the transfer function of a bandpass filter discussed in Chapter 14, namely,

$$H_{BP} = \frac{\beta s}{s^2 + \beta s + \omega_o^2}.$$

In order to convert Eq. 15.10 into the form of the standard transfer function for a bandpass filter, we require that

$$\omega_{c2} \gg \omega_{c1}. \tag{15.11}$$

When Eq. 15.11 holds,

$$(\omega_{c1} + \omega_{c2}) \approx \omega_{c2},$$

and the transfer function for the cascaded bandpass filter in Eq. 15.10 becomes

$$H(s) = \frac{-K\omega_{c2}s}{s^2 + \omega_{c2}s + \omega_{c1}\omega_{c2}}.$$

Once we confirm that Eq. 15.11 holds for the cutoff frequencies specified for the desired bandpass filter, we can design each stage of the cascaded circuit independently and meet the filter specifications. We

compute the values of  $R_L$  and  $C_L$  in the low-pass filter to give us the desired upper cutoff frequency,  $\omega_{c2}$ :

$$\omega_{c2} = \frac{1}{R_L C_L}. \quad (15.12)$$

We compute the values of  $R_H$  and  $C_H$  in the high-pass filter to give us the desired lower cutoff frequency,  $\omega_{c1}$ :

$$\omega_{c1} = \frac{1}{R_H C_H}. \quad (15.13)$$

Now we compute the values of  $R_i$  and  $R_f$  in the inverting amplifier to provide the desired passband gain. To do this, we consider the magnitude of the bandpass filter's transfer function, evaluated at the center frequency,  $\omega_o$ :

$$\begin{aligned} |H(j\omega_o)| &= \left| \frac{-K\omega_{c2}(j\omega_o)}{(j\omega_o)^2 + \omega_{c2}(j\omega_o) + \omega_{c1}\omega_{c2}} \right| \\ &= \frac{K\omega_{c2}}{\omega_{c2}} \\ &= K. \end{aligned} \quad (15.14)$$

Recall from Chapter 5 that the gain of the inverting amplifier is  $R_f/R_i$ . Therefore,

$$|H(j\omega_o)| = \frac{R_f}{R_i}. \quad (15.15)$$

Any choice of resistors that satisfies Eq. 15.15 will produce the desired passband gain.

Example 15.5 illustrates the design process for the cascaded bandpass filter.

### Example 15.5 Designing a Broadband Bandpass Op Amp Filter

Design a bandpass filter for a graphic equalizer to provide an amplification of 2 within the band of frequencies between 100 and 10,000 Hz. Use 0.2  $\mu\text{F}$  capacitors.

#### Solution

We can design each subcircuit in the cascade and meet the specified cutoff frequency values only if Eq. 15.11 holds. In this case,  $\omega_{c2} = 100\omega_{c1}$ , so we can say that  $\omega_{c2} \gg \omega_{c1}$ .

Begin with the low-pass stage. From Eq. 15.12,

$$\omega_{c2} = \frac{1}{R_L C_L} = 2\pi(10000),$$

$$R_L = \frac{1}{[2\pi(10000)](0.2 \times 10^{-6})}$$

$$\approx 80 \Omega.$$

Next, we turn to the high-pass stage. From Eq. 15.13,

$$\omega_{c1} = \frac{1}{R_H C_H} = 2\pi(100),$$

$$R_H = \frac{1}{[2\pi(100)](0.2 \times 10^{-6})}$$

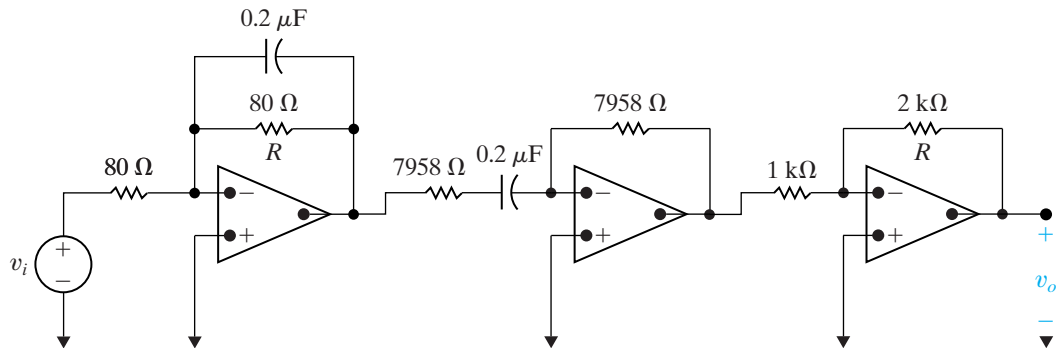
$$\approx 7958 \Omega.$$

Finally, we need the gain stage. From Eq. 15.15, we see there are two unknowns, so one of the resistors can be selected arbitrarily. Let's select a 1 k $\Omega$  resistor for  $R_i$ . Then, from Eq. 15.15,

$$R_f = 2(1000)$$

$$= 2000 \Omega = 2 \text{ k}\Omega.$$

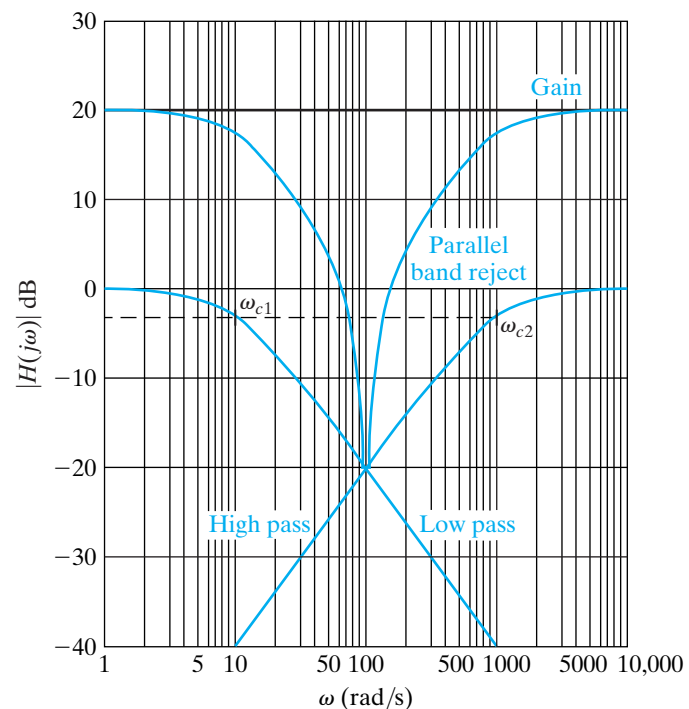
The resulting circuit is shown in Fig. 15.11. We leave to you to verify that the magnitude of this circuit's transfer function is reduced by  $1/\sqrt{2}$  at both cutoff frequencies, verifying the validity of the assumption  $\omega_{c2} \gg \omega_{c1}$ .



**Figure 15.11** ▲ The cascaded op amp bandpass filter designed in Example 15.5.

We can use a component approach to the design of op amp bandreject filters too, as illustrated in Fig. 15.12. Like the bandpass filter, the bandreject filter consists of three separate components. There are important differences, however:

1. The unity-gain low-pass filter has a cutoff frequency of  $\omega_{c1}$ , which is the smaller of the two cutoff frequencies.
2. The unity-gain high-pass filter has a cutoff frequency of  $\omega_{c2}$ , which is the larger of the two cutoff frequencies.
3. The gain component provides the desired level of gain in the passbands.



**Figure 15.12** ▲ Constructing the Bode magnitude plot of a bandreject filter.

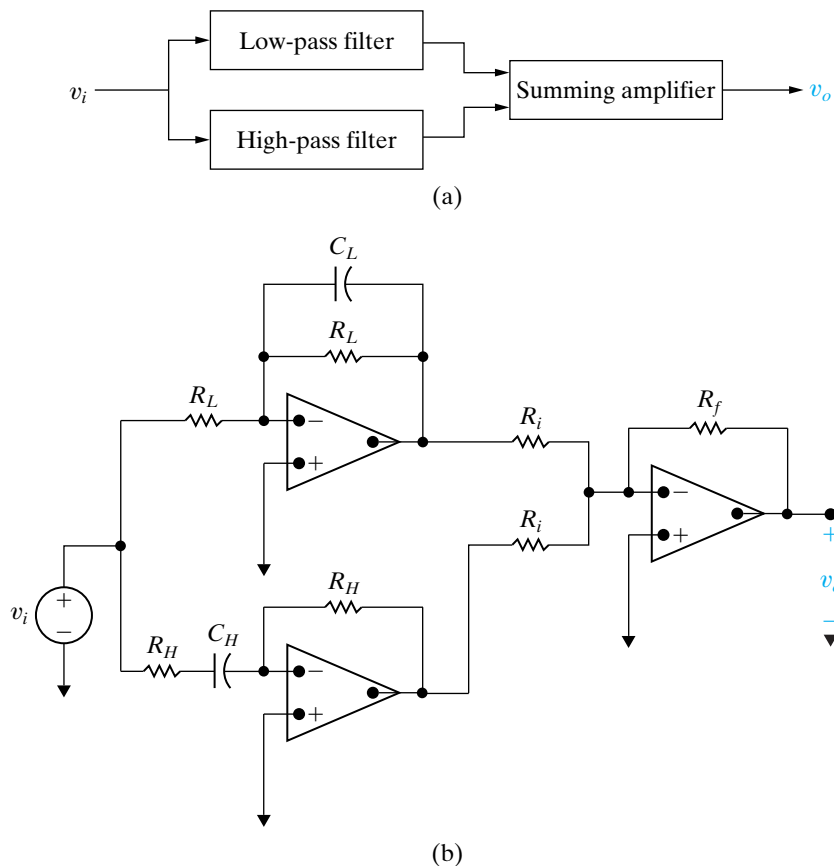
The most important difference is that these three components cannot be cascaded in series, because they do not combine additively on the Bode plot. Instead, we use a parallel connection and a summing amplifier, as shown both in block diagram form and as a circuit in Fig. 15.13. Again, it is assumed that the two cutoff frequencies are widely separated, so that the resulting design is a broadband bandreject filter, and  $\omega_{c2} \gg \omega_{c1}$ . Then each component of the parallel design can be created independently, and the cutoff frequency specifications will be satisfied. The transfer function of the resulting circuit is the sum of the low-pass and high-pass filter transfer functions. From Fig. 15.13(b),

$$\begin{aligned}
 H(s) &= \left(-\frac{R_f}{R_i}\right) \left[ \frac{-\omega_{c1}}{s + \omega_{c1}} + \frac{-s}{s + \omega_{c2}} \right] \\
 &= \frac{R_f}{R_i} \left( \frac{\omega_{c1}(s + \omega_{c2}) + s(s + \omega_{c1})}{(s + \omega_{c1})(s + \omega_{c2})} \right) \\
 &= \frac{R_f}{R_i} \left( \frac{s^2 + 2\omega_{c1}s + \omega_{c1}\omega_{c2}}{(s + \omega_{c1})(s + \omega_{c2})} \right). \tag{15.16}
 \end{aligned}$$

Using the same rationale as for the cascaded bandpass filter, the two cutoff frequencies for the transfer function in Eq. 15.16 are  $\omega_{c1}$  and  $\omega_{c2}$  only if  $\omega_{c2} \gg \omega_{c1}$ . Then the cutoff frequencies are given by the equations

$$\omega_{c1} = \frac{1}{R_L C_L}, \tag{15.17}$$

$$\omega_{c2} = \frac{1}{R_H C_H}. \tag{15.18}$$



**Figure 15.13** ▲ A parallel op amp bandreject filter. (a) The block diagram. (b) The circuit.



In the two passbands (as  $s \rightarrow 0$  and  $s \rightarrow \infty$ ), the gain of the transfer function is  $R_f/R_i$ . Therefore,

$$K = \frac{R_f}{R_i}. \quad (15.19)$$

As with the design of the cascaded bandpass filter, we have six unknowns and three equations. Typically we choose a commercially available capacitor value for  $C_L$  and  $C_H$ . Then Eqs. 15.17 and 15.18 permit us to calculate  $R_L$  and  $R_H$  to meet the specified cutoff frequencies. Finally, we choose a value for either  $R_f$  or  $R_i$  and then use Eq. 15.19 to compute the other resistance.

Note the magnitude of the transfer function in Eq. 15.16 at the center frequency,  $\omega_o = \sqrt{\omega_{c1}\omega_{c2}}$ :

$$\begin{aligned} |H(j\omega_o)| &= \left| \frac{R_f \left( \frac{(j\omega_o)^2 + 2\omega_{c1}(j\omega_o) + \omega_{c1}\omega_{c2}}{(j\omega_o)^2 + (\omega_{c1} + \omega_{c2})(j\omega_o) + \omega_{c1}\omega_{c2}} \right)}{R_i} \right| \\ &= \frac{R_f}{R_i} \frac{2\omega_{c1}}{\omega_{c1} + \omega_{c2}} \\ &\approx \frac{R_f}{R_i} \frac{2\omega_{c1}}{\omega_{c2}}. \end{aligned} \quad (15.20)$$

If  $\omega_{c2} \gg \omega_{c1}$ , then  $|H(j\omega_o)| \ll 2R_f/R_i$  (as  $\omega_{c1}/\omega_{c2} \ll 1$ ), so the magnitude at the center frequency is much smaller than the passband magnitude. Thus the bandreject filter successfully rejects frequencies near the center frequency, again confirming our assumption that the parallel implementation is meant for broadband bandreject designs.

Example 15.6 illustrates the design process for the parallel bandreject filter.

### Example 15.6 Designing a Broadband Bandreject Op Amp Filter

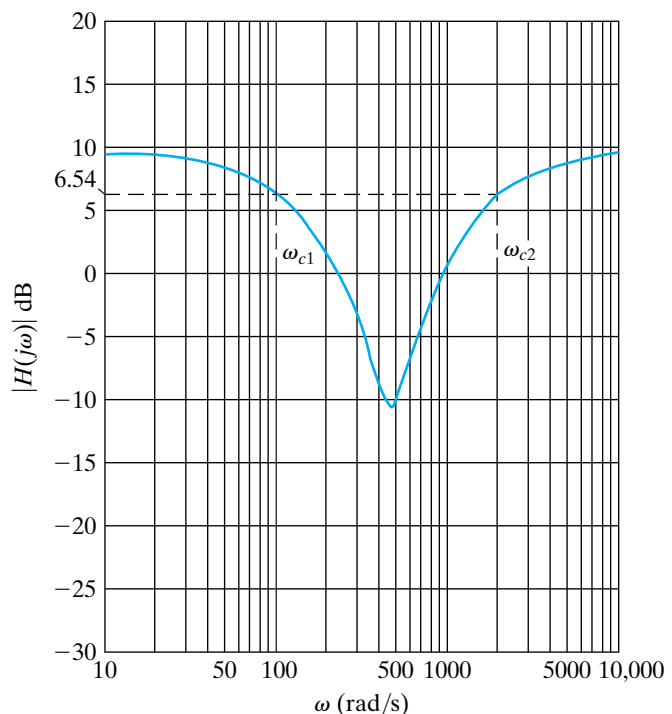
Design a circuit based on the parallel bandreject op amp filter in Fig. 15.13(b). The Bode magnitude response of this filter is shown in Fig. 15.14. Use  $0.5 \mu\text{F}$  capacitors in your design.

#### Solution

From the Bode magnitude plot in Fig. 15.14, we see that the bandreject filter has cutoff frequencies of 100 rad/s and 2000 rad/s and a gain of 3 in the passbands. Thus,  $\omega_{c2} = 20\omega_{c1}$ , so we make the assumption that  $\omega_{c2} \gg \omega_{c1}$ . Begin with the prototype low-pass filter and use scaling to meet the specifications for cutoff frequency and capacitor value. The frequency scale factor  $k_f$  is 100, which shifts the cutoff frequency from 1 rad/s to 100 rad/s. The magnitude scale factor  $k_m$  is 20,000, which permits the use of a  $0.5 \mu\text{F}$  capacitor. Using these scale factors results in the following scaled component values:

$$R_L = 20 \text{ k}\Omega,$$

$$C_L = 0.5 \mu\text{F}.$$



**Figure 15.14** ▲ The Bode magnitude plot for the circuit to be designed in Example 15.6.

The resulting cutoff frequency of the low-pass filter component is

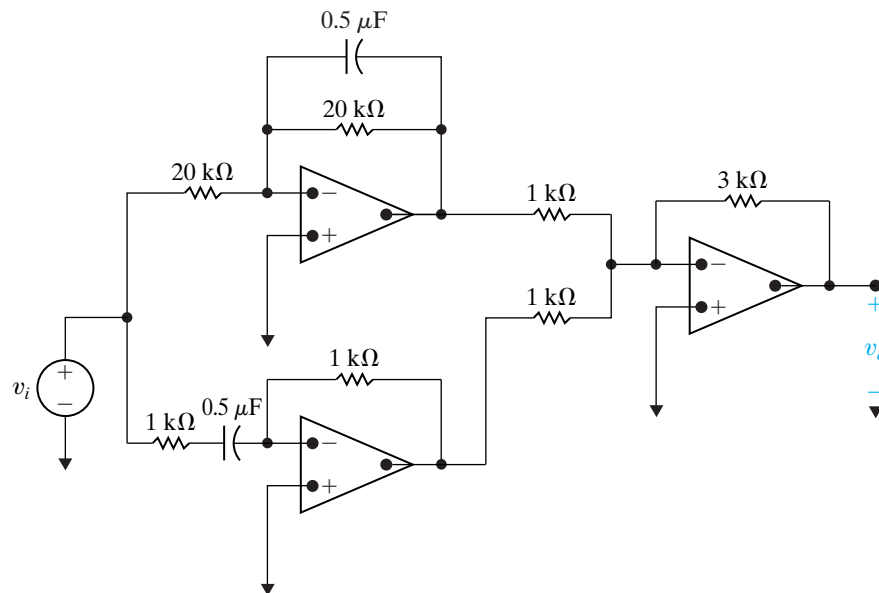
$$\begin{aligned}\omega_{c1} &= \frac{1}{R_L C_L} \\ &= \frac{1}{(20 \times 10^3)(0.5 \times 10^{-6})} \\ &= 100 \text{ rad/s.}\end{aligned}$$

We use the same approach to design the high-pass filter, starting with the prototype high-pass op amp filter. Here, the frequency scale factor is  $k_f = 2000$ , and the magnitude scale factor is  $k_m = 1000$ , resulting in the following scaled component values:

$$\begin{aligned}R_H &= 1 \text{ k}\Omega, \\ C_H &= 0.5 \text{ }\mu\text{F}.\end{aligned}$$

Finally, because the cutoff frequencies are widely separated, we can use the ratio  $R_f/R_i$  to establish the desired passband gain of 3. Let's choose  $R_i = 1 \text{ k}\Omega$ , as we are already using that resistance for  $R_H$ . Then  $R_f = 3 \text{ k}\Omega$ , and  $K = R_f/R_i = 3000/1000 = 3$ . The resulting parallel op amp band-reject filter circuit is shown in Fig. 15.15.

Now let's check our assumption that  $\omega_{c2} \gg \omega_{c1}$  by calculating the actual gain at the specified cutoff frequencies. We do this by making the substitutions  $s = j2\pi(100)$  and  $s = j2\pi(2000)$  into the transfer function for the parallel bandreject filter, Eq. 15.16 and calculating the resulting magnitude. We leave it to the reader to verify that the magnitude at the specified cutoff frequencies is 2.024, which is less than the magnitude of  $3/\sqrt{2} = 2.12$  that we expect. Therefore, our rejecting band is somewhat wider than specified in the problem statement.



**Figure 15.15** ▲ The resulting bandreject filter circuit designed in Example 15.6.

*NOTE:* Assess your understanding of this material by trying Chapter Problems 15.30 and 15.31.

## 15.4 Higher Order Op Amp Filters

You have probably noticed that all of the filter circuits we have examined so far, both passive and active, are nonideal. Remember from Chapter 14 that an ideal filter has a discontinuity at the point of cutoff, which sharply divides the passband and the stopband. Although we cannot hope to construct a circuit with a discontinuous frequency response, we can construct circuits with a sharper, yet still continuous, transition at the cutoff frequency.

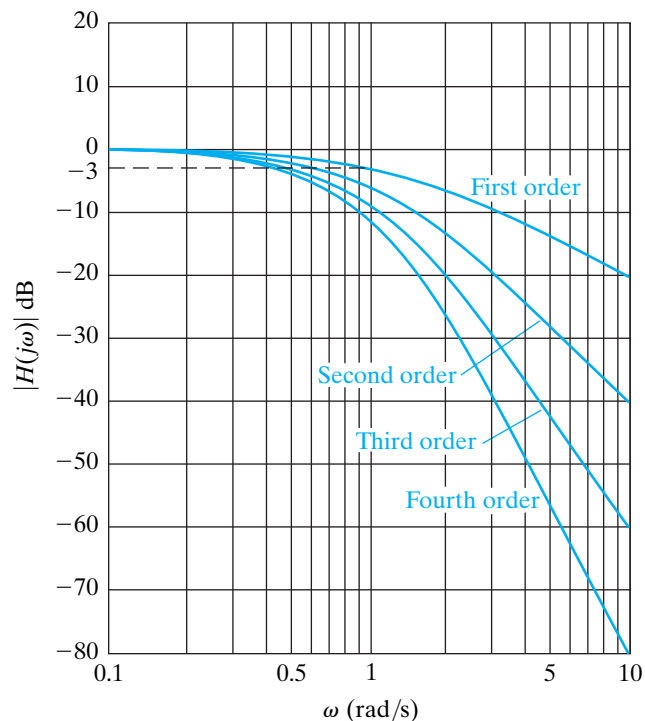
## Cascading Identical Filters

How can we obtain a sharper transition between the passband and the stopband? One approach is suggested by the Bode magnitude plots in Fig. 15.16. This figure shows the Bode magnitude plots of a cascade of identical prototype low-pass filters and includes plots of just one filter, two in cascade, three in cascade, and four in cascade. It is obvious that as more filters are added to the cascade, the transition from the passband to the stopband becomes sharper. The rules for constructing Bode plots (from Appendix E) tell us that with one filter, the transition occurs with an asymptotic slope of 20 decibels per decade (dB/dec). Because circuits in cascade are additive on a Bode magnitude plot, a cascade with two filters has a transition with an asymptotic slope of  $20 + 20 = 40$  dB/dec; for three filters, the asymptotic slope is 60 dB/dec, and for four filters, it is 80 dB/dec, as seen in Fig. 15.16.

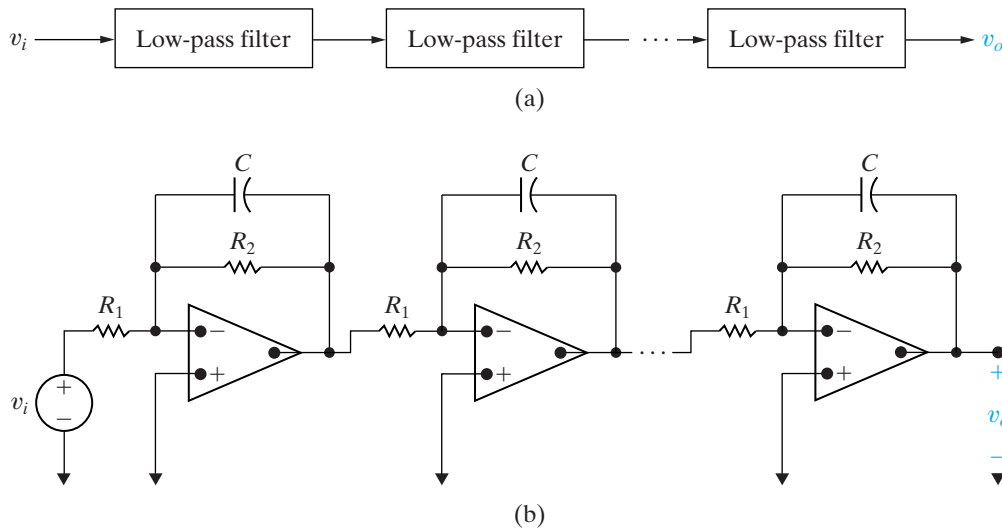
In general, an  $n$ -element cascade of identical low-pass filters will transition from the passband to the stopband with a slope of  $20n$  dB/dec. Both the block diagram and the circuit diagram for such a cascade are shown in Fig. 15.17. It is easy to compute the transfer function for a cascade of  $n$  prototype low-pass filters—we just multiply the individual transfer functions:

$$\begin{aligned} H(s) &= \left(\frac{-1}{s+1}\right)\left(\frac{-1}{s+1}\right)\cdots\left(\frac{-1}{s+1}\right) \\ &= \frac{(-1)^n}{(s+1)^n}. \end{aligned} \quad (15.21)$$

The order of a filter is determined by the number of poles in its transfer function. From Eq. 15.21, we see that a cascade of first-order low-pass filters yields a higher order filter. In fact, a cascade of  $n$  first-order filters produces an  $n$ th-order filter, having  $n$  poles in its transfer function and a final slope of  $20n$  dB/dec in the transition band.



**Figure 15.16** ▲ The Bode magnitude plot of a cascade of identical prototype first-order filters.



**Figure 15.17** ▲ A cascade of identical unity-gain low-pass filters. (a) The block diagram. (b) The circuit.

There is an important issue yet to be resolved, as you will see if you look closely at Fig. 15.16. As the order of the low-pass filter is increased by adding prototype low-pass filters to the cascade, the cutoff frequency also changes. For example, in a cascade of two first-order low-pass filters, the magnitude of the resulting second-order filter at  $\omega_c$  is  $-6$  dB, so the cutoff frequency of the second-order filter is not  $\omega_c$ . In fact, the cutoff frequency is less than  $\omega_c$ .

As long as we are able to calculate the cutoff frequency of the higher order filters formed in the cascade of first-order filters, we can use frequency scaling to calculate component values that move the cutoff frequency to its specified location. If we start with a cascade of  $n$  prototype low-pass filters, we can compute the cutoff frequency for the resulting  $n$ th-order low-pass filter. We do so by solving for the value of  $\omega_{cn}$  that results in  $|H(j\omega)| = 1/\sqrt{2}$ :

$$\begin{aligned}
 H(s) &= \frac{(-1)^n}{(s+1)^n}, \\
 |H(j\omega_{cn})| &= \left| \frac{1}{(j\omega_{cn}+1)^n} \right| = \frac{1}{\sqrt{2}}, \\
 \frac{1}{(\sqrt{\omega_{cn}^2+1})^n} &= \frac{1}{\sqrt{2}}, \\
 \frac{1}{\omega_{cn}^2+1} &= \left( \frac{1}{\sqrt{2}} \right)^{2/n}, \\
 \sqrt[n]{2} &= \omega_{cn}^2+1, \\
 \omega_{cn} &= \sqrt{\sqrt[n]{2}-1}. \tag{15.22}
 \end{aligned}$$

To demonstrate the use of Eq. 15.22, let's compute the cutoff frequency of a fourth-order unity-gain low-pass filter constructed from a cascade of four prototype low-pass filters:

$$\omega_{c4} = \sqrt{\sqrt[4]{2}-1} = 0.435 \text{ rad/s}. \tag{15.23}$$

Thus, we can design a fourth-order low-pass filter with any arbitrary cutoff frequency by starting with a fourth-order cascade consisting of prototype low-pass filters and then scaling the components by  $k_f = \omega_c/0.435$  to place the cutoff frequency at any value of  $\omega_c$  desired.

Note that we can build a higher order low-pass filter with a nonunity gain by adding an inverting amplifier circuit to the cascade. Example 15.7 illustrates the design of a fourth-order low-pass filter with nonunity gain.

### Example 15.7 Designing a Fourth-Order Low-Pass Op Amp Filter

Design a fourth-order low-pass filter with a cutoff frequency of 500 Hz and a passband gain of 10. Use  $1\ \mu\text{F}$  capacitors. Sketch the Bode magnitude plot for this filter.

#### Solution

We begin our design with a cascade of four prototype low-pass filters. We have already used Eq. 15.23 to calculate the cutoff frequency for the resulting fourth-order low-pass filter as  $0.435\ \text{rad/s}$ . A frequency scale factor of  $k_f = 7222.39$  will scale the component values to give a 500 Hz cutoff frequency. A magnitude scale factor of  $k_m = 138.46$  permits the use of  $1\ \mu\text{F}$  capacitors. The scaled component values are thus

$$R = 138.46\ \Omega; \quad C = 1\ \mu\text{F}.$$

Finally, add an inverting amplifier stage with a gain of  $R_f/R_i = 10$ . As usual, we can arbitrarily select one of the two resistor values. Because we are already using  $138.46\ \Omega$  resistors, let  $R_i = 138.46\ \Omega$ ; then,

$$R_f = 10R_i = 1384.6\ \Omega.$$

The circuit for this cascaded the fourth-order low-pass filter is shown in Fig. 15.18. It has the transfer function

$$H(s) = -10 \left[ \frac{7222.39}{s + 7222.39} \right]^4.$$

The Bode magnitude plot for this transfer function is sketched in Fig. 15.19.

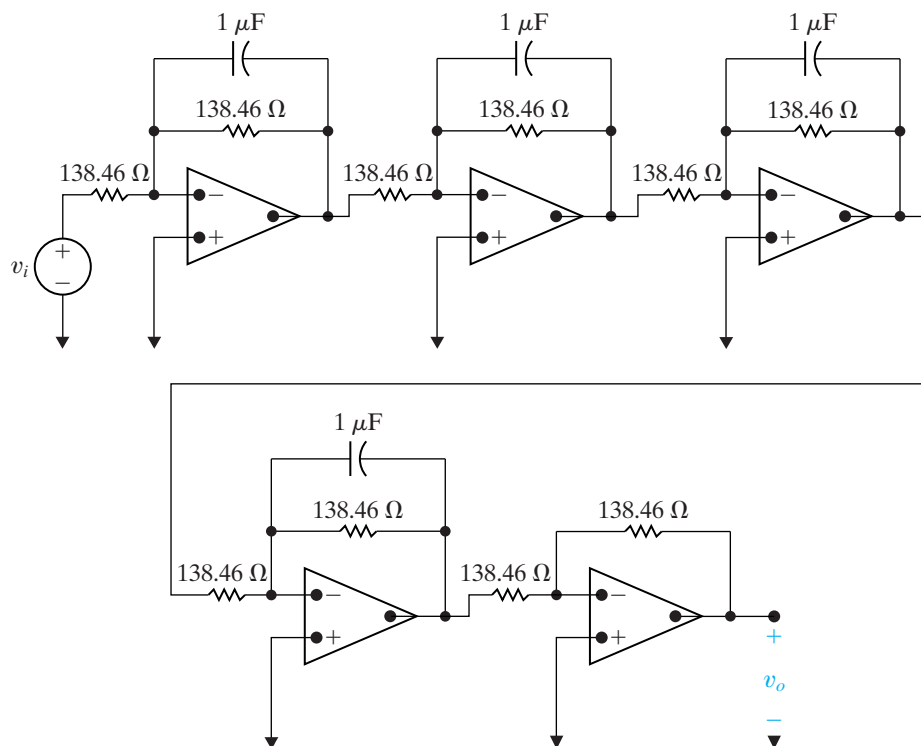
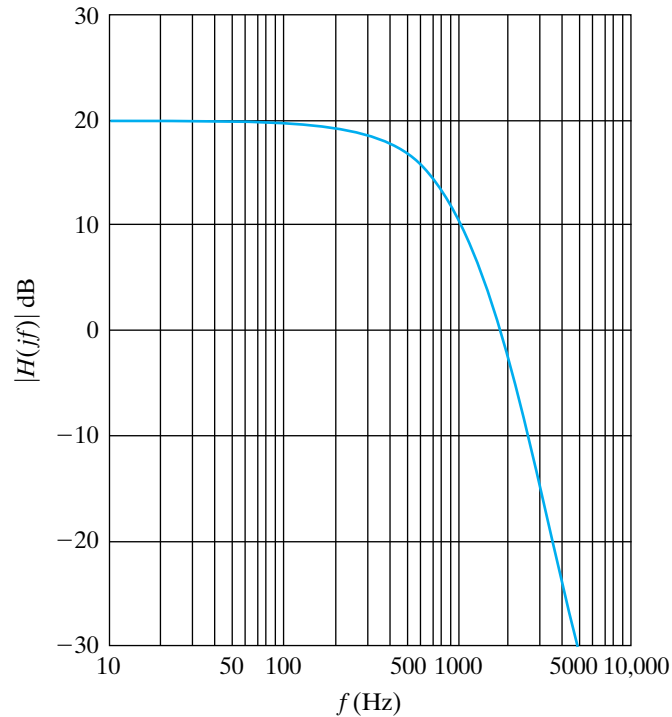


Figure 15.18 ▲ The cascade circuit for the fourth-order low-pass filter designed in Example 15.7.



**Figure 15.19** ▲ The Bode magnitude plot for the fourth-order low-pass filter designed in Example 15.7.

By cascading identical low-pass filters, we can increase the asymptotic slope in the transition and control the location of the cutoff frequency, but our approach has a serious shortcoming: The gain of the filter is not constant between zero and the cutoff frequency  $\omega_c$ . Remember that in an ideal low-pass filter, the passband magnitude is 1 for all frequencies below the cutoff frequency. But in Fig. 15.16, we see that the magnitude is less than 1 (0 dB) for frequencies much less than the cutoff frequency.

This nonideal passband behavior is best understood by looking at the magnitude of the transfer function for a unity-gain low-pass  $n$ th-order cascade. Because

$$H(s) = \frac{\omega_{cn}^n}{(s + \omega_{cn})^n},$$

the magnitude is given by

$$\begin{aligned} |H(j\omega)| &= \frac{\omega_{cn}^n}{\left(\sqrt{\omega^2 + \omega_{cn}^2}\right)^n} \\ &= \frac{1}{\left(\sqrt{(\omega/\omega_{cn})^2 + 1}\right)^n}. \end{aligned} \quad (15.24)$$

As we can see from Eq. 15.24, when  $\omega \ll \omega_{cn}$ , the denominator is approximately 1, and the magnitude of the transfer function is also nearly 1. But as  $\omega \rightarrow \omega_{cn}$ , the denominator becomes larger than 1, so the magnitude becomes smaller than 1. Because the cascade of low-pass filters results in this nonideal behavior in the passband, other approaches are taken in the design of higher order filters. One such approach is examined next.

## Butterworth Filters

A unity-gain **Butterworth low-pass filter** has a transfer function whose magnitude is given by

$$|H(j\omega)| = \frac{1}{\sqrt{1 + (\omega/\omega_c)^{2n}}}, \quad (15.25)$$

where  $n$  is an integer that denotes the order of the filter.<sup>1</sup>

When studying Eq. 15.25, note the following:

1. The cutoff frequency is  $\omega_c$  rad/s for all values of  $n$ .
2. If  $n$  is large enough, the denominator is always close to unity when  $\omega < \omega_c$ .
3. In the expression for  $|H(j\omega)|$ , the exponent of  $\omega/\omega_c$  is always even.

This last observation is important, because an even exponent is required for a physically realizable circuit (see Problem 15.26).

Given an equation for the magnitude of the transfer function, how do we find  $H(s)$ ? The derivation for  $H(s)$  is greatly simplified by using a prototype filter. Therefore, we set  $\omega_c$  equal to 1 rad/s in Eq. 15.25. As before, we will use scaling to transform the prototype filter to a filter that meets the given filtering specifications.

To find  $H(s)$ , first note that if  $N$  is a complex quantity, then  $|N|^2 = NN^*$ , where  $N^*$  is the conjugate of  $N$ . It follows that

$$|H(j\omega)|^2 = H(j\omega)H(-j\omega). \quad (15.26)$$

But because  $s = j\omega$ , we can write

$$|H(j\omega)|^2 = H(s)H(-s). \quad (15.27)$$

Now observe that  $s^2 = -\omega^2$ . Thus,

$$\begin{aligned} |H(j\omega)|^2 &= \frac{1}{1 + \omega^{2n}} \\ &= \frac{1}{1 + (\omega^2)^n} \\ &= \frac{1}{1 + (-s^2)^n} \\ &= \frac{1}{1 + (-1)^n s^{2n}}, \end{aligned}$$

or

$$H(s)H(-s) = \frac{1}{1 + (-1)^n s^{2n}}. \quad (15.28)$$

The procedure for finding  $H(s)$  for a given value of  $n$  is as follows:

1. Find the roots of the polynomial

$$1 + (-1)^n s^{2n} = 0.$$

2. Assign the left-half plane roots to  $H(s)$  and the right-half plane roots to  $H(-s)$ .
3. Combine terms in the denominator of  $H(s)$  to form first- and second-order factors.

Example 15.8 illustrates this process.

<sup>1</sup> This filter was developed by the British engineer S. Butterworth and reported in *Wireless Engineering* 7 (1930): 536–541.



**Example 15.8** Calculating Butterworth Transfer Functions

Find the Butterworth transfer functions for  $n = 2$  and  $n = 3$ .

**Solution**

For  $n = 2$ , we find the roots of the polynomial

$$1 + (-1)^2 s^4 = 0.$$

Rearranging terms, we find

$$s^4 = -1 = 1/\underline{180^\circ}.$$

Therefore, the four roots are

$$s_1 = 1/\underline{45^\circ} = 1/\sqrt{2} + j/\sqrt{2},$$

$$s_2 = 1/\underline{135^\circ} = -1/\sqrt{2} + j/\sqrt{2},$$

$$s_3 = 1/\underline{225^\circ} = -1/\sqrt{2} - j/\sqrt{2},$$

$$s_4 = 1/\underline{315^\circ} = 1/\sqrt{2} - j/\sqrt{2}.$$

Roots  $s_2$  and  $s_3$  are in the left-half plane. Thus,

$$\begin{aligned} H(s) &= \frac{1}{(s + 1/\sqrt{2} - j/\sqrt{2})(s + 1/\sqrt{2} + j/\sqrt{2})} \\ &= \frac{1}{(s^2 + \sqrt{2}s + 1)}. \end{aligned}$$

For  $n = 3$ , we find the roots of the polynomial

$$1 + (-1)^3 s^6 = 0.$$

Rearranging terms,

$$s^6 = 1/\underline{0^\circ} = 1/\underline{360^\circ}.$$

Therefore, the six roots are

$$s_1 = 1/\underline{0^\circ} = 1,$$

$$s_2 = 1/\underline{60^\circ} = 1/2 + j\sqrt{3}/2,$$

$$s_3 = 1/\underline{120^\circ} = -1/2 + j\sqrt{3}/2,$$

$$s_4 = 1/\underline{180^\circ} = -1 + j0,$$

$$s_5 = 1/\underline{240^\circ} = -1/2 - j\sqrt{3}/2,$$

$$s_6 = 1/\underline{300^\circ} = 1/2 - j\sqrt{3}/2.$$

Roots  $s_3$ ,  $s_4$ , and  $s_5$  are in the left-half plane. Thus,

$$\begin{aligned} H(s) &= \frac{1}{(s + 1)(s + 1/2 - j\sqrt{3}/2)(s + 1/2 + j\sqrt{3}/2)} \\ &= \frac{1}{(s + 1)(s^2 + s + 1)}. \end{aligned}$$

We note in passing that the roots of the Butterworth polynomial are always equally spaced around the unit circle in the  $s$  plane. To assist in the design of Butterworth filters, Table 15.1 lists the Butterworth polynomials up to  $n = 8$ .

**TABLE 15.1** Normalized (so that  $\omega_c = 1$  rad/s) Butterworth Polynomials up to the Eighth Order

$n$	$n$ th-Order Butterworth Polynomial
1	$(s + 1)$
2	$(s^2 + \sqrt{2}s + 1)$
3	$(s + 1)(s^2 + s + 1)$
4	$(s^2 + 0.765s + 1)(s^2 + 1.848s + 1)$
5	$(s + 1)(s^2 + 0.618s + 1)(s^2 + 1.618s + 1)$
6	$(s^2 + 0.518s + 1)(s^2 + \sqrt{2} + 1)(s^2 + 1.932s + 1)$
7	$(s + 1)(s^2 + 0.445s + 1)(s^2 + 1.247s + 1)(s^2 + 1.802s + 1)$
8	$(s^2 + 0.390s + 1)(s^2 + 1.111s + 1)(s^2 + 1.6663s + 1)(s^2 + 1.962s + 1)$

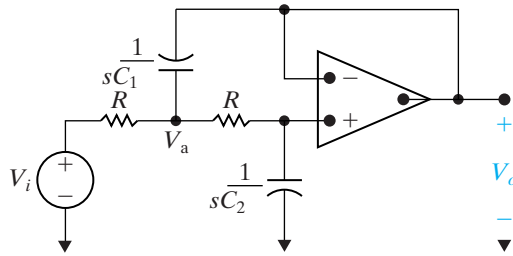
**Butterworth Filter Circuits**

Now that we know how to specify the transfer function for a Butterworth filter circuit (either by calculating the poles of the transfer function directly or by using Table 15.1), we turn to the problem of designing a circuit with

such a transfer function. Notice the form of the Butterworth polynomials in Table 15.1. They are the product of first- and second-order factors; therefore, we can construct a circuit whose transfer function has a Butterworth polynomial in its denominator by cascading op amp circuits, each of which provides one of the needed factors. A block diagram of such a cascade is shown in Fig. 15.20, using a fifth-order Butterworth polynomial as an example.

All odd-order Butterworth polynomials include the factor  $(s + 1)$ , so all odd-order Butterworth filter circuits must have a subcircuit that provides the transfer function  $H(s) = 1/(s + 1)$ . This is the transfer function of the prototype low-pass op amp filter from Fig. 15.1. So what remains is to find a circuit that provides a transfer function of the form  $H(s) = 1/(s^2 + b_1s + 1)$ .

Such a circuit is shown in Fig. 15.21. The analysis of this circuit begins by writing the  $s$ -domain nodal equations at the noninverting terminal of the op amp and at the node labeled  $V_a$ :



**Figure 15.21** ▲ A circuit that provides the second-order transfer function for the Butterworth filter cascade.

$$\frac{V_a - V_i}{R} + (V_a - V_o)sC_1 + \frac{V_a - V_o}{R} = 0, \tag{15.29}$$

$$V_o sC_2 + \frac{V_o - V_a}{R} = 0. \tag{15.30}$$

Simplifying Eqs. 15.29 and 15.30 yields

$$(2 + RC_1s)V_a - (1 + RC_1s)V_o = V_i, \tag{15.31}$$

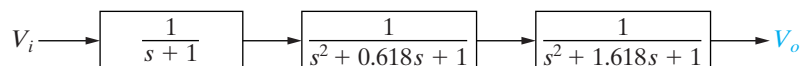
$$-V_a + (1 + RC_2s)V_o = 0. \tag{15.32}$$

Using Cramer’s rule with Eqs. 15.31 and 15.32, we solve for  $V_o$ :

$$\begin{aligned} V_o &= \frac{\begin{vmatrix} 2+RC_1s & V_i \\ -1 & 0 \end{vmatrix}}{\begin{vmatrix} 2+RC_1s & -(1+RC_1s) \\ -1 & 1+RC_2s \end{vmatrix}} \\ &= \frac{V_i}{R^2C_1C_2s^2 + 2RC_2s + 1}. \end{aligned} \tag{15.33}$$

Then, rearrange Eq. 15.33 to write the transfer function for the circuit in Fig. 15.21:

$$H(s) = \frac{V_o}{V_i} = \frac{1}{s^2 + \frac{2}{RC_1}s + \frac{1}{R^2C_1C_2}}. \tag{15.34}$$



**Figure 15.20** ▲ A cascade of first- and second-order circuits with the indicated transfer functions yielding a fifth-order low-pass Butterworth filter with  $\omega_c = 1$  rad/s.

Finally, set  $R = 1 \Omega$  in Eq. 15.34; then

$$H(s) = \frac{1}{s^2 + \frac{2}{C_1}s + \frac{1}{C_1C_2}}. \quad (15.35)$$

Note that Eq. 15.35 has the form required for the second-order circuit in the Butterworth cascade. In other words, to get a transfer function of the form

$$H(s) = \frac{1}{s^2 + b_1s + 1},$$

we use the circuit in Fig. 15.21 and choose capacitor values so that

$$b_1 = \frac{2}{C_1} \quad \text{and} \quad 1 = \frac{1}{C_1C_2}. \quad (15.36)$$

We have thus outlined the procedure for designing an  $n$ th-order Butterworth low-pass filter circuit with a cutoff frequency of  $\omega_c = 1 \text{ rad/s}$  and a gain of 1 in the passband. We can use frequency scaling to calculate revised capacitor values that yield any other cutoff frequency, and we can use magnitude scaling to provide more realistic or practical component values in our design. We can cascade an inverting amplifier circuit to provide a gain other than 1 in the passband.

Example 15.9 illustrates this design process.

### Example 15.9 Designing a Fourth-Order Low-Pass Butterworth Filter

Design a fourth-order Butterworth low-pass filter with a cutoff frequency of 500 Hz and a passband gain of 10. Use as many 1 k $\Omega$  resistors as possible. Compare the Bode magnitude plot for this Butterworth filter with that of the identical cascade filter in Example 15.7.

#### Solution

From Table 15.1, we find that the fourth-order Butterworth polynomial is

$$(s^2 + 0.765s + 1)(s^2 + 1.848s + 1).$$

We will thus need a cascade of two second-order filters to yield the fourth-order transfer function plus an inverting amplifier circuit for the passband gain of 10. The circuit is shown in Fig. 15.22.

Let the first stage of the cascade implement the transfer function for the polynomial  $(s^2 + 0.765s + 1)$ . From Eq. 15.36,

$$C_1 = 2.61 \text{ F},$$

$$C_2 = 0.38 \text{ F}.$$

Let the second stage of the cascade implement the transfer function for the polynomial  $(s^2 + 1.848s + 1)$ . From Eq. 15.36,

$$C_3 = 1.08 \text{ F},$$

$$C_4 = 0.924 \text{ F}.$$

The preceding values for  $C_1$ ,  $C_2$ ,  $C_3$ , and  $C_4$  yield a fourth-order Butterworth filter with a cutoff frequency of 1 rad/s. A frequency scale factor of  $k_f = 3141.6$  will move the cutoff frequency to 500 Hz. A magnitude scale factor of  $k_m = 1000$  will permit the use of 1 k $\Omega$  resistors in place of 1  $\Omega$  resistors. The resulting scaled component values are

$$R = 1 \text{ k}\Omega,$$

$$C_1 = 831 \text{ nF},$$

$$C_2 = 121 \text{ nF},$$

$$C_3 = 344 \text{ nF},$$

$$C_4 = 294 \text{ nF}.$$

Finally, we need to specify the resistor values in the inverting amplifier stage to yield a passband gain of 10. Let  $R_1 = 1\text{ k}\Omega$ ; then

$$R_f = 10R_1 = 10\text{ k}\Omega.$$

Figure 15.23 compares the magnitude responses of the fourth-order identical cascade filter from Example 15.7 and the Butterworth filter

we just designed. Note that both filters provide a passband gain of 10 (20 dB) and a cutoff frequency of 500 Hz, but the Butterworth filter is closer to an ideal low-pass filter due to its flatter passband and steeper rolloff at the cutoff frequency. Thus, the Butterworth design is preferred over the identical cascade design.

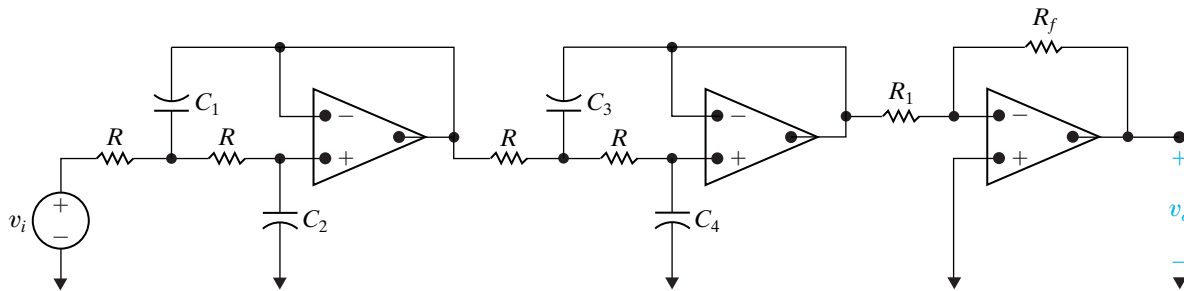


Figure 15.22 ▲ A fourth-order Butterworth filter with non-unity gain.

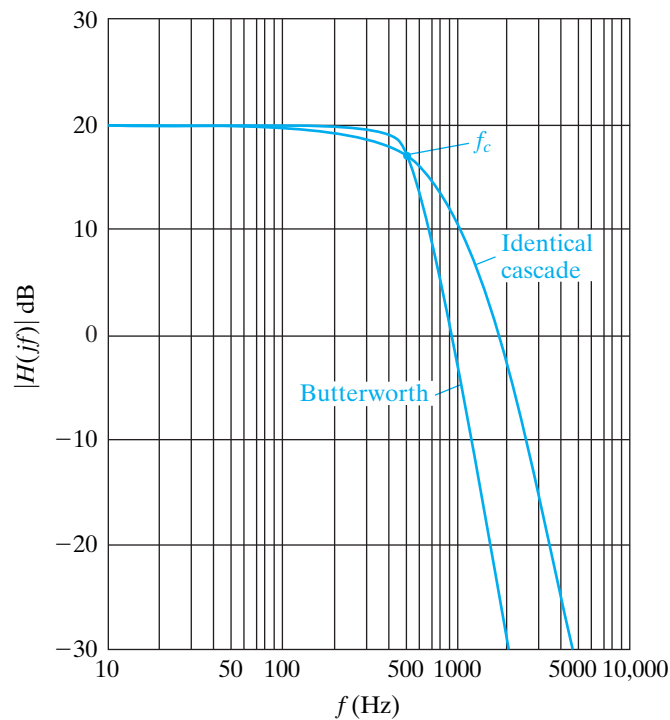


Figure 15.23 ▲ A comparison of the magnitude responses for a fourth-order low-pass filter using the identical cascade and Butterworth designs.

### The Order of a Butterworth Filter

It should be apparent at this point that the higher the order of the Butterworth filter, the closer the magnitude characteristic comes to that of an ideal low-pass filter. In other words, as  $n$  increases, the magnitude stays close to unity in the passband, the transition band narrows, and the magnitude stays close to zero in the stopband. At the same time, as the order increases, the number of circuit components increases. It follows then that

a fundamental problem in the design of a filter is to determine the smallest value of  $n$  that will meet the filtering specifications.

In the design of a low-pass filter, the filtering specifications are usually given in terms of the abruptness of the transition region, as shown in Fig. 15.24. Once  $A_p$ ,  $\omega_p$ ,  $A_s$ , and  $\omega_s$  are specified, the order of the Butterworth filter can be determined.

For the Butterworth filter,

$$\begin{aligned} A_p &= 20 \log_{10} \frac{1}{\sqrt{1 + \omega_p^{2n}}} \\ &= -10 \log_{10}(1 + \omega_p^{2n}), \end{aligned} \quad (15.37)$$

$$\begin{aligned} A_s &= 20 \log_{10} \frac{1}{\sqrt{1 + \omega_s^{2n}}} \\ &= -10 \log_{10}(1 + \omega_s^{2n}). \end{aligned} \quad (15.38)$$

It follows from the definition of the logarithm that

$$10^{-0.1A_p} = 1 + \omega_p^{2n}, \quad (15.39)$$

$$10^{-0.1A_s} = 1 + \omega_s^{2n}. \quad (15.40)$$

Now we solve for  $\omega_p^n$  and  $\omega_s^n$  and then form the ratio  $(\omega_s/\omega_p)^n$ . We get

$$\left(\frac{\omega_s}{\omega_p}\right)^n = \frac{\sqrt{10^{-0.1A_s} - 1}}{\sqrt{10^{-0.1A_p} - 1}} = \frac{\sigma_s}{\sigma_p}, \quad (15.41)$$

where the symbols  $\sigma_s$  and  $\sigma_p$  have been introduced for convenience.

From Eq. 15.41 we can write

$$n \log_{10}(\omega_s/\omega_p) = \log_{10}(\sigma_s/\sigma_p),$$

or

$$n = \frac{\log_{10}(\sigma_s/\sigma_p)}{\log_{10}(\omega_s/\omega_p)}. \quad (15.42)$$

We can simplify Eq. 15.42 if  $\omega_p$  is the cutoff frequency, because then  $A_p$  equals  $-20 \log_{10} \sqrt{2}$ , and  $\sigma_p = 1$ . Hence

$$n = \frac{\log_{10} \sigma_s}{\log_{10}(\omega_s/\omega_p)}. \quad (15.43)$$

One further simplification is possible. We are using a Butterworth filter to achieve a steep transition region. Therefore, the filtering specification will make  $10^{-0.1A_s} \gg 1$ . Thus

$$\sigma_s \approx 10^{-0.05A_s}, \quad (15.44)$$

$$\log_{10} \sigma_s \approx -0.05A_s. \quad (15.45)$$

Therefore, a good approximation for the calculation of  $n$  is

$$n = \frac{-0.05A_s}{\log_{10}(\omega_s/\omega_p)}. \quad (15.46)$$

Note that  $\omega_s/\omega_p = f_s/f_p$ , so we can work with either radians per second or hertz to calculate  $n$ .

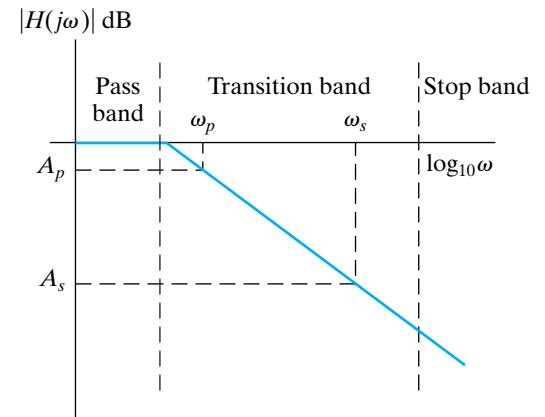


Figure 15.24 ▲ Defining the transition region for a low-pass filter.

The order of the filter must be an integer; hence, in using either Eq. 15.42 or Eq. 15.46, we must select the nearest integer value greater than the result given by the equation. The following examples illustrate the usefulness of Eqs. 15.42 and 15.46.

### Example 15.10 Determining the Order of a Butterworth Filter

- a) Determine the order of a Butterworth filter that has a cutoff frequency of 1000 Hz and a gain of no more than  $-50$  dB at 6000 Hz.
- b) What is the actual gain in dB at 6000 Hz?

#### Solution

- a) Because the cutoff frequency is given, we know  $\sigma_p = 1$ . We also note from the specification that

$10^{-0.1(-50)}$  is much greater than 1. Hence, we can use Eq. 15.46 with confidence:

$$n = \frac{(-0.05)(-50)}{\log_{10}(6000/1000)} = 3.21.$$

Therefore, we need a fourth-order Butterworth filter.

- b) We can use Eq. 15.25 to calculate the actual gain at 6000 Hz. The gain in decibels will be

$$K = 20 \log_{10} \left( \frac{1}{\sqrt{1 + 6^8}} \right) = -62.25 \text{ dB}.$$

### Example 15.11 An Alternate Approach to Determining the Order of a Butterworth Filter

- a) Determine the order of a Butterworth filter whose magnitude is 10 dB less than the passband magnitude at 500 Hz and at least 60 dB less than the passband magnitude at 5000 Hz.
- b) Determine the cutoff frequency of the filter (in hertz).
- c) What is the actual gain of the filter (in decibels) at 5000 Hz?

#### Solution

- a) Because the cutoff frequency is not given, we use Eq. 15.42 to determine the order of the filter:

$$\sigma_p = \sqrt{10^{-0.1(-10)} - 1} = 3,$$

$$\sigma_s = \sqrt{10^{-0.1(-60)} - 1} \approx 1000,$$

$$\omega_s/\omega_p = f_s/f_p = 5000/500 = 10,$$

$$n = \frac{\log_{10}(1000/3)}{\log_{10}(10)} = 2.52.$$

Therefore we need a third-order Butterworth filter to meet the specifications.

- b) Knowing that the gain at 500 Hz is  $-10$  dB, we can determine the cutoff frequency. From Eq. 15.25 we can write

$$-10 \log_{10}[1 + (\omega/\omega_c)^6] = -10,$$

where  $\omega = 1000\pi$  rad/s. Therefore

$$1 + (\omega/\omega_c)^6 = 10,$$

and

$$\begin{aligned} \omega_c &= \frac{\omega}{\sqrt[6]{9}} \\ &= 2178.26 \text{ rad/s}. \end{aligned}$$

It follows that

$$f_c = 346.68 \text{ Hz}.$$

- c) The actual gain of the filter at 5000 Hz is

$$\begin{aligned} K &= -10 \log_{10}[1 + (5000/346.68)^6] \\ &= -69.54 \text{ dB}. \end{aligned}$$

## Butterworth High-Pass, Bandpass, and Bandreject Filters

An  $n$ th-order Butterworth high-pass filter has a transfer function with the  $n$ th-order Butterworth polynomial in the denominator, just like the  $n$ th-order Butterworth low-pass filter. But in the high-pass filter, the numerator of the transfer function is  $s^n$ , whereas in the low-pass filter, the numerator is 1. Again, we use a cascade approach in designing the Butterworth high-pass filter. The first-order factor is achieved by including a prototype high-pass filter (Fig. 15.4, with  $R_1 = R_2 = 1 \Omega$ , and  $C = 1 \text{ F}$ ) in the cascade.

To produce the second-order factors in the Butterworth polynomial, we need a circuit with a transfer function of the form

$$H(s) = \frac{s^2}{s^2 + b_1s + 1}.$$

Such a circuit is shown in Fig. 15.25.

This circuit has the transfer function

$$H(s) = \frac{V_o}{V_i} = \frac{s^2}{s^2 + \frac{2}{R_2C}s + \frac{1}{R_1R_2C^2}}. \quad (15.47)$$

Setting  $C = 1 \text{ F}$  yields

$$H(s) = \frac{s^2}{s^2 + \frac{2}{R_2}s + \frac{1}{R_1R_2}}. \quad (15.48)$$

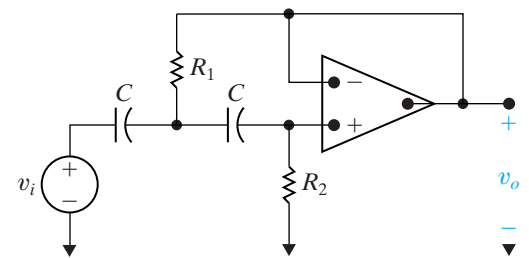
Thus, we can realize any second-order factor in a Butterworth polynomial of the form  $(s^2 + b_1s + 1)$  by including in the cascade the second-order circuit in Fig. 15.25 with resistor values that satisfy Eq. 15.49:

$$b_1 = \frac{2}{R_2} \quad \text{and} \quad 1 = \frac{1}{R_1R_2}. \quad (15.49)$$

At this point, we pause to make a couple of observations relative to Figs. 15.21 and 15.25 and their prototype transfer functions  $1/(s^2 + b_1s + 1)$  and  $s^2/(s^2 + b_1s + 1)$ . These observations are important because they are true in general. First, the high-pass circuit in Fig. 15.25 was obtained from the low-pass circuit in Fig. 15.21 by interchanging resistors and capacitors. Second, the prototype transfer function of a high-pass filter can be obtained from that of a low-pass filter by replacing  $s$  in the low-pass expression with  $1/s$  (see Problem 15.46).

We can use frequency and magnitude scaling to design a Butterworth high-pass filter with practical component values and a cutoff frequency other than 1 rad/s. Adding an inverting amplifier to the cascade will accommodate designs with nonunity passband gains. The problems at the end of the chapter include several Butterworth high-pass filter designs.

Now that we can design both  $n$ th-order low-pass and high-pass Butterworth filters with arbitrary cutoff frequencies and passband gains, we can combine these filters in cascade (as we did in Section 15.3) to produce  $n$ th-order Butterworth bandpass filters. We can combine these filters in parallel with a summing amplifier (again, as we did in Section 15.3) to produce  $n$ th-order Butterworth bandreject filters. This chapter's problems also include Butterworth bandpass and bandreject filter designs.



**Figure 15.25** ▲ A second-order Butterworth high-pass filter circuit.



## ASSESSMENT PROBLEM

### Objective 3—Understand how to use cascaded first- and second-order Butterworth filters

**15.4** For the circuit in Fig. 15.25, find values of  $R_1$  and  $R_2$  that yield a second-order prototype Butterworth high-pass filter.

**Answer:**  $R_1 = 0.707 \Omega$ ,  $R_2 = 1.41 \Omega$ .

*NOTE:* Also try Chapter Problems 15.34, 15.36 and 15.40.

## 15.5 Narrowband Bandpass and Bandreject Filters

The cascade and parallel component designs for synthesizing bandpass and bandreject filters from simpler low-pass and high-pass filters have the restriction that only broadband, or low- $Q$ , filters will result. (The  $Q$ , of course, stands for *quality factor*.) This limitation is due principally to the fact that the transfer functions for cascaded bandpass and parallel bandreject filters have discrete real poles. The synthesis techniques work best for cutoff frequencies that are widely separated and therefore yield the lowest quality factors. But the largest quality factor we can achieve with discrete real poles arises when the cutoff frequencies, and thus the pole locations, are the same. Consider the transfer function that results:

$$\begin{aligned} H(s) &= \left( \frac{-\omega_c}{s + \omega_c} \right) \left( \frac{-s}{s + \omega_c} \right) \\ &= \frac{s\omega_c}{s^2 + 2\omega_c s + \omega_c^2} \\ &= \frac{0.5\beta s}{s^2 + \beta s + \omega_c^2}. \end{aligned} \quad (15.50)$$

Eq. 15.50 is in the standard form of the transfer function of a bandpass filter, and thus we can determine the bandwidth and center frequency directly:

$$\beta = 2\omega_c, \quad (15.51)$$

$$\omega_o^2 = \omega_c^2. \quad (15.52)$$

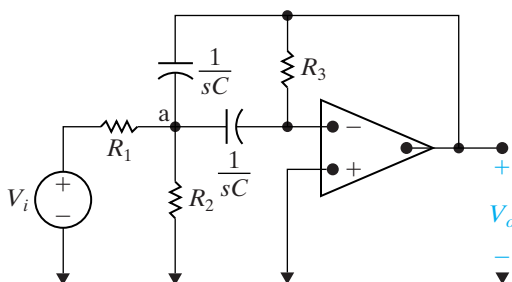
From Eqs. 15.51 and 15.52 and the definition of  $Q$ , we see that

$$Q = \frac{\omega_o}{\beta} = \frac{\omega_c}{2\omega_c} = \frac{1}{2}. \quad (15.53)$$

Thus with discrete real poles, the highest quality bandpass filter (or bandreject filter) we can achieve has  $Q = 1/2$ .

To build active filters with high quality factor values, we need an op amp circuit that can produce a transfer function with complex conjugate poles. Figure 15.26 depicts one such circuit for us to analyze. At the inverting input of the op amp, we sum the currents to get

$$\frac{V_a}{1/sC} = \frac{-V_o}{R_3}.$$



**Figure 15.26** ▲ An active high- $Q$  bandpass filter.

Solving for  $V_a$ ,

$$V_a = \frac{-V_o}{sR_3C}. \quad (15.54)$$

At the node labeled a, we sum the currents to get

$$\frac{V_i - V_a}{R_1} = \frac{V_a - V_o}{1/sC} + \frac{V_a}{1/sC} + \frac{V_a}{R_2}.$$

Solving for  $V_i$ ,

$$V_i = (1 + 2sR_1C + R_1/R_2)V_a - sR_1CV_o. \quad (15.55)$$

Substituting Eq. 15.54 into Eq. 15.55 and then rearranging, we get an expression for the transfer function  $V_o/V_i$ :

$$H(s) = \frac{\frac{-s}{R_1C}}{s^2 + \frac{2}{R_3C}s + \frac{1}{R_{eq}R_3C^2}}, \quad (15.56)$$

where

$$R_{eq} = R_1 \parallel R_2 = \frac{R_1R_2}{R_1 + R_2}.$$

Since Eq. 15.56 is in the standard form of the transfer function for a bandpass filter, that is,

$$H(s) = \frac{-K\beta s}{s^2 + \beta s + \omega_o^2},$$

we can equate terms and solve for the values of the resistors, which will achieve a specified center frequency ( $\omega_o$ ), quality factor ( $Q$ ), and passband gain ( $K$ ):

$$\beta = \frac{2}{R_3C}; \quad (15.57)$$

$$K\beta = \frac{1}{R_1C}; \quad (15.58)$$

$$\omega_o^2 = \frac{1}{R_{eq}R_3C^2}. \quad (15.59)$$

At this point, it is convenient to define the prototype version of the circuit in Fig. 15.25 as a circuit in which  $\omega_o = 1$  rad/s and  $C = 1$  F. Then the expressions for  $R_1$ ,  $R_2$ , and  $R_3$  can be given in terms of the desired quality factor and passband gain. We leave you to show (in Problem 15.48) that for the prototype circuit, the expressions for  $R_1$ ,  $R_2$ , and  $R_3$  are

$$\begin{aligned} R_1 &= Q/K, \\ R_2 &= Q/(2Q^2 - K), \\ R_3 &= 2Q. \end{aligned}$$

Scaling is used to specify practical values for the circuit components. This design process is illustrated in Example 15.12.

### Example 15.12 Designing a High- $Q$ Bandpass Filter

Design a bandpass filter, using the circuit in Fig. 15.26, which has a center frequency of 3000 Hz, a quality factor of 10, and a passband gain of 2. Use  $0.01 \mu\text{F}$  capacitors in your design. Compute the transfer function of your circuit, and sketch a Bode plot of its magnitude response.

#### Solution

Since  $Q = 10$  and  $K = 2$ , the values for  $R_1$ ,  $R_2$ , and  $R_3$  in the prototype circuit are

$$R_1 = 10/2 = 5,$$

$$R_2 = 10/(200 - 2) = 10/198,$$

$$R_3 = 2(10) = 20.$$

The scaling factors are  $k_f = 6000\pi$  and  $k_m = 10^8/k_f$ . After scaling,

$$R_1 = 26.5 \text{ k}\Omega,$$

$$R_2 = 268.0 \Omega,$$

$$R_3 = 106.1 \text{ k}\Omega.$$

The circuit is shown in Fig. 15.27.

Substituting the values of resistance and capacitance in Eq. 15.56 gives the transfer function for this circuit:

$$H(s) = \frac{-3770s}{s^2 + 1885.0s + 355 \times 10^6}.$$

It is easy to see that this transfer function meets the specification of the bandpass filter defined in the example. A Bode plot of its magnitude response is sketched in Fig. 15.28.

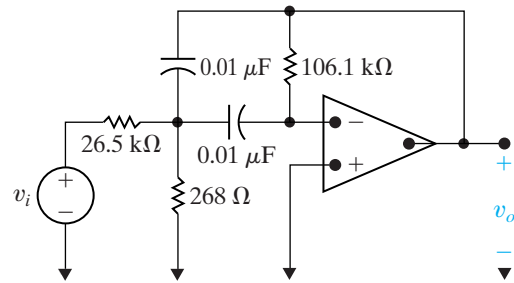


Figure 15.27 ▲ The high- $Q$  bandpass filter designed in Example 15.12.

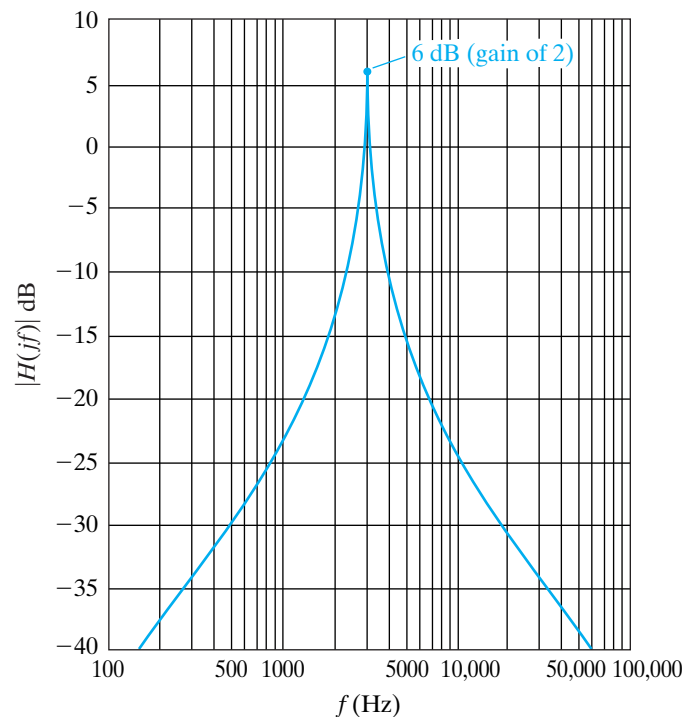


Figure 15.28 ▲ The Bode magnitude plot for the high- $Q$  bandpass filter designed in Example 15.12.

The parallel implementation of a bandreject filter that combines low-pass and high-pass filter components with a summing amplifier has the same low- $Q$  restriction as the cascaded bandpass filter. The circuit in Fig. 15.29 is an active high- $Q$  bandreject filter known as the **twin-T notch filter** because of the two T-shaped parts of the circuit at the nodes labeled a and b.

We begin the analysis of this circuit by summing the currents away from node a:

$$(V_a - V_i)sC + (V_a - V_o)sC + \frac{2(V_a - \sigma V_o)}{R} = 0$$

or

$$V_a [2sCR + 2] - V_o [sCR + 2\sigma] = sCRV_i. \quad (15.60)$$

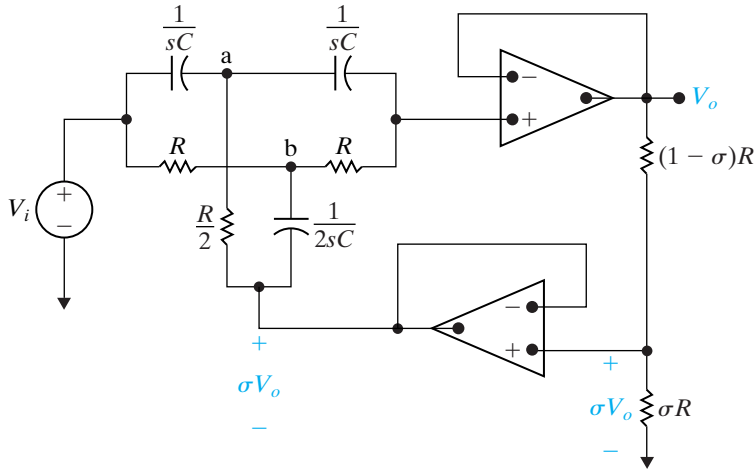


Figure 15.29 ▲ A high- $Q$  active bandreject filter.

Summing the currents away from node  $b$  yields

$$\frac{V_b - V_i}{R} + \frac{V_b - V_o}{R} + (V_b - \sigma V_o)2sC = 0$$

or

$$V_b [2 + 2RCs] - V_o [1 + 2\sigma RCs] = V_i. \quad (15.61)$$

Summing the currents away from the noninverting input terminal of the top op amp gives

$$(V_o - V_a)sC + \frac{V_o - V_b}{R} = 0$$

or

$$-sRCV_a - V_b + (sRC + 1)V_o = 0. \quad (15.62)$$

From Eqs. 15.60–15.62, we can use Cramer's rule to solve for  $V_o$ :

$$V_o = \frac{\begin{vmatrix} 2(RCs + 1) & 0 & sCRV_i \\ 0 & 2(RCs + 1) & V_i \\ -RCs & -1 & 0 \end{vmatrix}}{\begin{vmatrix} 2(RCs + 1) & 0 & -(RCs + 2\sigma) \\ 0 & 2(RCs + 1) & -(2\sigma RCs + 1) \\ -RCs & -1 & RCs + 1 \end{vmatrix}}$$

$$= \frac{(R^2C^2s^2 + 1)V_i}{R^2C^2s^2 + 4RC(1 - \sigma)s + 1}. \quad (15.63)$$

Rearranging Eq. 15.63, we can solve for the transfer function:

$$H(s) = \frac{V_o}{V_i} = \frac{\left(s^2 + \frac{1}{R^2C^2}\right)}{\left[s^2 + \frac{4(1 - \sigma)}{RC}s + \frac{1}{R^2C^2}\right]}, \quad (15.64)$$

which is in the standard form for the transfer function of a bandreject filter:

$$H(s) = \frac{s^2 + \omega_0^2}{s^2 + \beta s + \omega_0^2}. \quad (15.65)$$

Equating Eqs. 15.64 and 15.65 gives

$$\omega_0^2 = \frac{1}{R^2 C^2}, \quad (15.66)$$

$$\beta = \frac{4(1 - \sigma)}{RC}. \quad (15.67)$$

In this circuit, we have three parameters ( $R$ ,  $C$ , and  $\sigma$ ) and two design constraints ( $\omega_0$  and  $\beta$ ). Thus one parameter is chosen arbitrarily; it is usually the capacitor value because this value typically provides the fewest commercially available options. Once  $C$  is chosen,

$$R = \frac{1}{\omega_0 C}, \quad (15.68)$$

and

$$\sigma = 1 - \frac{\beta}{4\omega_0} = 1 - \frac{1}{4Q}. \quad (15.69)$$

Example 15.13 illustrates the design of a high- $Q$  active bandreject filter.

### Example 15.13 Designing a High- $Q$ Bandreject Filter

Design a high- $Q$  active bandreject filter (based on the circuit in Fig. 15.29) with a center frequency of 5000 rad/s and a bandwidth of 1000 rad/s. Use  $1 \mu\text{F}$  capacitors in your design.

#### Solution

In the bandreject prototype filter,  $\omega_0 = 1 \text{ rad/s}$ ,  $R = 1 \Omega$ , and  $C = 1 \text{ F}$ . As just discussed, once  $\omega_0$  and  $Q$  are given,  $C$  can be chosen arbitrarily, and  $R$  and  $\sigma$  can be found from Eqs. 15.68 and 15.69. From the specifications,  $Q = 5$ . Using Eqs. 15.68 and 15.69, we see that

$$R = 200 \Omega,$$

$$\sigma = 0.95.$$

Therefore we need resistors with the values  $200 \Omega$  ( $R$ ),  $100 \Omega$  ( $R/2$ ),  $190 \Omega$  ( $\sigma R$ ), and  $10 \Omega$   $[(1 - \sigma)R]$ . The final design is depicted in Fig. 15.30, and the Bode magnitude plot is shown in Fig. 15.31.

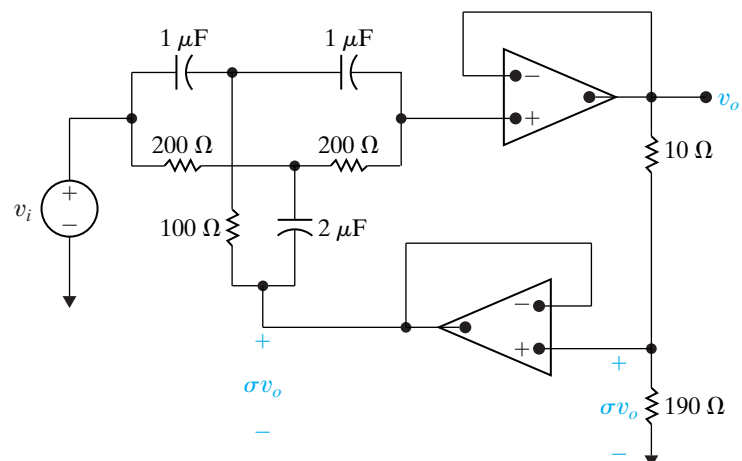
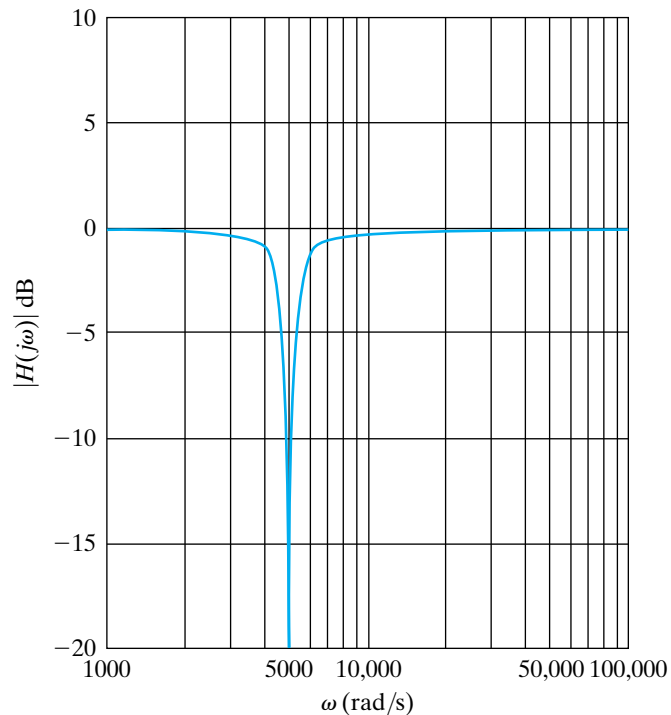


Figure 15.30 ▲ The high- $Q$  active bandreject filter designed in Example 15.13.



**Figure 15.31** ▲ The Bode magnitude plot for the high- $Q$  active bandreject filter designed in Example 15.13.

## ✓ ASSESSMENT PROBLEMS

**Objective 4**—Be able to use design equations to calculate component values for prototype narrowband, bandpass, and bandreject filters

**15.5** Design an active bandpass filter with  $Q = 8$ ,  $K = 5$ , and  $\omega_o = 1000$  rad/s. Use  $1 \mu\text{F}$  capacitors, and specify the values of all resistors.

**Answer:**  $R_1 = 1.6 \text{ k}\Omega$ ,  $R_2 = 65.04 \Omega$ ,  $R_3 = 16 \text{ k}\Omega$ .

**15.6** Design an active unity-gain bandreject filter with  $\omega_o = 1000$  rad/s and  $Q = 4$ . Use  $2 \mu\text{F}$  capacitors in your design, and specify the values of  $R$  and  $\sigma$ .

**Answer:**  $R = 500 \Omega$ ,  $\sigma = 0.9375$ .

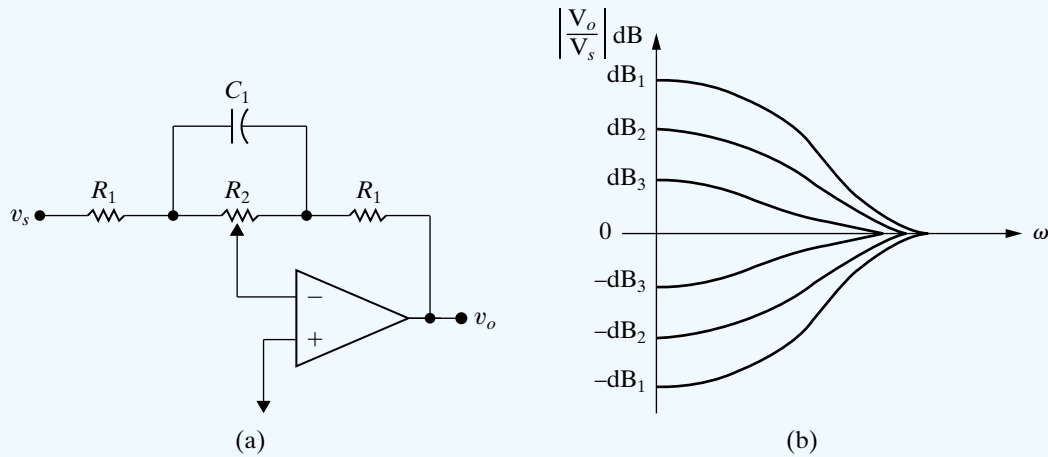
*NOTE:* Also try Chapter Problem 15.60.

## Practical Perspective

### Bass Volume Control

We now look at an op amp circuit that can be used to control the amplification of an audio signal in the bass range. The audio range consists of signals having frequencies from 20 Hz to 20 kHz. The bass range includes frequencies up to 300 Hz. The volume control circuit and its frequency response are shown in Fig. 15.32. The particular response curve in the family of response curves is selected by adjusting the potentiometer setting in Fig. 15.32(a).

In studying the frequency response curves in Fig. 15.32(b) note the following. First, the gain in dB can be either positive or negative. If the gain is positive a signal in the bass range is amplified or boosted. If the gain is negative the signal is attenuated or cut. Second, it is possible to select a

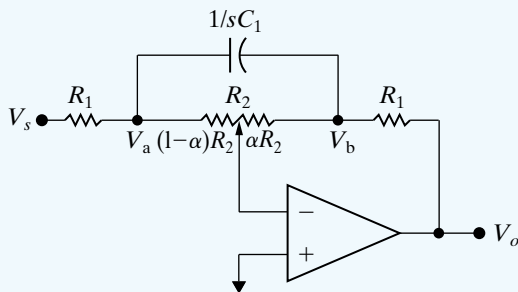


**Figure 15.32** ▲ (a) Bass volume control circuit; (b) Bass volume control circuit frequency response.

response characteristic that yields unity gain (zero dB) for all frequencies in the bass range. As we shall see, if the potentiometer is set at its midpoint, the circuit will have no effect on signals in the bass range. Finally, as the frequency increases, all the characteristic responses approach zero dB or unity gain. Hence the volume control circuit will have no effect on signals in the upper end or treble range of the audio frequencies.

The first step in analyzing the frequency response of the circuit in Fig. 15.32(a) is to calculate the transfer function  $V_o/V_s$ . To facilitate this calculation the  $s$ -domain equivalent circuit is given in Fig. 15.33. The node voltages  $V_a$  and  $V_b$  have been labeled in the circuit to support node voltage analysis. The position of the potentiometer is determined by the numerical value of  $\alpha$ , as noted in Fig. 15.33.

To find the transfer function we write the three node voltage equations that describe the circuit and then solve the equations for the voltage ratio  $V_o/V_s$ . The node voltage equations are



**Figure 15.33** ▲ The  $s$ -domain circuit for the bass volume control. Note that  $\alpha$  determines the potentiometer setting, so  $0 \leq \alpha \leq 1$ .

$$\begin{aligned} \frac{V_a}{(1-\alpha)R_2} + \frac{V_a - V_s}{R_1} + (V_a - V_b)s C_1 &= 0; \\ \frac{V_b}{\alpha R_2} + (V_b - V_a)s C_1 + \frac{V_b - V_o}{R_1} &= 0; \\ \frac{V_a}{(1-\alpha)R_2} + \frac{V_b}{\alpha R_2} &= 0. \end{aligned}$$

These three node-voltage equations can be solved to find  $V_o$  as a function of  $V_s$  and hence the transfer function  $H(s)$ :

$$H(s) = \frac{V_o}{V_s} = \frac{-(R_1 + \alpha R_2 + R_1 R_2 C_1 s)}{R_1 + (1 - \alpha) R_2 + R_1 R_2 C_1 s}$$

It follows directly that

$$H(j\omega) = \frac{-(R_1 + \alpha R_2 + j\omega R_1 R_2 C_1)}{[R_1 + (1 - \alpha) R_2 + j\omega R_1 R_2 C_1]}$$

Now let's verify that this transfer function will generate the family of frequency response curves depicted in Fig. 15.32(b). First note that when  $\alpha = 0.5$  the magnitude of  $H(j\omega)$  is unity for all frequencies, i.e.,

$$|H(j\omega)| = \frac{|R_1 + 0.5R_2 + j\omega R_1 R_2 C_1|}{|R_1 + 0.5R_2 + j\omega R_1 R_2 C_1|} = 1.$$



When  $\omega = 0$  we have

$$|H(j0)| = \frac{R_1 + \alpha R_2}{R_1 + (1 - \alpha)R_2}.$$

Observe that  $|H(j0)|$  at  $\alpha = 1$  is the reciprocal of  $|H(j0)|$  at  $\alpha = 0$ , that is

$$|H(j0)|_{\alpha=1} = \frac{R_1 + R_2}{R_1} = \frac{1}{|H(j0)|_{\alpha=0}}.$$

With a little thought the reader can see that the reciprocal relationship holds for all frequencies, not just  $\omega = 0$ . For example  $\alpha = 0.4$  and  $\alpha = 0.6$  are symmetric with  $\alpha = 0.5$  and

$$H(j\omega)_{\alpha=0.4} = \frac{-(R_1 + 0.4R_2) + j\omega R_1 R_2 C_1}{(R_1 + 0.6R_2) + j\omega R_1 R_2 C_1}$$

while

$$H(j\omega)_{\alpha=0.6} = \frac{-(R_1 + 0.6R_2) + j\omega R_1 R_2 C_1}{(R_1 + 0.4R_2) + j\omega R_1 R_2 C_1}.$$

Hence

$$H(j\omega)_{\alpha=0.4} = \frac{1}{H(j\omega)_{\alpha=0.6}}.$$

It follows that depending on the value of  $\alpha$  the volume control circuit can either amplify or attenuate the incoming signal.

The numerical values of  $R_1$ ,  $R_2$ , and  $C_1$  are based on two design decisions. The first design choice is the passband amplification or attenuation in the bass range (as  $\omega \rightarrow 0$ ). The second design choice is the frequency at which this passband amplification or attenuation is changed by 3 dB. The component values which satisfy the design decisions are calculated with  $\alpha$  equal to either 1 or 0.

As we have already observed, the maximum gain will be  $(R_1 + R_2)/R_1$  and the maximum attenuation will be  $R_1/(R_1 + R_2)$ . If we assume  $(R_1 + R_2)/R_1 \gg 1$  then the gain (or attenuation) will differ by 3 dB from its maximum value when  $\omega = 1/R_2 C_1$ . This can be seen by noting that

$$\begin{aligned} \left| H\left(j\frac{1}{R_2 C_1}\right) \right|_{\alpha=1} &= \frac{|R_1 + R_2 + jR_1|}{|R_1 + jR_1|} \\ &= \frac{\left| \frac{R_1 + R_2}{R_1} + j1 \right|}{|1 + j1|} \approx \frac{1}{\sqrt{2}} \left( \frac{R_1 + R_2}{R_1} \right) \end{aligned}$$

and

$$\begin{aligned} \left| H\left(j\frac{1}{R_2 C_1}\right) \right|_{\alpha=0} &= \frac{|R_1 + jR_1|}{|R_1 + R_2 + jR_1|} \\ &= \frac{|1 + j1|}{\left| \frac{R_1 + R_2}{R_1} + j1 \right|} \approx \sqrt{2} \left( \frac{R_1}{R_1 + R_2} \right). \end{aligned}$$

*NOTE: Assess your understanding of this Practical Perspective by trying Chapter Problems 15.61 and 15.62.*

## Summary

- Active filters consist of op amps, resistors, and capacitors. They can be configured as low-pass, high-pass, bandpass, and bandreject filters. They overcome many of the disadvantages associated with passive filters. (See page 558.)
- A **prototype low-pass filter** has component values of  $R_1 = R_2 = 1 \Omega$  and  $C = 1 \text{ F}$ , and it produces a unity passband gain and a cutoff frequency of 1 rad/s. The **prototype high-pass filter** has the same component values and also produces a unity passband gain and a cutoff frequency of 1 rad/s. (See pages 559 and 560.)
- Magnitude scaling** can be used to alter component values without changing the frequency response of a circuit. For a magnitude scale factor of  $k_m$ , the scaled (primed) values of resistance, capacitance, and inductance are

$$R' = k_m R, \quad L' = k_m L, \quad \text{and} \quad C' = C/k_m.$$

(See page 562.)

- Frequency scaling** can be used to shift the frequency response of a circuit to another frequency region without changing the overall shape of the frequency response. For a frequency scale factor of  $k_f$ , the scaled (primed) values of resistance, capacitance, and inductance are

$$R' = R, \quad L' = L/k_f, \quad \text{and} \quad C' = C/k_f.$$

(See page 562.)

- Components can be scaled in both magnitude and frequency, with the scaled (primed) component values given by

$$R' = k_m R, \quad L' = (k_m/k_f)L, \quad \text{and} \quad C' = C/(k_m k_f).$$

(See page 562.)

- The design of active low-pass and high-pass filters can begin with a prototype filter circuit. Scaling can then be applied to shift the frequency response to the desired cutoff frequency, using component values that are commercially available. (See page 563.)
- An active broadband bandpass filter can be constructed using a cascade of a low-pass filter with the bandpass filter's upper cutoff frequency, a high-pass filter with the bandpass filter's lower cutoff frequency, and (optionally) an inverting amplifier gain stage to achieve nonunity gain in the passband. Bandpass filters implemented in this fashion must be broadband filters ( $\omega_{c2} \gg \omega_{c1}$ ), so that the elements of the cascade can be specified independently of one another. (See page 566.)
- An active broadband bandreject filter can be constructed using a parallel combination of a low-pass filter with the bandreject filter's lower cutoff frequency and a

high-pass filter with the bandreject filter's upper cutoff frequency. The outputs are then fed into a summing amplifier, which can produce nonunity gain in the passband. Bandreject filters implemented in this way must be broadband filters ( $\omega_{c2} \gg \omega_{c1}$ ), so that the low-pass and high-pass filter circuits can be designed independently of one another. (See page 570.)

- Higher order active filters have multiple poles in their transfer functions, resulting in a sharper transition from the passband to the stopband and thus a more nearly ideal frequency response. (See page 571.)
- The transfer function of an  $n$ th-order Butterworth low-pass filter with a cutoff frequency of 1 rad/s can be determined from the equation

$$H(s)H(-s) = \frac{1}{1 + (-1)^n s^{2n}}$$

by

- finding the roots of the denominator polynomial
- assigning the left-half plane roots to  $H(s)$
- writing the denominator of  $H(s)$  as a product of first- and second-order factors

(See page 576–577.)

- The fundamental problem in the design of a Butterworth filter is to determine the order of the filter. The filter specification usually defines the sharpness of the transition band in terms of the quantities  $A_p$ ,  $\omega_p$ ,  $A_s$ , and  $\omega_s$ . From these quantities, we calculate the smallest integer larger than the solution to either Eq. 15.42 or Eq. 15.46. (See page 581.)
- A cascade of second-order low-pass op amp filters (Fig. 15.21) with 1  $\Omega$  resistors and capacitor values chosen to produce each factor in the Butterworth polynomial will produce an even-order Butterworth low-pass filter. Adding a prototype low-pass op amp filter will produce an odd-order Butterworth low-pass filter. (See page 579.)
- A cascade of second-order high-pass op amp filters (Fig. 15.25) with 1 F capacitors and resistor values chosen to produce each factor in the Butterworth polynomial will produce an even-order Butterworth high-pass filter. Adding a prototype high-pass op amp filter will produce an odd-order Butterworth high-pass filter. (See page 583.)
- For both high- and low-pass Butterworth filters, frequency and magnitude scaling can be used to shift the cutoff frequency from 1 rad/s and to include realistic

component values in the design. Cascading an inverting amplifier will produce a nonunity passband gain. (See page 578.)

- Butterworth low-pass and high-pass filters can be cascaded to produce Butterworth bandpass filters of any order  $n$ . Butterworth low-pass and high-pass filters can be combined in parallel with a summing amplifier to produce a Butterworth bandreject filter of any order  $n$ . (See page 583.)

- If a high- $Q$ , or narrowband, bandpass, or bandreject filter is needed, the cascade or parallel combination will not work. Instead, the circuits shown in Figs. 15.26 and 15.29 are used with the appropriate design equations. Typically, capacitor values are chosen from those commercially available, and the design equations are used to specify the resistor values. (See page 584.)

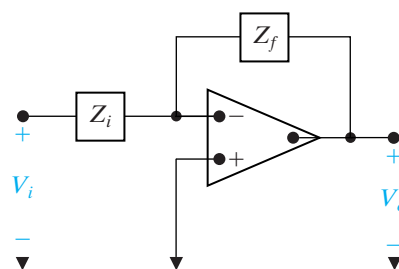
## Problems

### Section 15.1

- 15.1** a) Using the circuit in Fig. 15.1, design a low-pass filter with a passband gain of 10 dB and a cutoff frequency of 1 kHz. Assume a 750 nF capacitor is available.
- DESIGN PROBLEM
- b) Draw the circuit diagram and label all components.
- 15.2** a) Using only three components from Appendix H, design a low-pass filter with a cutoff frequency and passband gain as close as possible to the specifications in Problem 15.1(a). Draw the circuit diagram and label all component values.
- b) Calculate the percent error in this new filter's cutoff frequency and passband gain when compared to the values specified in Problem 15.1(a).
- 15.3** Design an op amp-based low-pass filter with a cutoff frequency of 2500 Hz and a passband gain of 5 using a 10 nF capacitor.
- a) Draw your circuit, labeling the component values and output voltage.
- b) If the value of the feedback resistor in the filter is changed but the value of the resistor in the forward path is unchanged, what characteristic of the filter is changed?
- 15.4** The input to the low-pass filter designed in Problem 15.3 is  $3.5 \cos \omega t$  V.
- a) Suppose the power supplies are  $\pm V_{cc}$ . What is the smallest value of  $V_{cc}$  that will still cause the op amp to operate in its linear region?
- b) Find the output voltage when  $\omega = \omega_c$ .
- c) Find the output voltage when  $\omega = 0.125\omega_c$ .
- d) Find the output voltage when  $\omega = 8\omega_c$ .

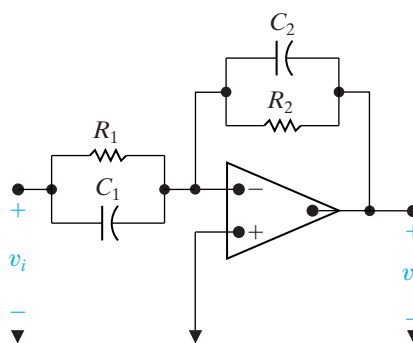
- 15.5** Find the transfer function  $V_o/V_i$  for the circuit shown in Fig. P15.5 if  $Z_f$  is the equivalent impedance of the feedback circuit,  $Z_i$  is the equivalent impedance of the input circuit, and the operational amplifier is ideal.

Figure P15.5



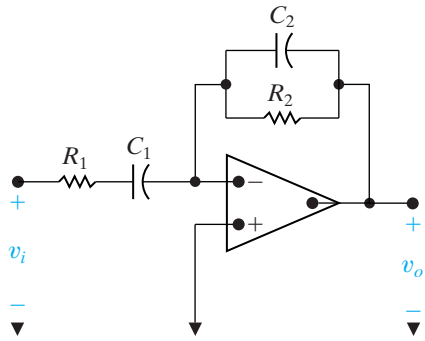
- 15.6** a) Use the results of Problem 15.5 to find the transfer function of the circuit shown in Fig. P15.6.
- b) What is the gain of the circuit as  $\omega \rightarrow 0$ ?
- c) What is the gain of the circuit as  $\omega \rightarrow \infty$ ?
- d) Do your answers to (b) and (c) make sense in terms of known circuit behavior?

Figure P15.6



- 15.7** Repeat Problem 15.6, using the circuit shown in Fig. P15.7.

Figure P15.7



**15.8** a) Use the circuit in Fig. 15.4 to design a high-pass filter with a cutoff frequency of 8 kHz and a passband gain of 14 dB. Use a 3.9 nF capacitor in the design.

**DESIGN PROBLEM**

b) Draw the circuit diagram of the filter and label all the components.

**15.9** Using only three components from Appendix H, design a high-pass filter with a cutoff frequency and passband gain as close as possible to the specifications in Problem 15.8.

a) Draw the circuit diagram and label all component values.

b) Calculate the percent error in this new filter's cutoff frequency and passband gain when compared to the values specified in Problem 15.10(a).

**15.10** Design an op amp-based high-pass filter with a cutoff frequency of 4 kHz and a passband gain of 8 using a 250 nF capacitor.

a) Draw your circuit, labeling the component values and the output voltage.

b) If the value of the feedback resistor in the filter is changed but the value of the resistor in the forward path is unchanged, what characteristic of the filter is changed?

**15.11** The input to the high-pass filter designed in Problem 15.10 is  $2.5 \cos \omega t$  V.

a) Suppose the power supplies are  $\pm V_{cc}$ . What is the smallest value of  $V_{cc}$  that will still cause the op amp to operate in its linear region?

b) Find the output voltage when  $\omega = \omega_c$ .

c) Find the output voltage when  $\omega = 0.125\omega_c$ .

d) Find the output voltage when  $\omega = 8\omega_c$ .

**Section 15.2**

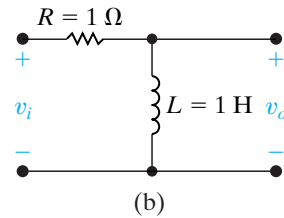
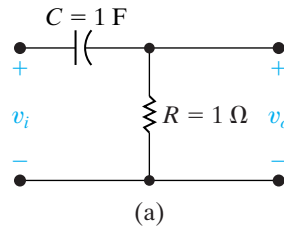
**15.12** The voltage transfer function for either high-pass prototype filter shown in Fig. P15.12 is

$$H(s) = \frac{s}{s + 1}$$

Show that if either circuit is scaled in both magnitude and frequency, the scaled transfer function is

$$H'(s) = \frac{(s/k_f)}{(s/k_f) + 1}$$

Figure P15.12



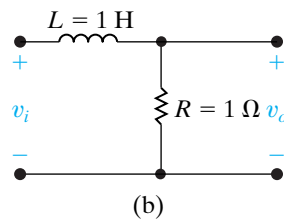
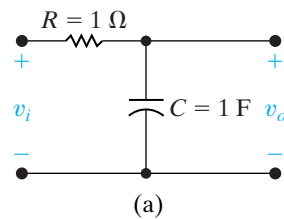
**15.13** The voltage transfer function of either low-pass prototype filter shown in Fig. P15.13 is

$$H(s) = \frac{1}{s + 1}$$

Show that if either circuit is scaled in both magnitude and frequency, the scaled transfer function is

$$H'(s) = \frac{1}{(s/k_f) + 1}$$

Figure P15.13



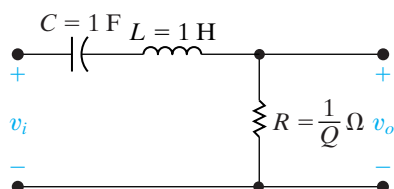
**15.14** The voltage transfer function of the prototype bandpass filter shown in Fig. P15.14 is

$$H(s) = \frac{\left(\frac{1}{Q}\right)s}{s^2 + \left(\frac{1}{Q}\right)s + 1}$$

Show that if the circuit is scaled in both magnitude and frequency, the scaled transfer function is

$$H'(s) = \frac{\left(\frac{1}{Q}\right)\left(\frac{s}{k_f}\right)}{\left(\frac{s}{k_f}\right)^2 + \left(\frac{1}{Q}\right)\left(\frac{s}{k_f}\right) + 1}$$

Figure P15.14

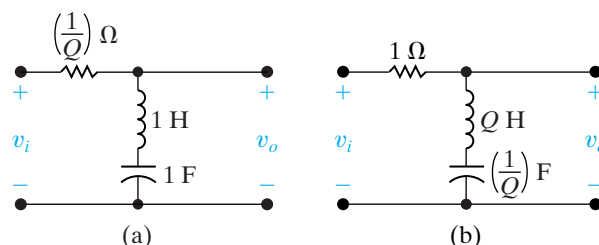


- 15.15** a) Specify the component values for the prototype passive bandpass filter described in Problem 15.14 if the quality factor of the filter is 20.
- b) Specify the component values for the scaled bandpass filter described in Problem 15.14 if the quality factor is 20; the center, or resonant, frequency is 40 krad/s; and the impedance at resonance is 5 k $\Omega$ .
- c) Draw a circuit diagram of the scaled filter and label all the components.
- 15.16** An alternative to the prototype bandpass filter illustrated in Fig. P15.14 is to make  $\omega_o = 1$  rad/s,  $R = 1 \Omega$ , and  $L = Q$  henrys.
- a) What is the value of  $C$  in the prototype filter circuit?
- b) What is the transfer function of the prototype filter?
- c) Use the alternative prototype circuit just described to design a passive bandpass filter that has a quality factor of 16, a center frequency of 25 krad/s, and an impedance of 10 k $\Omega$  at resonance.
- d) Draw a diagram of the scaled filter and label all the components.
- e) Use the results obtained in Problem 15.14 to write the transfer function of the scaled circuit.
- 15.17** DESIGN PROBLEM The passive bandpass filter illustrated in Fig. 14.22 has two prototype circuits. In the first prototype circuit,  $\omega_o = 1$  rad/s,  $C = 1$  F,  $L = 1$  H, and  $R = Q$  ohms. In the second prototype circuit,  $\omega_o = 1$  rad/s,  $R = 1 \Omega$ ,  $C = Q$  farads, and  $L = (1/Q)$  henrys.
- a) Use one of these prototype circuits (your choice) to design a passive bandpass filter that has a quality factor of 25 and a center frequency of 50 krad/s. The resistor  $R$  is 40 k $\Omega$ .
- b) Draw a circuit diagram of the scaled filter and label all components.
- 15.18** The passive bandreject filter illustrated in Fig. 14.28(a) has the two prototype circuits shown in Fig. P15.18.
- a) Show that for both circuits, the transfer function is

$$H(s) = \frac{s^2 + 1}{s^2 + \left(\frac{1}{Q}\right)s + 1}$$

- b) Write the transfer function for a bandreject filter that has a center frequency of 8000 rad/s and a quality factor of 10.

Figure P15.18



- 15.19** The transfer function for the bandreject filter shown in Fig. 14.28(a) is

$$H(s) = \frac{s^2 + \left(\frac{1}{LC}\right)}{s^2 + \left(\frac{R}{L}\right)s + \left(\frac{1}{LC}\right)}$$

Show that if the circuit is scaled in both magnitude and frequency, the transfer function of the scaled circuit is equal to the transfer function of the unscaled circuit with  $s$  replaced by  $(s/k_f)$ , where  $k_f$  is the frequency scale factor.

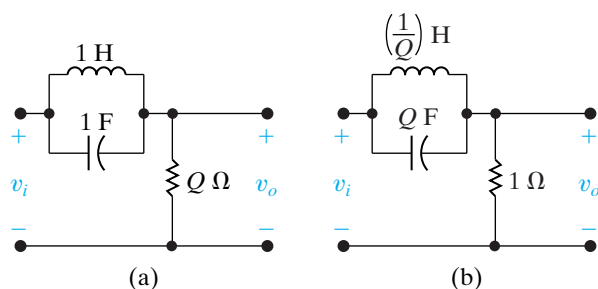
- 15.20** Show that the observation made in Problem 15.19 with respect to the transfer function for the circuit in Fig. 14.28(a) also applies to the bandreject filter circuit (lower one) in Fig. 14.31.

- 15.21** The two prototype versions of the passive bandreject filter shown in Fig. 14.31 (lower circuit) are shown in Fig. P15.21(a) and (b).

Show that the transfer function for either version is

$$H(s) = \frac{s^2 + 1}{s^2 + \left(\frac{1}{Q}\right)s + 1}$$

Figure P15.21



**15.22** The circuit in Fig. P9.24 is scaled so that the  $200\ \Omega$  resistor is replaced by  $80\ \Omega$  resistor and the  $400\ \text{mH}$  inductor is replaced by a  $20\ \text{mH}$  inductor.

- What is the scaled value of the capacitor?
- Find the frequency for which the impedance  $Z_{ab}$  is purely resistive for the scaled circuit.
- How is the frequency you found in part (b) related to the frequency for which the impedance  $Z_{ab}$  is purely resistive in the un-scaled circuit?

**15.23** Scale the inductor and capacitor in Fig. P9.66 so that the magnitude and the phase angle of the output current do not change when the input frequency is changed from  $250\ \text{rad/sec}$  to  $10,000\ \text{rad/sec}$ .

- What are the scaled values of the inductor and capacitor?
- What is the steady-state value of the output current,  $i_o$ , when the input current is  $60 \cos 10,000t\ \text{mA}$ ?

**15.24** Scale the bandpass filter in Problem 14.18 so that the center frequency is  $25\ \text{kHz}$  and the quality factor is still 8, using a  $25\ \mu\text{H}$  inductor. Determine the values of the resistor and the capacitor, and the two cutoff frequencies of the scaled filter.

**15.25** Scale the bandreject filter in Problem 14.38 to get a center frequency of  $16\ \text{krad/s}$ , using a  $50\ \text{nF}$  capacitor. Determine the values of the resistor, the inductor, and the bandwidth of the scaled filter.

**15.26** a) Show that if the low-pass filter circuit illustrated in Fig. 15.1 is scaled in both magnitude and frequency, the transfer function of the scaled circuit is the same as Eq. 15.1 with  $s$  replaced by  $s/k_f$ , where  $k_f$  is the frequency scale factor.

- In the prototype version of the low-pass filter circuit in Fig. 15.1,  $\omega_c = 1\ \text{rad/s}$ ,  $C = 1\ \text{F}$ ,  $R_2 = 1\ \Omega$ , and  $R_1 = 1/K$  ohms. What is the transfer function of the prototype circuit?
- Using the result obtained in (a), derive the transfer function of the scaled filter.

**15.27** a) Show that if the high-pass filter illustrated in Fig. 15.4 is scaled in both magnitude and frequency, the transfer function is the same as

Eq. 15.4 with  $s$  replaced by  $s/k_f$ , where  $k_f$  is the frequency scale factor.

- In the prototype version of the high-pass filter circuit in Fig. 15.4,  $\omega_c = 1\ \text{rad/s}$ ,  $R_1 = 1\ \Omega$ ,  $C = 1\ \text{F}$ , and  $R_2 = K$  ohms. What is the transfer function of the prototype circuit?
- Using the result in (a), derive the transfer function of the scaled filter.

### Section 15.3

**15.28** a) Using  $50\ \text{nF}$  capacitors, design an active broadband first-order bandpass filter that has a lower cutoff frequency of  $200\ \text{Hz}$ , an upper cutoff frequency of  $2000\ \text{Hz}$ , and a passband gain of  $20\ \text{dB}$ . Use prototype versions of the low-pass and high-pass filters in the design process (see Problems 15.26 and 15.27).

DESIGN  
PROBLEM  
PSpICE  
MULTISIM

- Write the transfer function for the scaled filter.
- Use the transfer function derived in part (b) to find  $H(j\omega_o)$ , where  $\omega_o$  is the center frequency of the filter.
- What is the passband gain (in decibels) of the filter at  $\omega_o$ ?
- Using a computer program of your choice, make a Bode magnitude plot of the filter.

**15.29** a) Using  $2\ \mu\text{F}$  capacitors, design an active broadband first-order bandreject filter with a lower cutoff frequency of  $80\ \text{Hz}$ , an upper cutoff frequency of  $800\ \text{Hz}$ , and a passband gain of  $0\ \text{dB}$ . Use the prototype filter circuits introduced in Problems 15.26 and 15.27 in the design process.

DESIGN  
PROBLEM  
PSpICE  
MULTISIM

- Draw the circuit diagram of the filter and label all the components.
- What is the transfer function of the scaled filter?
- Evaluate the transfer function derived in (c) at the center frequency of the filter.
- What is the gain (in decibels) at the center frequency?
- Using a computer program of your choice, make a Bode magnitude plot of the filter transfer function.

**15.30** Design a unity-gain bandpass filter, using a cascade connection, to give a center frequency of  $200\ \text{Hz}$  and a bandwidth of  $1000\ \text{Hz}$ . Use  $5\ \mu\text{F}$  capacitors. Specify  $f_{c1}$ ,  $f_{c2}$ ,  $R_L$ , and  $R_H$ .

**15.31** Design a parallel bandreject filter with a center frequency of  $1000\ \text{rad/s}$ , a bandwidth of  $4000\ \text{rad/s}$ , and a passband gain of 6. Use  $0.2\ \mu\text{F}$  capacitors, and specify all resistor values.

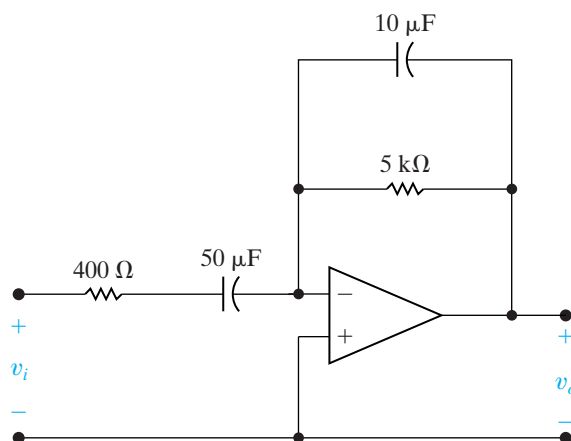
**15.32** Show that the circuit in Fig. P15.32 behaves as a bandpass filter. (*Hint*—find the transfer function for this circuit and show that it has the same form as



the transfer function for a bandpass filter. Use the result from Problem 15.1.)

- Find the center frequency, bandwidth and gain for this bandpass filter.
- Find the cutoff frequencies and the quality for this bandpass filter.

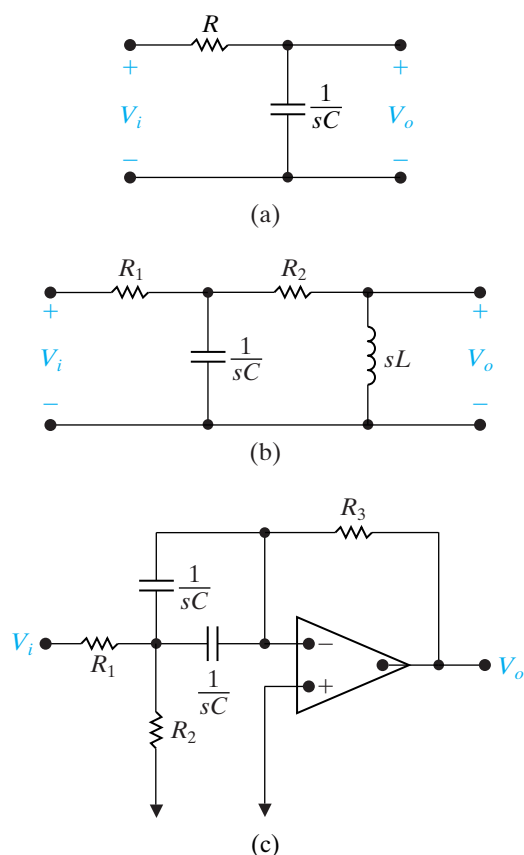
Figure P15.32



- 15.33** For circuits consisting of resistors, capacitors, inductors, and op amps,  $|H(j\omega)|^2$  involves only even powers of  $\omega$ . To illustrate this, compute  $|H(j\omega)|^2$  for the three circuits in Fig. P15.33 when

$$H(s) = \frac{V_o}{V_i}$$

Figure P15.33



### Section 15.4

- 15.34** a) Determine the order of a low-pass Butterworth filter that has a cutoff frequency of 2000 Hz and a gain of no more than  $-30$  dB at 7000 Hz.  
b) What is the actual gain, in decibels, at 7000 Hz?
- 15.35** The circuit in Fig. 15.21 has the transfer function given by Eq. 15.34. Show that if the circuit in Fig. 15.21 is scaled in both magnitude and frequency, the transfer function of the scaled circuit is

$$H'(s) = \frac{1}{\left(\frac{s}{k_f}\right)^2 + \frac{2}{RC_1}\left(\frac{s}{k_f}\right) + \frac{1}{R^2C_1C_2}}$$

- 15.36** a) Write the transfer function for the prototype low-pass Butterworth filter obtained in Problem 15.34(a).  
b) Write the transfer function for the scaled filter in (a) (see Problem 15.35).  
c) Check the expression derived in part (b) by using it to calculate the gain (in decibels) at 7000 Hz. Compare your result with that found in Problem 15.34(b).

- 15.37** a) Using  $1$  k $\Omega$  resistors and ideal op amps, design a circuit that will implement the low-pass Butterworth filter specified in Problem 15.34. The gain in the passband is one.

- b) Construct the circuit diagram and label all component values.

- 15.38** The purpose of this problem is to illustrate the advantage of an  $n$ th-order low-pass Butterworth filter over the cascade of  $n$  identical low-pass sections by calculating the slope (in decibels per decade) of each magnitude plot at the corner frequency  $\omega_c$ . To facilitate the calculation, let  $y$  represent the magnitude of the plot (in decibels), and let  $x = \log_{10}\omega$ . Then calculate  $dy/dx$  at  $\omega_c$  for each plot.

- a) Show that at the corner frequency ( $\omega_c = 1$  rad/s) of an  $n$ th-order low-pass prototype Butterworth filter,

$$\frac{dy}{dx} = -10n \text{ dB/dec.}$$

- b) Show that for a cascade of  $n$  identical low-pass prototype sections, the slope at  $\omega_c$  is

$$\frac{dy}{dx} = \frac{-20n(2^{1/n} - 1)}{2^{1/n}} \text{ dB/dec.}$$

- c) Compute  $dy/dx$  for each type of filter for  $n = 1, 2, 3, 4$ , and  $\infty$ .  
d) Discuss the significance of the results obtained in part (c).

- 15.39** Verify the entries in Table 15.1 for  $n = 5$  and  $n = 6$ .
- 15.40** The circuit in Fig. 15.25 has the transfer function given by Eq. 15.47. Show that if the circuit is scaled in both magnitude and frequency, the transfer function of the scaled circuit is

$$H'(s) = \frac{\left(\frac{s}{k_f}\right)^2}{\left(\frac{s}{k_f}\right)^2 + \frac{2}{R_2 C} \left(\frac{s}{k_f}\right) + \frac{1}{R_1 R_2 C^2}}.$$

Hence the transfer function of a scaled circuit is obtained from the transfer function of an unscaled circuit by simply replacing  $s$  in the unscaled transfer function by  $s/k_f$ , where  $k_f$  is the frequency scaling factor.

- 15.41** a) Using 8 k $\Omega$  resistors and ideal op amps, design a high-pass unity-gain Butterworth filter that has a cutoff frequency of 2.5 kHz and has a gain of no more than  $-55$  dB at 500 Hz.

DESIGN PROBLEM

- b) Draw a circuit diagram of the filter and label all the components.

- 15.42** a) Using 250 nF capacitors and ideal op amps, design a low-pass unity-gain Butterworth filter with a cutoff frequency of 40 kHz and is down at least  $-55$  dB at 200 kHz.

DESIGN PROBLEM

- b) Draw a circuit diagram of the filter and label all component values.

- 15.43** The high-pass filter designed in Problem 15.41 is cascaded with the low-pass filter designed in Problem 15.42.

- a) Describe the type of filter formed by this interconnection.
- b) Specify the cutoff frequencies, the mid-frequency, and the quality factor of the filter.
- c) Use the results of Problems 15.35 and 15.40 to derive the scaled transfer function of the filter.
- d) Check the derivation of (c) by using it to calculate  $H(j\omega_o)$ , where  $\omega_o$  is the midfrequency of the filter.

- 15.44** a) Design a broadband Butterworth bandpass filter with a lower cutoff frequency of 200 Hz and an upper cutoff frequency of 2500 Hz. The passband gain of the filter is 40 dB. The gain should be down at least 40 dB at 40 Hz and 12.5 kHz. Use 1  $\mu$ F capacitors in the high-pass circuit and 2.5 k $\Omega$  resistors in the low-pass circuit.

DESIGN PROBLEM

- b) Draw a circuit diagram of the filter and label all the components.

- 15.45** a) Derive the expression for the scaled transfer function for the filter designed in Problem 15.44.

- b) Using the expression derived in (a), find the gain (in decibels) at 40 Hz and 1000 Hz.
- c) Do the values obtained in part (b) satisfy the filtering specifications given in Problem 15.44?

- 15.46** Derive the prototype transfer function for a fifth-order high-pass Butterworth filter by first writing the transfer function for a fifth-order prototype low-pass Butterworth filter and then replacing  $s$  by  $1/s$  in the low-pass expression.

- 15.47** The fifth-order Butterworth filter in Problem 15.46 is used in a system where the cutoff frequency is 800 rad/s.

- a) What is the scaled transfer function for the filter?
- b) Test your expression by finding the gain (in decibels) at the cutoff frequency.

- 15.48** Show that if  $\omega_o = 1$  rad/s and  $C = 1$  F in the circuit in Fig. 15.26, the prototype values of  $R_1$ ,  $R_2$ , and  $R_3$  are

$$R_1 = \frac{Q}{K},$$

$$R_2 = \frac{Q}{2Q^2 - K},$$

$$R_3 = 2Q.$$

- 15.49** a) Use 20 nF capacitors in the circuit in Fig. 15.26 to design a bandpass filter with a quality factor of 16, a center frequency of 6.4 kHz, and a passband gain of 20 dB.

DESIGN PROBLEM

- b) Draw the circuit diagram of the filter and label all the components.

- 15.50** The purpose of this problem is to guide you through the analysis necessary to establish a design procedure for determining the circuit components in a filter circuit. The circuit to be analyzed is shown in Fig. P15.50.

DESIGN PROBLEM

- a) Analyze the circuit qualitatively and convince yourself that the circuit is a low-pass filter with a passband gain of  $R_2/R_1$ .

- b) Support your qualitative analysis by deriving the transfer function  $V_o/V_i$ . (*Hint:* In deriving the transfer function, represent the resistors with their equivalent conductances, that is,  $G_1 = 1/R_1$ , and so forth.) To make the transfer function useful in terms of the entries in Table 15.1, put it in the form

$$H(s) = \frac{-Kb_o}{s^2 + b_1s + b_o}.$$

- c) Now observe that we have five circuit components— $R_1$ ,  $R_2$ ,  $R_3$ ,  $C_1$ , and  $C_2$ —and three transfer function constraints— $K$ ,  $b_1$ , and  $b_o$ . At



first glance, it appears we have two free choices among the five components. However, when we investigate the relationships between the circuit components and the transfer function constraints, we see that if  $C_2$  is chosen, there is an upper limit on  $C_1$  in order for  $R_2(G_2)$  to be realizable. With this in mind, show that if  $C_2 = 1$  F, the three conductances are given by the expressions

$$G_1 = KG_2;$$

$$G_3 = \left(\frac{b_o}{G_2}\right)C_1;$$

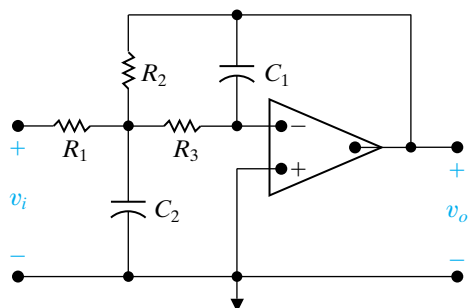
$$G_2 = \frac{b_1 \pm \sqrt{b_1^2 - 4b_o(1+K)C_1}}{2(1+K)}.$$

For  $G_2$  to be realizable,

$$C_1 \leq \frac{b_1^2}{4b_o(1+K)}.$$

- d) Based on the results obtained in (c), outline the design procedure for selecting the circuit components once  $K$ ,  $b_o$ , and  $b_1$  are known.

Figure P15.50



**15.51** Assume the circuit analyzed in Problem 15.50 is part of a third-order low-pass Butterworth filter having a passband gain of 4. (*Hint:* implement the gain of 4 in the second-order section of the filter.)

DESIGN PROBLEM

- If  $C_2 = 1$  F in the prototype second-order section, what is the upper limit on  $C_1$ ?
- If the limiting value of  $C_1$  is chosen, what are the prototype values of  $R_1$ ,  $R_2$ , and  $R_3$ ?
- If the corner frequency of the filter is 2.5 kHz and  $C_2$  is chosen to be 10 nF, calculate the scaled values of  $C_1$ ,  $R_1$ ,  $R_2$ , and  $R_3$ .
- Specify the scaled values of the resistors and the capacitor in the first-order section of the filter.
- Construct a circuit diagram of the filter and label all the component values on the diagram.

**15.52** Interchange the  $R$ s and  $C$ s in the circuit in Fig. P15.50; that is, replace  $R_1$  with  $C_1$ ,  $R_2$  with  $C_2$ ,  $R_3$  with  $C_3$ ,  $C_1$  with  $R_1$ , and  $C_2$  with  $R_2$ .

DESIGN PROBLEM

- Describe the type of filter implemented as a result of the interchange.
- Confirm the filter type described in (a) by deriving the transfer function  $V_o/V_i$ . Write the transfer function in a form that makes it compatible with Table 15.1.
- Set  $C_2 = C_3 = 1$  F and derive the expressions for  $C_1$ ,  $R_1$ , and  $R_2$  in terms of  $K$ ,  $b_1$ , and  $b_o$ . (See Problem 15.50 for the definition of  $b_1$  and  $b_o$ .)
- Assume the filter described in (a) is used in the same type of third-order Butterworth filter that has a passband gain of 8. With  $C_2 = C_3 = 1$  F, calculate the prototype values of  $C_1$ ,  $R_1$ , and  $R_2$  in the second-order section of the filter.

**15.53**  
DESIGN PROBLEM

- Use the circuits analyzed in Problems 15.50 and 15.52 to implement a broadband bandreject filter having a passband gain of 20 dB, a lower corner frequency of 1 kHz, an upper corner frequency of 8 kHz, and an attenuation of at least 24 dB at both 2 kHz and 4 kHz. Use 25 nF capacitors whenever possible.
- Draw a circuit diagram of the filter and label all the components.

**15.54** a) Derive the transfer function for the bandreject filter described in Problem 15.53.

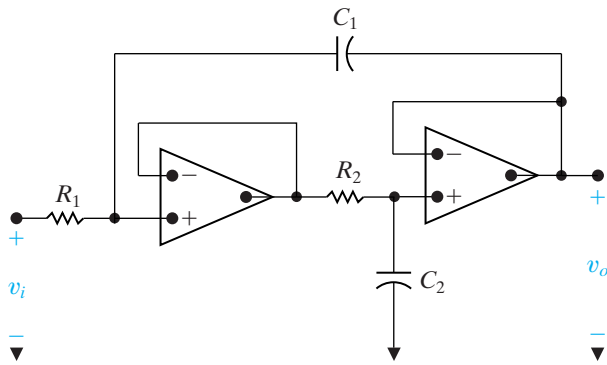
- Use the transfer function derived in part (a) to find the attenuation (in decibels) at the center frequency of the filter.

**15.55** The purpose of this problem is to develop the design equations for the circuit in Fig. P15.55. (See Problem 15.50 for suggestions on the development of design equations.)

DESIGN PROBLEM

- Based on a qualitative analysis, describe the type of filter implemented by the circuit.
- Verify the conclusion reached in (a) by deriving the transfer function  $V_o/V_i$ . Write the transfer function in a form that makes it compatible with the entries in Table 15.1.
- How many free choices are there in the selection of the circuit components?
- Derive the expressions for the conductances  $G_1 = 1/R_1$  and  $G_2 = 1/R_2$  in terms of  $C_1$ ,  $C_2$ , and the coefficients  $b_o$  and  $b_1$ . (See Problem 15.50 for the definition of  $b_o$  and  $b_1$ .)
- Are there any restrictions on  $C_1$  or  $C_2$ ?
- Assume the circuit in Fig. P15.55 is used to design a fourth-order low-pass unity-gain Butterworth filter. Specify the prototype values of  $R_1$  and  $R_2$  in each second-order section if 1 F capacitors are used in the prototype circuit.

Figure P15.55



**15.56** The fourth-order low-pass unity-gain Butterworth filter in Problem 15.55 is used in a system where the cutoff frequency is 3 kHz. The filter has 4.7 nF capacitors.

DESIGN PROBLEM

- Specify the numerical values of  $R_1$  and  $R_2$  in each section of the filter.
- Draw a circuit diagram of the filter and label all the components.

**15.57** Interchange the  $R$ s and  $C$ s in the circuit in Fig. P15.55, that is, replace  $R_1$  with  $C_1$ ,  $R_2$  with  $C_2$ , and vice versa.

DESIGN PROBLEM

- Analyze the circuit qualitatively and predict the type of filter implemented by the circuit.
- Verify the conclusion reached in (a) by deriving the transfer function  $V_o/V_i$ . Write the transfer function in a form that makes it compatible with the entries in Table 15.1.
- How many free choices are there in the selection of the circuit components?
- Find  $R_1$  and  $R_2$  as functions of  $b_o$ ,  $b_1$ ,  $C_1$ , and  $C_2$ .
- Are there any restrictions on  $C_1$  and  $C_2$ ?
- Assume the circuit is used in a third-order Butterworth filter of the type found in (a). Specify the prototype values of  $R_1$  and  $R_2$  in the second-order section of the filter if  $C_1 = C_2 = 1$  F.

**15.58** a) The circuit in Problem 15.57 is used in a third-order high-pass unity-gain Butterworth filter that has a cutoff frequency of 800 Hz. Specify the values of  $R_1$  and  $R_2$  if 5  $\mu$ F capacitors are available to construct the filter.

DESIGN PROBLEM

- Specify the values of resistance and capacitance in the first-order section of the filter.
- Draw the circuit diagram and label all the components.
- Give the numerical expression for the scaled transfer function of the filter.
- Use the scaled transfer function derived in (d) to find the gain in dB at the cutoff frequency.

## Section 15.5

**15.59** a) Show that the transfer function for a prototype narrow band bandreject filter is

$$H(s) = \frac{s^2 + 1}{s^2 + (1/Q)s + 1}$$

- Use the result found in (a) to find the transfer function of the filter designed in Example 15.13.

**15.60** a) Using the circuit shown in Fig. 15.29, design a narrow-band bandreject filter having a center frequency of 4 kHz and a quality factor of 10. Base the design on  $C = 0.5$   $\mu$ F.

DESIGN PROBLEM

- Draw the circuit diagram of the filter and label all component values on the diagram.
- What is the scaled transfer function of the filter?

## Sections 15.1–15.5

**15.61** Using the circuit in Fig. 15.32(a) design a volume control circuit to give a maximum gain of 14 dB and a gain of 11 dB at a frequency of 50 Hz. Use a 10 k $\Omega$  resistor and a 50 k $\Omega$  potentiometer. Test your design by calculating the maximum gain at  $\omega = 0$  and the gain at  $\omega = 1/R_2C_1$  using the selected values of  $R_1$ ,  $R_2$ , and  $C_1$ .

PRACTICAL PERSPECTIVE DESIGN PROBLEM

**15.62** Use the circuit in Fig. 15.32(a) to design a bass volume control circuit that has a maximum gain of 20 dB that drops off 3 dB at 75 Hz.

PRACTICAL PERSPECTIVE DESIGN PROBLEM

**15.63** Plot the maximum gain in decibels versus  $\alpha$  when  $\omega = 0$  for the circuit designed in Problem 15.61. Let  $\alpha$  vary from 0 to 1 in increments of 0.1.

PRACTICAL PERSPECTIVE

**15.64** a) Show that the circuits in Fig. P15.64(a) and (b) are equivalent.

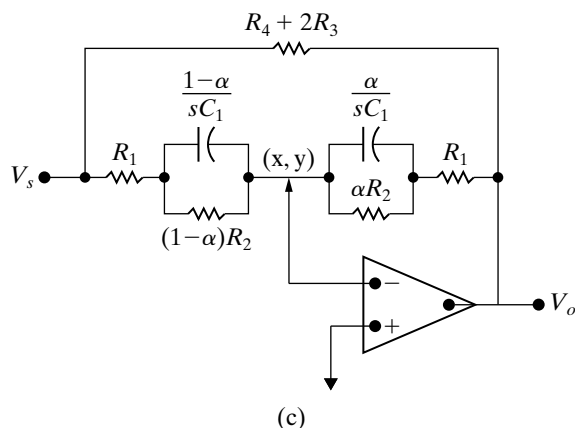
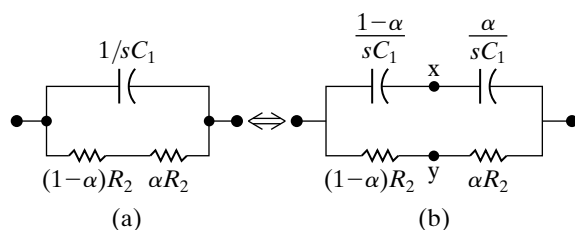
PRACTICAL PERSPECTIVE

- Show that the points labeled x and y in Fig. P15.64(b) are always at the same potential.
- Using the information in (a) and (b), show that the circuit in Fig. 15.33 can be drawn as shown in Fig. P15.64(c).
- Show that the circuit in Fig. P15.64(c) is in the form of the circuit in Fig. 15.2, where

$$Z_i = \frac{R_1 + (1 - \alpha)R_2 + R_1R_2C_1s}{1 + R_2C_1s},$$

$$Z_f = \frac{R_1 + \alpha R_2 + R_1R_2C_1s}{1 + R_2C_1s}.$$

Figure P15.64



- 15.65** An engineering project manager has received a proposal from a subordinate who claims the circuit shown in Fig. P15.65 could be used as a treble volume control circuit if  $R_4 \gg R_1 + R_3 + 2R_2$ . The subordinate further claims that the voltage transfer function for the circuit is

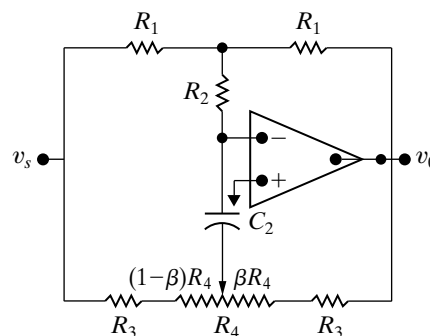
$$H(s) = \frac{V_o}{V_s} = \frac{-\{(2R_3 + R_4) + [(1 - \beta)R_4 + R_o](\beta R_4 + R_3)C_2s\}}{\{(2R_3 + R_4) + [(1 - \beta)R_4 + R_3](\beta R_4 + R_o)C_2s\}}$$

where  $R_o = R_1 + R_3 + 2R_2$ . Fortunately the project engineer has an electrical engineering undergraduate

student as an intern and therefore asks the student to check the subordinate's claim.

The student is asked to check the behavior of the transfer function as  $\omega \rightarrow 0$ ; as  $\omega \rightarrow \infty$ ; and the behavior when  $\omega = \infty$  and  $\beta$  varies between 0 and 1. Based on your testing of the transfer function do you think the circuit could be used as a treble volume control? Explain.

Figure P15.65



- 15.66** In the circuit of Fig. P15.65 the component values are  $R_1 = R_2 = 20 \text{ k}\Omega$ ,  $R_3 = 5.9 \text{ k}\Omega$ ,  $R_4 = 500 \text{ k}\Omega$ , and  $C_2 = 2.7 \text{ nF}$ .

- Calculate the maximum boost in decibels.
- Calculate the maximum cut in decibels.
- Is  $R_4$  significantly greater than  $R_o$ ?
- When  $\beta = 1$ , what is the boost in decibels when  $\omega = 1/R_3C_2$ ?
- When  $\beta = 0$ , what is the cut in decibels when  $\omega = 1/R_3C_2$ ?
- Based on the results obtained in (d) and (e), what is the significance of the frequency  $1/R_3C_2$  when  $R_4 \gg R_o$ ?

- 15.67** Using the component values given in Problem 15.66, plot the maximum gain in decibels versus  $\beta$  when  $\omega$  is infinite. Let  $\beta$  vary from 0 to 1 in increments of 0.1.

# CHAPTER 16

## CHAPTER CONTENTS

- 16.1 **Fourier Series Analysis: An Overview** *p. 605*
- 16.2 **The Fourier Coefficients** *p. 606*
- 16.3 **The Effect of Symmetry on the Fourier Coefficients** *p. 609*
- 16.4 **An Alternative Trigonometric Form of the Fourier Series** *p. 615*
- 16.5 **An Application** *p. 617*
- 16.6 **Average-Power Calculations with Periodic Functions** *p. 621*
- 16.7 **The rms Value of a Periodic Function** *p. 624*
- 16.8 **The Exponential Form of the Fourier Series** *p. 625*
- 16.9 **Amplitude and Phase Spectra** *p. 628*

## ✓ CHAPTER OBJECTIVES

- 1 Be able to calculate the trigonometric form of the Fourier coefficients for a periodic waveform using the definition of the coefficients and the simplifications possible if the waveform exhibits one or more types of symmetry.
- 2 Know how to analyze a circuit's response to a periodic waveform using Fourier coefficients and superposition.
- 3 Be able to estimate the average power delivered to a resistor using a small number of Fourier coefficients.
- 4 Be able to calculate the exponential form of the Fourier coefficients for a periodic waveform and use them to generate magnitude and phase spectrum plots for that waveform.

# Fourier Series

In the preceding chapters, we devoted a considerable amount of discussion to steady-state sinusoidal analysis. One reason for this interest in the sinusoidal excitation function is that it allows us to find the steady-state response to nonsinusoidal, but periodic, excitations. A **periodic function** is a function that repeats itself every  $T$  seconds. For example, the triangular wave illustrated in Fig. 16.1 on page 604 is a nonsinusoidal, but periodic, break waveform.

A periodic function is one that satisfies the relationship

$$f(t) = f(t \pm nT), \quad (16.1)$$

where  $n$  is an integer (1, 2, 3, ...) and  $T$  is the period. The function shown in Fig. 16.1 is periodic because

$$f(t_0) = f(t_0 - T) = f(t_0 + T) = f(t_0 + 2T) = \dots$$

for any arbitrarily chosen value of  $t_0$ . Note that  $T$  is the smallest time interval that a periodic function may be shifted (in either direction) to produce a function that is identical to itself.

Why the interest in periodic functions? One reason is that many electrical sources of practical value generate periodic waveforms. For example, nonfiltered electronic rectifiers driven from a sinusoidal source produces rectified sine waves that are nonsinusoidal, but periodic. Figures 16.2(a) and (b) on page 604 show the waveforms of the full-wave and half-wave sinusoidal rectifiers, respectively.

The sweep generator used to control the electron beam of a cathode-ray oscilloscope produces a periodic triangular wave like the one shown in Fig. 16.3 on page 604.

Electronic oscillators, which are useful in laboratory testing of equipment, are designed to produce nonsinusoidal periodic waveforms. Function generators, which are capable of producing square-wave, triangular-wave, and rectangular-pulse waveforms, are found in most testing laboratories. Figure 16.4 on page 604 illustrates typical waveforms.

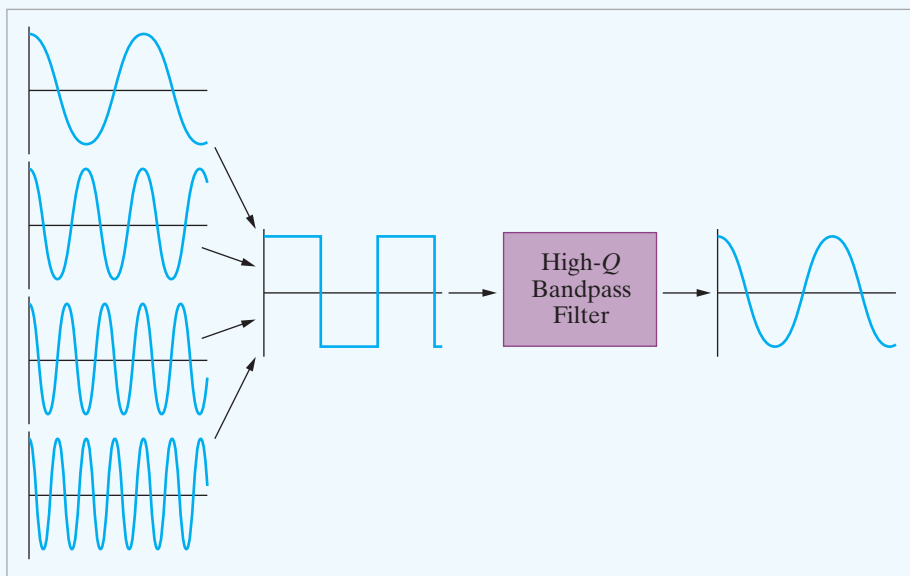
## Practical Perspective

### Active High-Q Filters

In Chapters 14 and 15, we discovered that an important characteristic of bandpass and bandreject filters is the quality factor,  $Q$ . The quality factor provides a measure of how selective the filter is at its center frequency. For example, a bandpass filter with a large value of  $Q$  will amplify signals at or near its center frequency and will attenuate signals at all other frequencies. On the other hand, a bandreject filter with a small value of  $Q$  will not effectively distinguish between signals at the center frequency and signals at frequencies quite different from the center frequency.

In this chapter, we learn that any periodic signal can be represented as a sum of sinusoids, where the frequencies of the

sinusoids in the sum are comprised of the frequency of the periodic signal and integer multiples of that frequency. We can use a periodic signal like a square wave to test the quality factor of a bandpass or bandreject filter. To do this, we choose a square wave whose frequency is the same as the center frequency of a bandpass filter, for example. If the bandpass filter has a high quality factor, its output will be nearly sinusoidal, thereby transforming the input square wave into an output sinusoid. If the filter has a low quality factor, its output will still look like a square wave, as the filter is not able to select from among the sinusoids that make up the input square wave. We present an example at the end of this chapter.



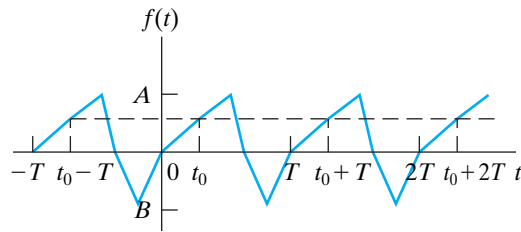


Figure 16.1 ▲ A periodic waveform.

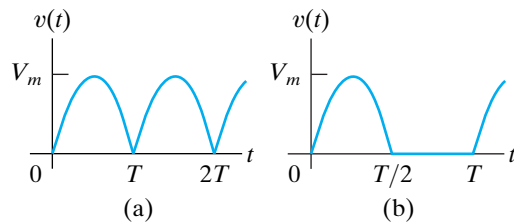


Figure 16.2 ▲ Output waveforms of a nonfiltered sinusoidal rectifier. (a) Full-wave rectification. (b) Half-wave rectification.

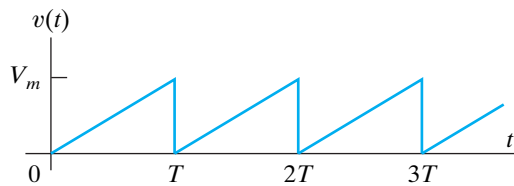


Figure 16.3 ▲ The triangular waveform of a cathode-ray oscilloscope sweep generator.

Another practical problem that stimulates interest in periodic functions is that power generators, although designed to produce a sinusoidal waveform, cannot in practice be made to produce a pure sine wave. The distorted sinusoidal wave, however, is periodic. Engineers naturally are interested in ascertaining the consequences of exciting power systems with a slightly distorted sinusoidal voltage.

Interest in periodic functions also stems from the general observation that any nonlinearity in an otherwise linear circuit creates a nonsinusoidal periodic function. The rectifier circuit alluded to earlier is one example of this phenomenon. Magnetic saturation, which occurs in both machines and transformers, is another example of a nonlinearity that generates a nonsinusoidal periodic function. An electronic clipping circuit, which uses transistor saturation, is yet another example.

Moreover, nonsinusoidal periodic functions are important in the analysis of nonelectrical systems. Problems involving mechanical vibration, fluid flow, and heat flow all make use of periodic functions. In fact, the study and analysis of heat flow in a metal rod led the French mathematician Jean Baptiste Joseph Fourier (1768–1830) to the trigonometric series representation of a periodic function. This series bears his name and is the starting point for finding the steady-state response to periodic excitations of electric circuits.

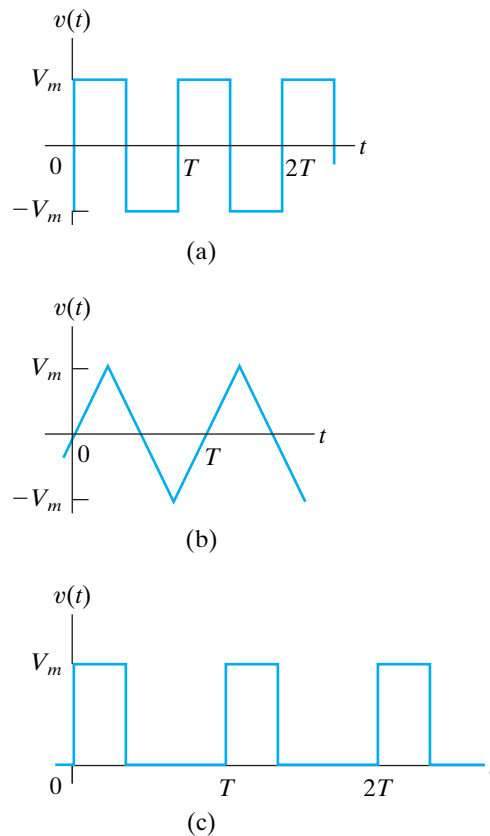


Figure 16.4 ▲ Waveforms produced by function generators used in laboratory testing. (a) Square wave. (b) Triangular wave. (c) Rectangular pulse.



## 16.1 Fourier Series Analysis: An Overview

What Fourier discovered in investigating heat-flow problems is that a periodic function can be represented by an infinite sum of sine or cosine functions that are harmonically related. In other words, the period of any trigonometric term in the infinite series is an integral multiple, or harmonic, of the fundamental period  $T$  of the periodic function. Thus for periodic  $f(t)$ , Fourier showed that  $f(t)$  can be expressed as

$$f(t) = a_v + \sum_{n=1}^{\infty} a_n \cos n\omega_0 t + b_n \sin n\omega_0 t, \quad (16.2)$$

◀ **Fourier series representation of a periodic function**

where  $n$  is the integer sequence  $1, 2, 3, \dots$

In Eq. 16.2,  $a_v$ ,  $a_n$ , and  $b_n$  are known as the **Fourier coefficients** and are calculated from  $f(t)$ . The term  $\omega_0$  (which equals  $2\pi/T$ ) represents the **fundamental frequency** of the periodic function  $f(t)$ . The integral multiples of  $\omega_0$ —that is,  $2\omega_0$ ,  $3\omega_0$ ,  $4\omega_0$ , and so on—are known as the **harmonic frequencies** of  $f(t)$ . Thus  $2\omega_0$  is the second harmonic,  $3\omega_0$  is the third harmonic, and  $n\omega_0$  is the  $n$ th harmonic of  $f(t)$ .

We discuss the determination of the Fourier coefficients in Section 16.2. Before pursuing the details of using a Fourier series in circuit analysis, we first need to look at the process in general terms. From an applications point of view, we can express all the periodic functions of interest in terms of a Fourier series. Mathematically, the conditions on a periodic function  $f(t)$  that ensure expressing  $f(t)$  as a convergent Fourier series (known as **Dirichlet's conditions**) are that

1.  $f(t)$  be single-valued,
2.  $f(t)$  have a finite number of discontinuities in the periodic interval,
3.  $f(t)$  have a finite number of maxima and minima in the periodic interval,
4. the integral

$$\int_{t_0}^{t_0+T} |f(t)| dt$$

exists.

Any periodic function generated by a physically realizable source satisfies Dirichlet's conditions. These are **sufficient** conditions, not **necessary** conditions. Thus if  $f(t)$  meets these requirements, we know that we can express it as a Fourier series. However, if  $f(t)$  does not meet these requirements, we still may be able to express it as a Fourier series. The necessary conditions on  $f(t)$  are not known.

After we have determined  $f(t)$  and calculated the Fourier coefficients ( $a_v$ ,  $a_n$ , and  $b_n$ ), we resolve the periodic source into a dc source ( $a_v$ ) plus a sum of sinusoidal sources ( $a_n$  and  $b_n$ ). Because the periodic source is driving a linear circuit, we may use the principle of superposition to find the steady-state response. In particular, we first calculate the response to each source generated by the Fourier series representation of  $f(t)$  and then add the individual responses to obtain the total response. The steady-state response owing to a specific sinusoidal source is most easily found with the phasor method of analysis.

The procedure is straightforward and involves no new techniques of circuit analysis. It produces the Fourier series representation of the steady-state response; consequently, the actual shape of the response is



unknown. Furthermore, the response waveform can be estimated only by adding a sufficient number of terms together. Even though the Fourier series approach to finding the steady-state response does have some drawbacks, it introduces a way of thinking about a problem that is as important as getting quantitative results. In fact, the conceptual picture is even more important in some respects than the quantitative one.

## 16.2 The Fourier Coefficients

After defining a periodic function over its fundamental period, we determine the Fourier coefficients from the relationships

Fourier coefficients ►

$$a_v = \frac{1}{T} \int_{t_0}^{t_0+T} f(t) dt, \quad (16.3)$$

$$a_k = \frac{2}{T} \int_{t_0}^{t_0+T} f(t) \cos k\omega_0 t dt, \quad (16.4)$$

$$b_k = \frac{2}{T} \int_{t_0}^{t_0+T} f(t) \sin k\omega_0 t dt. \quad (16.5)$$

In Eqs. 16.4 and 16.5, the subscript  $k$  indicates the  $k$ th coefficient in the integer sequence 1, 2, 3, . . . . Note that  $a_v$  is the average value of  $f(t)$ ,  $a_k$  is twice the average value of  $f(t) \cos k\omega_0 t$ , and  $b_k$  is twice the average value of  $f(t) \sin k\omega_0 t$ .

We easily derive Eqs. 16.3–16.5 from Eq. 16.2 by recalling the following integral relationships, which hold when  $m$  and  $n$  are integers:

$$\int_{t_0}^{t_0+T} \sin m\omega_0 t dt = 0, \quad \text{for all } m, \quad (16.6)$$

$$\int_{t_0}^{t_0+T} \cos m\omega_0 t dt = 0, \quad \text{for all } m, \quad (16.7)$$

$$\int_{t_0}^{t_0+T} \cos m\omega_0 t \sin n\omega_0 t dt = 0, \quad \text{for all } m \text{ and } n, \quad (16.8)$$

$$\begin{aligned} \int_{t_0}^{t_0+T} \sin m\omega_0 t \sin n\omega_0 t dt &= 0, \quad \text{for all } m \neq n, \\ &= \frac{T}{2}, \quad \text{for } m = n, \end{aligned} \quad (16.9)$$

$$\begin{aligned} \int_{t_0}^{t_0+T} \cos m\omega_0 t \cos n\omega_0 t dt &= 0, \quad \text{for all } m \neq n, \\ &= \frac{T}{2}, \quad \text{for } m = n. \end{aligned} \quad (16.10)$$

We leave you to verify Eqs. 16.6–16.10 in Problem 16.5.

To derive Eq. 16.3, we simply integrate both sides of Eq. 16.2 over one period:

$$\begin{aligned} \int_{t_0}^{t_0+T} f(t) dt &= \int_{t_0}^{t_0+T} \left( a_v + \sum_{n=1}^{\infty} a_n \cos n\omega_0 t + b_n \sin n\omega_0 t \right) dt \\ &= \int_{t_0}^{t_0+T} a_v dt + \sum_{n=1}^{\infty} \int_{t_0}^{t_0+T} (a_n \cos n\omega_0 t + b_n \sin n\omega_0 t) dt \\ &= a_v T + 0. \end{aligned} \quad (16.11)$$

Equation 16.3 follows directly from Eq. 16.11.

To derive the expression for the  $k$ th value of  $a_n$ , we first multiply Eq. 16.2 by  $\cos k\omega_0 t$  and then integrate both sides over one period of  $f(t)$ :

$$\begin{aligned} \int_{t_0}^{t_0+T} f(t) \cos k\omega_0 t dt &= \int_{t_0}^{t_0+T} a_v \cos k\omega_0 t dt \\ &+ \sum_{n=1}^{\infty} \int_{t_0}^{t_0+T} (a_n \cos n\omega_0 t \cos k\omega_0 t + b_n \sin n\omega_0 t \cos k\omega_0 t) dt \\ &= 0 + a_k \left( \frac{T}{2} \right) + 0. \end{aligned} \quad (16.12)$$

Solving Eq. 16.12 for  $a_k$  yields the expression in Eq. 16.4.

We obtain the expression for the  $k$ th value of  $b_n$  by first multiplying both sides of Eq. 16.2 by  $\sin k\omega_0 t$  and then integrating each side over one period of  $f(t)$ . Example 16.1 shows how to use Eqs. 16.3–16.5 to find the Fourier coefficients for a specific periodic function.

### Example 16.1 Finding the Fourier Series of a Triangular Waveform with No Symmetry

Find the Fourier series for the periodic voltage shown in Fig. 16.5.

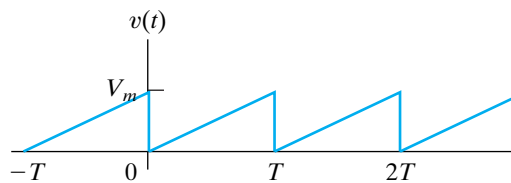


Figure 16.5 ▲ The periodic voltage for Example 16.1.

#### Solution

When using Eqs. 16.3–16.5 to find  $a_v$ ,  $a_k$ , and  $b_k$ , we may choose the value of  $t_0$ . For the periodic voltage of Fig. 16.5, the best choice for  $t_0$  is zero. Any other choice makes the required integrations more cumbersome. The expression for  $v(t)$  between 0 and  $T$  is

$$v(t) = \left( \frac{V_m}{T} \right) t.$$

The equation for  $a_v$  is

$$a_v = \frac{1}{T} \int_0^T \left( \frac{V_m}{T} \right) t dt = \frac{1}{2} V_m.$$

This is clearly the average value of the waveform in Fig. 16.5.

The equation for the  $k$ th value of  $a_n$  is

$$\begin{aligned} a_k &= \frac{2}{T} \int_0^T \left( \frac{V_m}{T} \right) t \cos k\omega_0 t dt \\ &= \frac{2V_m}{T^2} \left( \frac{1}{k^2 \omega_0^2} \cos k\omega_0 t + \frac{t}{k\omega_0} \sin k\omega_0 t \right) \Bigg|_0^T \\ &= \frac{2V_m}{T^2} \left[ \frac{1}{k^2 \omega_0^2} (\cos 2\pi k - 1) \right] = 0 \quad \text{for all } k. \end{aligned}$$

The equation for the  $k$ th value of  $b_n$  is

$$\begin{aligned} b_k &= \frac{2}{T} \int_0^T \left( \frac{V_m}{T} \right) t \sin k\omega_0 t \, dt \\ &= \frac{2V_m}{T^2} \left( \frac{1}{k^2\omega_0^2} \sin k\omega_0 t - \frac{t}{k\omega_0} \cos k\omega_0 t \right) \Big|_0^T \\ &= \frac{2V_m}{T^2} \left( 0 - \frac{T}{k\omega_0} \cos 2\pi k \right) \\ &= \frac{-V_m}{\pi k}. \end{aligned}$$

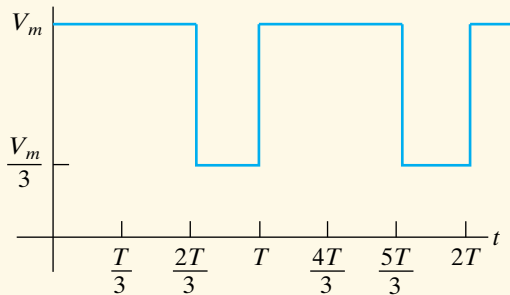
The Fourier series for  $v(t)$  is

$$\begin{aligned} v(t) &= \frac{V_m}{2} - \frac{V_m}{\pi} \sum_{n=1}^{\infty} \frac{1}{n} \sin n\omega_0 t \\ &= \frac{V_m}{2} - \frac{V_m}{\pi} \sin \omega_0 t - \frac{V_m}{2\pi} \sin 2\omega_0 t - \frac{V_m}{3\pi} \sin 3\omega_0 t - \dots \end{aligned}$$

## ASSESSMENT PROBLEMS

**Objective 1**—Be able to calculate the trigonometric form of the Fourier coefficients for a periodic waveform

**16.1** Derive the expressions for  $a_v$ ,  $a_k$ , and  $b_k$  for the periodic voltage function shown if  $V_m = 9\pi$  V.



**Answer:**  $a_v = 21.99$  V,

$$a_k = \frac{6}{k} \sin \frac{4k\pi}{3} \text{ V},$$

$$b_k = \frac{6}{k} (1 - \cos \frac{4k\pi}{3}) \text{ V}.$$

**NOTE:** Also try Chapter Problems 16.1–16.3.

**16.2** Refer to Assessment Problem 16.1.

- What is the average value of the periodic voltage?
- Compute the numerical values of  $a_1 - a_5$  and  $b_1 - b_5$ .
- If  $T = 125.66$  ms, what is the fundamental frequency in radians per second?
- What is the frequency of the third harmonic in hertz?
- Write the Fourier series up to and including the fifth harmonic.

**Answer:** (a) 21.99 V;  
 (b)  $-5.2$  V, 2.6 V, 0 V,  $-1.3$ , and 1.04 V;  
 9 V, 4.5 V, 0 V, 2.25 V, and 1.8 V;  
 (c) 50 rad/s;  
 (d) 23.87 Hz;  
 (e)  $v(t) = 21.99 - 5.2 \cos 50t + 9 \sin 50t + 2.6 \cos 100t + 4.5 \sin 100t - 1.3 \cos 200t + 2.25 \sin 200t + 1.04 \cos 250t + 1.8 \sin 250t$  V.

Finding the Fourier coefficients, in general, is tedious. Therefore anything that simplifies the task is beneficial. Fortunately, a periodic function that possesses certain types of symmetry greatly reduces the amount of work involved in finding the coefficients. In Section 16.3, we discuss how symmetry affects the coefficients in a Fourier series.

## 16.3 The Effect of Symmetry on the Fourier Coefficients

Four types of symmetry may be used to simplify the task of evaluating the Fourier coefficients:

- even-function symmetry,
- odd-function symmetry,
- half-wave symmetry,
- quarter-wave symmetry.

The effect of each type of symmetry on the Fourier coefficients is discussed in the following sections.

### Even-Function Symmetry

A function is defined as even if

$$f(t) = f(-t). \quad (16.13) \quad \blacktriangleleft \text{Even function}$$

Functions that satisfy Eq. 16.13 are said to be even because polynomial functions with only even exponents possess this characteristic. For even periodic functions, the equations for the Fourier coefficients reduce to

$$a_v = \frac{2}{T} \int_0^{T/2} f(t) dt, \quad (16.14)$$

$$a_k = \frac{4}{T} \int_0^{T/2} f(t) \cos k\omega_0 t dt, \quad (16.15)$$

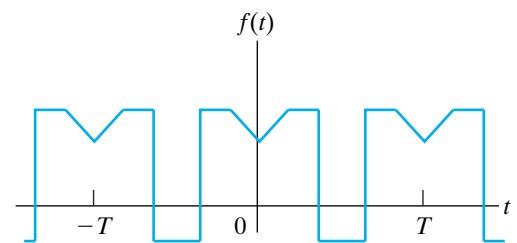
$$b_k = 0, \quad \text{for all } k. \quad (16.16)$$

Note that all the  $b$  coefficients are zero if the periodic function is even. Figure 16.6 illustrates an even periodic function. The derivations of Eqs. 16.14–16.16 follow directly from Eqs. 16.3–16.5. In each derivation, we select  $t_0 = -T/2$  and then break the interval of integration into the range from  $-T/2$  to 0 and 0 to  $T/2$ , or

$$\begin{aligned} a_v &= \frac{1}{T} \int_{-T/2}^{T/2} f(t) dt \\ &= \frac{1}{T} \int_{-T/2}^0 f(t) dt + \frac{1}{T} \int_0^{T/2} f(t) dt. \end{aligned} \quad (16.17)$$

Now we change the variable of integration in the first integral on the right-hand side of Eq. 16.17. Specifically, we let  $t = -x$  and note that  $f(t) = f(-x) = f(x)$  because the function is even. We also observe that  $x = T/2$  when  $t = -T/2$  and  $dt = -dx$ . Then

$$\int_{-T/2}^0 f(t) dt = \int_{T/2}^0 f(x)(-dx) = \int_0^{T/2} f(x) dx, \quad (16.18)$$



**Figure 16.6** ▲ An even periodic function,  $f(t) = f(-t)$ .

which shows that the integration from  $-T/2$  to 0 is identical to that from 0 to  $T/2$ ; therefore Eq. 16.17 is the same as Eq. 16.14. The derivation of Eq. 16.15 proceeds along similar lines. Here,

$$a_k = \frac{2}{T} \int_{-T/2}^0 f(t) \cos k\omega_0 t \, dt + \frac{2}{T} \int_0^{T/2} f(t) \cos k\omega_0 t \, dt, \tag{16.19}$$

but

$$\begin{aligned} \int_{-T/2}^0 f(t) \cos k\omega_0 t \, dt &= \int_{T/2}^0 f(x) \cos(-k\omega_0 x)(-dx) \\ &= \int_0^{T/2} f(x) \cos k\omega_0 x \, dx. \end{aligned} \tag{16.20}$$

As before, the integration from  $-T/2$  to 0 is identical to that from 0 to  $T/2$ . Combining Eq. 16.20 with Eq. 16.19 yields Eq. 16.15.

All the  $b$  coefficients are zero when  $f(t)$  is an even periodic function, because the integration from  $-T/2$  to 0 is the exact negative of the integration from 0 to  $T/2$ ; that is,

$$\begin{aligned} \int_{-T/2}^0 f(t) \sin k\omega_0 t \, dt &= \int_{T/2}^0 f(x) \sin(-k\omega_0 x)(-dx) \\ &= - \int_0^{T/2} f(x) \sin k\omega_0 x \, dx. \end{aligned} \tag{16.21}$$

When we use Eqs. 16.14 and 16.15 to find the Fourier coefficients, the interval of integration must be between 0 and  $T/2$ .

### Odd-Function Symmetry

A function is defined as odd if

**Odd function** ►

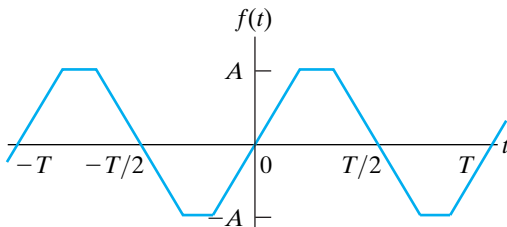
$$f(t) = -f(-t). \tag{16.22}$$

Functions that satisfy Eq. 16.22 are said to be odd because polynomial functions with only odd exponents have this characteristic. The expressions for the Fourier coefficients are

$$a_v = 0; \tag{16.23}$$

$$a_k = 0, \quad \text{for all } k; \tag{16.24}$$

$$b_k = \frac{4}{T} \int_0^{T/2} f(t) \sin k\omega_0 t \, dt. \tag{16.25}$$



**Figure 16.7** ▲ An odd periodic function  $f(t) = -f(-t)$ .

Note that all the  $a$  coefficients are zero if the periodic function is odd. Figure 16.7 shows an odd periodic function.

We use the same process to derive Eqs. 16.23–16.25 that we used to derive Eqs. 16.14–16.16. We leave the derivations to you in Problem 16.7.

The evenness, or oddness, of a periodic function can be destroyed by shifting the function along the time axis. In other words, the judicious choice of where  $t = 0$  may give a periodic function even or odd symmetry. For example, the triangular function shown in Fig. 16.8(a) is neither even nor odd. However, we can make the function even, as shown in Fig. 16.8(b), or odd, as shown in Fig. 16.8(c).

### Half-Wave Symmetry

A periodic function possesses half-wave symmetry if it satisfies the constraint

$$f(t) = -f(t - T/2). \quad (16.26)$$

Equation 16.26 states that a periodic function has half-wave symmetry if, after it is shifted one-half period and inverted, it is identical to the original function. For example, the functions shown in Figs. 16.7 and 16.8 have half-wave symmetry, whereas those in Figs. 16.5 and 16.6 do not. Note that half-wave symmetry is not a function of where  $t = 0$ .

If a periodic function has half-wave symmetry, both  $a_k$  and  $b_k$  are zero for even values of  $k$ . Moreover,  $a_v$  also is zero because the average value of a function with half-wave symmetry is zero. The expressions for the Fourier coefficients are

$$a_v = 0, \quad (16.27)$$

$$a_k = 0, \quad \text{for } k \text{ even}; \quad (16.28)$$

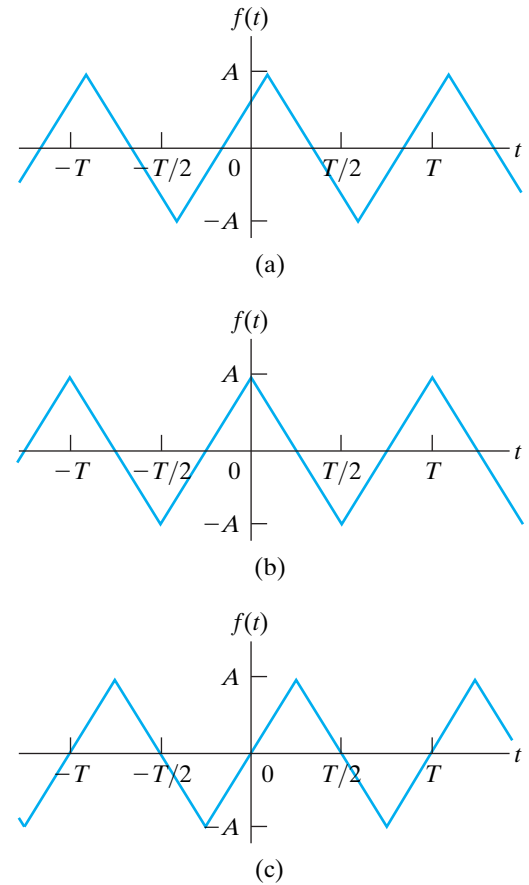
$$a_k = \frac{4}{T} \int_0^{T/2} f(t) \cos k\omega_0 t \, dt, \quad \text{for } k \text{ odd}; \quad (16.29)$$

$$b_k = 0, \quad \text{for } k \text{ even}; \quad (16.30)$$

$$b_k = \frac{4}{T} \int_0^{T/2} f(t) \sin k\omega_0 t \, dt, \quad \text{for } k \text{ odd}. \quad (16.31)$$

We derive Eqs. 16.27–16.31 by starting with Eqs. 16.3–16.5 and choosing the interval of integration as  $-T/2$  to  $T/2$ . We then divide this range into the intervals  $-T/2$  to 0 and 0 to  $T/2$ . For example, the derivation for  $a_k$  is

$$\begin{aligned} a_k &= \frac{2}{T} \int_{t_0}^{t_0+T} f(t) \cos k\omega_0 t \, dt \\ &= \frac{2}{T} \int_{-T/2}^{T/2} f(t) \cos k\omega_0 t \, dt \\ &= \frac{2}{T} \int_{-T/2}^0 f(t) \cos k\omega_0 t \, dt \\ &\quad + \frac{2}{T} \int_0^{T/2} f(t) \cos k\omega_0 t \, dt. \end{aligned} \quad (16.32)$$



**Figure 16.8** ▲ How the choice of where  $t = 0$  can make a periodic function even, odd, or neither. (a) A periodic triangular wave that is neither even nor odd. (b) The triangular wave of (a) made even by shifting the function along the  $t$  axis. (c) The triangular wave of (a) made odd by shifting the function along the  $t$  axis.

Now we change a variable in the first integral on the right-hand side of Eq. 16.32. Specifically, we let

$$t = x - T/2.$$

Then

$$x = T/2, \quad \text{when } t = 0;$$

$$x = 0, \quad \text{when } t = -T/2;$$

$$dt = dx.$$

We rewrite the first integral as

$$\int_{-T/2}^0 f(t) \cos k\omega_0 t \, dt = \int_0^{T/2} f(x - T/2) \cos k\omega_0(x - T/2) \, dx. \quad (16.33)$$

Note that

$$\cos k\omega_0(x - T/2) = \cos(k\omega_0 x - k\pi) = \cos k\pi \cos k\omega_0 x$$

and that, by hypothesis,

$$f(x - T/2) = -f(x).$$

Therefore Eq. 16.33 becomes

$$\int_{-T/2}^0 f(t) \cos k\omega_0 t \, dt = \int_0^{T/2} [-f(x)] \cos k\pi \cos k\omega_0 x \, dx. \quad (16.34)$$

Incorporating Eq. 16.34 into Eq. 16.32 gives

$$a_k = \frac{2}{T}(1 - \cos k\pi) \int_0^{T/2} f(t) \cos k\omega_0 t \, dt. \quad (16.35)$$

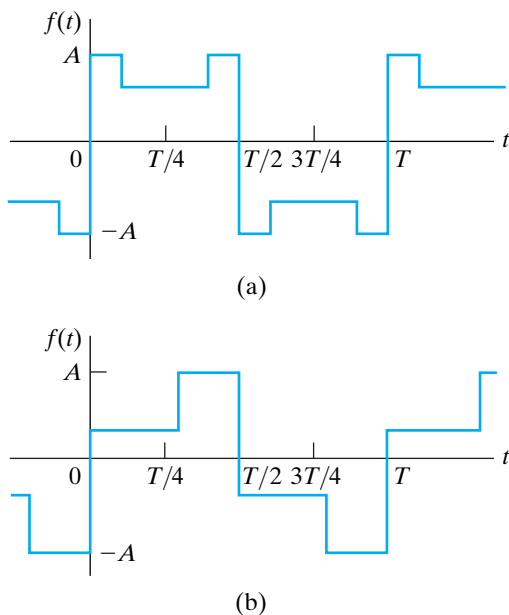
But  $\cos k\pi$  is 1 when  $k$  is even and  $-1$  when  $k$  is odd. Therefore Eq. 16.35 generates Eqs. 16.28 and 16.29.

We leave it to you to verify that this same process can be used to derive Eqs. 16.30 and 16.31 (see Problem 16.8).

We summarize our observations by noting that the Fourier series representation of a periodic function with half-wave symmetry has zero average, or dc, value and contains only odd harmonics.

### Quarter-Wave Symmetry

The term **quarter-wave symmetry** describes a periodic function that has half-wave symmetry and, in addition, symmetry about the midpoint of the positive and negative half-cycles. The function illustrated in Fig. 16.9(a)



**Figure 16.9** ▲ (a) A function that has quarter-wave symmetry. (b) A function that does not have quarter-wave symmetry.



has quarter-wave symmetry about the midpoint of the positive and negative half-cycles. The function in Fig. 16.9(b) does not have quarter-wave symmetry, although it does have half-wave symmetry.

A periodic function that has quarter-wave symmetry can always be made either even or odd by the proper choice of the point where  $t = 0$ . For example, the function shown in Fig. 16.9(a) is odd and can be made even by shifting the function  $T/4$  units either right or left along the  $t$  axis. However, the function in Fig. 16.9(b) can never be made either even or odd. To take advantage of quarter-wave symmetry in the calculation of the Fourier coefficients, you must choose the point where  $t = 0$  to make the function either even or odd.

If the function is made even, then

$$a_v = 0, \text{ because of half-wave symmetry;}$$

$$a_k = 0, \text{ for } k \text{ even, because of half-wave symmetry;}$$

$$a_k = \frac{8}{T} \int_0^{T/4} f(t) \cos k\omega_0 t \, dt, \quad \text{for } k \text{ odd;}$$

$$b_k = 0, \text{ for all } k, \text{ because the function is even.} \quad (16.36)$$

Equations 16.36 result from the function's quarter-wave symmetry in addition to its being even. Recall that quarter-wave symmetry is superimposed on half-wave symmetry, so we can eliminate  $a_v$  and  $a_k$  for  $k$  even. Comparing the expression for  $a_k$ ,  $k$  odd, in Eqs. 16.36 with Eq. 16.29 shows that combining quarter-wave symmetry with evenness allows the shortening of the range of integration from 0 to  $T/2$  to 0 to  $T/4$ . We leave the derivation of Eqs. 16.36 to you in Problem 16.9.

If the quarter-wave symmetric function is made odd,

$$a_v = 0, \text{ because the function is odd;}$$

$$a_k = 0, \text{ for all } k, \text{ because the function is odd;}$$

$$b_k = 0, \text{ for } k \text{ even, because of half-wave symmetry;}$$

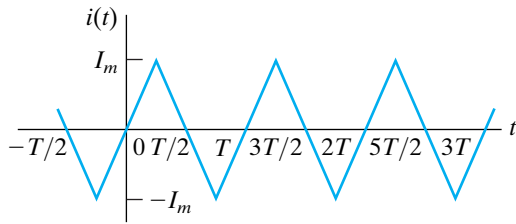
$$b_k = \frac{8}{T} \int_0^{T/4} f(t) \sin k\omega_0 t \, dt, \quad \text{for } k \text{ odd.} \quad (16.37)$$

Equations 16.37 are a direct consequence of quarter-wave symmetry and oddness. Again, quarter-wave symmetry allows the shortening of the interval of integration from 0 to  $T/2$  to 0 to  $T/4$ . We leave the derivation of Eqs. 16.37 to you in Problem 16.10.

Example 16.2 shows how to use symmetry to simplify the task of finding the Fourier coefficients.

**Example 16.2** Finding the Fourier Series of an Odd Function with Symmetry

Find the Fourier series representation for the current waveform shown in Fig. 16.10.



**Figure 16.10** ▲ The periodic waveform for Example 16.2.

**Solution**

We begin by looking for degrees of symmetry in the waveform. We find that the function is odd and, in addition, has half-wave and quarter-wave symmetry. Because the function is odd, all the  $a$  coefficients are zero; that is,  $a_0 = 0$  and  $a_k = 0$  for all  $k$ . Because the function has half-wave symmetry,  $b_k = 0$  for even values of  $k$ . Because the function has quarter-wave symmetry, the expression for  $b_k$  for odd values of  $k$  is

$$b_k = \frac{8}{T} \int_0^{T/4} i(t) \sin k\omega_0 t \, dt.$$

In the interval  $0 \leq t \leq T/4$ , the expression for  $i(t)$  is

$$i(t) = \frac{4I_m}{T} t.$$

Thus

$$\begin{aligned} b_k &= \frac{8}{T} \int_0^{T/4} \frac{4I_m}{T} t \sin k\omega_0 t \, dt \\ &= \frac{32I_m}{T^2} \left( \frac{\sin k\omega_0 t}{k^2\omega_0^2} - \frac{t \cos k\omega_0 t}{k\omega_0} \right) \Big|_0^{T/4} \\ &= \frac{8I_m}{\pi^2 k^2} \sin \frac{k\pi}{2} \quad (k \text{ is odd}). \end{aligned}$$

The Fourier series representation of  $i(t)$  is

$$\begin{aligned} i(t) &= \frac{8I_m}{\pi^2} \sum_{n=1,3,5,\dots}^{\infty} \frac{1}{n^2} \sin \frac{n\pi}{2} \sin n\omega_0 t \\ &= \frac{8I_m}{\pi^2} \left( \sin \omega_0 t - \frac{1}{9} \sin 3\omega_0 t \right. \\ &\quad \left. + \frac{1}{25} \sin 5\omega_0 t - \frac{1}{49} \sin 7\omega_0 t + \dots \right). \end{aligned}$$

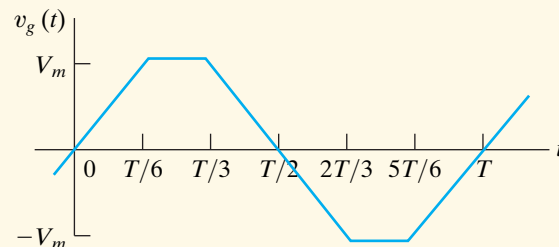
**ASSESSMENT PROBLEM**

**Objective 1**—Be able to calculate the trigonometric form of the Fourier coefficients for a periodic waveform

**16.3** Derive the Fourier series for the periodic voltage shown.

**Answer:** 
$$v_g(t) = \frac{12V_m}{\pi^2} \sum_{n=1,3,5,\dots}^{\infty} \frac{\sin(n\pi/3)}{n^2} \sin n\omega_0 t.$$

*NOTE:* Also try Chapter Problems 16.11 and 16.12.



## 16.4 An Alternative Trigonometric Form of the Fourier Series

In circuit applications of the Fourier series, we combine the cosine and sine terms in the series into a single term for convenience. Doing so allows the representation of each harmonic of  $v(t)$  or  $i(t)$  as a single phasor quantity. The cosine and sine terms may be merged in either a cosine expression or a sine expression. Because we chose the cosine format in the phasor method of analysis (see Chapter 9), we choose the cosine expression here for the alternative form of the series. Thus we write the Fourier series in Eq. 16.2 as

$$f(t) = a_v + \sum_{n=1}^{\infty} A_n \cos(n\omega_0 t - \theta_n), \quad (16.38)$$

where  $A_n$  and  $\theta_n$  are defined by the complex quantity

$$a_n - jb_n = \sqrt{a_n^2 + b_n^2} \angle -\theta_n = A_n \angle -\theta_n. \quad (16.39)$$

We derive Eqs. 16.38 and 16.39 using the phasor method to add the cosine and sine terms in Eq. 16.2. We begin by expressing the sine functions as cosine functions; that is, we rewrite Eq. 16.2 as

$$f(t) = a_v + \sum_{n=1}^{\infty} a_n \cos n\omega_0 t + b_n \cos(n\omega_0 t - 90^\circ). \quad (16.40)$$

Adding the terms under the summation sign by using phasors gives

$$\mathcal{P}\{a_n \cos n\omega_0 t\} = a_n \angle 0^\circ \quad (16.41)$$

and

$$\mathcal{P}\{b_n \cos(n\omega_0 t - 90^\circ)\} = b_n \angle -90^\circ = -jb_n. \quad (16.42)$$

Then

$$\begin{aligned} \mathcal{P}\{a_n \cos(n\omega_0 t) + b_n \cos(n\omega_0 t - 90^\circ)\} &= a_n - jb_n \\ &= \sqrt{a_n^2 + b_n^2} \angle -\theta_n \\ &= A_n \angle -\theta_n. \end{aligned} \quad (16.43)$$

When we inverse-transform Eq. 16.43, we get

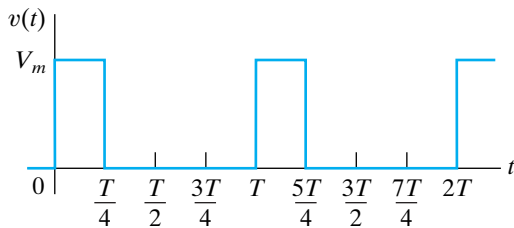
$$\begin{aligned} a_n \cos n\omega_0 t + b_n \cos(n\omega_0 t - 90^\circ) &= \mathcal{P}^{-1}\{A_n \angle -\theta_n\} \\ &= A_n \cos(n\omega_0 t - \theta_n). \end{aligned} \quad (16.44)$$

Substituting Eq. 16.44 into Eq. 16.40 yields Eq. 16.38. Equation 16.43 corresponds to Eq. 16.39. If the periodic function is either even or odd,  $A_n$  reduces to either  $a_n$  (even) or  $b_n$  (odd), and  $\theta_n$  is either  $0^\circ$  (even) or  $90^\circ$  (odd).

The derivation of the alternative form of the Fourier series for a given periodic function is illustrated in Example 16.3.

**Example 16.3** Calculating Forms of the Trigonometric Fourier Series for Periodic Voltage

- a) Derive the expressions for  $a_k$  and  $b_k$  for the periodic function shown in Fig. 16.11.
- b) Write the first four terms of the Fourier series representation of  $v(t)$  using the format of Eq. 16.38.



**Figure 16.11** ▲ The periodic function for Example 16.3.

**Solution**

- a) The voltage  $v(t)$  is neither even nor odd, nor does it have half-wave symmetry. Therefore we use Eqs. 16.4 and 16.5 to find  $a_k$  and  $b_k$ . Choosing  $t_0$  as zero, we obtain

$$\begin{aligned} a_k &= \frac{2}{T} \left[ \int_0^{T/4} V_m \cos k\omega_0 t \, dt + \int_{T/4}^T (0) \cos k\omega_0 t \, dt \right] \\ &= \frac{2V_m}{T} \left. \frac{\sin k\omega_0 t}{k\omega_0} \right|_0^{T/4} = \frac{V_m}{k\pi} \sin \frac{k\pi}{2} \end{aligned}$$

and

$$\begin{aligned} b_k &= \frac{2}{T} \int_0^{T/4} V_m \sin k\omega_0 t \, dt \\ &= \frac{2V_m}{T} \left. \left( \frac{-\cos k\omega_0 t}{k\omega_0} \right) \right|_0^{T/4} \\ &= \frac{V_m}{k\pi} \left( 1 - \cos \frac{k\pi}{2} \right). \end{aligned}$$

- b) The average value of  $v(t)$  is

$$a_v = \frac{V_m(T/4)}{T} = \frac{V_m}{4}.$$

The values of  $a_k - jb_k$  for  $k = 1, 2,$  and  $3$  are

$$a_1 - jb_1 = \frac{V_m}{\pi} - j \frac{V_m}{\pi} = \frac{\sqrt{2}V_m}{\pi} \angle -45^\circ,$$

$$a_2 - jb_2 = 0 - j \frac{V_m}{\pi} = \frac{V_m}{\pi} \angle -90^\circ,$$

$$a_3 - jb_3 = \frac{-V_m}{3\pi} - j \frac{V_m}{3\pi} = \frac{\sqrt{2}V_m}{3\pi} \angle -135^\circ.$$

Thus the first four terms in the Fourier series representation of  $v(t)$  are

$$\begin{aligned} v(t) &= \frac{V_m}{4} + \frac{\sqrt{2}V_m}{\pi} \cos(\omega_0 t - 45^\circ) + \frac{V_m}{\pi} \cos(2\omega_0 t - 90^\circ) \\ &\quad + \frac{\sqrt{2}V_m}{3\pi} \cos(3\omega_0 t - 135^\circ) + \dots \end{aligned}$$

**ASSESSMENT PROBLEM**

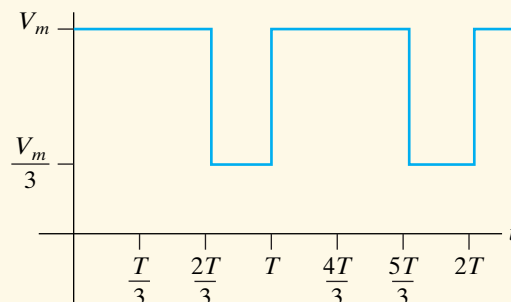
**Objective 1**—Be able to calculate the trigonometric form of the Fourier coefficients for a periodic waveform

- 16.4** a) Compute  $A_1$ – $A_5$  and  $\theta_1$ – $\theta_5$  for the periodic function shown if  $V_m = 9\pi$  V.
- b) Using the format of Eq. 16.38, write the Fourier series for  $v(t)$  up to and including the fifth harmonic assuming  $T = 125.66$  ms.

**Answer:** (a) 10.4, 5.2, 0, 2.6, 2.1 V, and  $-120^\circ$ ,  $-60^\circ$ , not defined,  $-120^\circ$ ,  $-60^\circ$ ;

(b)  $v(t) = 21.99 + 10.4 \cos(50t - 120^\circ) + 5.2 \cos(100t - 60^\circ) + 2.6 \cos(200t - 120^\circ) + 2.1 \cos(250t - 60^\circ)$  V.

**NOTE:** Also try Chapter Problem 16.22.



## 16.5 An Application

Now we illustrate how to use a Fourier series representation of a periodic excitation function to find the steady-state response of a linear circuit. The  $RC$  circuit shown in Fig. 16.12(a) will provide our example. The circuit is energized with the periodic square-wave voltage shown in Fig. 16.12(b). The voltage across the capacitor is the desired response, or output, signal.

The first step in finding the steady-state response is to represent the periodic excitation source with its Fourier series. After noting that the source has odd, half-wave, and quarter-wave symmetry, we know that the Fourier coefficients reduce to  $b_k$ , with  $k$  restricted to odd integer values:

$$\begin{aligned} b_k &= \frac{8}{T} \int_0^{T/4} V_m \sin k\omega_0 t \, dt \\ &= \frac{4V_m}{\pi k} \quad (k \text{ is odd}). \end{aligned} \quad (16.45)$$

Then the Fourier series representation of  $v_g$  is

$$v_g = \frac{4V_m}{\pi} \sum_{n=1,3,5,\dots}^{\infty} \frac{1}{n} \sin n\omega_0 t. \quad (16.46)$$

Writing the series in expanded form, we have

$$\begin{aligned} v_g &= \frac{4V_m}{\pi} \sin \omega_0 t + \frac{4V_m}{3\pi} \sin 3\omega_0 t \\ &+ \frac{4V_m}{5\pi} \sin 5\omega_0 t + \frac{4V_m}{7\pi} \sin 7\omega_0 t + \dots \end{aligned} \quad (16.47)$$

The voltage source expressed by Eq. 16.47 is the equivalent of infinitely many series-connected sinusoidal sources, each source having its own amplitude and frequency. To find the contribution of each source to the output voltage, we use the principle of superposition.

For any one of the sinusoidal sources, the phasor-domain expression for the output voltage is

$$\mathbf{V}_o = \frac{\mathbf{V}_g}{1 + j\omega RC}. \quad (16.48)$$

All the voltage sources are expressed as sine functions, so we interpret a phasor in terms of the sine instead of the cosine. In other words, when we go from the phasor domain back to the time domain, we simply write the time-domain expressions as  $\sin(\omega t + \theta)$  instead of  $\cos(\omega t + \theta)$ .

The phasor output voltage owing to the fundamental frequency of the sinusoidal source is

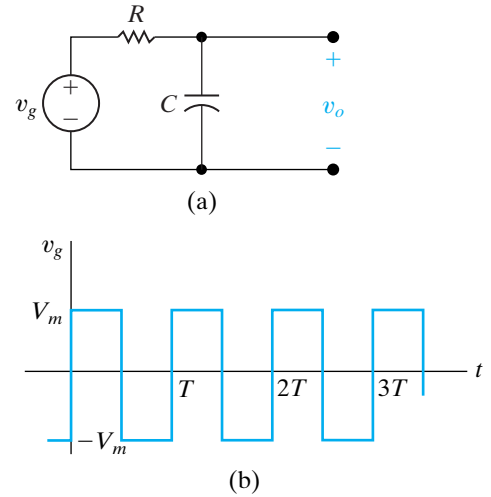
$$\mathbf{V}_{o1} = \frac{(4V_m/\pi) \angle 0^\circ}{1 + j\omega_0 RC}. \quad (16.49)$$

Writing  $\mathbf{V}_{o1}$  in polar form gives

$$\mathbf{V}_{o1} = \frac{(4V_m) \angle -\beta_1}{\pi \sqrt{1 + \omega_0^2 R^2 C^2}}, \quad (16.50)$$

where

$$\beta_1 = \tan^{-1} \omega_0 RC. \quad (16.51)$$



**Figure 16.12** ▲ An  $RC$  circuit excited by a periodic voltage. (a) The  $RC$  series circuit. (b) The square-wave voltage.

From Eq. 16.50, the time-domain expression for the fundamental frequency component of  $v_o$  is

$$v_{o1} = \frac{4V_m}{\pi\sqrt{1 + \omega_0^2 R^2 C^2}} \sin(\omega_0 t - \beta_1). \quad (16.52)$$

We derive the third-harmonic component of the output voltage in a similar manner. The third-harmonic phasor voltage is

$$\begin{aligned} \mathbf{V}_{o3} &= \frac{(4V_m/3\pi) \angle 0^\circ}{1 + j3\omega_0 RC} \\ &= \frac{4V_m}{3\pi\sqrt{1 + 9\omega_0^2 R^2 C^2}} \angle -\beta_3, \end{aligned} \quad (16.53)$$

where

$$\beta_3 = \tan^{-1} 3\omega_0 RC. \quad (16.54)$$

The time-domain expression for the third-harmonic output voltage is

$$v_{o3} = \frac{4V_m}{3\pi\sqrt{1 + 9\omega_0^2 R^2 C^2}} \sin(3\omega_0 t - \beta_3). \quad (16.55)$$

Hence the expression for the  $k$ th-harmonic component of the output voltage is

$$v_{ok} = \frac{4V_m}{k\pi\sqrt{1 + k^2\omega_0^2 R^2 C^2}} \sin(k\omega_0 t - \beta_k) \quad (k \text{ is odd}), \quad (16.56)$$

where

$$\beta_k = \tan^{-1} k\omega_0 RC \quad (k \text{ is odd}). \quad (16.57)$$

We now write down the Fourier series representation of the output voltage:

$$v_o(t) = \frac{4V_m}{\pi} \sum_{n=1,3,5,\dots}^{\infty} \frac{\sin(n\omega_0 t - \beta_n)}{n\sqrt{1 + (n\omega_0 RC)^2}}. \quad (16.58)$$

The derivation of Eq. 16.58 was not difficult. But, although we have an analytic expression for the steady-state output, what  $v_o(t)$  looks like is not immediately apparent from Eq. 16.58. As we mentioned earlier, this shortcoming is a problem with the Fourier series approach. Equation 16.58 is not useless, however, because it gives some feel for the steady-state waveform of  $v_o(t)$ , if we focus on the frequency response of the circuit. For example, if  $C$  is large,  $1/n\omega_0 C$  is small for the higher order harmonics. Thus the capacitor short circuits the high-frequency components of the input waveform, and the higher order harmonics in Eq. 16.58 are negligible compared to the lower order harmonics. Equation 16.58 reflects this condition in that, for large  $C$ ,

$$\begin{aligned} v_o &\approx \frac{4V_m}{\pi\omega_0 RC} \sum_{n=1,3,5,\dots}^{\infty} \frac{1}{n^2} \sin(n\omega_0 t - 90^\circ) \\ &\approx \frac{-4V_m}{\pi\omega_0 RC} \sum_{n=1,3,5,\dots}^{\infty} \frac{1}{n^2} \cos n\omega_0 t. \end{aligned} \quad (16.59)$$

Equation 16.59 shows that the amplitude of the harmonic in the output is decreasing by  $1/n^2$ , compared with  $1/n$  for the input harmonics. If  $C$  is so large that only the fundamental component is significant, then to a first approximation

$$v_o(t) \approx \frac{-4V_m}{\pi\omega_0 RC} \cos \omega_0 t, \quad (16.60)$$

and Fourier analysis tells us that the square-wave input is deformed into a sinusoidal output.

Now let's see what happens as  $C \rightarrow 0$ . The circuit shows that  $v_o$  and  $v_g$  are the same when  $C = 0$ , because the capacitive branch looks like an open circuit at all frequencies. Equation 16.58 predicts the same result because, as  $C \rightarrow 0$ ,

$$v_o = \frac{4V_m}{\pi} \sum_{n=1,3,5,\dots}^{\infty} \frac{1}{n} \sin n\omega_0 t. \quad (16.61)$$

But Eq. 16.61 is identical to Eq. 16.46, and therefore  $v_o \rightarrow v_g$  as  $C \rightarrow 0$ .

Thus Eq. 16.58 has proven useful because it enabled us to predict that the output will be a highly distorted replica of the input waveform if  $C$  is large, and a reasonable replica if  $C$  is small. In Chapter 13, we looked at the distortion between the input and output in terms of how much memory the system weighting function had. In the frequency domain, we look at the distortion between the steady-state input and output in terms of how the amplitude and phase of the harmonics are altered as they are transmitted through the circuit. When the network significantly alters the amplitude and phase relationships among the harmonics at the output relative to that at the input, the output is a distorted version of the input. Thus, in the frequency domain, we speak of amplitude distortion and phase distortion.

For the circuit here, amplitude distortion is present because the amplitudes of the input harmonics decrease as  $1/n$ , whereas the amplitudes of the output harmonics decrease as

$$\frac{1}{n} \frac{1}{\sqrt{1 + (n\omega_0 RC)^2}}.$$

This circuit also exhibits phase distortion because the phase angle of each input harmonic is zero, whereas that of the  $n$ th harmonic in the output signal is  $-\tan^{-1} n\omega_0 RC$ .

## An Application of the Direct Approach to the Steady-State Response

For the simple  $RC$  circuit shown in Fig. 16.12(a), we can derive the expression for the steady-state response without resorting to the Fourier series representation of the excitation function. Doing this extra analysis here adds to our understanding of the Fourier series approach.

To find the steady-state expression for  $v_o$  by straightforward circuit analysis, we reason as follows. The square-wave excitation function alternates between charging the capacitor toward  $+V_m$  and  $-V_m$ . After the circuit reaches steady-state operation, this alternate charging becomes periodic. We know from the analysis of the single time-constant  $RC$  circuit (Chapter 7) that the response to abrupt changes in the driving voltage is exponential. Thus the steady-state waveform of the voltage across the capacitor in the circuit shown in Fig. 16.12(a) is as shown in Fig. 16.13.

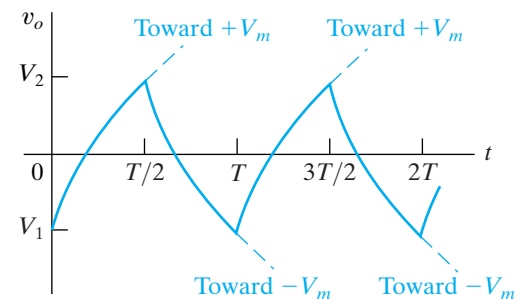
The analytic expressions for  $v_o(t)$  in the time intervals  $0 \leq t \leq T/2$  and  $T/2 \leq t \leq T$  are

$$v_o = V_m + (V_1 - V_m)e^{-t/RC}, \quad 0 \leq t \leq T/2; \quad (16.62)$$

$$v_o = -V_m + (V_2 + V_m)e^{-[t-(T/2)]/RC}, \quad T/2 \leq t \leq T. \quad (16.63)$$

We derive Eqs. 16.62 and 16.63 by using the methods of Chapter 7, as summarized by Eq. 7.60. We obtain the values of  $V_1$  and  $V_2$  by noting from Eq. 16.62 that

$$V_2 = V_m + (V_1 - V_m)e^{-T/2RC}, \quad (16.64)$$



**Figure 16.13** ▲ The steady-state waveform of  $v_o$  for the circuit in Fig. 16.12(a).



and from Eq. 16.63 that

$$V_1 = -V_m + (V_2 + V_m)e^{-T/2RC}. \quad (16.65)$$

Solving Eqs. 16.64 and 16.65 for  $V_1$  and  $V_2$  yields

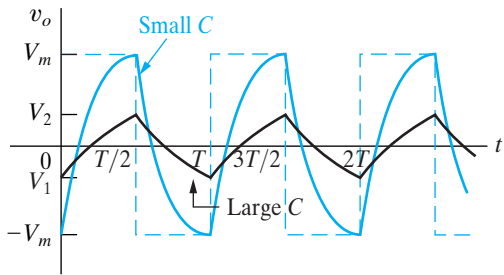
$$V_2 = -V_1 = \frac{V_m(1 - e^{-T/2RC})}{1 + e^{-T/2RC}}. \quad (16.66)$$

Substituting Eq. 16.66 into Eqs. 16.62 and 16.63 gives

$$v_o = V_m - \frac{2V_m}{1 + e^{-T/2RC}}e^{-t/RC}, \quad 0 \leq t \leq T/2, \quad (16.67)$$

and

$$v_o = -V_m + \frac{2V_m}{1 + e^{-T/2RC}}e^{-[t-(T/2)]/RC}, \quad T/2 \leq t \leq T. \quad (16.68)$$



**Figure 16.14** ▲ The effect of capacitor size on the steady-state response.

Equations 16.67 and 16.68 indicate that  $v_o(t)$  has half-wave symmetry and that therefore the average value of  $v_o$  is zero. This result agrees with the Fourier series solution for the steady-state response—namely, that because the excitation function has no zero frequency component, the response can have no such component. Equations 16.67 and 16.68 also show the effect of changing the size of the capacitor. If  $C$  is small, the exponential functions quickly vanish,  $v_o = V_m$  between 0 and  $T/2$ , and  $v_o = -V_m$  between  $T/2$  and  $T$ . In other words,  $v_o \rightarrow v_g$  as  $C \rightarrow 0$ . If  $C$  is large, the output waveform becomes triangular in shape, as Fig. 16.14 shows. Note that for large  $C$ , we may approximate the exponential terms  $e^{-t/RC}$  and  $e^{-[t-(T/2)]/RC}$  by the linear terms  $1 - (t/RC)$  and  $1 - \{[t - (T/2)]/RC\}$ , respectively. Equation 16.59 gives the Fourier series of this triangular waveform.

Figure 16.14 summarizes the results. The dashed line in Fig. 16.14 is the input voltage, the solid colored line depicts the output voltage when  $C$  is small, and the solid black line depicts the output voltage when  $C$  is large.

Finally, we verify that the steady-state response of Eqs. 16.67 and 16.68 is equivalent to the Fourier series solution in Eq. 16.58. To do so we simply derive the Fourier series representation of the periodic function described by Eqs. 16.67 and 16.68. We have already noted that the periodic voltage response has half-wave symmetry. Therefore the Fourier series contains only odd harmonics. For  $k$  odd,

$$\begin{aligned} a_k &= \frac{4}{T} \int_0^{T/2} \left( V_m - \frac{2V_m e^{-t/RC}}{1 + e^{-T/2RC}} \right) \cos k\omega_0 t \, dt \\ &= \frac{-8RCV_m}{T[1 + (k\omega_0 RC)^2]} \quad (k \text{ is odd}), \end{aligned} \quad (16.69)$$

$$\begin{aligned} b_k &= \frac{4}{T} \int_0^{T/2} \left( V_m - \frac{2V_m e^{-t/RC}}{1 + e^{-T/2RC}} \right) \sin k\omega_0 t \, dt \\ &= \frac{4V_m}{k\pi} - \frac{8k\omega_0 V_m R^2 C^2}{T[1 + (k\omega_0 RC)^2]} \quad (k \text{ is odd}). \end{aligned} \quad (16.70)$$

To show that the results obtained from Eqs. 16.69 and 16.70 are consistent with Eq. 16.58, we must prove that

$$\sqrt{a_k^2 + b_k^2} = \frac{4V_m}{k\pi} \frac{1}{\sqrt{1 + (k\omega_0 RC)^2}}, \quad (16.71)$$

and that

$$\frac{a_k}{b_k} = -k\omega_0 RC. \quad (16.72)$$

We leave you to verify Eqs. 16.69–16.72 in Problems 16.23 and 16.24. Equations 16.71 and 16.72 are used with Eqs. 16.38 and 16.39 to derive the Fourier series expression in Eq. 16.58; we leave the details to you in Problem 16.25.

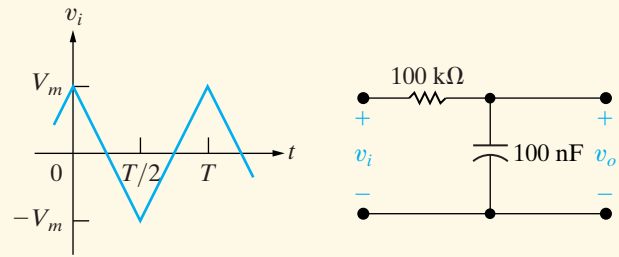
With this illustrative circuit, we showed how to use the Fourier series in conjunction with the principle of superposition to obtain the steady-state response to a periodic driving function. Again, the principal shortcoming of the Fourier series approach is the difficulty of ascertaining the waveform of the response. However, by thinking in terms of a circuit's frequency response, we can deduce a reasonable approximation of the steady-state response by using a finite number of appropriate terms in the Fourier series representation. (See Problems 16.28 and 16.30.)

## ASSESSMENT PROBLEMS

### Objective 2—Know how to analyze a circuit's response to a periodic waveform

**16.5** The periodic triangular-wave voltage seen on the left is applied to the circuit shown on the right. Derive the first three nonzero terms in the Fourier series that represents the steady-state voltage  $v_o$  if  $V_m = 281.25\pi^2$  mV and the period of the input voltage is  $200\pi$  ms.

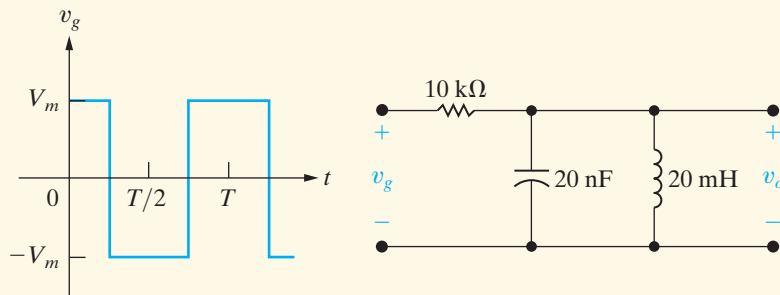
**Answer:**  $2238.83 \cos(10t - 5.71^\circ) + 239.46 \cos(30t - 16.70^\circ) + 80.50 \cos(50t - 26.57^\circ) + \dots$  mV



**16.6** The periodic square-wave shown on the left is applied to the circuit shown on the right.

- Derive the first four nonzero terms in the Fourier series that represents the steady-state voltage  $v_o$  if  $V_m = 210\pi$  V and the period of the input voltage is  $0.2\pi$  ms.
- Which harmonic dominates the output voltage? Explain why.

**Answer:** (a)  $17.5 \cos(10,000t + 88.81^\circ) + 26.14 \cos(30,000t - 95.36^\circ) + 168 \cos(50,000t) + 17.32 \cos(70,000t + 98.30^\circ) + \dots$  V;  
 (b) The fifth harmonic, at 10,000 rad/s, because the circuit is a bandpass filter with a center frequency of 50,000 rad/s and a quality factor of 10.



**NOTE:** Also try Chapter Problems 16.28 and 16.29.

## 16.6 Average-Power Calculations with Periodic Functions

If we have the Fourier series representation of the voltage and current at a pair of terminals in a linear lumped-parameter circuit, we can easily express the average power at the terminals as a function of the harmonic voltages and currents. Using the trigonometric form of the Fourier series

expressed in Eq. 16.38, we write the periodic voltage and current at the terminals of a network as

$$v = V_{\text{dc}} + \sum_{n=1}^{\infty} V_n \cos(n\omega_0 t - \theta_{vn}), \quad (16.73)$$

$$i = I_{\text{dc}} + \sum_{n=1}^{\infty} I_n \cos(n\omega_0 t - \theta_{in}). \quad (16.74)$$

The notation used in Eqs. 16.73 and 16.74 is defined as follows:

- $V_{\text{dc}}$  = the amplitude of the dc voltage component,
- $V_n$  = the amplitude of the  $n$ th-harmonic voltage,
- $\theta_{vn}$  = the phase angle of the  $n$ th-harmonic voltage,
- $I_{\text{dc}}$  = the amplitude of the dc current component,
- $I_n$  = the amplitude of the  $n$ th-harmonic current,
- $\theta_{in}$  = the phase angle of the  $n$ th-harmonic current.

We assume that the current reference is in the direction of the reference voltage drop across the terminals (using the passive sign convention), so that the instantaneous power at the terminals is  $vi$ . The average power is

$$P = \frac{1}{T} \int_{t_0}^{t_0+T} p \, dt = \frac{1}{T} \int_{t_0}^{t_0+T} vi \, dt. \quad (16.75)$$

To find the expression for the average power, we substitute Eqs. 16.73 and 16.74 into Eq. 16.75 and integrate. At first glance, this appears to be a formidable task, because the product  $vi$  requires multiplying two infinite series. However, the only terms to survive integration are the products of voltage and current at the same frequency. A review of Eqs. 16.8–16.10 should convince you of the validity of this observation. Therefore Eq. 16.75 reduces to

$$P = \frac{1}{T} V_{\text{dc}} I_{\text{dc}} t \Big|_{t_0}^{t_0+T} + \sum_{n=1}^{\infty} \frac{1}{T} \int_{t_0}^{t_0+T} V_n I_n \cos(n\omega_0 t - \theta_{vn}) \times \cos(n\omega_0 t - \theta_{in}) \, dt. \quad (16.76)$$

Now, using the trigonometric identity

$$\cos \alpha \cos \beta = \frac{1}{2} \cos(\alpha - \beta) + \frac{1}{2} \cos(\alpha + \beta),$$

we simplify Eq. 16.76 to

$$P = V_{\text{dc}} I_{\text{dc}} + \frac{1}{T} \sum_{n=1}^{\infty} \frac{V_n I_n}{2} \int_{t_0}^{t_0+T} [\cos(\theta_{vn} - \theta_{in}) + \cos(2n\omega_0 t - \theta_{vn} - \theta_{in})] \, dt. \quad (16.77)$$

The second term under the integral sign integrates to zero, so

$$P = V_{\text{dc}} I_{\text{dc}} + \sum_{n=1}^{\infty} \frac{V_n I_n}{2} \cos(\theta_{vn} - \theta_{in}). \quad (16.78)$$

Equation 16.78 is particularly important because it states that in the case of an interaction between a periodic voltage and the corresponding periodic current, the total average power is the sum of the average powers obtained from the interaction of currents and voltages of the same frequency. Currents and voltages of different frequencies do not interact to produce average

power. Therefore, in average-power calculations involving periodic functions, the total average power is the superposition of the average powers associated with each harmonic voltage and current. Example 16.4 illustrates the computation of average power involving a periodic voltage.

### Example 16.4 Calculating Average Power for a Circuit with a Periodic Voltage Source

Assume that the periodic square-wave voltage in Example 16.3 is applied across the terminals of a  $15\ \Omega$  resistor. The value of  $V_m$  is 60 V, and that of  $T$  is 5 ms.

- Write the first five nonzero terms of the Fourier series representation of  $v(t)$ . Use the trigonometric form given in Eq. 16.38.
- Calculate the average power associated with each term in (a).
- Calculate the total average power delivered to the  $15\ \Omega$  resistor.
- What percentage of the total power is delivered by the first five terms of the Fourier series?

#### Solution

- a) The dc component of  $v(t)$  is

$$a_v = \frac{(60)(T/4)}{T} = 15\ \text{V}.$$

From Example 16.3 we have

$$A_1 = \sqrt{2} 60/\pi = 27.01\ \text{V},$$

$$\theta_1 = 45^\circ,$$

$$A_2 = 60/\pi = 19.10\ \text{V},$$

$$\theta_2 = 90^\circ,$$

$$A_3 = 20\sqrt{2}/\pi = 9.00\ \text{V},$$

$$\theta_3 = 135^\circ,$$

$$A_4 = 0,$$

$$\theta_4 = 0^\circ,$$

$$A_5 = 5.40\ \text{V},$$

$$\theta_5 = 45^\circ,$$

$$\omega_0 = \frac{2\pi}{T} = \frac{2\pi(1000)}{5} = 400\pi\ \text{rad/s}.$$

Thus, using the first five nonzero terms of the Fourier series,

$$\begin{aligned} v(t) = & 15 + 27.01 \cos(400\pi t - 45^\circ) \\ & + 19.10 \cos(800\pi t - 90^\circ) \\ & + 9.00 \cos(1200\pi t - 135^\circ) \\ & + 5.40 \cos(2000\pi t - 45^\circ) + \cdots\ \text{V}. \end{aligned}$$

- b) The voltage is applied to the terminals of a resistor, so we can find the power associated with each term as follows:

$$P_{\text{dc}} = \frac{15^2}{15} = 15\ \text{W},$$

$$P_1 = \frac{1}{2} \frac{27.01^2}{15} = 24.32\ \text{W},$$

$$P_2 = \frac{1}{2} \frac{19.10^2}{15} = 12.16\ \text{W},$$

$$P_3 = \frac{1}{2} \frac{9^2}{15} = 2.70\ \text{W},$$

$$P_5 = \frac{1}{2} \frac{5.4^2}{15} = 0.97\ \text{W}.$$

- c) To obtain the total average power delivered to the  $15\ \Omega$  resistor, we first calculate the rms value of  $v(t)$ :

$$V_{\text{rms}} = \sqrt{\frac{(60)^2(T/4)}{T}} = \sqrt{900} = 30\ \text{V}.$$

The total average power delivered to the  $15\ \Omega$  resistor is

$$P_T = \frac{30^2}{15} = 60\ \text{W}.$$

- d) The total power delivered by the first five nonzero terms is

$$P = P_{\text{dc}} + P_1 + P_2 + P_3 + P_5 = 55.15\ \text{W}.$$

This is  $(55.15/60)(100)$ , or 91.92% of the total.

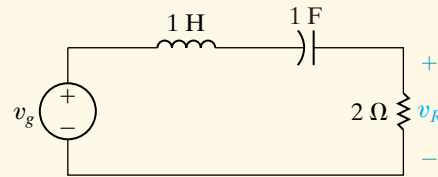
### ASSESSMENT PROBLEM

**Objective 3**—Be able to estimate the average power delivered to a resistor using a small number of Fourier coefficients

**16.7** The trapezoidal voltage function in Assessment Problem 16.3 is applied to the circuit shown. If  $12V_m = 296.09$  V and  $T = 2094.4$  ms, estimate the average power delivered to the  $2\ \Omega$  resistor.

**Answer:** 60.75 W.

*NOTE:* Also try Chapter Problems 16.34 and 16.35.



## 16.7 The rms Value of a Periodic Function

The rms value of a periodic function can be expressed in terms of the Fourier coefficients; by definition,

$$F_{\text{rms}} = \sqrt{\frac{1}{T} \int_{t_0}^{t_0+T} f(t)^2 dt}. \quad (16.79)$$

Representing  $f(t)$  by its Fourier series yields

$$F_{\text{rms}} = \sqrt{\frac{1}{T} \int_{t_0}^{t_0+T} \left[ a_v + \sum_{n=1}^{\infty} A_n \cos(n\omega_0 t - \theta_n) \right]^2 dt}. \quad (16.80)$$

The integral of the squared time function simplifies because the only terms to survive integration over a period are the product of the dc term and the harmonic products of the same frequency. All other products integrate to zero. Therefore Eq. 16.80 reduces to

$$\begin{aligned} F_{\text{rms}} &= \sqrt{\frac{1}{T} \left( a_v^2 T + \sum_{n=1}^{\infty} \frac{T}{2} A_n^2 \right)} \\ &= \sqrt{a_v^2 + \sum_{n=1}^{\infty} \frac{A_n^2}{2}} \\ &= \sqrt{a_v^2 + \sum_{n=1}^{\infty} \left( \frac{A_n}{\sqrt{2}} \right)^2}. \end{aligned} \quad (16.81)$$

Equation 16.81 states that the rms value of a periodic function is the square root of the sum obtained by adding the square of the rms value of each harmonic to the square of the dc value. For example, let's assume that a periodic voltage is represented by the finite series

$$\begin{aligned} v &= 10 + 30 \cos(\omega_0 t - \theta_1) + 20 \cos(2\omega_0 t - \theta_2) \\ &\quad + 5 \cos(3\omega_0 t - \theta_3) + 2 \cos(5\omega_0 t - \theta_5). \end{aligned}$$

The rms value of this voltage is

$$\begin{aligned} V &= \sqrt{10^2 + (30/\sqrt{2})^2 + (20/\sqrt{2})^2 + (5/\sqrt{2})^2 + (2/\sqrt{2})^2} \\ &= \sqrt{764.5} = 27.65 \text{ V}. \end{aligned}$$

Usually, infinitely many terms are required to represent a periodic function by a Fourier series, and therefore Eq. 16.81 yields an estimate of the true rms value. We illustrate this result in Example 16.5.

**Example 16.5** Estimating the rms Value of a Periodic Function

Use Eq. 16.81 to estimate the rms value of the voltage in Example 16.4.

Therefore,

**Solution**

From Example 16.4,

$$V_{\text{dc}} = 15 \text{ V},$$

$$V_1 = 27.01/\sqrt{2} \text{ V}, \text{ the rms value of the fundamental,}$$

$$V_2 = 19.10/\sqrt{2} \text{ V}, \text{ the rms value of the second harmonic,}$$

$$V_3 = 9.00/\sqrt{2} \text{ V}, \text{ the rms value of the third harmonic,}$$

$$V_5 = 5.40/\sqrt{2} \text{ V}, \text{ the rms value of the fifth harmonic.}$$

$$\begin{aligned} V_{\text{rms}} &= \sqrt{15^2 + \left(\frac{27.01}{\sqrt{2}}\right)^2 + \left(\frac{19.10}{\sqrt{2}}\right)^2 + \left(\frac{9.00}{\sqrt{2}}\right)^2 + \left(\frac{5.40}{\sqrt{2}}\right)^2} \\ &= 28.76 \text{ V.} \end{aligned}$$

From Example 16.4, the true rms value is 30 V. We approach this value by including more and more harmonics in Eq. 16.81. For example, if we include the harmonics through  $k = 9$ , the equation yields a value of 29.32 V.

*NOTE:* Assess your understanding of this material by trying Chapter Problems 16.37 and 16.39.

## 16.8 The Exponential Form of the Fourier Series

The exponential form of the Fourier series is of interest because it allows us to express the series concisely. The exponential form of the series is

$$f(t) = \sum_{n=-\infty}^{\infty} C_n e^{jn\omega_0 t}, \quad (16.82)$$

where

$$C_n = \frac{1}{T} \int_{t_0}^{t_0+T} f(t) e^{-jn\omega_0 t} dt. \quad (16.83)$$

To derive Eqs. 16.82 and 16.83, we return to Eq. 16.2 and replace the cosine and sine functions with their exponential equivalents:

$$\cos n\omega_0 t = \frac{e^{jn\omega_0 t} + e^{-jn\omega_0 t}}{2}, \quad (16.84)$$

$$\sin n\omega_0 t = \frac{e^{jn\omega_0 t} - e^{-jn\omega_0 t}}{2j}. \quad (16.85)$$

Substituting Eqs. 16.84 and 16.85 into Eq. 16.2 gives

$$\begin{aligned} f(t) &= a_v + \sum_{n=1}^{\infty} \frac{a_n}{2} (e^{jn\omega_0 t} + e^{-jn\omega_0 t}) + \frac{b_n}{2j} (e^{jn\omega_0 t} - e^{-jn\omega_0 t}) \\ &= a_v + \sum_{n=1}^{\infty} \left( \frac{a_n - jb_n}{2} \right) e^{jn\omega_0 t} + \left( \frac{a_n + jb_n}{2} \right) e^{-jn\omega_0 t}. \end{aligned} \quad (16.86)$$

Now we define  $C_n$  as

$$C_n = \frac{1}{2} (a_n - jb_n) = \frac{A_n}{2} \angle -\theta_n, \quad n = 1, 2, 3, \dots \quad (16.87)$$

From the definition of  $C_n$ ,

$$\begin{aligned} C_n &= \frac{1}{2} \left[ \frac{2}{T} \int_{t_0}^{t_0+T} f(t) \cos n\omega_0 t \, dt - j \frac{2}{T} \int_{t_0}^{t_0+T} f(t) \sin n\omega_0 t \, dt \right] \\ &= \frac{1}{T} \int_{t_0}^{t_0+T} f(t) (\cos n\omega_0 t - j \sin n\omega_0 t) \, dt \\ &= \frac{1}{T} \int_{t_0}^{t_0+T} f(t) e^{-jn\omega_0 t} \, dt, \end{aligned} \quad (16.88)$$

which completes the derivation of Eq. 16.83. To complete the derivation of Eq. 16.82, we first observe from Eq. 16.88 that

$$C_0 = \frac{1}{T} \int_{t_0}^{t_0+T} f(t) \, dt = a_v. \quad (16.89)$$

Next we note that

$$C_{-n} = \frac{1}{T} \int_{t_0}^{t_0+T} f(t) e^{jn\omega_0 t} \, dt = C_n^* = \frac{1}{2}(a_n + jb_n). \quad (16.90)$$

Substituting Eqs. 16.87, 16.89, and 16.90 into Eq. 16.86 yields

$$\begin{aligned} f(t) &= C_0 + \sum_{n=1}^{\infty} (C_n e^{jn\omega_0 t} + C_n^* e^{-jn\omega_0 t}) \\ &= \sum_{n=0}^{\infty} C_n e^{jn\omega_0 t} + \sum_{n=1}^{\infty} C_n^* e^{-jn\omega_0 t}. \end{aligned} \quad (16.91)$$

Note that the second summation on the right-hand side of Eq. 16.91 is equivalent to summing  $C_n e^{jn\omega_0 t}$  from  $-1$  to  $-\infty$ ; that is,

$$\sum_{n=1}^{\infty} C_n^* e^{-jn\omega_0 t} = \sum_{n=-1}^{-\infty} C_n e^{jn\omega_0 t}. \quad (16.92)$$

Because the summation from  $-1$  to  $-\infty$  is the same as the summation from  $-\infty$  to  $-1$ , we use Eq. 16.92 to rewrite Eq. 16.91:

$$\begin{aligned} f(t) &= \sum_{n=0}^{\infty} C_n e^{jn\omega_0 t} + \sum_{n=-\infty}^{-1} C_n e^{jn\omega_0 t} \\ &= \sum_{n=-\infty}^{\infty} C_n e^{jn\omega_0 t}, \end{aligned} \quad (16.93)$$

which completes the derivation of Eq. 16.82.

We may also express the rms value of a periodic function in terms of the complex Fourier coefficients. From Eqs. 16.81, 16.87, and 16.89,

$$F_{\text{rms}} = \sqrt{a_v^2 + \sum_{n=1}^{\infty} \frac{a_n^2 + b_n^2}{2}}, \quad (16.94)$$

$$|C_n| = \frac{\sqrt{a_n^2 + b_n^2}}{2}, \quad (16.95)$$

$$C_0^2 = a_v^2. \quad (16.96)$$

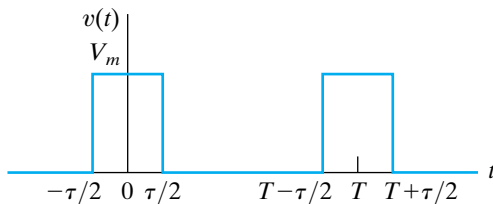
Substituting Eqs. 16.95 and 16.96 into Eq. 16.94 yields the desired expression:

$$F_{\text{rms}} = \sqrt{C_0^2 + 2 \sum_{n=1}^{\infty} |C_n|^2}. \quad (16.97)$$

Example 16.6 illustrates the process of finding the exponential Fourier series representation of a periodic function.

**Example 16.6** Finding the Exponential Form of the Fourier Series

Find the exponential Fourier series for the periodic voltage shown in Fig. 16.15.



**Figure 16.15** ▲ The periodic voltage for Example 16.6.

**Solution**

Using  $-\tau/2$  as the starting point for the integration, we have, from Eq. 16.83,

$$\begin{aligned} C_n &= \frac{1}{T} \int_{-\tau/2}^{\tau/2} V_m e^{-jn\omega_0 t} dt \\ &= \frac{V_m}{T} \left( \frac{e^{-jn\omega_0 t}}{-jn\omega_0} \right) \Big|_{-\tau/2}^{\tau/2} \end{aligned}$$

$$\begin{aligned} &= \frac{jV_m}{n\omega_0 T} (e^{-jn\omega_0 \tau/2} - e^{jn\omega_0 \tau/2}) \\ &= \frac{2V_m}{n\omega_0 T} \sin n\omega_0 \tau/2. \end{aligned}$$

Here, because  $v(t)$  has even symmetry,  $b_n = 0$  for all  $n$ , and hence we expect  $C_n$  to be real. Moreover, the amplitude of  $C_n$  follows a  $(\sin x)/x$  distribution, as indicated when we rewrite

$$C_n = \frac{V_m \tau}{T} \frac{\sin(n\omega_0 \tau/2)}{n\omega_0 \tau/2}.$$

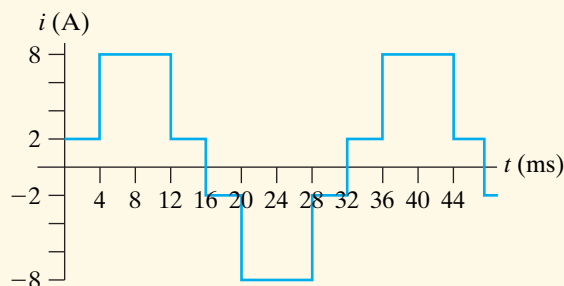
We say more about this subject in Section 16.9. The exponential series representation of  $v(t)$  is

$$\begin{aligned} v(t) &= \sum_{n=-\infty}^{\infty} \left( \frac{V_m \tau}{T} \right) \frac{\sin(n\omega_0 \tau/2)}{n\omega_0 \tau/2} e^{jn\omega_0 t} \\ &= \left( \frac{V_m \tau}{T} \right) \sum_{n=-\infty}^{\infty} \frac{\sin(n\omega_0 \tau/2)}{n\omega_0 \tau/2} e^{jn\omega_0 t}. \end{aligned}$$

**ASSESSMENT PROBLEMS**

**Objective 4**—Be able to calculate the exponential form of the Fourier coefficients for a periodic waveform

- 16.8** Derive the expression for the Fourier coefficients  $C_n$  for the periodic function shown. *Hint:* Take advantage of symmetry by using the fact that  $C_n = (a_n - jb_n)/2$ .



**Answer:**  $C_n = -j \frac{4}{\pi n} (1 + 3 \cos \frac{n\pi}{4})$ ,  $n$  odd

**NOTE:** Also try Chapter Problems 16.44 and 16.45.

- 16.9** a) Calculate the rms value of the periodic current in Assessment Problem 16.8.  
 b) Using  $C_1$ – $C_{11}$ , estimate the rms value.  
 c) What is the percentage of error in the value obtained in (b), based on the true value found in (a)?  
 d) For this periodic function, could fewer terms be used to estimate the rms value and still insure the error is less than 1%?

**Answer:** (a)  $\sqrt{34}$  A;  
 (b) 5.777 A;  
 (c)  $-0.93$  %;  
 (d) yes; if  $C_1$ – $C_9$  are used, the error is  $-0.98$  %.



## 16.9 Amplitude and Phase Spectra

A periodic time function is defined by its Fourier coefficients and its period. In other words, when we know  $a_0$ ,  $a_n$ ,  $b_n$ , and  $T$ , we can construct  $f(t)$ , at least theoretically. When we know  $a_n$  and  $b_n$ , we also know the amplitude ( $A_n$ ) and phase angle ( $-\theta_n$ ) of each harmonic. Again, we cannot, in general, visualize what the periodic function looks like in the time domain from a description of the coefficients and phase angles; nevertheless, we recognize that these quantities characterize the periodic function completely. Thus, with sufficient computing time, we can synthesize the time-domain waveform from the amplitude and phase angle data. Also, when a periodic driving function is exciting a circuit that is highly frequency selective, the Fourier series of the steady-state response is dominated by just a few terms. Thus the description of the response in terms of amplitude and phase may provide an understanding of the output waveform.

We can present graphically the description of a periodic function in terms of the amplitude and phase angle of each term in the Fourier series of  $f(t)$ . The plot of the amplitude of each term versus the frequency is called the **amplitude spectrum** of  $f(t)$ , and the plot of the phase angle versus the frequency is called the **phase spectrum** of  $f(t)$ . Because the amplitude and phase angle data occur at discrete values of the frequency (that is, at  $\omega_0, 2\omega_0, 3\omega_0, \dots$ ), these plots also are referred to as **line spectra**.

### An Illustration of Amplitude and Phase Spectra

Amplitude and phase spectra plots are based on either Eq. 16.38 ( $A_n$  and  $-\theta_n$ ) or Eq. 16.82 ( $C_n$ ). We focus on Eq. 16.82 and leave the plots based on Eq. 16.38 to Problem 16.49. To illustrate the amplitude and phase spectra, which are based on the exponential form of the Fourier series, we use the periodic voltage of Example 16.6. To aid the discussion, we assume that  $V_m = 5$  V and  $\tau = T/5$ . From Example 16.6,

$$C_n = \frac{V_m \tau}{T} \frac{\sin(n\omega_0 \tau / 2)}{n\omega_0 \tau / 2}, \quad (16.98)$$

which for the assumed values of  $V_m$  and  $\tau$  reduces to

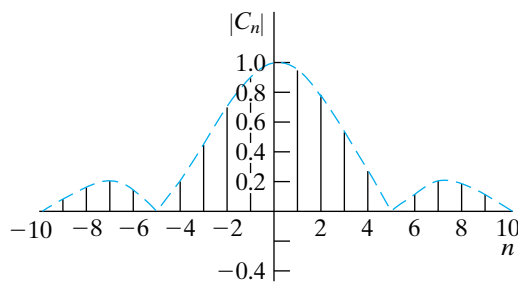
$$C_n = 1 \frac{\sin(n\pi/5)}{n\pi/5}. \quad (16.99)$$

Figure 16.16 illustrates the plot of the magnitude of  $C_n$  from Eq. 16.99 for values of  $n$  ranging from  $-10$  to  $+10$ . The figure clearly shows that the amplitude spectrum is bounded by the envelope of the  $|(\sin x)/x|$  function. We used the order of the harmonic as the frequency scale because the numerical value of  $T$  is not specified. When we know  $T$ , we also know  $\omega_0$  and the frequency corresponding to each harmonic.

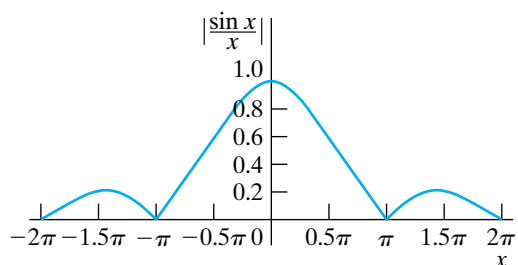
Figure 16.17 provides the plot of  $|(\sin x)/x|$  versus  $x$ , where  $x$  is in radians. It shows that the function goes through zero whenever  $x$  is an integral multiple of  $\pi$ . From Eq. 16.98,

$$n\omega_0 \left( \frac{\tau}{2} \right) = \frac{n\pi \tau}{T} = \frac{n\pi}{T/\tau}. \quad (16.100)$$

From Eq. 16.100, we deduce that the amplitude spectrum goes through zero whenever  $n\tau/T$  is an integer. For example, in the plot,  $\tau/T$  is  $1/5$ , and therefore the envelope goes through zero at  $n = 5, 10, 15, 10, 5$ , and so



**Figure 16.16** ▲ The plot of  $C_n$  versus  $n$  when  $\tau = T/5$ , for the periodic voltage for Example 16.6.



**Figure 16.17** ▲ The plot of  $(\sin x)/x$  versus  $x$ .

on. In other words, the fifth, tenth, fifteenth, . . . harmonics are all zero. As the reciprocal of  $\tau/T$  becomes an increasingly larger integer, the number of harmonics between every  $\pi$  radians increases. If  $n\pi/T$  is not an integer, the amplitude spectrum still follows the  $|(\sin x)/x|$  envelope. However, the envelope is not zero at an integral multiple of  $\omega_0$ .

Because  $C_n$  is real for all  $n$ , the phase angle associated with  $C_n$  is either zero or  $180^\circ$ , depending on the algebraic sign of  $(\sin n\pi/5)/(n\pi/5)$ . For example, the phase angle is zero for  $n = 0, \pm 1, \pm 2, \pm 3$ , and  $\pm 4$ . It is not defined at  $n = \pm 5$ , because  $C_{\pm 5}$  is zero. The phase angle is  $180^\circ$  at  $n = \pm 6, \pm 7, \pm 8$ , and  $\pm 9$ , and it is not defined at  $\pm 10$ . This pattern repeats itself as  $n$  takes on larger integer values. Figure 16.18 shows the phase angle of  $C_n$  given by Eq. 16.98.

Now, what happens to the amplitude and phase spectra if  $f(t)$  is shifted along the time axis? To find out, we shift the periodic voltage in Example 16.6  $t_0$  units to the right. By hypothesis,

$$v(t) = \sum_{n=-\infty}^{\infty} C_n e^{jn\omega_0 t}. \quad (16.101)$$

Therefore

$$v(t - t_0) = \sum_{n=-\infty}^{\infty} C_n e^{jn\omega_0(t-t_0)} = \sum_{n=-\infty}^{\infty} C_n e^{-jn\omega_0 t_0} e^{jn\omega_0 t}, \quad (16.102)$$

which indicates that shifting the origin has no effect on the amplitude spectrum, because

$$|C_n| = |C_n e^{-jn\omega_0 t_0}|. \quad (16.103)$$

However, reference to Eq. 16.87 reveals that the phase spectrum has changed to  $-(\theta_n + n\omega_0 t_0)$  rads. For example, let's shift the periodic voltage in Example 16.1  $\tau/2$  units to the right. As before, we assume that  $\tau = T/5$ ; then the new phase angle  $\theta'_n$  is

$$\theta'_n = -(\theta_n + n\pi/5). \quad (16.104)$$

We have plotted Eq. 16.104 in Fig. 16.19 for  $n$  ranging from  $-8$  to  $+8$ . Note that no phase angle is associated with a zero amplitude coefficient.

You may wonder why we have devoted so much attention to the amplitude spectrum of the periodic pulse in Example 16.6. The reason is that this particular periodic waveform provides an excellent way to illustrate the transition from the Fourier series representation of a periodic function to the Fourier transform representation of a nonperiodic function. We discuss the Fourier transform in Chapter 17.

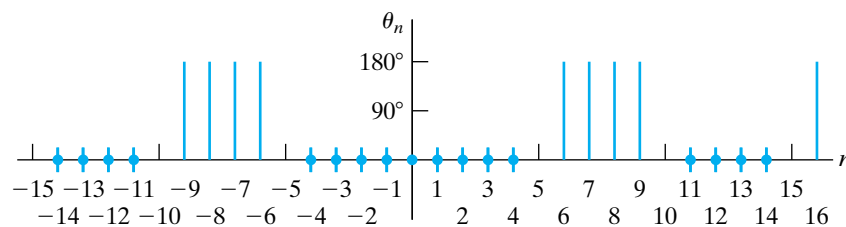


Figure 16.18 ▲ The phase angle of  $C_n$ .

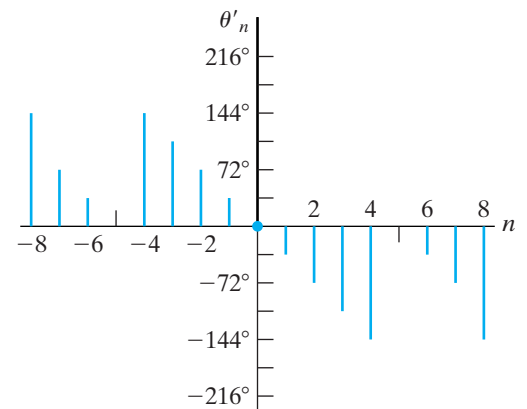


Figure 16.19 ▲ The plot of  $\theta'_n$  versus  $n$  for Eq. 16.104.

## ASSESSMENT PROBLEM

**Objective 4**—Be able to calculate the exponential form of the Fourier coefficients for a periodic waveform

**16.10** The function in Assessment Problem 16.8 is shifted along the time axis 8 ms to the right. Write the exponential Fourier series for the periodic current.

**Answer:**

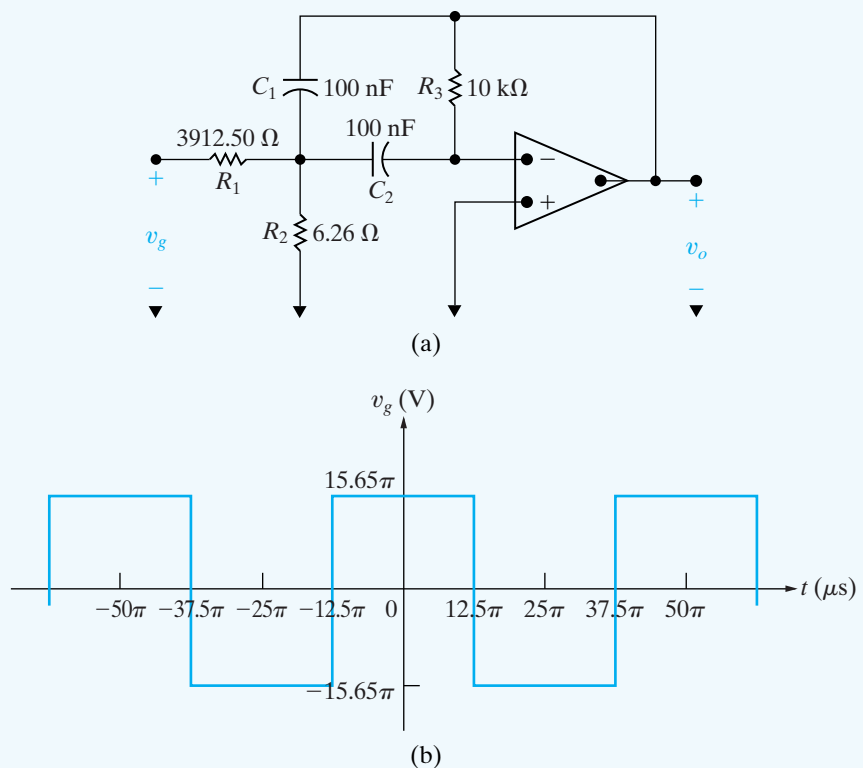
$$i(t) = \frac{4}{\pi} \sum_{n=-\infty(\text{odd})}^{\infty} \frac{1}{n} \left(1 + 3 \cos \frac{n\pi}{4}\right) e^{-j\pi/2(n+1)} e^{jn\omega_0 t} \text{ A.}$$

*NOTE: Also try Chapter Problems 16.49 and 16.50.*

## Practical Perspective

### Active High-Q Filters

Consider the narrowband op amp bandpass filter shown in Fig. 16.20(a). The square wave voltage shown in Fig. 16.20(b) is the input to the filter. We know that the square wave is comprised of an infinite sum of sinusoids, one sinusoid at the same frequency as the square wave and all of the remaining sinusoids at integer multiples of that frequency. What effect will the filter have on this input sum of sinusoids?



**Figure 16.20** ▲ (a) narrowband bandpass filter; (b) square wave input.

The Fourier series representation of the square wave in Fig. 16.20(b) is given by

$$v_g(t) = \frac{4A}{\pi} \sum_{n=1,3,5,\dots}^{\infty} \frac{1}{n} \sin \frac{n\pi}{2} \cos n\omega_0 t$$

where  $A = 15.65\pi\text{V}$ . The first three terms of this Fourier series are given by

$$v_g(t) = 62.6 \cos \omega_0 t - 20.87 \cos 3\omega_0 t + 12.52 \cos 5\omega_0 t - \dots$$

The period of the square wave is  $50\pi \mu\text{s}$  so the frequency of the square wave is  $40,000 \text{ rad/s}$ .

The transfer function for the bandpass filter in Fig. 16.20(a) is

$$H(s) = \frac{K\beta s}{s^2 + \beta s + \omega_0^2}$$

where  $K = 400/313$ ,  $\beta = 2000 \text{ rad/s}$ ,  $\omega_0 = 40,000 \text{ rad/s}$ . This filter has a quality factor of  $40,000/2000 = 20$ . Note that the center frequency of the bandpass filter equals the frequency of the input square wave.

Multiply each term of the Fourier series representation of the square wave, represented as a phasor, by the transfer function  $H(s)$  evaluated at the frequency of the term in the Fourier series to get the representation of the output voltage of the filter as a Fourier series:

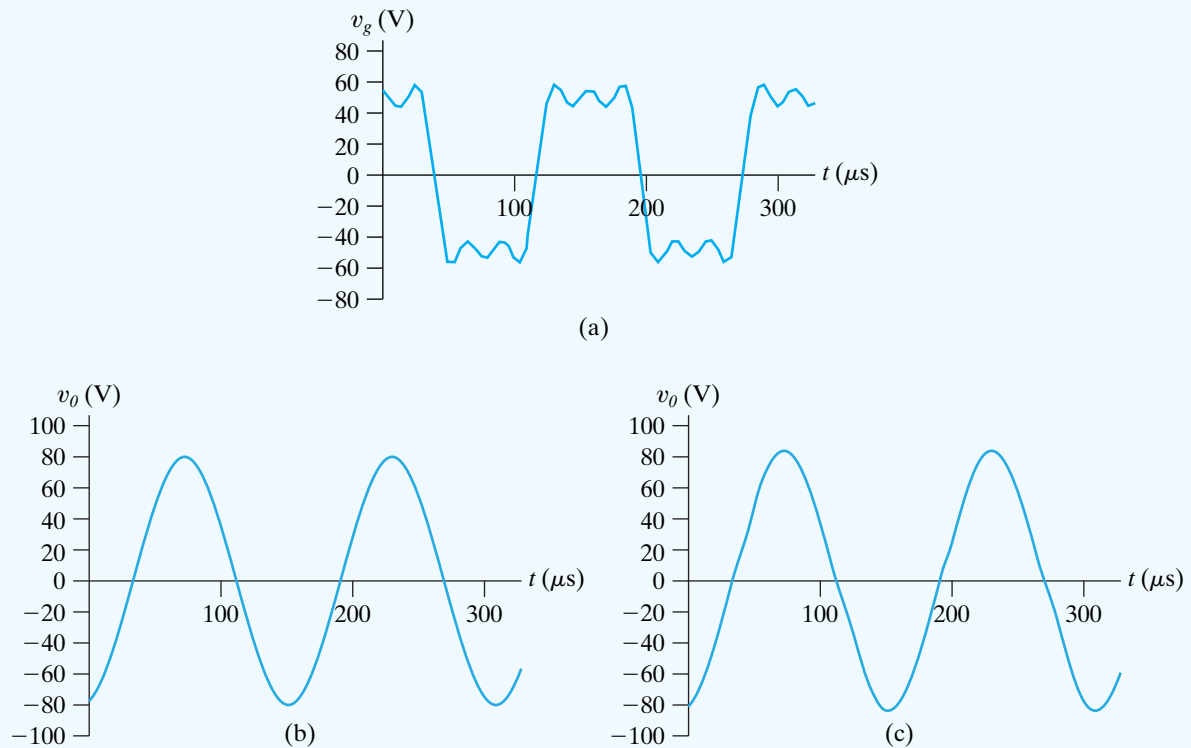
$$v_g(t) = -80 \cos \omega_0 t - 0.5 \cos 3\omega_0 t + 0.17 \cos 5\omega_0 t - \dots$$

Notice the selective nature of the bandpass filter, which effectively amplifies the fundamental frequency component of the input square wave and attenuates all of the harmonic components.

Now make the following changes to the bandpass filter of Fig. 16.20(a) — let  $R_1 = 391.25 \Omega$ ,  $R_2 = 74.4 \Omega$ ,  $R_3 = 1 \text{ k}\Omega$ , and  $C_1 = C_2 = 0.1 \mu\text{F}$ . The transfer function for the filter,  $H(s)$ , has the same form given above, but now  $K = 400/313$ ,  $\beta = 20,000 \text{ rad/s}$ ,  $\omega_0 = 40,000 \text{ rad/s}$ . The pass-band gain and center frequency are unchanged, but the bandwidth has increased by a factor of 10. This makes the quality factor 2, and the resulting bandpass filter is less selective than the original filter. We can see this by looking at the output voltage of the filter as a Fourier series:

$$v_0(t) = -80 \cos \omega_0 t - 5 \cos 3\omega_0 t + 1.63 \cos 5\omega_0 t - \dots$$

The fundamental frequency of the input has the same amplification factor, but the higher harmonic components have not been attenuated as significantly as they were when the filter with  $Q = 20$  was used. Figure 16.21 plots the first three terms of the Fourier series representations of the input square wave and the resulting output waveforms for the two bandpass filters. Note the nearly perfect replication of a sinusoid in Fig. 16.21(b) and the distortion that results from the use of a less-selective filter in Fig. 16.21(c).



**Figure 16.21** ▲ (a) The first three terms of the Fourier series of the square wave in Fig. 16.20(b); (b) the first three terms of the Fourier series of the output from the bandpass filter in Fig. 16.20(a), where  $Q = 20$ ; (c) the first three terms of the Fourier series of the output from the bandpass filter in Fig. 16.20(a) with component values changed to give  $Q = 2$ .

*NOTE:* Assess your understanding of the Practical Perspective by solving Chapter Problems 16.56–16.57.

## Summary

- A **periodic function** is a function that repeats itself every  $T$  seconds.
  - A period is the smallest time interval ( $T$ ) that a periodic function can be shifted to produce a function identical to itself. (See page 602.)
  - The Fourier series is an infinite series used to represent a periodic function. The series consists of a constant term and infinitely many harmonically related cosine and sine terms. (See page 605.)
  - The **fundamental frequency** is the frequency determined by the fundamental period ( $f_0 = 1/T$  or  $\omega_0 = 2\pi f_0$ ). (See page 605.)
  - The **harmonic frequency** is an integer multiple of the fundamental frequency. (See page 605.)
  - The **Fourier coefficients** are the constant term and the coefficient of each cosine and sine term in the series. (See Eqs. 16.3–16.5.) (See page 606.)
  - Five types of symmetry are used to simplify the computation of the Fourier coefficients:
    - *even*, in which all sine terms in the series are zero
    - *odd*, in which all cosine terms and the constant term are zero
    - *half-wave*, in which all even harmonics are zero
    - *quarter-wave, half-wave, even*, in which the series contains only odd harmonic cosine terms
    - *quarter-wave, half-wave, odd*, in which the series contains only odd harmonic sine terms
- (See page 609.)
- In the alternative form of the Fourier series, each harmonic represented by the sum of a cosine and sine term is combined into a single term of the form  $A_n \cos(n\omega_0 t - \theta_n)$ . (See page 615.)

- For steady-state response, the Fourier series of the response signal is determined by first finding the response to each component of the input signal. The individual responses are added (super-imposed) to form the Fourier series of the response signal. The response to the individual terms in the input series is found by either frequency domain or  $s$ -domain analysis. (See page 617.)
- The waveform of the response signal is difficult to obtain without the aid of a computer. Sometimes the frequency response (or filtering) characteristics of the circuit can be used to ascertain how closely the output waveform matches the input waveform. (See page 618.)
- Only harmonics of the same frequency interact to produce average power. The total average power is the sum of the average powers associated with each frequency. (See page 621.)
- The rms value of a periodic function can be estimated from the Fourier coefficients. (See Eqs. 16.81, 16.94, and 16.97.) (See page 624.)
- The Fourier series may also be written in exponential form by using Euler's identity to replace the cosine and sine terms with their exponential equivalents. (See page 625.)
- The Fourier series is used to predict the steady-state response of a system when the system is excited by a periodic signal. The series assists in finding the steady-state response by transferring the analysis from the time domain to the frequency domain.

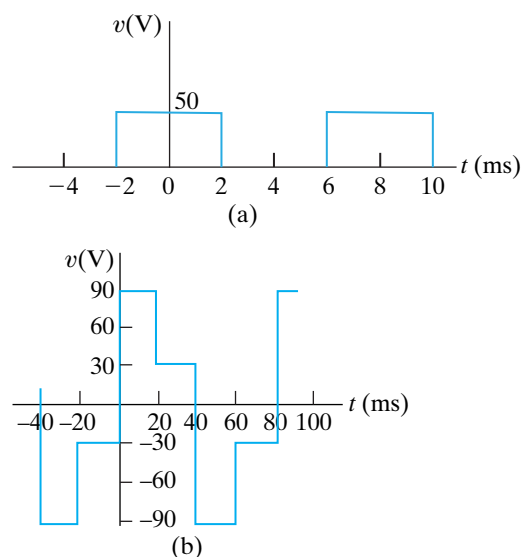
## Problems

### Sections 16.1–16.2

**16.1** For each of the periodic functions in Fig. P16.1, specify

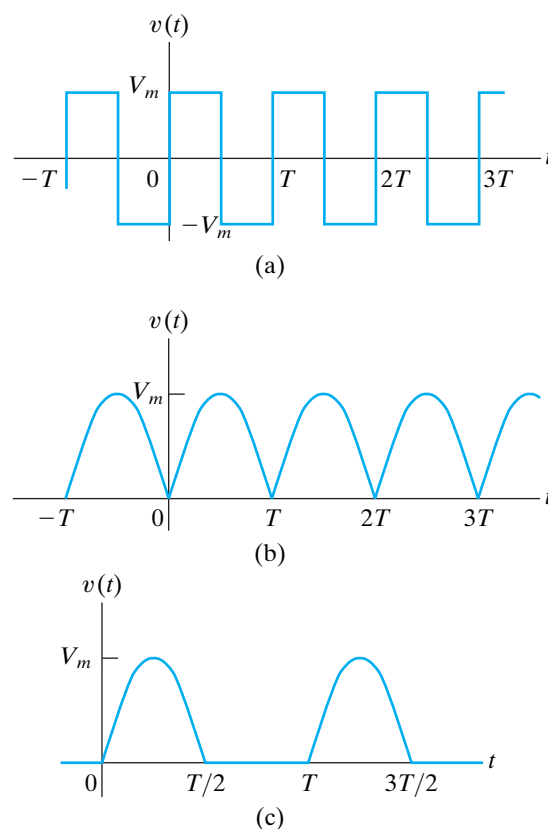
- $\omega_o$  in radians per second
- $f_o$  in hertz
- the value of  $a_v$
- the equations for  $a_k$  and  $b_k$
- $v(t)$  as a Fourier series

**Figure P16.1**



**16.2** Find the Fourier series expressions for the periodic voltage functions shown in Fig. P16.2. Note that Fig. P16.1(a) illustrates the square wave; Fig. P16.2 (b) illustrates the full-wave rectified sine wave, where  $v(t) = V_m \sin(\pi/T)t$ ,  $0 \leq t \leq T$ ; and Fig. P16.2 (c) illustrates the half-wave rectified sine wave, where  $v(t) = V_m \sin(2\pi/T)t$ ,  $0 \leq t \leq T/2$ .

**Figure P16.2**

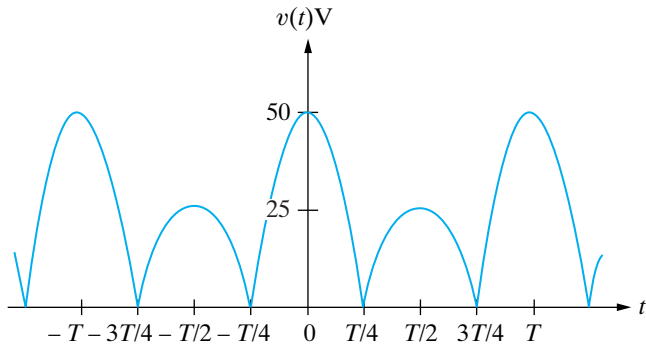


**16.3** Derive the Fourier series for the periodic voltage shown in Fig. P16.3, given that

$$v(t) = 50 \cos \frac{2\pi}{T} t \text{ V}, \quad -\frac{T}{4} \leq t \leq \frac{T}{4};$$

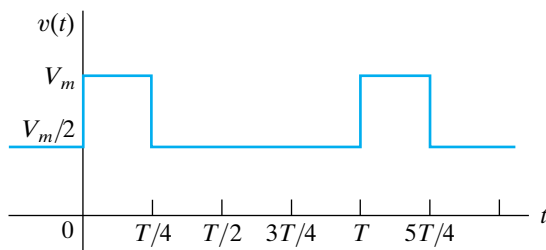
$$v(t) = -25 \cos \frac{2\pi}{T} t \text{ V}, \quad \frac{T}{4} \leq t \leq \frac{3T}{4}.$$

Figure P16.3



- 16.4** Derive the expressions for  $a_n$ ,  $a_k$ , and  $b_k$  for the periodic voltage shown in Fig. P16.4 if  $V_m = 100\pi$  V.

Figure P16.4



- 16.5** a) Verify Eqs. 16.6 and 16.7.  
 b) Verify Eq. 16.8. *Hint:* Use the trigonometric identity  $\cos \alpha \sin \beta = \frac{1}{2} \sin(\alpha + \beta) - \frac{1}{2} \sin(\alpha - \beta)$ .  
 c) Verify Eq. 16.9. *Hint:* Use the trigonometric identity  $\sin \alpha \sin \beta = \frac{1}{2} \cos(\alpha - \beta) - \frac{1}{2} \cos(\alpha + \beta)$ .  
 d) Verify Eq. 16.10. *Hint:* Use the trigonometric identity  $\cos \alpha \cos \beta = \frac{1}{2} \cos(\alpha - \beta) + \frac{1}{2} \cos(\alpha + \beta)$ .

- 16.6** Derive Eq. 16.5.

### Section 16.3

- 16.7** Derive the expressions for the Fourier coefficients of an odd periodic function. *Hint:* Use the same technique as used in the text in deriving Eqs. 16.14–16.16.

- 16.8** Show that if  $f(t) = -f(t - T/2)$ , the Fourier coefficients  $b_k$  are given by the expressions

$$b_k = 0 \quad \text{for } k \text{ even;}$$

$$b_k = \frac{4}{T} \int_0^{T/2} f(t) \sin k\omega_0 t \, dt, \quad \text{for } k \text{ odd.}$$

*Hint:* Use the same technique as used in the text to derive Eqs. 16.28 and 16.29.

- 16.9** Derive Eqs. 16.36. *Hint:* Start with Eq. 16.29 and divide the interval of integration into 0 to  $T/4$  and  $T/4$  to  $T/2$ . Note that because of evenness and quarter-wave symmetry,  $f(t) = -f(T/2 - t)$  in the

interval  $T/4 \leq t \leq T/2$ . Let  $x = T/2 - t$  in the second interval and combine the resulting integral with the integration between 0 and  $T/4$ .

- 16.10** Derive Eqs. 16.37. Follow the hint given in Problem 16.9 except that because of oddness and quarter-wave symmetry,  $f(t) = f(T/2 - t)$  in the interval  $T/4 \leq t \leq T/2$ .

- 16.11** It is given that  $v(t) = 50 \cos \pi|t|$  V over the interval  $-1 \leq t \leq 1$  s. The function then repeats itself.

- a) What is the fundamental frequency in radians per second?  
 b) Is the function even?  
 c) Is the function odd?  
 d) Does the function have half-wave symmetry?

- 16.12** One period of a periodic function is described by the following equations:

$$i(t) = -8t \text{ A}, \quad -5 \text{ ms} \leq t \leq 5 \text{ ms};$$

$$i(t) = -40 \text{ mA}, \quad 5 \text{ ms} \leq t \leq 15 \text{ ms};$$

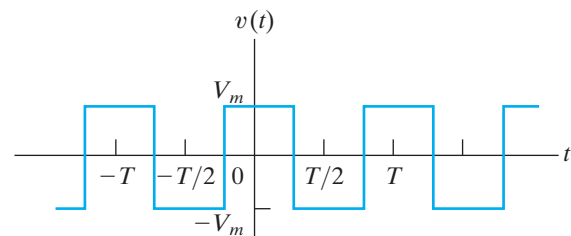
$$i(t) = 8t - 0.16 \text{ A}, \quad 15 \text{ ms} \leq t \leq 25 \text{ ms};$$

$$i(t) = 40 \text{ mA}, \quad 25 \text{ ms} \leq t \leq 35 \text{ ms}.$$

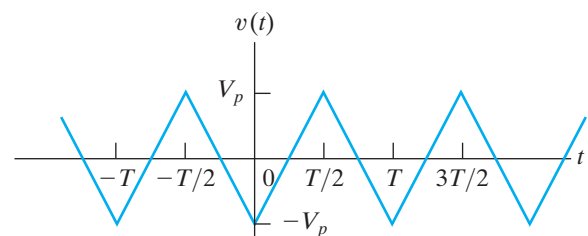
- a) What is the fundamental frequency in hertz?  
 b) Is the function even?  
 c) Is the function odd?  
 d) Does the function have half-wave symmetry?  
 e) Does the function have quarter-wave symmetry?  
 f) Give the numerical expressions for  $a_n$ ,  $a_k$ , and  $b_k$ .

- 16.13** Find the Fourier series of each periodic function shown in Fig. P16.13.

Figure P16.13



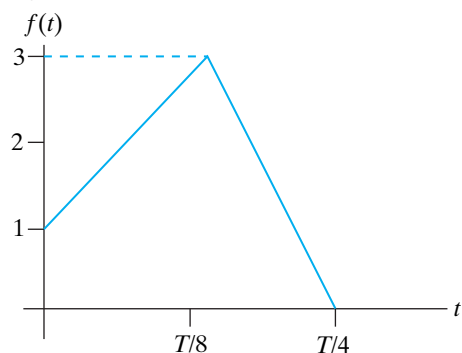
(a)



(b)

- 16.14** The periodic function shown in Fig. P16.14 is even and has both half-wave and quarter-wave symmetry.
- Sketch one full cycle of the function over the interval  $-T/4 \leq t \leq 3T/4$ .
  - Derive the expression for the Fourier coefficients  $a_v$ ,  $a_k$ , and  $b_k$ .
  - Write the first three nonzero terms in the Fourier expansion of  $f(t)$ .
  - Use the first three nonzero terms to estimate  $f(T/8)$ .

Figure P16.14

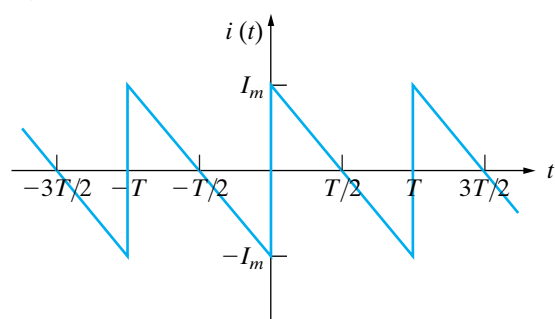


- 16.15** It is given that  $f(t) = 10t^2$  over the interval  $-5 < t < 5$  s.
- Construct a periodic function that satisfies this  $f(t)$  between  $-5$  and  $+5$  s, has a period of 20 s, and has half-wave symmetry.
  - Is the function even or odd?
  - Does the function have quarter-wave symmetry?
  - Derive the Fourier series for  $f(t)$ .
  - Write the Fourier series for  $f(t)$  if  $f(t)$  is shifted 5 s to the right.

- 16.16** Repeat Problem 16.15 given that  $f(t) = 2t^3$  over the interval  $-5 < t < 5$  s.

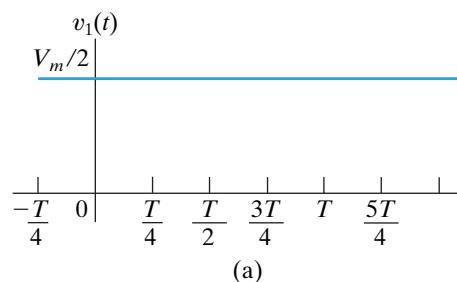
- 16.17**
- Derive the Fourier series for the periodic current shown in Fig. P16.17.
  - Repeat (a) if the vertical reference axis is shifted  $T/2$  units to the right.

Figure P16.17

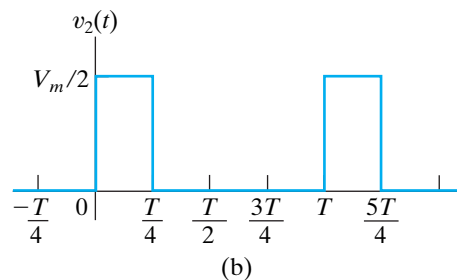


- 16.18** It is sometimes possible to use symmetry to find the Fourier coefficients, even though the original function is not symmetrical! With this thought in mind, consider the function in Fig. P16.4. Observe that  $v(t)$  can be divided into the two functions illustrated in Fig. P16.18(a) and (b). Furthermore, we can make  $v_2(t)$  an even function by shifting it  $T/8$  units to the left. This is illustrated in Fig. P16.18(c). At this point we note that  $v(t) = v_1(t) + v_2(t)$  and that the Fourier series of  $v_1(t)$  is a single-term series consisting of  $V_m/2$ . To find the Fourier series of  $v_2(t)$ , we first find the Fourier series of  $v_2(t + T/8)$  and then shift this series  $T/8$  units to the right. Use the technique just outlined to verify the Fourier coefficients found in Problem 16.4.

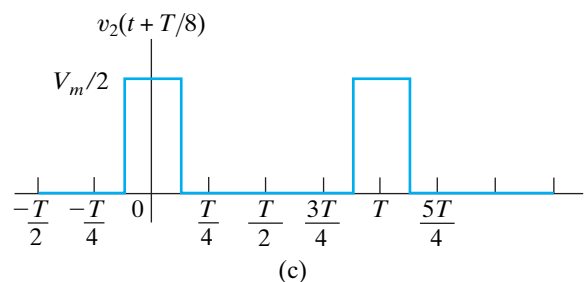
Figure P16.18



(a)



(b)



(c)

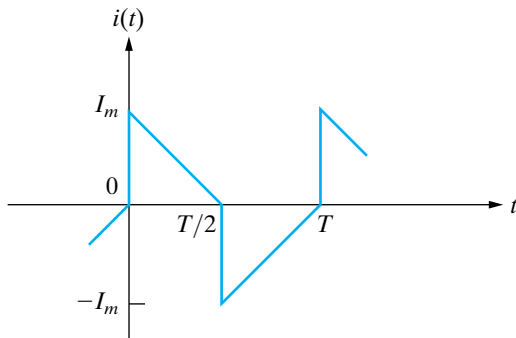
### Section 16.4

- 16.19** For each of the periodic functions in Fig. P16.3, derive the Fourier series for  $v(t)$  using the form of Eq. 16.38.
- 16.20** Derive the Fourier series for the periodic function described in Problem 16.12, using the form of Eq. 16.38.
- 16.21** Derive the Fourier series for the periodic function constructed in Problem 16.15, using the form of Eq. 16.38.



- 16.22** a) Derive the Fourier series for the periodic function shown in Fig. P16.22 when  $I_m = 5\pi^2$  A. Write the series in the form of Eq. 16.38.  
 b) Use the first five nonzero terms to estimate  $i(T/4)$ .

Figure P16.22



## Section 16.5

**16.23** Derive Eqs. 16.69 and 16.70.

- 16.24** a) Derive Eq. 16.71. *Hint:* Note that  $b_k = 4V_m/\pi k + k\omega_o RC a_k$ . Use this expression for  $b_k$  to find  $a_k^2 + b_k^2$  in terms of  $a_k$ . Then use the expression for  $a_k$  to derive Eq. 16.71.  
 b) Derive Eq. 16.72.

**16.25** Show that when we combine Eqs. 16.71 and 16.72 with Eqs. 16.38 and 16.39, the result is Eq. 16.58. *Hint:* Note from the definition of  $\beta_k$  that

$$\frac{a_k}{b_k} = -\tan \beta_k,$$

and from the definition of  $\theta_k$  that

$$\tan \theta_k = -\cot \beta_k.$$

Now use the trigonometric identity

$$\tan x = \cot(90 - x)$$

to show that  $\theta_k = 90 + \beta_k$ .

- 16.26** a) Show that for large values of  $C$ , Eq. 16.67 can be approximated by the expression

$$v_o(t) \approx \frac{-V_m T}{4RC} + \frac{V_m}{RC} t.$$

Note that this expression is the equation of the triangular wave for  $0 \leq t \leq T/2$ . *Hints:* (1) Let  $e^{-t/RC} \approx 1 - (t/RC)$  and  $e^{-T/2RC} \approx 1 - (T/2RC)$ ; (2) put the resulting expression over the common denominator  $2 - (T/2RC)$ ; (3) simplify the numerator; and (4) for large  $C$ , assume that  $T/2RC$  is much less than 2.

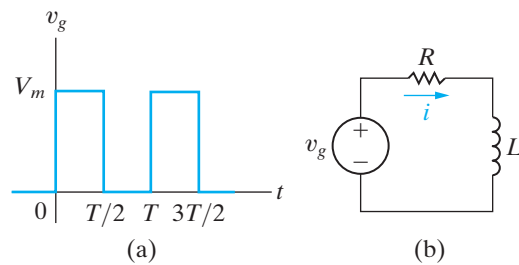
- b) Substitute the peak value of the triangular wave into the solution for Problem 16.13 (see Fig. P16.13(b)) and show that the result is Eq. 16.59.

**16.27** The square-wave voltage shown in Fig. P16.27(a) is applied to the circuit shown in Fig. P16.27(b).

**PSPICE  
MULTISIM**

- a) Find the Fourier series representation of the steady-state current  $i$ .  
 b) Find the steady-state expression for  $i$  by straightforward circuit analysis.

Figure P16.27

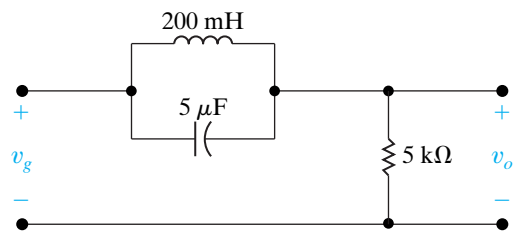


**16.28** The periodic square-wave voltage shown in Fig. P16.13(a) with  $V_m = 0.5\pi$  V and  $T = 10\pi$  ms is applied to the circuit shown in Fig. P16.28.

**PSPICE  
MULTISIM**

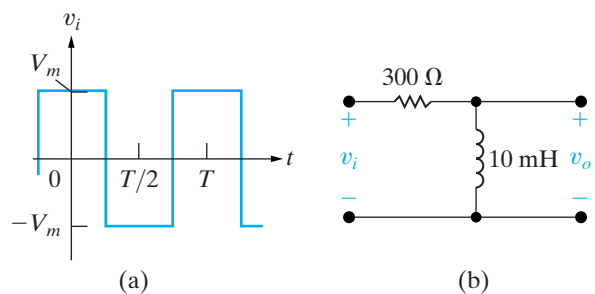
- a) Derive the first three nonzero terms in the Fourier series that represents the steady-state voltage  $v_o$ .  
 b) Which frequency component in the input voltage is eliminated from the output voltage? Explain why.

Figure P16.28



**16.29** The periodic square-wave voltage seen in Fig. P16.29(a) is applied to the circuit shown in Fig. P16.29(b). Derive the first three nonzero terms in the Fourier series that represents the steady-state voltage  $v_o$  if  $V_m = 30\pi$  V and the period of the input voltage is  $200\pi$   $\mu$ s.

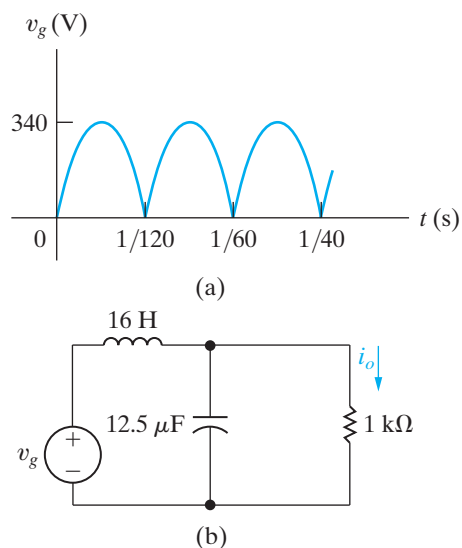
Figure P16.29



**16.30** The full-wave rectified sine-wave voltage shown in Fig. P16.30(a) is applied to the circuit shown in Fig. P16.30(b).

- Find the first five nonzero terms in the Fourier series representation of  $i_o$ .
- Does your solution for  $i_o$  make sense? Explain.

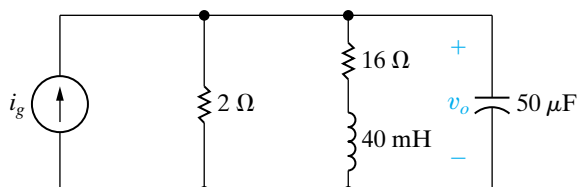
Figure P16.30



**16.31** The periodic current described below is used to energize the circuit shown in Fig. P16.31. Write the time-domain expression for the third-harmonic component in the expression for  $v_o$ .

$$\begin{aligned} i_g &= 100t \text{ A}, & -50 \text{ ms} \leq t \leq 50 \text{ ms}; \\ &= 5 \text{ A}, & 50 \text{ ms} \leq t \leq 200 \text{ ms}; \\ &= 25 - 100t \text{ A}, & 200 \text{ ms} \leq t \leq 300 \text{ ms}; \\ &= -5 \text{ A}, & 300 \text{ ms} \leq t \leq 450 \text{ ms}. \end{aligned}$$

Figure P16.31

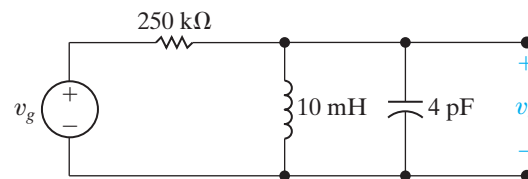


**16.32** A periodic voltage having a period of  $10\pi \mu\text{s}$  is given by the following Fourier series:

$$v_g = 150 \sum_{n=1,3,5,\dots}^{\infty} \frac{1}{n} \sin \frac{n\pi}{2} \cos n\omega_o t \text{ V.}$$

This periodic voltage is applied to the circuit shown in Fig. P16.32. Find the amplitude and phase angle of the components of  $v_o$  that have frequencies of 3 and 5 Mrad/s.

Figure P16.32

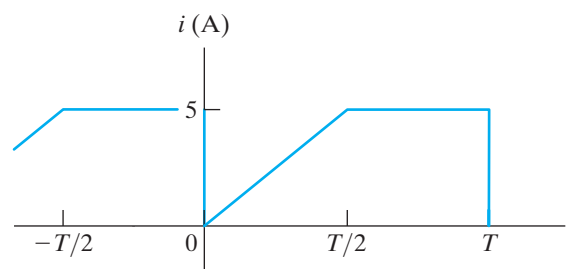


## Section 16.6

**16.33** The periodic current shown in Fig. P16.33 is applied to a  $2.5 \text{ k}\Omega$  resistor.

- Use the first three nonzero terms in the Fourier series representation of  $i(t)$  to estimate the average power dissipated in the  $2.5 \text{ k}\Omega$  resistor.
- Calculate the exact value of the average power dissipated in the  $2.5 \text{ k}\Omega$  resistor.
- What is the percentage of error in the estimated value of the average power?

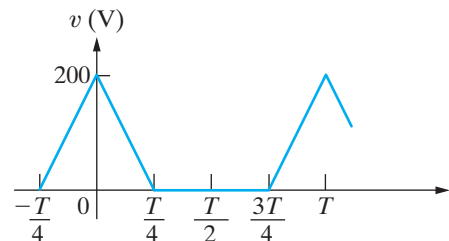
Figure P16.33



**16.34** The periodic voltage across a  $400 \Omega$  resistor is shown in Fig. P16.34.

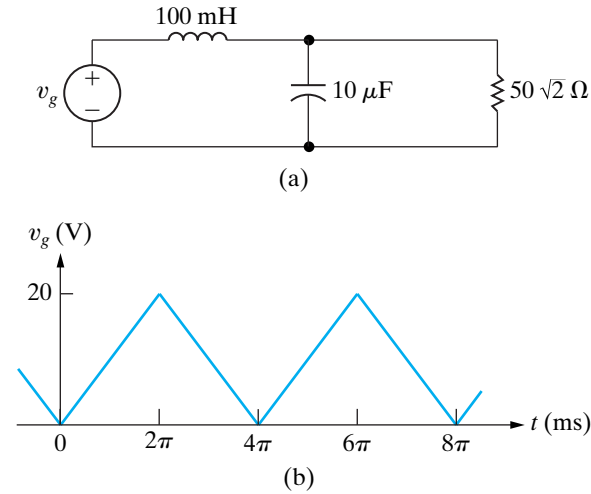
- Use the first three nonzero terms in the Fourier series representation of  $v(t)$  to estimate the average power dissipated in the  $400 \Omega$  resistor.
- Calculate the exact value of the average power dissipated in the  $400 \Omega$  resistor.
- What is the percentage error in the estimated value of the average power dissipated?

Figure P16.34



**16.35** The triangular-wave voltage source is applied to the circuit in Fig. P16.35(a). The triangular-wave voltage is shown in Fig. P16.35(b). Estimate the average power delivered to the  $50\sqrt{2} \Omega$  resistor when the circuit is in steady-state operation.

Figure P16.35



## Section 16.7

**16.36** The voltage and current at the terminals of a network are

$$v = 30 + 60 \cos 2000t + 20 \sin 8000t \text{ V,}$$

$$i = 3 + 4 \cos(2000t - 25^\circ) + \sin(8000t + 45^\circ) \text{ A.}$$

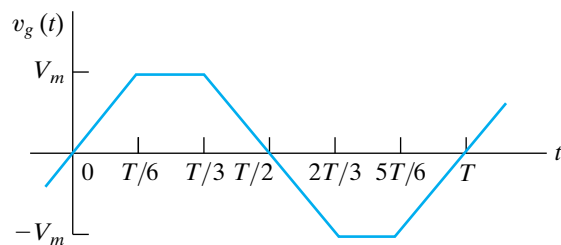
The current is in the direction of the voltage drop across the terminals.

- What is the average power at the terminals?
- What is the rms value of the voltage?
- What is the rms value of the current?

**16.37** a) Find the rms value of the voltage shown in Fig. P16.37 for  $V_m = 100 \text{ V}$ . Note that the Fourier series for this periodic voltage was found in Assessment Problem 16.3.

- Estimate the rms value of the voltage, using the first three nonzero terms in the Fourier series representation of  $v_g(t)$ .

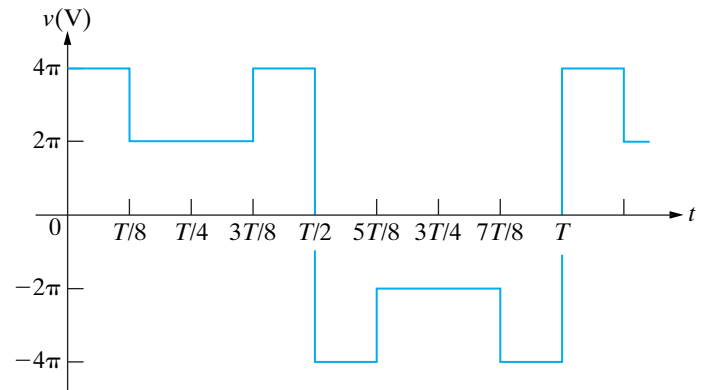
Figure P16.37



**16.38** a) Use the first three nonzero terms in the Fourier series approximation of the periodic voltage shown in Fig. P16.38 to estimate its rms value.

- Calculate the true rms value of the voltage.
- Calculate the percentage of error in the estimated value.

Figure P16.38

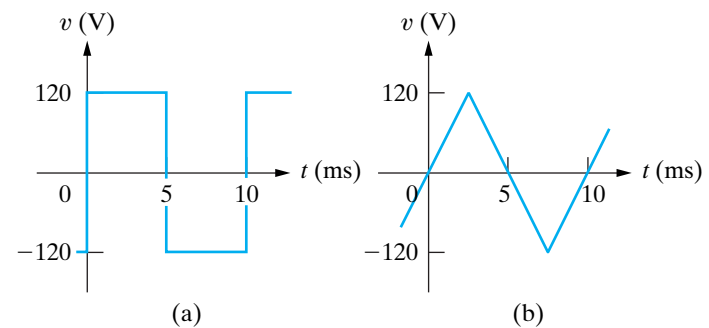


**16.39** a) Estimate the rms value of the periodic square-wave voltage shown in Fig. P16.39(a) by using the first five nonzero terms in the Fourier series representation of  $v(t)$ .

- Calculate the percentage of error in the estimation.

- Repeat parts (a) and (b) if the periodic square-wave voltage is replaced by the periodic triangular voltage shown in Fig. P16.39(b).

Figure P16.39

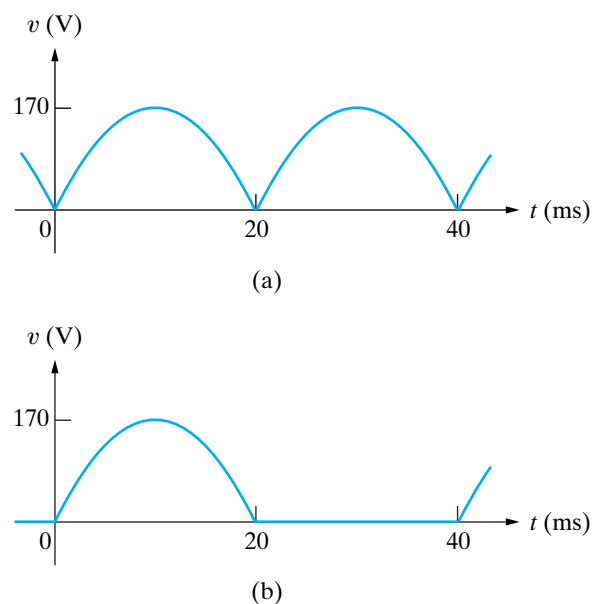


**16.40** a) Estimate the rms value of the full-wave rectified sinusoidal voltage shown in Fig. P16.40(a) by using the first three nonzero terms in the Fourier series representation of  $v(t)$ .

- Calculate the percentage of error in the estimation.

- Repeat (a) and (b) if the full-wave rectified sinusoidal voltage is replaced by the half-wave rectified sinusoidal voltage shown in Fig. P16.40(b).

Figure P16.40

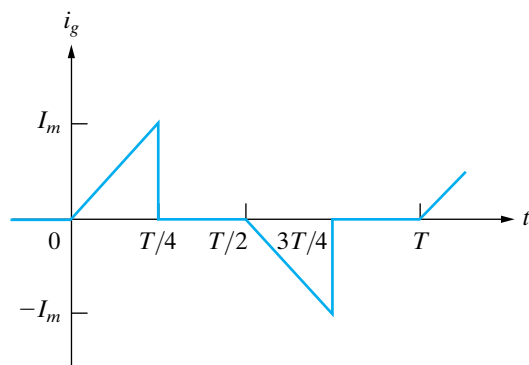


**16.41** Assume the periodic function described in Problem 16.14 is a current  $i$  with a peak amplitude of 3 A.

- Find the rms value of the current.
- If this current exists in a  $100\ \Omega$  resistor, what is the average power dissipated in the resistor?
- If  $i$  is approximated by using just the fundamental frequency term of its Fourier series, what is the average power delivered to the  $100\ \Omega$  resistor?
- What is the percentage of error in the estimation of the power dissipated?

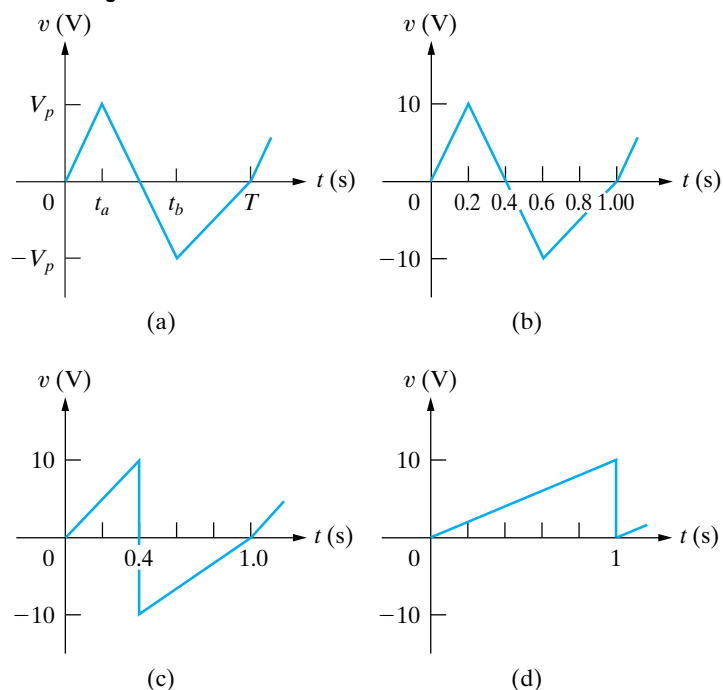
- 16.42**
- Derive the expressions for the Fourier coefficients for the periodic current shown in Fig. P16.42.
  - Write the first four nonzero terms of the series using the alternative trigonometric form given by Eq. 16.39.
  - Use the first four nonzero terms of the expression derived in (b) to estimate the rms value of  $i_g$ .
  - Find the exact rms value of  $i_g$ .
  - Calculate the percentage of error in the estimated rms value.

Figure P16.42



**16.43** The rms value of any periodic triangular wave having the form depicted in Fig. P16.43(a) is independent of  $t_a$  and  $t_b$ . Note that for the function to be single valued,  $t_a \leq t_b$ . The rms value is equal to  $V_p/\sqrt{3}$ . Verify this observation by finding the rms value of the three waveforms depicted in Fig. P16.43(b)–(d).

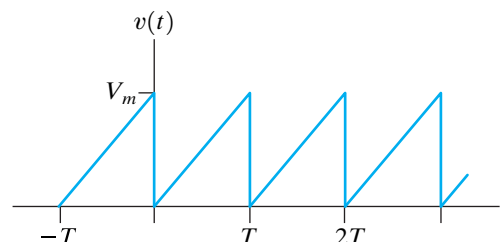
Figure P16.43



### Section 16.8

**16.44** Derive the expression for the complex Fourier coefficients for the periodic voltage shown in Fig. P16.44.

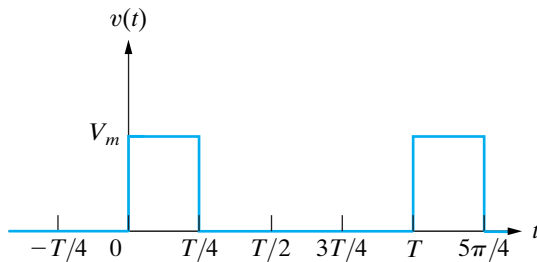
Figure P16.44



- 16.45**
- The periodic voltage in Problem 16.44 is applied to a  $25\ \Omega$  resistor. If  $V_m = 150\ \text{V}$  what is the average power delivered to the resistor?
  - Assume  $v(t)$  is approximated by a truncated exponential form of the Fourier series consisting of the first five nonzero terms, that is,  $n = 0, 1, 2, 3,$  and  $4$ . What is the rms value of the voltage, using this approximation?
  - If the approximation in part (b) is used to represent  $v$  what is the percentage of error in the calculated power?

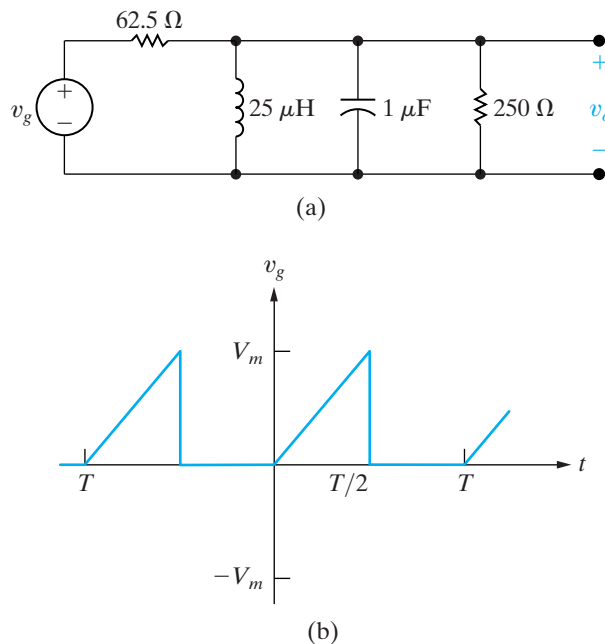
- 16.46** Use the exponential form of the Fourier series to write an expression for the voltage shown in Fig. P16.46.

Figure P16.46



- 16.47** The periodic voltage source in the circuit shown in Fig. P16.47(a) has the waveform shown in Fig. P16.47(b).
- Derive the expression for  $C_n$ .
  - Find the values of the complex coefficients  $C_0, C_{-1}, C_1, C_{-2}, C_2, C_{-3}, C_3, C_{-4}$ , and  $C_4$  for the input voltage  $v_g$  if  $V_m = 54 \text{ V}$  and  $T = 10\pi \mu\text{s}$ .
  - Repeat (b) for  $v_o$ .
  - Use the complex coefficients found in (c) to estimate the average power delivered to the  $250 \text{ k}\Omega$  resistor.

Figure P16.47

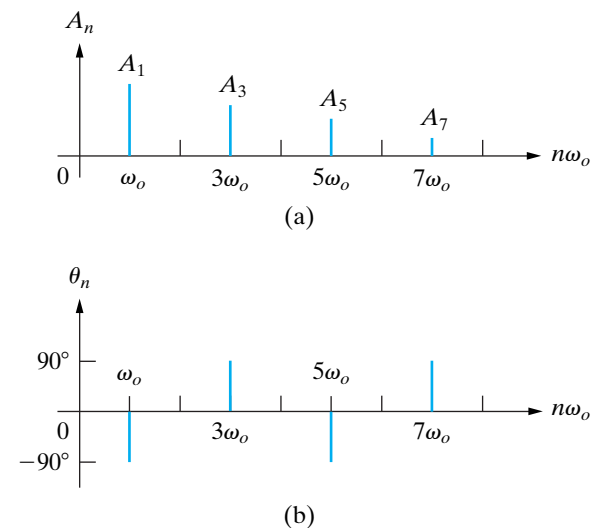


- 16.48**
- Find the rms value of the periodic voltage in Fig. P16.47(b).
  - Use the complex coefficients derived in Problem 16.47(b) to estimate the rms value of  $v_g$ .
  - What is the percentage of error in the estimated rms value of  $v_g$ ?

## Section 16.9

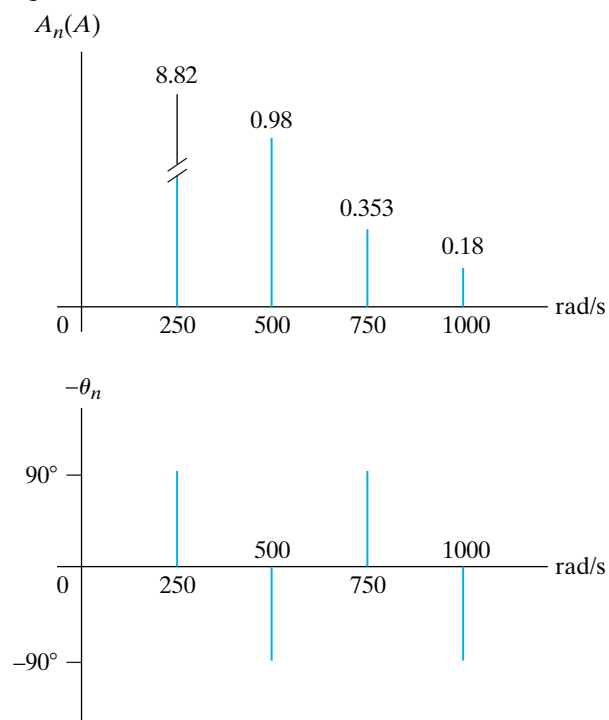
- 16.49**
- Make an amplitude and phase plot, based on Eq. 16.38, for the periodic voltage in Example 16.3. Assume  $V_m$  is 40 V. Plot both amplitude and phase versus  $n\omega_o$ , where  $n = 0, 1, 2, 3, \dots$
  - Repeat (a), but base the plots on Eq. 16.82.
- 16.50**
- Make an amplitude and phase plot, based on Eq. 16.38, for the periodic voltage in Problem 16.33. Plot both amplitude and phase versus  $n\omega_o$  where  $n = 0, 1, 2, \dots$
  - Repeat (a), but base the plots on Eq. 16.82.
- 16.51** A periodic voltage is represented by a truncated Fourier series. The amplitude and phase spectra are shown in Fig. P16.51(a) and (b), respectively.
- Write an expression for the periodic voltage using the form given by Eq. 16.38.
  - Is the voltage an even or odd function of  $t$ ?
  - Does the voltage have half-wave symmetry?
  - Does the voltage have quarter-wave symmetry?

Figure P16.51



- 16.52** A periodic function is represented by a Fourier series that has a finite number of terms. The amplitude and phase spectra are shown in Fig. P16.52(a) and (b), respectively.
- Write the expression for the periodic current using the form given by Eq. 16.38.
  - Is the current an even or odd function of  $t$ ?
  - Does the current have half-wave symmetry?
  - Calculate the rms value of the current in milliamperes.
  - Write the exponential form of the Fourier series.
  - Make the amplitude and phase spectra plots on the basis of the exponential series.

Figure P16.52

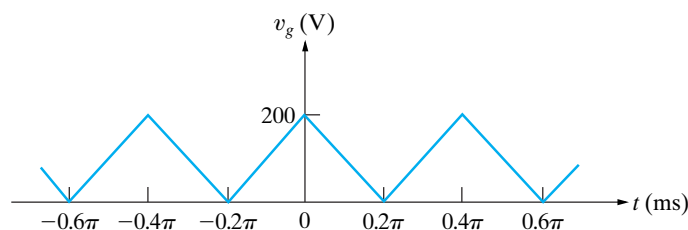


**16.53** The input signal to a unity-gain third-order high-pass Butterworth filter is a half-wave rectified sinusoidal voltage. The corner frequency of the filter is 2500 rad/s. The amplitude of the sinusoidal voltage is  $270\pi$  V and its period is  $400\pi$   $\mu$ s. Write the first three terms of the Fourier series that represents the steady-state output voltage of the filter.

### Sections 16.1–16.9

**16.54** The input signal to a unity-gain second-order low-pass Butterworth filter is the periodic triangular-wave voltage shown in Fig P16.54. The corner frequency of the filter is 2 krad/s. Write the first three terms of the Fourier series that represents the steady-state output voltage of the filter.

Figure P16.54



**16.55** The input signal to a unity-gain second-order low-pass Butterworth filter is a full-wave rectified sine wave with an amplitude of  $2.5\pi$  V and a fundamental

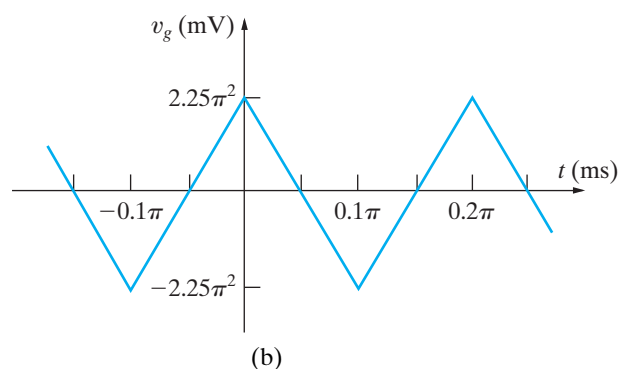
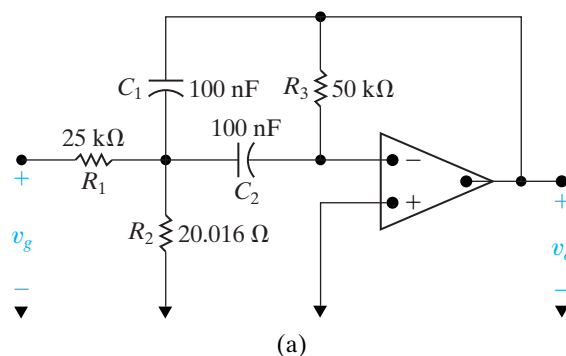
frequency of 5000 rad/s. The corner frequency of the filter is 1 krad/s. Write the first two terms in the Fourier series that represents the steady-state output voltage of the filter.

**16.56** The transfer function ( $V_o/V_g$ ) for the narrowband bandpass filter circuit in Fig. P16.56(a) is

$$H(s) = \frac{-K_o\beta s}{s^2 + \beta s + \omega_o^2}$$

- Find  $K_o$ ,  $\beta$ , and  $\omega_o^2$  as functions of the circuit parameters  $R_1$ ,  $R_2$ ,  $R_3$ ,  $C_1$ , and  $C_2$ .
- Write the first three terms in the Fourier series that represents  $v_o$  if  $v_g$  is the periodic voltage in Fig. P16.56(b).
- Predict the value of the quality factor for the filter by examining the result in part (b).
- Calculate the quality factor for the filter using  $\beta$  and  $\omega_o$  and compare the value to your prediction in part (c).

Figure P16.56



- 16.57**
- Find the values for  $K$ ,  $\beta$ , and  $\omega_o^2$  for the band-pass filter shown in Fig. 16.20(b).
  - Find the first three terms in the Fourier series for  $v_o$  in Fig. 16.20(b) if the input to the filter is the waveform shown in Fig. 16.20(a).

# CHAPTER 17

## CHAPTER CONTENTS

- 17.1 **The Derivation of the Fourier Transform** *p. 644*
- 17.2 **The Convergence of the Fourier Integral** *p. 646*
- 17.3 **Using Laplace Transforms to Find Fourier Transforms** *p. 648*
- 17.4 **Fourier Transforms in the Limit** *p. 651*
- 17.5 **Some Mathematical Properties** *p. 653*
- 17.6 **Operational Transforms** *p. 655*
- 17.7 **Circuit Applications** *p. 659*
- 17.8 **Parseval's Theorem** *p. 662*

## ✓ CHAPTER OBJECTIVES

- 1 Be able to calculate the Fourier transform of a function using any or all of the following:
  - The definition of the Fourier transform;
  - Laplace transforms;
  - Mathematical properties of the Fourier transform;
  - Operational transforms.
- 2 Know how to use the Fourier transform to find the response of a circuit.
- 3 Understand Parseval's theorem and be able to use it to answer questions about the energy contained within specific frequency bands.

# The Fourier Transform

In Chapter 16, we discussed the representation of a periodic function by means of a Fourier series. This series representation enables us to describe the periodic function in terms of the frequency-domain attributes of amplitude and phase. The Fourier transform extends this frequency-domain description to functions that are not periodic. Through the Laplace transform, we already introduced the idea of transforming an aperiodic function from the time domain to the frequency domain. You may wonder, then, why yet another type of transformation is necessary. Strictly speaking, the Fourier transform is not a new transform. It is a special case of the bilateral Laplace transform, with the real part of the complex frequency set equal to zero. However, in terms of physical interpretation, the Fourier transform is better viewed as a limiting case of a Fourier series. We present this point of view in Section 17.1, where we derive the Fourier transform equations.

The Fourier transform is more useful than the Laplace transform in certain communications theory and signal-processing situations. Although we cannot pursue the Fourier transform in depth, its introduction here seems appropriate while the ideas underlying the Laplace transform and the Fourier series are still fresh in your mind.



## Practical Perspective

### Filtering Digital Signals

It is common to use telephone lines to communicate information from one computer to another. As you may know, computers represent all information as collections of 1's and 0's. Usually the value 1 is represented as a voltage, usually 5 V, and 0 is represented as 0 V, as shown below.

The telephone line has a frequency response characteristic that is similar to a low pass filter. We can use Fourier transforms to understand the effect of transmitting a digital value using a telephone line that behaves like a filter.





## 17.1 The Derivation of the Fourier Transform

We begin the derivation of the Fourier transform, viewed as a limiting case of a Fourier series, with the exponential form of the series:

$$f(t) = \sum_{n=-\infty}^{\infty} C_n e^{jn\omega_0 t}, \quad (17.1)$$

where

$$C_n = \frac{1}{T} \int_{-T/2}^{T/2} f(t) e^{-jn\omega_0 t} dt. \quad (17.2)$$

In Eq. 17.2, we elected to start the integration at  $t_0 = -T/2$ .

Allowing the fundamental period  $T$  to increase without limit accomplishes the transition from a periodic to an aperiodic function. In other words, if  $T$  becomes infinite, the function never repeats itself and hence is aperiodic. As  $T$  increases, the separation between adjacent harmonic frequencies becomes smaller and smaller. In particular,

$$\Delta\omega = (n+1)\omega_0 - n\omega_0 = \omega_0 = \frac{2\pi}{T}, \quad (17.3)$$

and as  $T$  gets larger and larger, the incremental separation  $\Delta\omega$  approaches a differential separation  $d\omega$ . From Eq. 17.3,

$$\frac{1}{T} \rightarrow \frac{d\omega}{2\pi} \quad \text{as } T \rightarrow \infty. \quad (17.4)$$

As the period increases, the frequency moves from being a discrete variable to becoming a continuous variable, or

$$n\omega_0 \rightarrow \omega \quad \text{as } T \rightarrow \infty. \quad (17.5)$$

In terms of Eq. 17.2, as the period increases, the Fourier coefficients  $C_n$  get smaller. In the limit,  $C_n \rightarrow 0$  as  $T \rightarrow \infty$ . This result makes sense, because we expect the Fourier coefficients to vanish as the function loses its periodicity. Note, however, the limiting value of the product  $C_n T$ ; that is,

$$C_n T \rightarrow \int_{-\infty}^{\infty} f(t) e^{-j\omega t} dt \quad \text{as } T \rightarrow \infty. \quad (17.6)$$

In writing Eq. 17.6 we took advantage of the relationship in Eq. 17.5. The integral in Eq. 17.6 is the **Fourier transform** of  $f(t)$  and is denoted

Fourier transform ►

$$F(\omega) = \mathcal{F}\{f(t)\} = \int_{-\infty}^{\infty} f(t) e^{-j\omega t} dt. \quad (17.7)$$

We obtain an explicit expression for the inverse Fourier transform by investigating the limiting form of Eq. 17.1 as  $T \rightarrow \infty$ . We begin by multiplying and dividing by  $T$ :

$$f(t) = \sum_{n=-\infty}^{\infty} (C_n T) e^{jn\omega_0 t} \left( \frac{1}{T} \right). \quad (17.8)$$

As  $T \rightarrow \infty$ , the summation approaches integration,  $C_n T \rightarrow F(\omega)$ ,  $n\omega_0 \rightarrow \omega$ , and  $1/T \rightarrow d\omega/2\pi$ . Thus in the limit, Eq. 17.8 becomes

$$f(t) = \frac{1}{2\pi} \int_{-\infty}^{\infty} F(\omega) e^{j\omega t} d\omega. \quad (17.9)$$

◀ Inverse Fourier transform

Equations 17.7 and 17.9 define the Fourier transform. Equation 17.7 transforms the time-domain expression  $f(t)$  into its corresponding frequency-domain expression  $F(\omega)$ . Equation 17.9 defines the inverse operation of transforming  $F(\omega)$  into  $f(t)$ .

Let's now derive the Fourier transform of the pulse shown in Fig. 17.1. Note that this pulse corresponds to the periodic voltage in Example 16.6 if we let  $T \rightarrow \infty$ . The Fourier transform of  $v(t)$  comes directly from Eq. 17.7:

$$\begin{aligned} V(\omega) &= \int_{-\tau/2}^{\tau/2} V_m e^{-j\omega t} dt \\ &= V_m \frac{e^{-j\omega t}}{(-j\omega)} \Big|_{-\tau/2}^{\tau/2} \\ &= \frac{V_m}{-j\omega} \left( -2j \sin \frac{\omega\tau}{2} \right), \end{aligned} \quad (17.10)$$

which can be put in the form of  $(\sin x)/x$  by multiplying the numerator and denominator by  $\tau$ . Then,

$$V(\omega) = V_m \tau \frac{\sin \omega\tau/2}{\omega\tau/2}. \quad (17.11)$$

For the periodic train of voltage pulses in Example 16.6, the expression for the Fourier coefficients is

$$C_n = \frac{V_m \tau}{T} \frac{\sin n\omega_0\tau/2}{n\omega_0\tau/2}. \quad (17.12)$$

Comparing Eqs. 17.11 and 17.12 clearly shows that, as the time-domain function goes from periodic to aperiodic, the amplitude spectrum goes from a discrete line spectrum to a continuous spectrum. Furthermore, the envelope of the line spectrum has the same shape as the continuous spectrum. Thus, as  $T$  increases, the spectrum of lines gets denser and the amplitudes get smaller, but the envelope doesn't change shape. The physical interpretation of the Fourier transform  $V(\omega)$  is therefore a measure of the frequency content of  $v(t)$ . Figure 17.2 illustrates these observations. The amplitude spectrum plot is based on the assumption that  $\tau$  is constant and  $T$  is increasing.

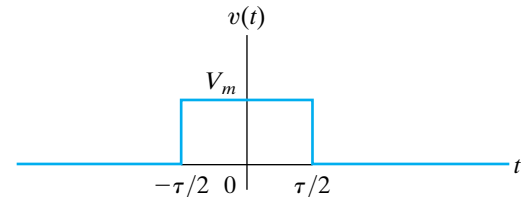
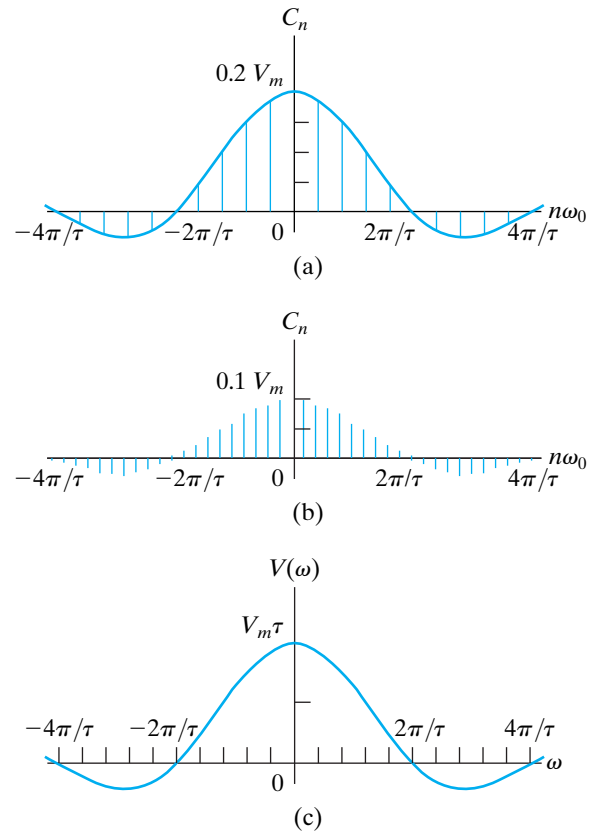


Figure 17.1 ▲ A voltage pulse.



**Figure 17.2** ▲ Transition of the amplitude spectrum as  $f(t)$  goes from periodic to aperiodic. (a)  $C_n$  versus  $n\omega_0$ ,  $T/\tau = 5$ ; (b)  $C_n$  versus  $n\omega_0$ ,  $T/\tau = 10$ ; (c)  $V(\omega)$  versus  $\omega$ .

## 17.2 The Convergence of the Fourier Integral

A function of time  $f(t)$  has a Fourier transform if the integral in Eq. 17.7 converges. If  $f(t)$  is a well-behaved function that differs from zero over a finite interval of time, convergence is no problem. *Well-behaved* implies that  $f(t)$  is single valued and encloses a finite area over the range of integration. In practical terms, all the pulses of finite duration that interest us are well-behaved functions. The evaluation of the Fourier transform of the rectangular pulse discussed in Section 17.1 illustrates this point.

If  $f(t)$  is different from zero over an infinite interval, the convergence of the Fourier integral depends on the behavior of  $f(t)$  as  $t \rightarrow \infty$ . A single-valued function that is nonzero over an infinite interval has a Fourier transform if the integral

$$\int_{-\infty}^{\infty} |f(t)| dt$$

exists and if any discontinuities in  $f(t)$  are finite. An example is the decaying exponential function illustrated in Fig. 17.3. The Fourier transform of  $f(t)$  is

$$\begin{aligned} F(\omega) &= \int_{-\infty}^{\infty} f(t)e^{-j\omega t} dt = \int_0^{\infty} Ke^{-at}e^{-j\omega t} dt \\ &= \left. \frac{Ke^{-(a+j\omega)t}}{-(a+j\omega)} \right|_0^{\infty} = \frac{K}{-(a+j\omega)}(0-1) \\ &= \frac{K}{a+j\omega}, \quad a > 0. \end{aligned} \quad (17.13)$$

A third important group of functions have great practical interest but do not in a strict sense have a Fourier transform. For example, the integral in Eq. 17.7 doesn't converge if  $f(t)$  is a constant. The same can be said if  $f(t)$  is a sinusoidal function,  $\cos \omega_0 t$ , or a step function,  $Ku(t)$ . These functions are of great interest in circuit analysis, but, to include them in Fourier analysis, we must resort to some mathematical subterfuge. First, we create a function in the time domain that has a Fourier transform and at the same time can be made arbitrarily close to the function of interest. Next, we find the Fourier transform of the approximating function and then evaluate the limiting value of  $F(\omega)$  as this function approaches  $f(t)$ . Last, we define the limiting value of  $F(\omega)$  as the Fourier transform of  $f(t)$ .

Let's demonstrate this technique by finding the Fourier transform of a constant. We can approximate a constant with the exponential function

$$f(t) = Ae^{-\epsilon|t|}, \quad \epsilon > 0. \quad (17.14)$$

As  $\epsilon \rightarrow 0$ ,  $f(t) \rightarrow A$ . Figure 17.4 shows the approximation graphically. The Fourier transform of  $f(t)$  is

$$F(\omega) = \int_{-\infty}^0 Ae^{\epsilon t}e^{-j\omega t} dt + \int_0^{\infty} Ae^{-\epsilon t}e^{-j\omega t} dt. \quad (17.15)$$

Carrying out the integration called for in Eq. 17.15 yields

$$F(\omega) = \frac{A}{\epsilon - j\omega} + \frac{A}{\epsilon + j\omega} = \frac{2\epsilon A}{\epsilon^2 + \omega^2}. \quad (17.16)$$

The function given by Eq. 17.16 generates an impulse function at  $\omega = 0$  as  $\epsilon \rightarrow 0$ . You can verify this result by showing that (1)  $F(\omega)$  approaches infinity at  $\omega = 0$  as  $\epsilon \rightarrow 0$ ; (2) the width of  $F(\omega)$  approaches zero as  $\epsilon \rightarrow 0$ ; and (3) the area under  $F(\omega)$  is independent of  $\epsilon$ . The area under  $F(\omega)$  is the strength of the impulse and is

$$\int_{-\infty}^{\infty} \frac{2\epsilon A}{\epsilon^2 + \omega^2} d\omega = 4\epsilon A \int_0^{\infty} \frac{d\omega}{\epsilon^2 + \omega^2} = 2\pi A. \quad (17.17)$$

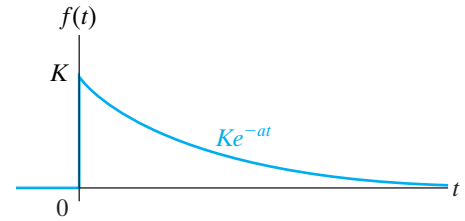


Figure 17.3 ▲ The decaying exponential function  $Ke^{-at}u(t)$ .

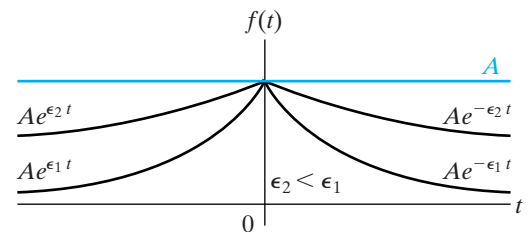


Figure 17.4 ▲ The approximation of a constant with an exponential function.

In the limit,  $f(t)$  approaches a constant  $A$ , and  $F(\omega)$  approaches an impulse function  $2\pi A\delta(\omega)$ . Therefore, the Fourier transform of a constant  $A$  is defined as  $2\pi A\delta(\omega)$ , or

$$\mathcal{F}\{A\} = 2\pi A\delta(\omega). \quad (17.18)$$

In Section 17.4, we say more about Fourier transforms defined through a limit process. Before doing so, in Section 17.3 we show how to take advantage of the Laplace transform to find the Fourier transform of functions for which the Fourier integral converges.

## ASSESSMENT PROBLEMS

**Objective 1—Be able to calculate the Fourier transform of a function**

**17.1** Use the defining integral to find the Fourier transform of the following functions:

- a)  $f(t) = -A, \quad -\tau/2 \leq t < 0;$   
 $f(t) = A, \quad 0 < t \leq \tau/2;$   
 $f(t) = 0$  elsewhere.  
 b)  $f(t) = 0, \quad t < 0;$   
 $f(t) = te^{-at}, \quad t \geq 0, a > 0.$

**Answer:** (a)  $-j\left(\frac{2A}{\omega}\right)\left(1 - \cos\frac{\omega\tau}{2}\right);$   
 (b)  $\frac{1}{(a + j\omega)^2}.$

*NOTE: Also try Chapter Problems 17.1 and 17.2.*

**17.2** The Fourier transform of  $f(t)$  is given by

$$F(\omega) = 0, \quad -\infty \leq \omega < -3;$$

$$F(\omega) = 4, \quad -3 < \omega < -2;$$

$$F(\omega) = 1, \quad -2 < \omega < 2;$$

$$F(\omega) = 4, \quad 2 < \omega < 3;$$

$$F(\omega) = 0, \quad 3 < \omega \leq \infty.$$

Find  $f(t)$ .

**Answer:**  $f(t) = \frac{1}{\pi t}(4 \sin 3t - 3 \sin 2t).$

## 17.3 Using Laplace Transforms to Find Fourier Transforms

We can use a table of unilateral, or one-sided, Laplace transform pairs to find the Fourier transform of functions for which the Fourier integral converges. The Fourier integral converges when all the poles of  $F(s)$  lie in the left half of the  $s$  plane. Note that if  $F(s)$  has poles in the right half of the  $s$  plane or along the imaginary axis,  $f(t)$  does not satisfy the constraint that  $\int_{-\infty}^{\infty} |f(t)| dt$  exists.

The following rules apply to the use of Laplace transforms to find the Fourier transforms of such functions.

1. If  $f(t)$  is zero for  $t \leq 0^-$ , we obtain the Fourier transform of  $f(t)$  from the Laplace transform of  $f(t)$  simply by replacing  $s$  by  $j\omega$ . Thus

$$\mathcal{F}\{f(t)\} = \mathcal{L}\{f(t)\}_{s=j\omega}. \quad (17.19)$$

For example, say that

$$f(t) = 0, \quad t \leq 0^-;$$

$$f(t) = e^{-at} \cos \omega_0 t, \quad t \geq 0^+.$$

Then

$$\mathcal{F}\{f(t)\} = \left. \frac{s + a}{(s + a)^2 + \omega_0^2} \right|_{s=j\omega} = \frac{j\omega + a}{(j\omega + a)^2 + \omega_0^2}.$$

2. Because the range of integration on the Fourier integral goes from  $-\infty$  to  $+\infty$ , the Fourier transform of a negative-time function exists. A negative-time function is nonzero for negative values of time and zero for positive values of time. To find the Fourier transform of such a function, we proceed as follows. First, we reflect the negative-time function over to the positive-time domain and then find its one-sided Laplace transform. We obtain the Fourier transform of the original time function by replacing  $s$  with  $-j\omega$ . Therefore, when  $f(t) = 0$  for  $t \geq 0^+$ ,

$$\mathcal{F}\{f(t)\} = \mathcal{L}\{f(-t)\}_{s=-j\omega}. \quad (17.20)$$

For example, if

$$f(t) = 0, \quad (\text{for } t \geq 0^+);$$

$$f(t) = e^{at} \cos \omega_0 t, \quad (\text{for } t \leq 0^-).$$

then

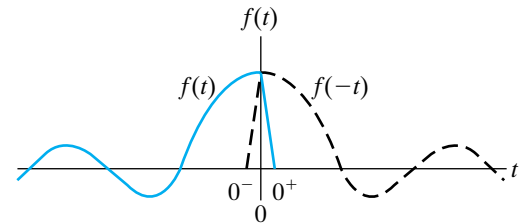
$$f(-t) = 0, \quad (\text{for } t \leq 0^-);$$

$$f(-t) = e^{-at} \cos \omega_0 t, \quad (\text{for } t \geq 0^+).$$

Both  $f(t)$  and its mirror image are plotted in Fig. 17.5.

The Fourier transform of  $f(t)$  is

$$\begin{aligned} \mathcal{F}\{f(t)\} &= \mathcal{L}\{f(-t)\}_{s=-j\omega} = \left. \frac{s + a}{(s + a)^2 + \omega_0^2} \right|_{s=-j\omega} \\ &= \frac{-j\omega + a}{(-j\omega + a)^2 + \omega_0^2}. \end{aligned}$$



**Figure 17.5** ▲ The reflection of a negative-time function over to the positive-time domain.

3. Functions that are nonzero over all time can be resolved into positive- and negative-time functions. We use Eqs. 17.19 and 17.20 to find the

Fourier transform of the positive- and negative-time functions, respectively. The Fourier transform of the original function is the sum of the two transforms. Thus if we let

$$f^+(t) = f(t) \quad (\text{for } t > 0),$$

$$f^-(t) = f(t) \quad (\text{for } t < 0),$$

then

$$f(t) = f^+(t) + f^-(t)$$

and

$$\begin{aligned} \mathcal{F}\{f(t)\} &= \mathcal{F}\{f^+(t)\} + \mathcal{F}\{f^-(t)\} \\ &= \mathcal{L}\{f^+(t)\}_{s=j\omega} + \mathcal{L}\{f^-(t)\}_{s=-j\omega}. \end{aligned} \quad (17.21)$$

An example of using Eq. 17.21 involves finding the Fourier transform of  $e^{-a|t|}$ . For the original function, the positive- and negative-time functions are

$$f^+(t) = e^{-at} \quad \text{and} \quad f^-(t) = e^{at}.$$

Then

$$\mathcal{L}\{f^+(t)\} = \frac{1}{s+a},$$

$$\mathcal{L}\{f^-(t)\} = \frac{1}{s+a}.$$

Therefore, from Eq. 17.21,

$$\begin{aligned} \mathcal{F}\{e^{-a|t|}\} &= \frac{1}{s+a} \Big|_{s=j\omega} + \frac{1}{s+a} \Big|_{s=-j\omega} \\ &= \frac{1}{j\omega+a} + \frac{1}{-j\omega+a} \\ &= \frac{2a}{\omega^2+a^2}. \end{aligned}$$

If  $f(t)$  is even, Eq. 17.21 reduces to

$$\mathcal{F}\{f(t)\} = \mathcal{L}\{f(t)\}_{s=j\omega} + \mathcal{L}\{f(t)\}_{s=-j\omega}. \quad (17.22)$$

If  $f(t)$  is odd, then Eq. 17.21 becomes

$$\mathcal{F}\{f(t)\} = \mathcal{L}\{f(t)\}_{s=j\omega} - \mathcal{L}\{f(t)\}_{s=-j\omega}. \quad (17.23)$$

**ASSESSMENT PROBLEM**

**Objective 1—Be able to calculate the Fourier transform of a function**

**17.3** Find the Fourier transform of each function. In each case,  $a$  is a positive real constant.

- a)  $f(t) = 0, \quad t < 0,$   
 $f(t) = e^{-at} \sin \omega_0 t, \quad t \geq 0.$
- b)  $f(t) = 0, \quad t > 0,$   
 $f(t) = -te^{at}, \quad t \leq 0.$
- c)  $f(t) = te^{-at}, \quad t \geq 0,$   
 $f(t) = te^{at}, \quad t \leq 0.$

- Answer:** (a)  $\frac{\omega_0}{(a + j\omega)^2 + \omega_0^2};$   
 (b)  $\frac{1}{(a - j\omega)^2};$   
 (c)  $\frac{-j4a\omega}{(a^2 + \omega^2)^2}.$

*NOTE: Also try Chapter Problem 17.5.*

## 17.4 Fourier Transforms in the Limit

As we pointed out in Section 17.2, the Fourier transforms of several practical functions must be defined by a limit process. We now return to these types of functions and develop their transforms.

### The Fourier Transform of a Signum Function

We showed that the Fourier transform of a constant  $A$  is  $2\pi A\delta(\omega)$  in Eq. 17.18. The next function of interest is the signum function, defined as  $+1$  for  $t > 0$  and  $-1$  for  $t < 0$ . The signum function is denoted  $\text{sgn}(t)$  and can be expressed in terms of unit-step functions, or

$$\text{sgn}(t) = u(t) - u(-t). \tag{17.24}$$

Figure 17.6 shows the function graphically.

To find the Fourier transform of the signum function, we first create a function that approaches the signum function in the limit:

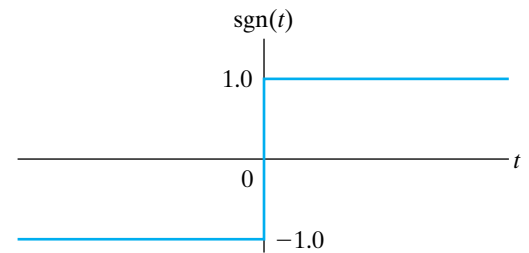
$$\text{sgn}(t) = \lim_{\epsilon \rightarrow 0} [e^{-\epsilon t} u(t) - e^{\epsilon t} u(-t)], \quad \epsilon > 0. \tag{17.25}$$

The function inside the brackets, plotted in Fig. 17.7, has a Fourier transform because the Fourier integral converges. Because  $f(t)$  is an odd function, we use Eq. 17.23 to find its Fourier transform:

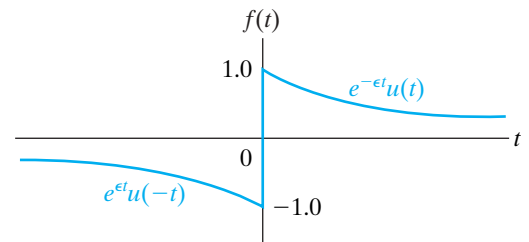
$$\begin{aligned} \mathcal{F}\{f(t)\} &= \frac{1}{s + \epsilon} \Big|_{s=j\omega} - \frac{1}{s + \epsilon} \Big|_{s=-j\omega} \\ &= \frac{1}{j\omega + \epsilon} - \frac{1}{-j\omega + \epsilon} \\ &= \frac{-2j\omega}{\omega^2 + \epsilon^2}. \end{aligned} \tag{17.26}$$

As  $\epsilon \rightarrow 0, f(t) \rightarrow \text{sgn}(t)$ , and  $\mathcal{F}\{f(t)\} \rightarrow 2/j\omega$ . Therefore,

$$\mathcal{F}\{\text{sgn}(t)\} = \frac{2}{j\omega}. \tag{17.27}$$



**Figure 17.6** ▲ The signum function.



**Figure 17.7** ▲ A function that approaches  $\text{sgn}(t)$  as  $\epsilon$  approaches zero.



### The Fourier Transform of a Unit Step Function

To find the Fourier transform of a unit step function, we use Eqs. 17.18 and 17.27. We do so by recognizing that the unit-step function can be expressed as

$$u(t) = \frac{1}{2} + \frac{1}{2} \operatorname{sgn}(t). \quad (17.28)$$

Thus,

$$\begin{aligned} \mathcal{F}\{u(t)\} &= \mathcal{F}\left\{\frac{1}{2}\right\} + \mathcal{F}\left\{\frac{1}{2} \operatorname{sgn}(t)\right\} \\ &= \pi\delta(\omega) + \frac{1}{j\omega}. \end{aligned} \quad (17.29)$$

### The Fourier Transform of a Cosine Function

To find the Fourier transform of  $\cos \omega_0 t$ , we return to the inverse-transform integral of Eq. 17.9 and observe that if

$$F(\omega) = 2\pi\delta(\omega - \omega_0), \quad (17.30)$$

then

$$f(t) = \frac{1}{2\pi} \int_{-\infty}^{\infty} [2\pi\delta(\omega - \omega_0)] e^{j\omega t} d\omega. \quad (17.31)$$

Using the sifting property of the impulse function, we reduce Eq. (17.31) to

$$f(t) = e^{j\omega_0 t}. \quad (17.32)$$

Then, from Eqs. 17.30 and 17.32,

$$\mathcal{F}\{e^{j\omega_0 t}\} = 2\pi\delta(\omega - \omega_0). \quad (17.33)$$

We now use Eq. 17.33 to find the Fourier transform of  $\cos \omega_0 t$ , because

$$\cos \omega_0 t = \frac{e^{j\omega_0 t} + e^{-j\omega_0 t}}{2}. \quad (17.34)$$

Thus,

$$\begin{aligned} \mathcal{F}\{\cos \omega_0 t\} &= \frac{1}{2} (\mathcal{F}\{e^{j\omega_0 t}\} + \mathcal{F}\{e^{-j\omega_0 t}\}) \\ &= \frac{1}{2} [2\pi\delta(\omega - \omega_0) + 2\pi\delta(\omega + \omega_0)] \\ &= \pi\delta(\omega - \omega_0) + \pi\delta(\omega + \omega_0). \end{aligned} \quad (17.35)$$

The Fourier transform of  $\sin \omega_0 t$  involves similar manipulation, which we leave for Problem 17.4. Table 17.1 presents a summary of the transform pairs of the important elementary functions.

We now turn to the properties of the Fourier transform that enhance our ability to describe aperiodic time-domain behavior in terms of frequency-domain behavior.

**TABLE 17.1** Fourier Transforms of Elementary Functions

Type	$f(t)$	$F(\omega)$
impulse	$\delta(t)$	1
constant	$A$	$2\pi A\delta(\omega)$
signum	$\text{sgn}(t)$	$2/j\omega$
step	$u(t)$	$\pi\delta(\omega) + 1/j\omega$
positive-time exponential	$e^{-at}u(t)$	$1/(a + j\omega), a > 0$
negative-time exponential	$e^{at}u(-t)$	$1/(a - j\omega), a > 0$
positive- and negative-time exponential	$e^{-a t }$	$2a/(a^2 + \omega^2), a > 0$
complex exponential	$e^{j\omega_0 t}$	$2\pi\delta(\omega - \omega_0)$
cosine	$\cos \omega_0 t$	$\pi[\delta(\omega + \omega_0) + \delta(\omega - \omega_0)]$
sine	$\sin \omega_0 t$	$j\pi[\delta(\omega + \omega_0) - \delta(\omega - \omega_0)]$

## 17.5 Some Mathematical Properties

The first mathematical property we call to your attention is that  $F(\omega)$  is a complex quantity and can be expressed in either rectangular or polar form. Thus from the defining integral,

$$\begin{aligned}
 F(\omega) &= \int_{-\infty}^{\infty} f(t)e^{-j\omega t} dt \\
 &= \int_{-\infty}^{\infty} f(t)(\cos \omega t - j \sin \omega t) dt \\
 &= \int_{-\infty}^{\infty} f(t) \cos \omega t dt - j \int_{-\infty}^{\infty} f(t) \sin \omega t dt. \quad (17.36)
 \end{aligned}$$

Now we let

$$A(\omega) = \int_{-\infty}^{\infty} f(t) \cos \omega t dt \quad (17.37)$$

$$B(\omega) = - \int_{-\infty}^{\infty} f(t) \sin \omega t dt. \quad (17.38)$$

Thus, using the definitions given by Eqs. 17.37 and 17.38 in Eq. 17.36, we get

$$F(\omega) = A(\omega) + jB(\omega) = |F(\omega)|e^{j\theta(\omega)}. \quad (17.39)$$

The following observations about  $F(\omega)$  are pertinent:

- The real part of  $F(\omega)$ —that is,  $A(\omega)$ —is an even function of  $\omega$ ; in other words,  $A(\omega) = A(-\omega)$ .
- The imaginary part of  $F(\omega)$ —that is,  $B(\omega)$ —is an odd function of  $\omega$ ; in other words,  $B(\omega) = -B(-\omega)$ .
- The magnitude of  $F(\omega)$ —that is,  $\sqrt{A^2(\omega) + B^2(\omega)}$ —is an even function of  $\omega$ .
- The phase angle of  $F(\omega)$ —that is,  $\theta(\omega) = \tan^{-1}B(\omega)/A(\omega)$ —is an odd function of  $\omega$ .
- Replacing  $\omega$  by  $-\omega$  generates the conjugate of  $F(\omega)$ ; in other words,  $F(-\omega) = F^*(\omega)$ .

Hence, if  $f(t)$  is an even function,  $F(\omega)$  is real, and if  $f(t)$  is an odd function,  $F(\omega)$  is imaginary. If  $f(t)$  is even, from Eqs. 17.37 and 17.38,

$$A(\omega) = 2 \int_0^{\infty} f(t) \cos \omega t \, dt \quad (17.40)$$

and

$$B(\omega) = 0. \quad (17.41)$$

If  $f(t)$  is an odd function,

$$A(\omega) = 0 \quad (17.42)$$

and

$$B(\omega) = -2 \int_0^{\infty} f(t) \sin \omega t \, dt. \quad (17.43)$$

We leave the derivations of Eqs. 17.40–17.43 for you as Problems 17.10 and 17.11.

If  $f(t)$  is an even function, its Fourier transform is an even function, and if  $f(t)$  is an odd function, its Fourier transform is an odd function. Moreover, if  $f(t)$  is an even function, from the inverse Fourier integral,

$$\begin{aligned} f(t) &= \frac{1}{2\pi} \int_{-\infty}^{\infty} F(\omega) e^{j\omega t} \, d\omega = \frac{1}{2\pi} \int_{-\infty}^{\infty} A(\omega) e^{j\omega t} \, d\omega \\ &= \frac{1}{2\pi} \int_{-\infty}^{\infty} A(\omega) (\cos \omega t + j \sin \omega t) \, d\omega \\ &= \frac{1}{2\pi} \int_{-\infty}^{\infty} A(\omega) \cos \omega t \, d\omega + 0 \\ &= \frac{2}{2\pi} \int_0^{\infty} A(\omega) \cos \omega t \, d\omega. \end{aligned} \quad (17.44)$$

Now compare Eq. 17.44 with Eq. 17.40. Note that, except for a factor of  $1/2\pi$ , these two equations have the same form. Thus, the waveforms of  $A(\omega)$  and  $f(t)$  become interchangeable if  $f(t)$  is an even function. For example, we have already observed that a rectangular pulse in the time domain produces a frequency spectrum of the form  $(\sin \omega)/\omega$ . Specifically, Eq. 17.11 expresses the Fourier transform of the voltage pulse shown in Fig. 17.1. Hence a rectangular pulse in the frequency domain must be generated by a time-domain function of the form  $(\sin t)/t$ . We can illustrate this requirement by finding the time-domain function  $f(t)$  corresponding to the frequency spectrum shown in Fig. 17.8. From Eq. 17.44,

$$\begin{aligned} f(t) &= \frac{2}{2\pi} \int_0^{\omega_0/2} M \cos \omega t \, d\omega = \frac{2M}{2\pi} \left( \frac{\sin \omega t}{t} \right) \Big|_0^{\omega_0/2} \\ &= \frac{1}{2\pi} \left( M \frac{\sin \omega_0 t/2}{t/2} \right) \\ &= \frac{1}{2\pi} \left( M \omega_0 \frac{\sin \omega_0 t/2}{\omega_0 t/2} \right). \end{aligned} \quad (17.45)$$

We say more about the frequency spectrum of a rectangular pulse in the time domain versus the rectangular frequency spectrum of  $(\sin t)/t$  after we introduce Parseval's theorem.

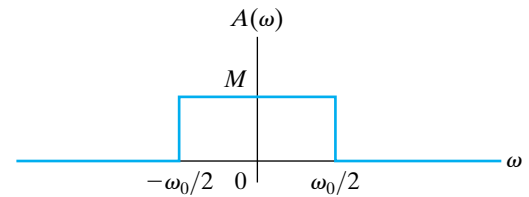


Figure 17.8 ▲ A rectangular frequency spectrum.

## 17.6 Operational Transforms

Fourier transforms, like Laplace transforms, can be classified as functional and operational. So far, we have concentrated on the functional transforms. We now discuss some of the important operational transforms. With regard to the Laplace transform, these operational transforms are similar to those discussed in Chapter 12. Hence we leave their proofs to you as Problems 17.12–17.19.

### Multiplication by a Constant

From the defining integral, if

$$\mathcal{F}\{f(t)\} = F(\omega),$$

then

$$\mathcal{F}\{Kf(t)\} = KF(\omega). \quad (17.46)$$

Thus, multiplication of  $f(t)$  by a constant corresponds to multiplying  $F(\omega)$  by that same constant.

### Addition (Subtraction)

Addition (subtraction) in the time domain translates into addition (subtraction) in the frequency domain. Thus if

$$\mathcal{F}\{f_1(t)\} = F_1(\omega),$$

$$\mathcal{F}\{f_2(t)\} = F_2(\omega),$$

$$\mathcal{F}\{f_3(t)\} = F_3(\omega),$$

then

$$\mathcal{F}\{f_1(t) - f_2(t) + f_3(t)\} = F_1(\omega) - F_2(\omega) + F_3(\omega), \quad (17.47)$$

which is derived by substituting the algebraic sum of time-domain functions into the defining integral.

### Differentiation

The Fourier transform of the first derivative of  $f(t)$  is

$$\mathcal{F}\left\{\frac{df(t)}{dt}\right\} = j\omega F(\omega). \quad (17.48)$$

The  $n$ th derivative of  $f(t)$  is

$$\mathcal{F}\left\{\frac{d^n f(t)}{dt^n}\right\} = (j\omega)^n F(\omega). \quad (17.49)$$

Equations 17.48 and 17.49 are valid if  $f(t)$  is zero at  $\pm\infty$ .

### Integration

If

$$g(t) = \int_{-\infty}^t f(x) dx,$$

then

$$\mathcal{F}\{g(t)\} = \frac{F(\omega)}{j\omega}. \quad (17.50)$$

Equation 17.50 is valid if

$$\int_{-\infty}^{\infty} f(x) dx = 0.$$

## Scale Change

Dimensionally, time and frequency are reciprocals. Therefore, when time is stretched out, frequency is compressed (and vice versa), as reflected in the functional transform

$$\mathcal{F}\{f(at)\} = \frac{1}{a} F\left(\frac{\omega}{a}\right), \quad a > 0. \quad (17.51)$$

Note that when  $0 < a < 1.0$ , time is stretched out, whereas when  $a > 1.0$ , time is compressed.

## Translation in the Time Domain

The effect of translating a function in the time domain is to alter the phase spectrum and leave the amplitude spectrum untouched. Thus

$$\mathcal{F}\{f(t - a)\} = e^{-j\omega a} F(\omega). \quad (17.52)$$

If  $a$  is positive in Eq. 17.52, the time function is delayed, and if  $a$  is negative, the time function is advanced.

## Translation in the Frequency Domain

Translation in the frequency domain corresponds to multiplication by the complex exponential in the time domain:

$$\mathcal{F}\{e^{j\omega_0 t} f(t)\} = F(\omega - \omega_0). \quad (17.53)$$

## Modulation

Amplitude modulation is the process of varying the amplitude of a sinusoidal carrier. If the modulating signal is denoted  $f(t)$ , the modulated carrier becomes  $f(t) \cos \omega_0 t$ . The amplitude spectrum of this carrier is one-half the amplitude spectrum of  $f(t)$  centered at  $\pm\omega_0$ , that is,

$$\mathcal{F}\{f(t) \cos \omega_0 t\} = \frac{1}{2} F(\omega - \omega_0) + \frac{1}{2} F(\omega + \omega_0). \quad (17.54)$$

## Convolution in the Time Domain

Convolution in the time domain corresponds to multiplication in the frequency domain. In other words,

$$y(t) = \int_{-\infty}^{\infty} x(\lambda)h(t - \lambda) d\lambda$$

becomes

$$\mathcal{F}\{y(t)\} = Y(\omega) = X(\omega)H(\omega). \quad (17.55)$$

Equation 17.55 is important in applications of the Fourier transform, because it states that the transform of the response function  $Y(\omega)$  is the product of the input transform  $X(\omega)$  and the system function  $H(\omega)$ . We say more about this relationship in Section 17.7.

## Convolution in the Frequency Domain

Convolution in the frequency domain corresponds to finding the Fourier transform of the product of two time functions. Thus if

$$f(t) = f_1(t)f_2(t),$$

then

$$F(\omega) = \frac{1}{2\pi} \int_{-\infty}^{\infty} F_1(u)F_2(\omega - u) du. \quad (17.56)$$

Table 17.2 summarizes these ten operational transforms and another operational transform that we introduce in Problem 17.18.

**TABLE 17.2 Operational Transforms**

$f(t)$	$F(\omega)$
$Kf(t)$	$KF(\omega)$
$f_1(t) - f_2(t) + f_3(t)$	$F_1(\omega) - F_2(\omega) + F_3(\omega)$
$d^n f(t)/dt^n$	$(j\omega)^n F(\omega)$
$\int_{-\infty}^t f(x) dx$	$F(\omega)/j\omega$
$f(at)$	$\frac{1}{a}F\left(\frac{\omega}{a}\right), a > 0$
$f(t - a)$	$e^{-j\omega a}F(\omega)$
$e^{j\omega_0 t}f(t)$	$F(\omega - \omega_0)$
$f(t) \cos \omega_0 t$	$\frac{1}{2}F(\omega - \omega_0) + \frac{1}{2}F(\omega + \omega_0)$
$\int_{-\infty}^{\infty} x(\lambda)h(t - \lambda) d\lambda$	$X(\omega)H(\omega)$
$f_1(t)f_2(t)$	$\frac{1}{2\pi} \int_{-\infty}^{\infty} F_1(u)F_2(\omega - u) du$
$t^n f(t)$	$(j)^n \frac{d^n F(\omega)}{d\omega^n}$

## ASSESSMENT PROBLEMS

### Objective 1—Be able to calculate the Fourier transform of a function

17.4 Suppose  $f(t)$  is defined as follows:

$$f(t) = \frac{2A}{\tau}t + A, \quad -\frac{\tau}{2} \leq t \leq 0,$$

$$f(t) = -\frac{2A}{\tau}t + A, \quad 0 \leq t \leq \frac{\tau}{2},$$

$$f(t) = 0, \quad \text{elsewhere.}$$

- Find the second derivative of  $f(t)$ .
- Find the Fourier transform of the second derivative.
- Use the result obtained in (b) to find the Fourier transform of the function in (a). (*Hint:* Use the operational transform of differentiation.)

**Answer:** (a)  $\frac{d^2f}{dt^2} = \frac{2A}{\tau}\delta\left(t + \frac{\tau}{2}\right) - \frac{4A}{\tau}\delta(t) + \frac{2A}{\tau}\delta\left(t - \frac{\tau}{2}\right);$

(b)  $\frac{4A}{\tau}\left(\cos\frac{\omega\tau}{2} - 1\right);$

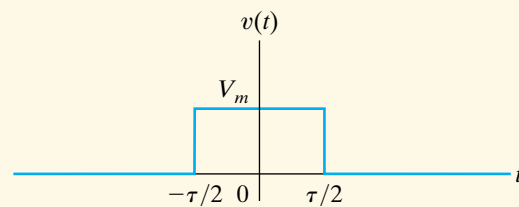
(c)  $\frac{4A}{\omega^2\tau}\left(1 - \cos\frac{\omega\tau}{2}\right).$

*NOTE:* Also try Chapter Problem 17.19.

17.5 The rectangular pulse shown can be expressed as the difference between two step voltages; that is,

$$v(t) = V_m u\left(t + \frac{\tau}{2}\right) - V_m u\left(t - \frac{\tau}{2}\right) \text{ V.}$$

Use the operational transform for translation in the time domain to find the Fourier transform of  $v(t)$ .



**Answer:**  $V(\omega) = V_m\tau \frac{\sin(\omega\tau/2)}{(\omega\tau/2)}.$

## 17.7 Circuit Applications

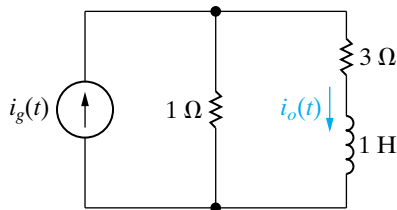
The Laplace transform is used more widely to find the response of a circuit than is the Fourier transform, for two reasons. First, the Laplace transform integral converges for a wider range of driving functions, and second, it accommodates initial conditions. Despite the advantages of the Laplace transform, we can use the Fourier transform to find the response. The fundamental relationship underlying the use of the Fourier transform in transient analysis is Eq. 17.55, which relates the transform of the response  $Y(\omega)$  to the transform of the input  $X(\omega)$  and the transfer function  $H(\omega)$  of the circuit. Note that  $H(\omega)$  is the familiar  $H(s)$  with  $s$  replaced by  $j\omega$ .

Example 17.1 illustrates how to use the Fourier transform to find the response of a circuit.



**Example 17.1** Using the Fourier Transform to Find the Transient Response

Use the Fourier transform to find  $i_o(t)$  in the circuit shown in Fig. 17.9. The current source  $i_g(t)$  is the signum function  $20 \operatorname{sgn}(t)$  A.



**Figure 17.9** ▲ The circuit for Example 17.1.

**Solution**

The Fourier transform of the driving source is

$$\begin{aligned} I_g(\omega) &= \mathcal{F}\{20 \operatorname{sgn}(t)\} \\ &= 20 \left( \frac{2}{j\omega} \right) \\ &= \frac{40}{j\omega}. \end{aligned}$$

The transfer function of the circuit is the ratio of  $I_o$  to  $I_g$ ; so

$$H(\omega) = \frac{I_o}{I_g} = \frac{1}{4 + j\omega}.$$

The Fourier transform of  $i_o(t)$  is

$$\begin{aligned} I_o(\omega) &= I_g(\omega)H(\omega) \\ &= \frac{40}{j\omega(4 + j\omega)}. \end{aligned}$$

Expanding  $I_o(\omega)$  into a sum of partial fractions yields

$$I_o(\omega) = \frac{K_1}{j\omega} + \frac{K_2}{4 + j\omega}.$$

Evaluating  $K_1$  and  $K_2$  gives

$$K_1 = \frac{40}{4} = 10,$$

$$K_2 = \frac{40}{-4} = -10.$$

Therefore

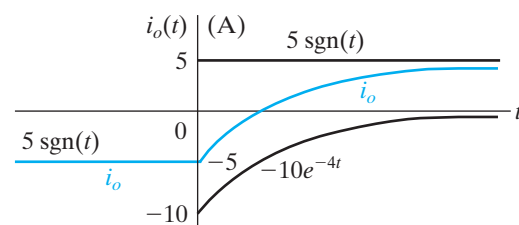
$$I_o(\omega) = \frac{10}{j\omega} - \frac{10}{4 + j\omega}.$$

The response is

$$\begin{aligned} i_o(t) &= \mathcal{F}^{-1}[I_o(\omega)] \\ &= 5 \operatorname{sgn}(t) - 10e^{-4t}u(t). \end{aligned}$$

Figure 17.10 shows the response. Does the solution make sense in terms of known circuit behavior? The answer is yes, for the following reasons. The current source delivers  $-20$  A to the circuit between  $-\infty$  and  $0$ . The resistance in each branch governs how the  $-20$  A divides between the two branches. In particular, one fourth of the  $-20$  A appears in the  $i_o$  branch; therefore  $i_o$  is  $-5$  for  $t < 0$ . When the current source jumps from  $-20$  A to  $+20$  A at  $t = 0$ ,  $i_o$  approaches its final value of  $+5$  A exponentially with a time constant of  $\frac{1}{4}$  s.

An important characteristic of the Fourier transform is that it directly yields the steady-state response to a sinusoidal driving function. The reason is that the Fourier transform of  $\cos \omega_0 t$  is based on the assumption that the function exists over all time. Example 17.2 illustrates this feature.



**Figure 17.10** ▲ The plot of  $i_o(t)$  versus  $t$ .

**Example 17.2** Using the Fourier Transform to Find the Sinusoidal Steady-State Response

The current source in the circuit in Example 17.1 (Fig. 17.9) is changed to a sinusoidal source. The expression for the current is

$$i_g(t) = 50 \cos 3t \text{ A.}$$

Use the Fourier transform method to find  $i_o(t)$ .

**Solution**

The transform of the driving function is

$$I_g(\omega) = 50\pi[\delta(\omega - 3) + \delta(\omega + 3)].$$

As before, the transfer function of the circuit is

$$H(\omega) = \frac{1}{4 + j\omega}.$$

The transform of the current response then is

$$I_o(\omega) = 50\pi \frac{\delta(\omega - 3) + \delta(\omega + 3)}{4 + j\omega}.$$

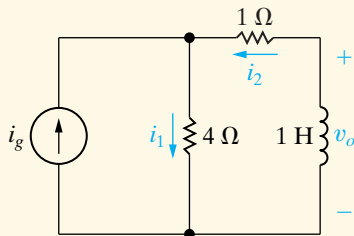
Because of the sifting property of the impulse function, the easiest way to find the inverse transform of  $I_o(\omega)$  is by the inversion integral:

$$\begin{aligned} i_o(t) &= \mathcal{F}^{-1}\{I_o(\omega)\} \\ &= \frac{50\pi}{2\pi} \int_{-\infty}^{\infty} \left[ \frac{\delta(\omega - 3) + \delta(\omega + 3)}{4 + j\omega} \right] e^{j\omega t} d\omega \\ &= 25 \left( \frac{e^{j3t}}{4 + j3} + \frac{e^{-j3t}}{4 - j3} \right) \\ &= 25 \left( \frac{e^{j3t} e^{-j36.87^\circ}}{5} + \frac{e^{-j3t} e^{j36.87^\circ}}{5} \right) \\ &= 5[2\cos(3t - 36.87^\circ)] \\ &= 10\cos(3t - 36.87^\circ). \end{aligned}$$

We leave you to verify that the solution for  $i_o(t)$  is identical to that obtained by phasor analysis.

**ASSESSMENT PROBLEMS****Objective 2—Know how to use the Fourier transform to find the response of a circuit**

- 17.6** The current source in the circuit shown delivers a current of  $10 \operatorname{sgn}(t)$  A. The response is the voltage across the 1 H inductor. Compute (a)  $I_g(\omega)$ ; (b)  $H(j\omega)$ ; (c)  $V_o(\omega)$ ; (d)  $v_o(t)$ ; (e)  $i_1(0^-)$ ; (f)  $i_1(0^+)$ ; (g)  $i_2(0^-)$ ; (h)  $i_2(0^+)$ ; (i)  $v_o(0^-)$ ; and (j)  $v_o(0^+)$ .



- Answer:** (a)  $20/j\omega$ ;  
 (b)  $4j\omega/(5 + j\omega)$ ;  
 (c)  $80/(5 + j\omega)$ ;  
 (d)  $80e^{-5t}u(t)$  V;  
 (e)  $-2$  A;  
 (f)  $18$  A;  
 (g)  $8$  A;

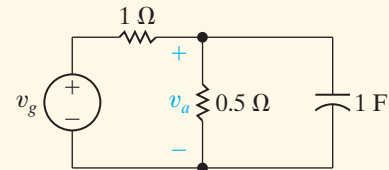
**NOTE:** Also try Chapter Problems 17.20, 17.28, and 17.30.

- (h)  $8$  A;  
 (i)  $0$  V;  
 (j)  $80$  V.

- 17.7** The voltage source in the circuit shown is generating the voltage

$$v_g = e^t u(-t) + u(t) \text{ V.}$$

- a) Use the Fourier transform method to find  $v_a$ .  
 b) Compute  $v_a(0^-)$ ,  $v_a(0^+)$ , and  $v_a(\infty)$ .



- Answer:** (a)  $v_a = \frac{1}{4} e^t u(-t) - \frac{1}{12} e^{-3t} u(t) + \frac{1}{6} + \frac{1}{6} \operatorname{sgn}(t)$  V;  
 (b)  $\frac{1}{4}$  V,  $\frac{1}{4}$  V,  $\frac{1}{3}$  V.

## 17.8 Parseval's Theorem

Parseval's theorem relates the energy associated with a time-domain function of finite energy to the Fourier transform of the function. Imagine that the time-domain function  $f(t)$  is either the voltage across or the current in a  $1 \Omega$  resistor. The energy associated with this function then is

$$W_{1\Omega} = \int_{-\infty}^{\infty} f^2(t) dt. \quad (17.57)$$

Parseval's theorem holds that this same energy can be calculated by an integration in the frequency domain, or specifically,

$$\int_{-\infty}^{\infty} f^2(t) dt = \frac{1}{2\pi} \int_{-\infty}^{\infty} |F(\omega)|^2 d\omega. \quad (17.58)$$

Therefore the  $1 \Omega$  energy associated with  $f(t)$  can be calculated either by integrating the square of  $f(t)$  over all time or by integrating  $1/2\pi$  times the square of the magnitude of the Fourier transform of  $f(t)$  over all frequencies. Parseval's theorem is valid if both integrals exist.

The average power associated with time-domain signals of finite energy is zero when averaged over all time. Therefore, when comparing signals of this type, we resort to the energy content of the signals. Using a  $1 \Omega$  resistor as the base for the energy calculation is convenient for comparing the energy content of voltage and current signals.

We begin the derivation of Eq. 17.58 by rewriting the kernel of the integral on the left-hand side as  $f(t)$  times itself and then expressing one  $f(t)$  in terms of the inversion integral:

$$\begin{aligned} \int_{-\infty}^{\infty} f^2(t) dt &= \int_{-\infty}^{\infty} f(t) f(t) dt \\ &= \int_{-\infty}^{\infty} f(t) \left[ \frac{1}{2\pi} \int_{-\infty}^{\infty} F(\omega) e^{j\omega t} d\omega \right] dt. \end{aligned} \quad (17.59)$$

We move  $f(t)$  inside the interior integral, because the integration is with respect to  $\omega$ , and then factor the constant  $1/2\pi$  outside both integrations. Thus Eq. 17.59 becomes

$$\int_{-\infty}^{\infty} f^2(t) dt = \frac{1}{2\pi} \int_{-\infty}^{\infty} \left[ \int_{-\infty}^{\infty} F(\omega) f(t) e^{j\omega t} d\omega \right] dt. \quad (17.60)$$

We reverse the order of integration and in so doing recognize that  $F(\omega)$  can be factored out of the integration with respect to  $t$ . Thus

$$\int_{-\infty}^{\infty} f^2(t) dt = \frac{1}{2\pi} \int_{-\infty}^{\infty} F(\omega) \left[ \int_{-\infty}^{\infty} f(t) e^{j\omega t} dt \right] d\omega. \quad (17.61)$$

The interior integral is  $F(-\omega)$ , so Eq. 17.61 reduces to

$$\int_{-\infty}^{\infty} f^2(t) dt = \frac{1}{2\pi} \int_{-\infty}^{\infty} F(\omega) F(-\omega) d\omega. \quad (17.62)$$

In Section 17.6, we noted that  $F(-\omega) = F^*(\omega)$ . Thus the product  $F(\omega)F(-\omega)$  is simply the magnitude of  $F(\omega)$  squared, and Eq. 17.62 is equivalent to Eq. 17.58. We also noted that  $|F(\omega)|$  is an even function of  $\omega$ . Therefore, we can also write Eq. 17.58 as

$$\int_{-\infty}^{\infty} f^2(t) dt = \frac{1}{\pi} \int_0^{\infty} |F(\omega)|^2 d\omega. \quad (17.63)$$

### A Demonstration of Parseval's Theorem

We can best demonstrate the validity of Eq. 17.63 with a specific example. If

$$f(t) = e^{-a|t|},$$

the left-hand side of Eq. 17.63 becomes

$$\begin{aligned} \int_{-\infty}^{\infty} e^{-2a|t|} dt &= \int_{-\infty}^0 e^{2at} dt + \int_0^{\infty} e^{-2at} dt \\ &= \frac{e^{2at}}{2a} \Big|_{-\infty}^0 + \frac{e^{-2at}}{-2a} \Big|_0^{\infty} \\ &= \frac{1}{2a} + \frac{1}{2a} = \frac{1}{a}. \end{aligned} \quad (17.64)$$

The Fourier transform of  $f(t)$  is

$$F(\omega) = \frac{2a}{a^2 + \omega^2},$$

and therefore the right-hand side of Eq. 17.63 becomes

$$\begin{aligned} \frac{1}{\pi} \int_0^{\infty} \frac{4a^2}{(a^2 + \omega^2)^2} d\omega &= \frac{4a^2}{\pi} \frac{1}{2a^2} \left( \frac{\omega}{\omega^2 + a^2} + \frac{1}{a} \tan^{-1} \frac{\omega}{a} \right) \Big|_0^{\infty} \\ &= \frac{2}{\pi} \left( 0 + \frac{\pi}{2a} - 0 - 0 \right) \\ &= \frac{1}{a}. \end{aligned} \quad (17.65)$$

Note that the result given by Eq. 17.65 is the same as that given by Eq. 17.64.

### The Interpretation of Parseval's Theorem

Parseval's theorem gives a physical interpretation that the magnitude of the Fourier transform squared,  $|F(\omega)|^2$ , is an energy density (in joules per hertz). To see it, we write the right-hand side of Eq. 17.63 as

$$\frac{1}{\pi} \int_0^{\infty} |F(2\pi f)|^2 2\pi df = 2 \int_0^{\infty} |F(2\pi f)|^2 df, \quad (17.66)$$

where  $|F(2\pi f)|^2 df$  is the energy in an infinitesimal band of frequencies ( $df$ ), and the total 1  $\Omega$  energy associated with  $f(t)$  is the summation (integration) of  $|F(2\pi f)|^2 df$  over all frequencies. We can associate a portion of the total energy with a specified band of frequencies. In other words, the 1  $\Omega$  energy in the frequency band from  $\omega_1$  to  $\omega_2$  is

$$W_{1\Omega} = \frac{1}{\pi} \int_{\omega_1}^{\omega_2} |F(\omega)|^2 d\omega. \tag{17.67}$$

Note that expressing the integration in the frequency domain as

$$\frac{1}{2\pi} \int_{-\infty}^{\infty} |F(\omega)|^2 d\omega$$

instead of

$$\frac{1}{\pi} \int_0^{\infty} |F(\omega)|^2 d\omega$$

allows Eq. 17.67 to be written in the form

$$W_{1\Omega} = \frac{1}{2\pi} \int_{-\omega_2}^{-\omega_1} |F(\omega)|^2 d\omega + \frac{1}{2\pi} \int_{\omega_1}^{\omega_2} |F(\omega)|^2 d\omega. \tag{17.68}$$

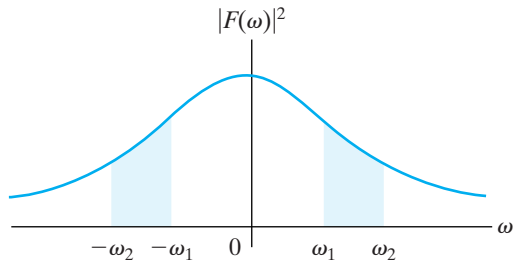


Figure 17.11 ▲ The graphic interpretation of Eq. 17.68.

Figure 17.11 shows the graphic interpretation of Eq. 17.68.

Examples 17.3–17.5 illustrate calculations involving Parseval’s theorem.

**Example 17.3** Applying Parseval’s Theorem

The current in a 40 Ω resistor is

$$i = 20e^{-2t}u(t) \text{ A.}$$

What percentage of the total energy dissipated in the resistor can be associated with the frequency band  $0 \leq \omega \leq 2\sqrt{3}$  rad/s?

**Solution**

The total energy dissipated in the 40 Ω resistor is

$$\begin{aligned} W_{40\Omega} &= 40 \int_0^{\infty} 400e^{-4t} dt \\ &= 16,000 \left. \frac{e^{-4t}}{-4} \right|_0^{\infty} = 4000 \text{ J.} \end{aligned}$$

We can check this total energy calculation with Parseval’s theorem:

$$F(\omega) = \frac{20}{2 + j\omega}.$$

Therefore

$$|F(\omega)| = \frac{20}{\sqrt{4 + \omega^2}}$$

and

$$\begin{aligned} W_{40\Omega} &= \frac{40}{\pi} \int_0^{\infty} \frac{400}{4 + \omega^2} d\omega \\ &= \frac{16,000}{\pi} \left( \frac{1}{2} \tan^{-1} \frac{\omega}{2} \right) \Big|_0^{\infty} \\ &= \frac{8000}{\pi} \left( \frac{\pi}{2} \right) = 4000 \text{ J.} \end{aligned}$$

The energy associated with the frequency band  $0 \leq \omega \leq 2\sqrt{3}$  rad/s is

$$\begin{aligned} W_{40\Omega} &= \frac{40}{\pi} \int_{\sqrt{3}}^2 \frac{400}{4 + \omega^2} d\omega \\ &= \frac{16,000}{\pi} \left( \frac{1}{2} \tan^{-1} \frac{\omega}{2} \right) \Big|_0^{2\sqrt{3}} \\ &= \frac{8000}{\pi} \left( \frac{\pi}{3} \right) = \frac{8000}{3} \text{ J.} \end{aligned}$$

Hence the percentage of the total energy associated with this range of frequencies is

$$\eta = \frac{8000/3}{4000} \times 100 = 66.67\%.$$

**Example 17.4** Applying Parseval's Theorem to an Ideal Bandpass Filter

The input voltage to an ideal bandpass filter is

$$v(t) = 120e^{-24t}u(t) \text{ V.}$$

The filter passes all frequencies that lie between 24 and 48 rad/s, without attenuation, and completely rejects all frequencies outside this passband.

- Sketch  $|V(\omega)|^2$  for the filter input voltage.
- Sketch  $|V_o(\omega)|^2$  for the filter output voltage.
- What percentage of the total  $1 \Omega$  energy content of the signal at the input of the filter is available at the output?

**Solution**

- a) The Fourier transform of the filter input voltage is

$$V(\omega) = \frac{120}{24 + j\omega}.$$

Therefore

$$|V(\omega)|^2 = \frac{14,400}{576 + \omega^2}.$$

Fig. 17.12 shows the sketch of  $|V(\omega)|^2$  versus  $\omega$ .

- b) The ideal bandpass filter rejects all frequencies outside the passband, so the plot of  $|V_o(\omega)|^2$  versus  $\omega$  appears as shown in Fig. 17.13.

- c) The total  $1 \Omega$  energy available at the input to the filter is

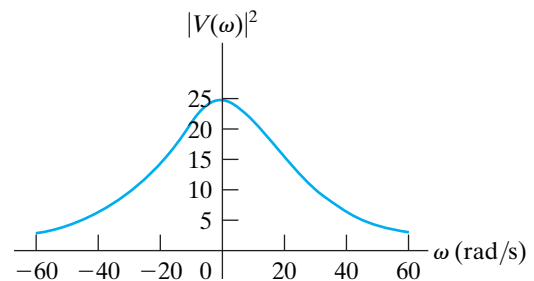
$$\begin{aligned} W_i &= \frac{1}{\pi} \int_0^{\infty} \frac{14,400}{576 + \omega^2} d\omega = \frac{14,400}{\pi} \left( \frac{1}{24} \tan^{-1} \frac{\omega}{24} \right) \Big|_0^{\infty} \\ &= \frac{600}{\pi} \frac{\pi}{2} = 300 \text{ J.} \end{aligned}$$

The total  $1 \Omega$  energy available at the output of the filter is

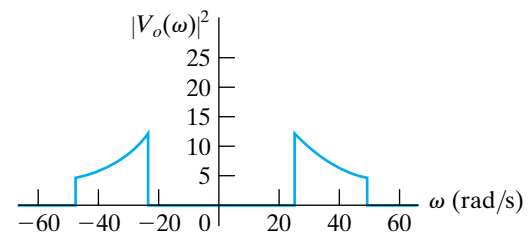
$$\begin{aligned} W_o &= \frac{1}{\pi} \int_{24}^{48} \frac{14,400}{576 + \omega^2} d\omega = \frac{600}{\pi} \tan^{-1} \frac{\omega}{24} \Big|_{24}^{48} \\ &= \frac{600}{\pi} (\tan^{-1} 2 - \tan^{-1} 1) = \frac{600}{\pi} \left( \frac{\pi}{2.84} - \frac{\pi}{4} \right) \\ &= 61.45 \text{ J.} \end{aligned}$$

The percentage of the input energy available at the output is

$$\eta = \frac{61.45}{300} \times 100 = 20.48\%.$$



**Figure 17.12**  $|V(\omega)|^2$  versus  $\omega$  for Example 17.4.



**Figure 17.13**  $|V_o(\omega)|^2$  versus  $\omega$  for Example 17.4.

**Example 17.5** Applying Parseval's Theorem to a Low-Pass Filter

Parseval's theorem makes it possible to calculate the energy available at the output of the filter even if we don't know the time-domain expression for  $v_o(t)$ . Suppose the input voltage to the low-pass  $RC$  filter circuit shown in Fig. 17.14 is

$$v_i(t) = 15e^{-5t}u(t) \text{ V.}$$

- What percentage of the 1  $\Omega$  energy available in the input signal is available in the output signal?
- What percentage of the output energy is associated with the frequency range  $0 \leq \omega \leq 10$  rad/s?

**Solution**

- The 1  $\Omega$  energy in the input signal to the filter is

$$W_i = \int_0^{\infty} (15e^{-5t})^2 dt = 225 \left. \frac{e^{-10t}}{-10} \right|_0^{\infty} = 22.5 \text{ J.}$$

The Fourier transform of the output voltage is

$$V_o(\omega) = V_i(\omega)H(\omega),$$

where

$$V_i(\omega) = \frac{15}{5 + j\omega}$$

$$H(\omega) = \frac{1/RC}{1/RC + j\omega} = \frac{10}{10 + j\omega}.$$

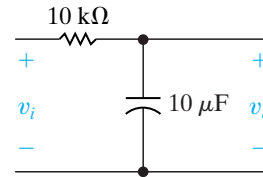
Hence

$$V_o(\omega) = \frac{150}{(5 + j\omega)(10 + j\omega)}$$

$$|V_o(\omega)|^2 = \frac{22,500}{(25 + \omega^2)(100 + \omega^2)}.$$

The 1  $\Omega$  energy available in the output signal of the filter is

$$W_o = \frac{1}{\pi} \int_0^{\infty} \frac{22,500}{(25 + \omega^2)(100 + \omega^2)} d\omega.$$



**Figure 17.14** ▲ The low-pass  $RC$  filter for Example 17.5.

We can easily evaluate the integral by expanding the kernel into a sum of partial fractions:

$$\frac{22,500}{(25 + \omega^2)(100 + \omega^2)} = \frac{300}{25 + \omega^2} - \frac{300}{100 + \omega^2}.$$

Then

$$\begin{aligned} W_o &= \frac{300}{\pi} \left\{ \int_0^{\infty} \frac{d\omega}{25 + \omega^2} - \int_0^{\infty} \frac{d\omega}{100 + \omega^2} \right\} \\ &= \frac{300}{\pi} \left[ \frac{1}{5} \left( \frac{\pi}{2} \right) - \frac{1}{10} \left( \frac{\pi}{2} \right) \right] = 15 \text{ J.} \end{aligned}$$

The energy available in the output signal therefore is 66.67% of the energy available in the input signal; that is,

$$\eta = \frac{15}{22.5}(100) = 66.67\%.$$

- The output energy associated with the frequency range  $0 \leq \omega \leq 10$  rad/s is

$$\begin{aligned} W'_o &= \frac{300}{\pi} \left\{ \int_0^{10} \frac{d\omega}{25 + \omega^2} - \int_0^{10} \frac{d\omega}{100 + \omega^2} \right\} \\ &= \frac{300}{\pi} \left( \frac{1}{5} \tan^{-1} \frac{10}{5} - \frac{1}{10} \tan^{-1} \frac{10}{10} \right) = \frac{30}{\pi} \left( \frac{2\pi}{2.84} - \frac{\pi}{4} \right) \\ &= 13.64 \text{ J.} \end{aligned}$$

The total 1  $\Omega$  energy in the output signal is 15 J, so the percentage associated with the frequency range 0 to 10 rad/s is 90.97%.

**The Energy Contained in a Rectangular Voltage Pulse**

We conclude our discussion of Parseval's theorem by calculating the energy associated with a rectangular voltage pulse. In Section 17.1 we found the Fourier transform of the voltage pulse to be

$$V(\omega) = V_m \tau \frac{\sin \omega\tau/2}{\omega\tau/2}. \quad (17.69)$$

To aid our discussion, we have redrawn the voltage pulse and its Fourier transform in Fig. 17.15(a) and (b), respectively. These figures show that, as the width of the voltage pulse ( $\tau$ ) becomes smaller, the dominant portion of the amplitude spectrum (that is, the spectrum from  $-2\pi/\tau$  to  $2\pi/\tau$ ) spreads out over a wider range of frequencies. This result agrees with our earlier comments about the operational transform involving a scale change, in other words, when time is compressed, frequency is stretched out and vice versa. To transmit a single rectangular pulse with reasonable fidelity, the bandwidth of the system must be at least wide enough to accommodate the dominant portion of the amplitude spectrum. Thus the cutoff frequency should be at least  $2\pi/\tau$  rad/s, or  $1/\tau$  Hz.

We can use Parseval's theorem to calculate the fraction of the total energy associated with  $v(t)$  that lies in the frequency range  $0 \leq \omega \leq 2\pi/\tau$ . From Eq. 17.69,

$$W = \frac{1}{\pi} \int_0^{2\pi/\tau} V_m^2 \tau^2 \frac{\sin^2 \omega\tau/2}{(\omega\tau/2)^2} d\omega. \quad (17.70)$$

To carry out the integration called for in Eq. 17.70, we let

$$x = \frac{\omega\tau}{2}, \quad (17.71)$$

noting that

$$dx = \frac{\tau}{2} d\omega \quad (17.72)$$

and that

$$x = \pi, \quad \text{when } \omega = 2\pi/\tau. \quad (17.73)$$

If we make the substitutions given by Eqs. 17.71–17.73, Eq. 17.70 becomes

$$W = \frac{2V_m^2 \tau}{\pi} \int_0^\pi \frac{\sin^2 x}{x^2} dx. \quad (17.74)$$

We can integrate the integral in Eq. 17.74 by parts. If we let

$$u = \sin^2 x \quad (17.75)$$

$$dv = \frac{dx}{x^2}, \quad (17.76)$$

then

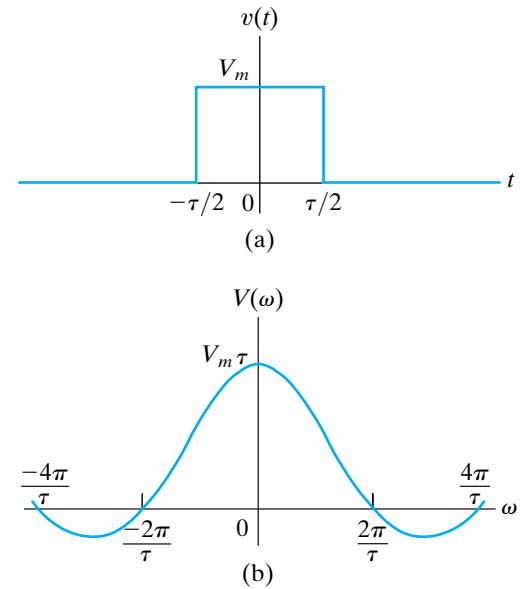
$$du = 2\sin x \cos x dx = \sin 2x dx, \quad (17.77)$$

and

$$v = -\frac{1}{x}. \quad (17.78)$$

Hence

$$\begin{aligned} \int_0^\pi \frac{\sin^2 x}{x^2} dx &= -\frac{\sin^2 x}{x} \Big|_0^\pi - \int_0^\pi -\frac{1}{x} \sin 2x dx \\ &= 0 + \int_0^\pi \frac{\sin 2x}{x} dx. \end{aligned} \quad (17.79)$$



**Figure 17.15** ▲ The rectangular voltage pulse and its Fourier transform. (a) The rectangular voltage pulse. (b) The Fourier transform of  $v(t)$ .



Substituting Eq. 17.79 into Eq. 17.74 yields

$$W = \frac{4V_m^2\tau}{\pi} \int_0^\pi \frac{\sin 2x}{2x} dx. \quad (17.80)$$

To evaluate the integral in Eq. 17.80, we must first put it in the form of  $\sin y/y$ . We do so by letting  $y = 2x$  and noting that  $dy = 2 dx$ , and  $y = 2\pi$  when  $x = \pi$ . Thus Eq. 17.80 becomes

$$W = \frac{2V_m^2\tau}{\pi} \int_0^{2\pi} \frac{\sin y}{y} dy. \quad (17.81)$$

The value of the integral in Eq. 17.81 can be found in a table of sine integrals.<sup>1</sup> Its value is 1.41815, so

$$W = \frac{2V_m^2\tau}{\pi}(1.41815). \quad (17.82)$$

The total  $1 \Omega$  energy associated with  $v(t)$  can be calculated either from the time-domain integration or the evaluation of Eq. 17.81 with the upper limit equal to infinity. In either case, the total energy is

$$W_t = V_m^2\tau. \quad (17.83)$$

The fraction of the total energy associated with the band of frequencies between 0 and  $2\pi/\tau$  is

$$\begin{aligned} \eta &= \frac{W}{W_t} \\ &= \frac{2V_m^2\tau(1.41815)}{\pi(V_m^2\tau)} \\ &= 0.9028. \end{aligned} \quad (17.84)$$

Therefore, approximately 90% of the energy associated with  $v(t)$  is contained in the dominant portion of the amplitude spectrum.

<sup>1</sup> M. Abramowitz and I. Stegun, *Handbook of Mathematical Functions* (New York: Dover, 1965), p. 244.

## ASSESSMENT PROBLEMS

### Objective 3—Understand Parseval's theorem and be able to use it

17.8 The voltage across a  $50\ \Omega$  resistor is

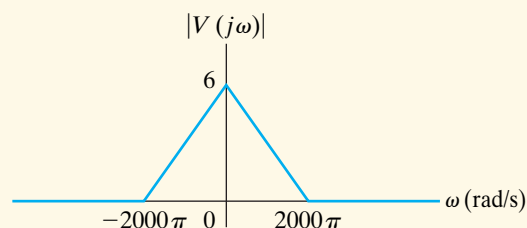
$$v = 4te^{-t}u(t)\ \text{V}.$$

What percentage of the total energy dissipated in the resistor can be associated with the frequency band  $0 \leq \omega \leq \sqrt{3}\ \text{rad/s}$ ?

**Answer:** 94.23%.

*NOTE:* Also try Chapter Problem 17.40.

17.9 Assume that the magnitude of the Fourier transform of  $v(t)$  is as shown. This voltage is applied to a  $6\ \text{k}\Omega$  resistor. Calculate the total energy delivered to the resistor.



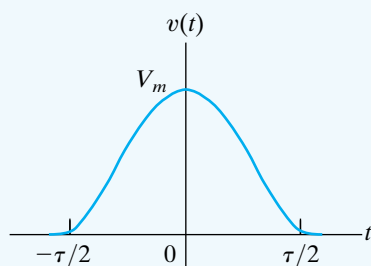
**Answer:** 4 J.

## Practical Perspective

### Filtering Digital Signals

To understand the effect of transmitting a digital signal on a telephone line, consider a simple pulse that represents a digital value of 1, using 5 V, as shown in Fig. 17.15(a), with  $V_m = 5\ \text{V}$  and  $\tau = 1\ \mu\text{s}$ . The Fourier transform of this pulse is shown in Fig. 17.15(b), where the amplitude  $V_m\tau = 5\ \mu\text{V}$  and the first positive zero-crossing on the frequency axis is  $2\pi/\tau = 6.28\ \text{Mrad/s} = 1\ \text{MHz}$ .

Note that the digital pulse representing the value 1 is ideally a sum of an infinite number of frequency components. But the telephone line cannot transmit all of these frequency components. Typically, the telephone has a bandwidth of 10 MHz, meaning that it is capable of transmitting only those frequency components below 10 MHz. This causes the original pulse to be distorted once it is received by the computer on the other end of the telephone line, as seen in Fig. 17.16.



**Figure 17.16** ▲ The effect of sending a square voltage pulse through a bandwidth-limited filter, causing distortion of the resulting output signal in the time domain.

## Summary

- The **Fourier transform** gives a frequency-domain description of an aperiodic time-domain function. Depending on the nature of the time-domain signal, one of three approaches to finding its Fourier transform may be used:
  - If the time-domain signal is a well-behaved pulse of finite duration, the integral that defines the Fourier transform is used.
  - If the one-sided Laplace transform of  $f(t)$  exists and all the poles of  $F(s)$  lie in the left half of the  $s$  plane,  $F(s)$  may be used to find  $F(\omega)$ .
  - If  $f(t)$  is a constant, a signum function, a step function, or a sinusoidal function, the Fourier transform is found by using a limit process.
 (See page 646.)
- Functional and operational Fourier transforms that are useful in circuit analysis are tabulated in Tables 17.1 and 17.2. (See pages 655 and 660.)

- The Fourier transform of a response signal  $y(t)$  is
 
$$Y(\omega) = X(\omega)H(\omega),$$

where  $X(\omega)$  is the Fourier transform of the input signal  $x(t)$ , and  $H(\omega)$  is the transfer function  $H(s)$  evaluated at  $s = j\omega$ . (See page 660.)

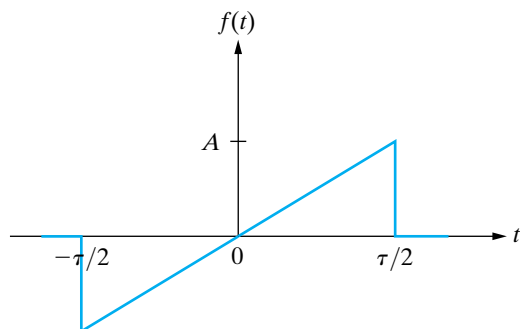
- The Fourier transform accommodates both negative-time and positive-time functions and therefore is suited to problems described in terms of events that start at  $t = -\infty$ . In contrast, the unilateral Laplace transform is suited to problems described in terms of initial conditions and events that occur for  $t > 0$ .
- The magnitude of the Fourier transform squared is a measure of the energy density (joules per hertz) in the frequency domain (Parseval's theorem). Thus the Fourier transform permits us to associate a fraction of the total energy contained in  $f(t)$  with a specified band of frequencies. (See page 664.)

## Problems

### Sections 17.1–17.2

- 17.1** a) Find the Fourier transform of the function shown in Fig. P17.1.
- b) Find  $F(\omega)$  when  $\omega = 0$ .
- c) Sketch  $|F(\omega)|$  versus  $\omega$  when  $A = 10$  and  $\tau = 0.1$ . *Hint:* Remember that  $|F(\omega)|$  is an even function of  $\omega$ .

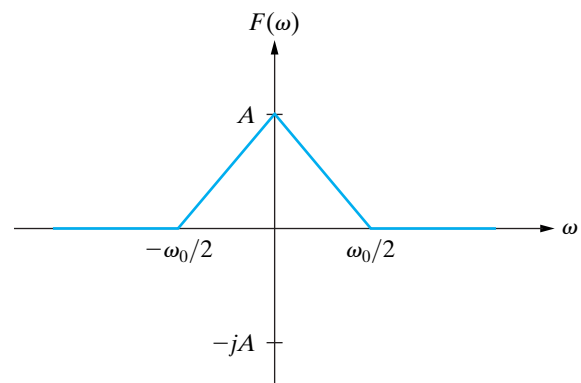
Figure P17.1



- 17.2** The Fourier transform of  $f(t)$  is shown in Fig. P17.2.

- a) Find  $f(t)$ .
- b) Evaluate  $f(0)$ .
- c) Sketch  $f(t)$  for  $-150 \leq t \leq 150$  s when  $A = 5\pi$  and  $\omega_0 = 100$  rad/s. *Hint:* Remember that  $f(t)$  is even.

Figure P17.2



**17.3** Use the defining integral to find the Fourier transform of the following functions:

$$a) f(t) = A \sin \frac{\pi}{2} t, \quad -2 \leq t \leq 2;$$

$$f(t) = 0, \quad \text{elsewhere.}$$

$$b) f(t) = \frac{2A}{\tau} t + A, \quad -\frac{\tau}{2} \leq t \leq 0;$$

$$f(t) = -\frac{2A}{\tau} t + A, \quad 0 \leq t \leq \frac{\tau}{2};$$

$$f(t) = 0, \quad \text{elsewhere.}$$

### Sections 17.3–17.5

**17.4** Derive  $\mathcal{F}\{\sin \omega_0 t\}$ .

**17.5** Find the Fourier transform of each of the following functions. In all of the functions,  $a$  is a positive real constant and  $-\infty \leq t \leq \infty$ .

$$a) f(t) = |t|e^{-a|t|};$$

$$b) f(t) = t^3 e^{-a|t|};$$

$$c) f(t) = e^{-a|t|} \cos \omega_0 t;$$

$$d) f(t) = e^{-a|t|} \sin \omega_0 t;$$

$$e) f(t) = \delta(t - t_0).$$

**17.6** If  $f(t)$  is a real function of  $t$ , show that the inversion integral reduces to

$$f(t) = \frac{1}{2\pi} \int_{-\infty}^{\infty} [A(\omega) \cos \omega t - B(\omega) \sin \omega t] d\omega.$$

**17.7** If  $f(t)$  is a real, odd function of  $t$ , show that the inversion integral reduces to

$$f(t) = -\frac{1}{2\pi} \int_{-\infty}^{\infty} B(\omega) \sin \omega t d\omega.$$

**17.8** Use the inversion integral (Eq. 17.9) to show that  $\mathcal{F}^{-1}\{2/j\omega\} = \text{sgn}(t)$ . *Hint:* Use Problem 17.7.

**17.9** Find  $\mathcal{F}\{\cos \omega_0 t\}$  by using the approximating function

$$f(t) = e^{-\epsilon|t|} \cos \omega_0 t,$$

where  $\epsilon$  is a positive real constant.

**17.10** Show that if  $f(t)$  is an odd function,

$$A(\omega) = 0,$$

$$B(\omega) = -2 \int_0^{\infty} f(t) \sin \omega t dt.$$

**17.11** Show that if  $f(t)$  is an even function,

$$A(\omega) = 2 \int_0^{\infty} f(t) \cos \omega t dt,$$

$$B(\omega) = 0.$$

### Section 17.6

**17.12** a) Show that  $\mathcal{F}\{df(t)/dt\} = j\omega F(\omega)$ , where  $F(\omega) = \mathcal{F}\{f(t)\}$ . *Hint:* Use the defining integral and integrate by parts.

b) What is the restriction on  $f(t)$  if the result given in (a) is valid?

c) Show that  $\mathcal{F}\{d^n f(t)/dt^n\} = (j\omega)^n F(\omega)$ , where  $F(\omega) = \mathcal{F}\{f(t)\}$ .

**17.13** a) Show that

$$\mathcal{F}\left\{\int_{-\infty}^t f(x) dx\right\} = \frac{F(\omega)}{j\omega},$$

where  $F(\omega) = \mathcal{F}\{f(x)\}$ . *Hint:* Use the defining integral and integrate by parts.

b) What is the restriction on  $f(x)$  if the result given in (a) is valid?

c) If  $f(x) = e^{-ax}u(x)$ , can the operational transform in (a) be used? Explain.

**17.14** a) Show that

$$\mathcal{F}\{f(at)\} = \frac{1}{a} F\left(\frac{\omega}{a}\right), \quad a > 0.$$

b) Given that  $f(at) = e^{-a|t|}$  for  $a > 0$ , sketch  $F(\omega) = \mathcal{F}\{f(at)\}$  for  $a = 0.5, 1.0$ , and  $2.0$ . Do your sketches reflect the observation that *compression* in the time domain corresponds to *stretching* in the frequency domain?

**17.15** Derive each of the following operational transforms:

$$a) \mathcal{F}\{f(t - a)\} = e^{-j\omega a} F(\omega);$$

$$b) \mathcal{F}\{e^{j\omega_0 t} f(t)\} = F(\omega - \omega_0);$$

$$c) \mathcal{F}\{f(t) \cos \omega_0 t\} = \frac{1}{2} F(\omega - \omega_0) + \frac{1}{2} F(\omega + \omega_0).$$

**17.16** Given

$$y(t) = \int_{-\infty}^{\infty} x(\lambda) h(t - \lambda) d\lambda,$$

show that  $Y(\omega) = \mathcal{F}\{y(t)\} = X(\omega)H(\omega)$ , where  $X(\omega) = \mathcal{F}\{x(t)\}$  and  $H(\omega) = \mathcal{F}\{h(t)\}$ . *Hint:* Use the defining integral to write

$$\mathcal{F}\{y(t)\} = \int_{-\infty}^{\infty} \left[ \int_{-\infty}^{\infty} x(\lambda) h(t - \lambda) d\lambda \right] e^{-j\omega t} dt.$$

Next, reverse the order of integration and then make a change in the variable of integration; that is, let  $u = t - \lambda$ .

- 17.17** Given  $f(t) = f_1(t)f_2(t)$ , show that  $F(\omega) = (1/2\pi) \int_{-\infty}^{\infty} F_1(u)F_2(\omega - u) du$ . *Hint:* First, use the defining integral to express  $F(\omega)$  as

$$F(\omega) = \int_{-\infty}^{\infty} f_1(t)f_2(t)e^{-j\omega t} dt.$$

Second, use the inversion integral to write

$$f_1(t) = \frac{1}{2\pi} \int_{-\infty}^{\infty} F_1(u)e^{ju t} du.$$

Third, substitute the expression for  $f_1(t)$  into the defining integral and then interchange the order of integration.

- 17.18** a) Show that

$$(j)^n \left[ \frac{d^n F(\omega)}{d\omega^n} \right] = \mathcal{F}\{t^n f(t)\}.$$

- b) Use the result of (a) to find each of the following Fourier transforms (assuming  $a > 0$ ):

$$\mathcal{F}\{te^{-at}u(t)\},$$

$$\mathcal{F}\{|t|e^{-a|t|}\},$$

$$\mathcal{F}\{te^{-a|t|}\}.$$

- 17.19** Suppose that  $f(t) = f_1(t)f_2(t)$ , where

$$f_1(t) = \cos \omega_0 t,$$

$$f_2(t) = 1, \quad -\tau/2 < t < \tau/2;$$

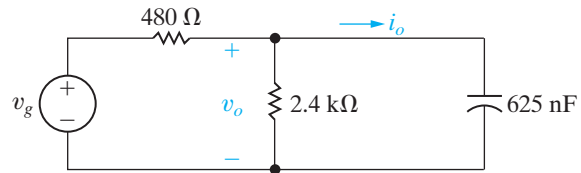
$$f_2(t) = 0, \quad \text{elsewhere.}$$

- a) Use convolution in the frequency domain to find  $F(\omega)$ .  
b) What happens to  $F(\omega)$  as the width of  $f_2(t)$  increases so that  $f(t)$  includes more and more cycles on  $f_1(t)$ ?

### Section 17.7

- 17.20** a) Use the Fourier transform method to find  $i_o(t)$  in the circuit shown in Fig. P17.20 if  $v_g = 60 \text{sgn}(t) \text{ V}$ .  
b) Does your solution make sense in terms of known circuit behavior? Explain.

**Figure P17.20**



- 17.21** Repeat Problem 17.20 except replace  $i_o(t)$  with  $v_o(t)$ .

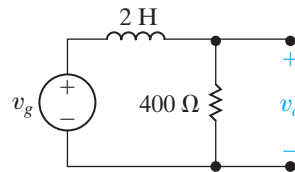
PSPICE  
MULTISIM

- 17.22** a) Use the Fourier transform method to find  $v_o(t)$  in the circuit shown in Fig. P17.22. The initial value of  $v_o(t)$  is zero, and the source voltage is  $50u(t) \text{ V}$ .

PSPICE  
MULTISIM

- b) Sketch  $v_o(t)$  versus  $t$ .

**Figure P17.22**



- 17.23** Repeat Problem 17.22 if the input voltage ( $v_g$ ) is changed to  $25 \text{sgn}(t)$ .

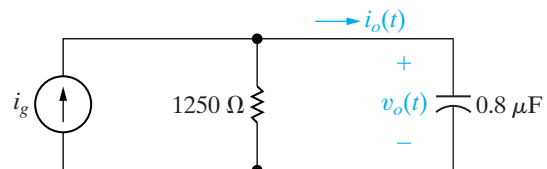
PSPICE  
MULTISIM

- 17.24** a) Use the Fourier transform to find  $i_o$  in the circuit in Fig. P17.24 if  $i_g = 40 \text{sgn}(t) \text{ mA}$ .

PSPICE  
MULTISIM

- b) Does your solution make sense in terms of known circuit behavior? Explain.

**Figure P17.24**



- 17.25** Repeat Problem 17.24 except replace  $i_o$  with  $v_o$ .

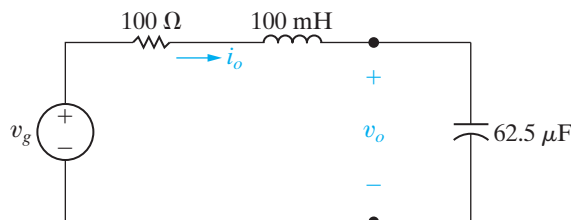
PSPICE  
MULTISIM

- 17.26** The voltage source in the circuit in Fig. P17.26 is given by the expression

$$v_g = 8 \text{sgn}(t) \text{ V}.$$

- a) Find  $v_o(t)$ .  
b) What is the value of  $v_o(0^-)$ ?  
c) What is the value of  $v_o(0^+)$ ?  
d) Use the Laplace transform method to find  $v_o(t)$  for  $t > 0^+$ .  
e) Does the solution obtained in (d) agree with  $v_o(t)$  for  $t > 0^+$  from (a)?

Figure P17.26



**17.27** Repeat Problem 17.26 except replace  $v_o(t)$  with  $i_o(t)$ .

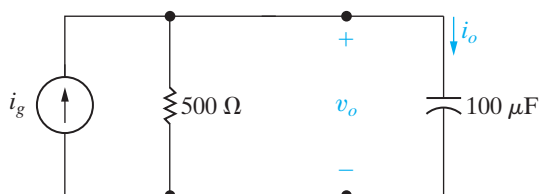
PSPICE  
MULTISIM

**17.28** a) Use the Fourier transform to find  $v_o$  in the circuit in Fig. P17.28 if  $i_g$  equals  $2e^{-100|t|}$  A.

PSPICE  
MULTISIM

- Find  $v_o(0^-)$ .
- Find  $v_o(0^+)$ .
- Use the Laplace transform method to find  $v_o$  for  $t \geq 0$ .
- Does the solution obtained in (d) agree with  $v_o$  for  $t > 0^+$  from (a)?

Figure P17.28



**17.29** a) Use the Fourier transform to find  $i_o$  in the circuit in Fig. P17.28 if  $i_g$  equals  $2e^{-100|t|}$  A.

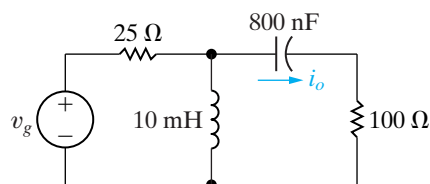
PSPICE  
MULTISIM

- Find  $i_o(0^-)$ .
- Find  $i_o(0^+)$ .
- Use the Laplace transform method to find  $i_o$  for  $t \geq 0$ .
- Does the solution obtained in (d) agree with  $i_o$  for  $t > 0^+$  from (a)?

**17.30** Use the Fourier transform method to find  $i_o$  in the circuit in Fig. P17.30 if  $v_g = 300 \cos 5000t$  V.

PSPICE  
MULTISIM

Figure P17.30

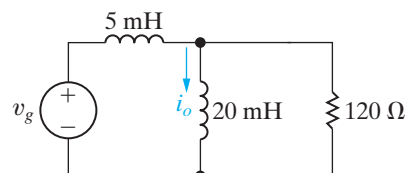


**17.31** a) Use the Fourier transform method to find  $i_o$  in the circuit in Fig. P17.31 if  $v_g = 125 \cos 40,000t$  V.

PSPICE  
MULTISIM

- Check the answer obtained in (a) by finding the steady-state expression for  $i_o$  using phasor domain analysis.

Figure P17.31



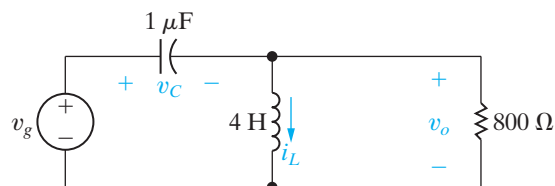
**17.32** a) Use the Fourier transform method to find  $v_o$  in the circuit shown in Fig. P17.32. The voltage source generates the voltage

PSPICE  
MULTISIM

$$v_g = 45e^{-500|t|} \text{ V.}$$

- Calculate  $v_o(0^-)$ ,  $v_o(0^+)$ , and  $v_o(\infty)$ .
- Find  $i_L(0^-)$ ;  $i_L(0^+)$ ;  $v_C(0^-)$ ; and  $v_C(0^+)$ .
- Do the results in part (b) make sense in terms of known circuit behavior? Explain.

Figure P17.32



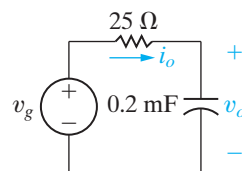
**17.33** The voltage source in the circuit in Fig. P17.33 is generating the signal

PSPICE  
MULTISIM

$$v_g = 25 \operatorname{sgn}(t) - 25 + 150e^{-100t}u(t) \text{ V.}$$

- Find  $v_o(0^-)$  and  $v_o(0^+)$ .
- Find  $i_o(0^-)$  and  $i_o(0^+)$ .
- Find  $v_o$ .

Figure P17.33



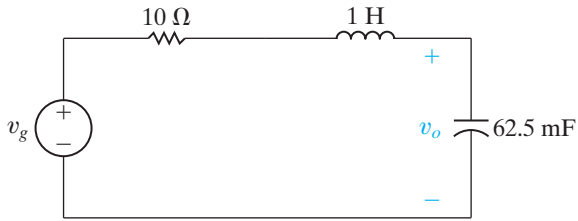
**17.34** a) Use the Fourier transform method to find  $v_o$  in the circuit in Fig. P17.34 when

PSPICE  
MULTISIM

$$v_g = 36e^{4t}u(-t) - 36e^{-4t}u(t) \text{ V.}$$

- Find  $v_o(0^-)$ .
- Find  $v_o(0^+)$ .

Figure P17.34



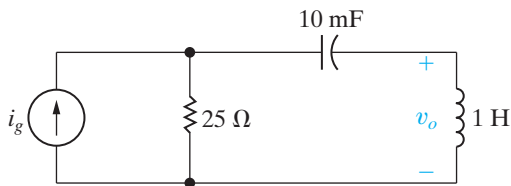
17.35 a) Use the Fourier transform method to find  $v_o$  in the circuit in Fig. P17.35 when

PSpice  
MULTISIM

$$i_g = 18e^{10t} u(-t) - 18e^{-10t} u(t) \text{ A.}$$

- b) Find  $v_o(0^-)$ .
- c) Find  $v_o(0^+)$ .
- d) Do the answers obtained in (b) and (c) make sense in terms of known circuit behavior? Explain.

Figure P17.35

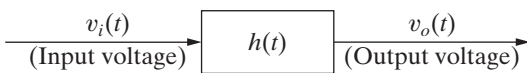


17.36 When the input voltage to the system shown in Fig. P17.36 is  $20u(t)$  V, the output voltage is

$$v_o = [40 + 60e^{-100t} - 100e^{-300t}] u(t) \text{ V.}$$

What is the output voltage if  $v_i = 20 \text{sgn}(t)$  V?

Figure P17.36



Section 17.8

17.37 It is given that  $F(\omega) = e^{\omega} u(-\omega) + e^{-\omega} u(\omega)$ .

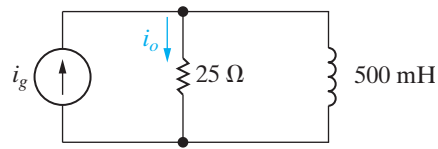
- a) Find  $f(t)$ .
- b) Find the 1  $\Omega$  energy associated with  $f(t)$  via time-domain integration.
- c) Repeat (b) using frequency-domain integration.
- d) Find the value of  $\omega_1$  if  $f(t)$  has 90% of the energy in the frequency band  $0 \leq |\omega| \leq \omega_1$ .

17.38 The circuit shown in Fig. P17.38 is driven by the current

$$i_g = 12e^{-10t} u(t) \text{ A.}$$

What percentage of the total 1  $\Omega$  energy content in the output current  $i_o$  lies in the frequency range  $0 \leq |\omega| \leq 100 \text{ rad/s}$ ?

Figure P17.38

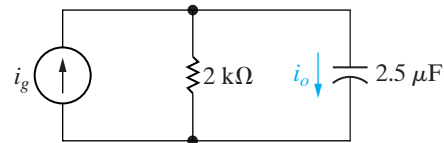


17.39 The input current signal in the circuit seen in Fig. P17.39 is

$$i_g = 10e^{-50t} u(t) \text{ mA, } t \geq 0^+.$$

What percentage of the total 1  $\Omega$  energy content in the output signal lies in the frequency range 0 to 100 rad/s?

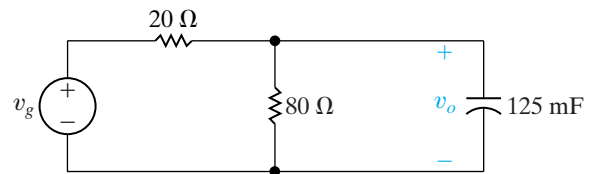
Figure P17.39



17.40 The input voltage in the circuit in Fig. P17.40 is  $v_g = 30e^{-|t|}$  V.

- a) Find  $v_o(t)$ .
- b) Sketch  $|V_g(\omega)|$  for  $-5 \leq \omega \leq 5 \text{ rad/s}$ .
- c) Sketch  $|V_o(\omega)|$  for  $-5 \leq \omega \leq 5 \text{ rad/s}$ .
- d) Calculate the 1  $\Omega$  energy content of  $v_g$ .
- e) Calculate the 1  $\Omega$  energy content of  $v_o$ .
- f) What percentage of the 1  $\Omega$  energy content in  $v_g$  lies in the frequency range  $0 \leq |\omega| \leq 2 \text{ rad/s}$ ?
- g) Repeat (f) for  $v_o$ .

Figure P17.40



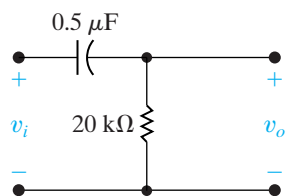
17.41 The amplitude spectrum of the input voltage to the high-pass RC filter in Fig. P17.41 is

$$V_i(\omega) = \frac{200}{|\omega|}, \quad 100 \text{ rad/s} \leq |\omega| \leq 200 \text{ rad/s};$$

$$V_i(\omega) = 0, \quad \text{elsewhere.}$$

- Sketch  $|V_i(\omega)|^2$  for  $-300 \leq \omega \leq 300$  rad/s.
- Sketch  $|V_o(\omega)|^2$  for  $-300 \leq \omega \leq 300$  rad/s.
- Calculate the  $1 \Omega$  energy in the signal at the input of the filter.
- Calculate the  $1 \Omega$  energy in the signal at the output of the filter.

Figure P17.41



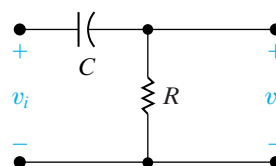
- 17.42** The input voltage to the high-pass  $RC$  filter circuit in Fig. P17.42 is

$$v_i(t) = Ae^{-at}u(t).$$

Let  $\alpha$  denote the corner frequency of the filter, that is,  $\alpha = 1/RC$ .

- What percentage of the energy in the signal at the output of the filter is associated with the frequency band  $0 \leq |\omega| \leq \alpha$  if  $\alpha = a$ ?
- Repeat (a), given that  $\alpha = \sqrt{3}a$ .
- Repeat (a), given that  $\alpha = a/\sqrt{3}$ .

Figure P17.42





# CHAPTER 18

## CHAPTER CONTENTS

- 18.1 The Terminal Equations *p.* 678
- 18.2 The Two-Port Parameters *p.* 679
- 18.3 Analysis of the Terminated Two-Port Circuit *p.* 687
- 18.4 Interconnected Two-Port Circuits *p.* 692

## ✓ CHAPTER OBJECTIVES

- 1 Be able to calculate any set of two-port parameters with any of the following methods:
  - Circuit analysis;
  - Measurements made on a circuit;
  - Converting from another set of two-port parameters using Table 18.1.
- 2 Be able to analyze a terminated two-port circuit to find currents, voltages, impedances, and ratios of interest using Table 18.2.
- 3 Know how to analyze a cascade interconnection of two-port circuits.

# Two-Port Circuits

We have frequently focused on the behavior of a circuit at a specified pair of terminals. Recall that we introduced the Thévenin and Norton equivalent circuits solely to simplify circuit analysis relative to a pair of terminals. In analyzing some electrical systems, focusing on two pairs of terminals is also convenient. In particular, this is helpful when a signal is fed into one pair of terminals and then, after being processed by the system, is extracted at a second pair of terminals. Because the terminal pairs represent the points where signals are either fed in or extracted, they are referred to as the **ports** of the system. In this chapter, we limit the discussion to circuits that have one input and one output port. Figure 18.1 on page 678 illustrates the basic two-port building block. Use of this building block is subject to several restrictions. First, there can be no energy stored within the circuit. Second, there can be no independent sources within the circuit; dependent sources, however, are permitted. Third, the current into the port must equal the current out of the port; that is,  $i_1 = i'_1$  and  $i_2 = i'_2$ . Fourth, all external connections must be made to either the input port or the output port; no such connections are allowed between ports, that is, between terminals a and c, a and d, b and c, or b and d. These restrictions simply limit the range of circuit problems to which the two-port formulation is applicable.

The fundamental principle underlying two-port modeling of a system is that only the terminal variables ( $i_1$ ,  $v_1$ ,  $i_2$ , and  $v_2$ ) are of interest. We have no interest in calculating the currents and voltages inside the circuit. We have already stressed terminal behavior in the analysis of operational amplifier circuits. In this chapter, we formalize that approach by introducing the two-port parameters.

## Practical Perspective

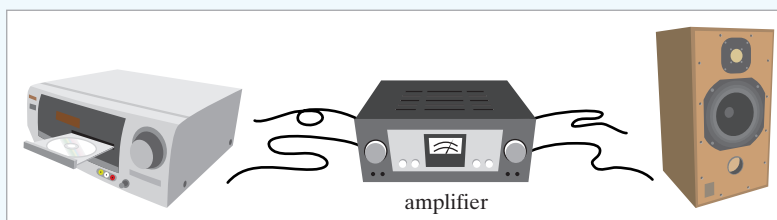
### Characterizing an Unknown Circuit

Up to this point, whenever we wanted to create a model of a circuit, we needed to know what types of components make up the circuit, the values of those components, and the interconnections among those components. But what if we want to model a circuit that is inside a "black box", where the components, their values, and their interconnections are hidden?

In this chapter, we will discover that we can perform two simple experiments on such a black box to create a model that consists of just 4 values – the two-port parameter model for the circuit. We can then use the two-port parameter

model to predict the behavior of the circuit once we have attached a power source to one of its ports and a load to the other port.

In this example, suppose we have found a circuit, enclosed in a casing, with two wires extending from each side, as shown below. The casing is labeled "amplifier" and we want to determine whether or not it would be safe to use this amplifier to connect a music player modeled as a 2 V source to a speaker modeled as a  $32\ \Omega$  resistor with a power rating of 100 W.



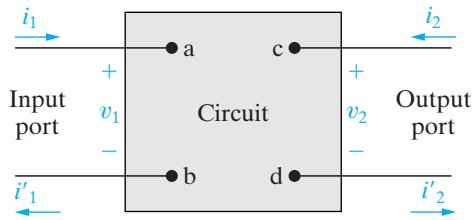


Figure 18.1 ▲ The two-port building block.

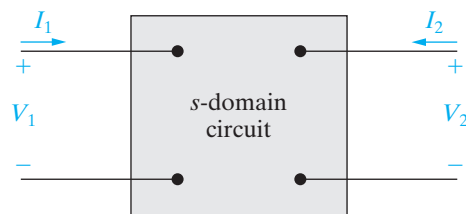


Figure 18.2 ▲ The  $s$ -domain two-port basic building block.

## 18.1 The Terminal Equations

In viewing a circuit as a two-port network, we are interested in relating the current and voltage at one port to the current and voltage at the other port. Figure 18.1 shows the reference polarities of the terminal voltages and the reference directions of the terminal currents. The references at each port are symmetric with respect to each other; that is, at each port the current is directed into the upper terminal, and each port voltage is a rise from the lower to the upper terminal. This symmetry makes it easier to generalize the analysis of a two-port network and is the reason for its universal use in the literature.

The most general description of the two-port network is carried out in the  $s$  domain. For purely resistive networks, the analysis reduces to solving resistive circuits. Sinusoidal steady-state problems can be solved either by first finding the appropriate  $s$ -domain expressions and then replacing  $s$  with  $j\omega$ , or by direct analysis in the frequency domain. Here, we write all equations in the  $s$  domain; resistive networks and sinusoidal steady-state solutions become special cases. Figure 18.2 shows the basic building block in terms of the  $s$ -domain variables  $I_1$ ,  $V_1$ ,  $I_2$ , and  $V_2$ .

Of these four terminal variables, only two are independent. Thus for any circuit, once we specify two of the variables, we can find the two remaining unknowns. For example, knowing  $V_1$  and  $V_2$  and the circuit within the box, we can determine  $I_1$  and  $I_2$ . Thus we can describe a two-port network with just two simultaneous equations. However, there are six different ways in which to combine the four variables:

$$\begin{aligned} V_1 &= z_{11}I_1 + z_{12}I_2, \\ V_2 &= z_{21}I_1 + z_{22}I_2; \end{aligned} \quad (18.1)$$

$$\begin{aligned} I_1 &= y_{11}V_1 + y_{12}V_2, \\ I_2 &= y_{21}V_1 + y_{22}V_2; \end{aligned} \quad (18.2)$$

$$\begin{aligned} V_1 &= a_{11}V_2 - a_{12}I_2, \\ I_1 &= a_{21}V_2 - a_{22}I_2; \end{aligned} \quad (18.3)$$

$$\begin{aligned} V_2 &= b_{11}V_1 - b_{12}I_1, \\ I_2 &= b_{21}V_1 - b_{22}I_1; \end{aligned} \quad (18.4)$$

$$\begin{aligned} V_1 &= h_{11}I_1 + h_{12}V_2, \\ I_2 &= h_{21}I_1 + h_{22}V_2; \end{aligned} \quad (18.5)$$

$$\begin{aligned} I_1 &= g_{11}V_1 + g_{12}I_2, \\ V_2 &= g_{21}V_1 + g_{22}I_2. \end{aligned} \quad (18.6)$$

These six sets of equations may also be considered as three pairs of mutually inverse relations. The first set, Eqs. 18.1, gives the input and output voltages as functions of the input and output currents. The second set, Eqs. 18.2, gives the inverse relationship, that is, the input and output currents as functions of the input and output voltages. Equations 18.3 and 18.4 are inverse relations, as are Eqs. 18.5 and 18.6.

The coefficients of the current and/or voltage variables on the right-hand side of Eqs. 18.1–18.6 are called the **parameters** of the two-port circuit. Thus, when using Eqs. 18.1, we refer to the  $z$  parameters of the circuit. Similarly, we refer to the  $y$  parameters, the  $a$  parameters, the  $b$  parameters, the  $h$  parameters, and the  $g$  parameters of the network.

## 18.2 The Two-Port Parameters

We can determine the parameters for any circuit by computation or measurement. The computation or measurement to be made comes directly from the parameter equations. For example, suppose that the problem is to find the  $z$  parameters for a circuit. From Eqs. 18.1,

$$z_{11} = \left. \frac{V_1}{I_1} \right|_{I_2=0} \Omega, \quad (18.7)$$

$$z_{12} = \left. \frac{V_1}{I_2} \right|_{I_1=0} \Omega, \quad (18.8)$$

$$z_{21} = \left. \frac{V_2}{I_1} \right|_{I_2=0} \Omega, \quad (18.9)$$

$$z_{22} = \left. \frac{V_2}{I_2} \right|_{I_1=0} \Omega. \quad (18.10)$$

Equations 18.7–18.10 reveal that the four  $z$  parameters can be described as follows:

- $z_{11}$  is the impedance seen looking into port 1 when port 2 is open.
- $z_{12}$  is a transfer impedance. It is the ratio of the port 1 voltage to the port 2 current when port 1 is open.
- $z_{21}$  is a transfer impedance. It is the ratio of the port 2 voltage to the port 1 current when port 2 is open.
- $z_{22}$  is the impedance seen looking into port 2 when port 1 is open.

Therefore the impedance parameters may be either calculated or measured by first opening port 2 and determining the ratios  $V_1/I_1$  and  $V_2/I_1$ , and then opening port 1 and determining the ratios  $V_1/I_2$  and  $V_2/I_2$ . Example 18.1 illustrates the determination of the  $z$  parameters for a resistive circuit.

### Example 18.1 Finding the $z$ Parameters of a Two-Port Circuit

Find the  $z$  parameters for the circuit shown in Fig. 18.3.

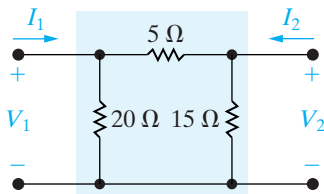


Figure 18.3 ▲ The circuit for Example 18.1.

#### Solution

The circuit is purely resistive, so the  $s$ -domain circuit is also purely resistive. With port 2 open, that is,  $I_2 = 0$ , the resistance seen looking into port 1 is the  $20 \Omega$  resistor in parallel with the series combination of the  $5$  and  $15 \Omega$  resistors. Therefore

$$z_{11} = \left. \frac{V_1}{I_1} \right|_{I_2=0} = \frac{(20)(20)}{40} = 10 \Omega.$$

When  $I_2$  is zero,  $V_2$  is

$$V_2 = \frac{V_1}{15 + 5}(15) = 0.75V_1,$$

and therefore

$$z_{21} = \left. \frac{V_2}{I_1} \right|_{I_2=0} = \frac{0.75V_1}{V_1/10} = 7.5 \Omega.$$

When  $I_1$  is zero, the resistance seen looking into port 2 is the  $15 \Omega$  resistor in parallel with the series combination of the  $5$  and  $20 \Omega$  resistors. Therefore

$$z_{22} = \left. \frac{V_2}{I_2} \right|_{I_1=0} = \frac{(15)(25)}{40} = 9.375 \Omega.$$

When port 1 is open,  $I_1$  is zero and the voltage  $V_1$  is

$$V_1 = \frac{V_2}{5 + 20}(20) = 0.8V_2.$$

With port 1 open, the current into port 2 is

$$I_2 = \frac{V_2}{9.375}.$$

Hence

$$z_{12} = \left. \frac{V_1}{I_2} \right|_{I_1=0} = \frac{0.8V_2}{V_2/9.375} = 7.5 \Omega.$$

Equations 18.7–18.10 and Example 18.1 show why the parameters in Eqs. 18.1 are called the  $z$  parameters. Each parameter is the ratio of a voltage to a current and therefore is an impedance with the dimension of ohms.

We use the same process to determine the remaining port parameters, which are either calculated or measured. A port parameter is obtained by either opening or shorting a port. Moreover, a port parameter is an impedance, an admittance, or a dimensionless ratio. The dimensionless ratio is the ratio of either two voltages or two currents. Equations 18.11–18.15 summarize these observations.

$$\begin{aligned} y_{11} &= \left. \frac{I_1}{V_1} \right|_{V_2=0} \text{ S}, & y_{12} &= \left. \frac{I_1}{V_2} \right|_{V_1=0} \text{ S}, \\ y_{21} &= \left. \frac{I_2}{V_1} \right|_{V_2=0} \text{ S}, & y_{22} &= \left. \frac{I_2}{V_2} \right|_{V_1=0} \text{ S}. \end{aligned} \quad (18.11)$$

$$\begin{aligned} a_{11} &= \left. \frac{V_1}{V_2} \right|_{I_2=0}, & a_{12} &= \left. -\frac{V_1}{I_2} \right|_{V_2=0} \Omega, \\ a_{21} &= \left. \frac{I_1}{V_2} \right|_{I_2=0} \text{ S}, & a_{22} &= \left. -\frac{I_1}{I_2} \right|_{V_2=0}. \end{aligned} \quad (18.12)$$

$$\begin{aligned} b_{11} &= \left. \frac{V_2}{V_1} \right|_{I_1=0}, & b_{12} &= \left. -\frac{V_2}{I_1} \right|_{V_1=0} \Omega, \\ b_{21} &= \left. \frac{I_2}{V_1} \right|_{I_1=0} \text{ S}, & b_{22} &= \left. -\frac{I_2}{I_1} \right|_{V_1=0}. \end{aligned} \quad (18.13)$$

$$\begin{aligned} h_{11} &= \left. \frac{V_1}{I_1} \right|_{V_2=0} \Omega, & h_{12} &= \left. \frac{V_1}{V_2} \right|_{I_1=0}, \\ h_{21} &= \left. \frac{I_2}{I_1} \right|_{V_2=0}, & h_{22} &= \left. \frac{I_2}{V_2} \right|_{I_1=0} \text{ S}. \end{aligned} \quad (18.14)$$

$$\begin{aligned} g_{11} &= \left. \frac{I_1}{V_1} \right|_{I_2=0} \text{ S}, & g_{12} &= \left. \frac{I_1}{I_2} \right|_{V_1=0}, \\ g_{21} &= \left. \frac{V_2}{V_1} \right|_{I_2=0}, & g_{22} &= \left. \frac{V_2}{I_2} \right|_{V_1=0} \Omega. \end{aligned} \quad (18.15)$$

The two-port parameters are also described in relation to the reciprocal sets of equations. The impedance and admittance parameters are grouped into the immittance parameters. The term **immittance** denotes a quantity

that is either an impedance or an admittance. The  $a$  and  $b$  parameters are called the **transmission** parameters because they describe the voltage and current at one end of the two-port network in terms of the voltage and current at the other end. The immittance and transmission parameters are the natural choices for relating the port variables. In other words, they relate either voltage to current variables or input to output variables. The  $h$  and  $g$  parameters relate cross-variables, that is, an input voltage and output current to an output voltage and input current. Therefore the  $h$  and  $g$  parameters are called **hybrid** parameters.

Example 18.2 illustrates how a set of measurements made at the terminals of a two-port circuit can be used to calculate the  $a$  parameters.

### Example 18.2 Finding the $a$ Parameters from Measurements

The following measurements pertain to a two-port circuit operating in the sinusoidal steady state. With port 2 open, a voltage equal to  $150 \cos 4000t$  V is applied to port 1. The current into port 1 is  $25 \cos(4000t - 45^\circ)$  A, and the port 2 voltage is  $100 \cos(4000t + 15^\circ)$  V. With port 2 short-circuited, a voltage equal to  $30 \cos 4000t$  V is applied to port 1. The current into port 1 is  $1.5 \cos(4000t + 30^\circ)$  A, and the current into port 2 is  $0.25 \cos(4000t + 150^\circ)$  A. Find the  $a$  parameters that can describe the sinusoidal steady-state behavior of the circuit.

#### Solution

The first set of measurements gives

$$\mathbf{V}_1 = 150 \angle 0^\circ \text{ V}, \quad \mathbf{I}_1 = 25 \angle -45^\circ \text{ A},$$

$$\mathbf{V}_2 = 100 \angle 15^\circ \text{ V}, \quad \mathbf{I}_2 = 0 \text{ A}.$$

From Eqs. 18.12,

$$a_{11} = \left. \frac{\mathbf{V}_1}{\mathbf{V}_2} \right|_{I_2=0} = \frac{150 \angle 0^\circ}{100 \angle 15^\circ} = 1.5 \angle -15^\circ,$$

$$a_{21} = \left. \frac{\mathbf{I}_1}{\mathbf{V}_2} \right|_{I_2=0} = \frac{25 \angle -45^\circ}{100 \angle 15^\circ} = 0.25 \angle -60^\circ \text{ S}.$$

The second set of measurements gives

$$\mathbf{V}_1 = 30 \angle 0^\circ \text{ V}, \quad \mathbf{I}_1 = 1.5 \angle 30^\circ \text{ A},$$

$$\mathbf{V}_2 = 0 \text{ V}, \quad \mathbf{I}_2 = 0.25 \angle 150^\circ \text{ A}.$$

Therefore

$$a_{12} = -\left. \frac{\mathbf{V}_1}{\mathbf{I}_2} \right|_{V_2=0} = \frac{-30 \angle 0^\circ}{0.25 \angle 150^\circ} = 120 \angle 30^\circ \Omega,$$

$$a_{21} = -\left. \frac{\mathbf{I}_1}{\mathbf{I}_2} \right|_{V_2=0} = \frac{-1.5 \angle 30^\circ}{0.25 \angle 150^\circ} = 6 \angle 60^\circ.$$

## ASSESSMENT PROBLEMS

**Objective 1**—Be able to calculate any set of two-port parameters

**18.1** Find the  $y$  parameters for the circuit in Fig. 18.3.

**Answer:**  $y_{11} = 0.25 \text{ S},$   
 $y_{12} = y_{21} = -0.2 \text{ S},$   
 $y_{22} = \frac{4}{15} \text{ S}.$

**18.2** Find the  $g$  and  $h$  parameters for the circuit in Fig. 18.3.

**Answer:**  $g_{11} = 0.1 \text{ S}; g_{12} = -0.75; g_{21} = 0.75;$   
 $g_{22} = 3.75 \Omega; h_{11} = 4 \Omega; h_{12} = 0.8;$   
 $h_{21} = -0.8; h_{22} = 0.1067 \text{ S}.$

**18.3** The following measurements were made on a two-port resistive circuit. With 50 mV applied to port 1 and port 2 open, the current into port 1 is  $5 \mu\text{A}$ , and the voltage across port 2 is 200 mV. With port 1 short-circuited and 10 mV applied to port 2, the current into port 1 is  $2 \mu\text{A}$ , and the current into port 2 is  $0.5 \mu\text{A}$ . Find the  $g$  parameters of the network.

**Answer:**  $g_{11} = 0.1 \text{ mS};$   
 $g_{12} = 4;$   
 $g_{21} = 4;$   
 $g_{22} = 20 \text{ k}\Omega.$

*NOTE: Also try Chapter Problems 18.2, 18.4, and 18.10.*

## Relationships Among the Two-Port Parameters

Because the six sets of equations relate to the same variables, the parameters associated with any pair of equations must be related to the parameters of all the other pairs. In other words, if we know one set of parameters, we can derive all the other sets from the known set. Because of the amount of algebra involved in these derivations, we merely list the results in Table 18.1.

**TABLE 18.1** Parameter Conversion Table

$z_{11} = \frac{y_{22}}{\Delta y} = \frac{a_{11}}{a_{21}} = \frac{b_{22}}{b_{21}} = \frac{\Delta h}{h_{22}} = \frac{1}{g_{11}}$	$b_{21} = \frac{1}{z_{12}} = -\frac{\Delta y}{y_{12}} = \frac{a_{21}}{\Delta a} = \frac{h_{22}}{h_{12}} = -\frac{g_{11}}{g_{12}}$
$z_{12} = -\frac{y_{12}}{\Delta y} = \frac{\Delta a}{a_{21}} = \frac{1}{b_{21}} = \frac{h_{12}}{h_{22}} = -\frac{g_{12}}{g_{11}}$	$b_{22} = \frac{z_{11}}{z_{12}} = \frac{y_{22}}{y_{12}} = \frac{a_{11}}{\Delta a} = \frac{\Delta h}{h_{12}} = -\frac{1}{g_{12}}$
$z_{21} = \frac{-y_{21}}{\Delta y} = \frac{1}{a_{21}} = \frac{\Delta b}{b_{21}} = -\frac{h_{21}}{h_{22}} = \frac{g_{21}}{g_{11}}$	$h_{11} = \frac{\Delta z}{z_{22}} = \frac{1}{y_{11}} = \frac{a_{12}}{a_{22}} = \frac{b_{12}}{b_{11}} = \frac{g_{22}}{\Delta g}$
$z_{22} = \frac{y_{11}}{\Delta y} = \frac{a_{22}}{a_{21}} = \frac{b_{11}}{b_{21}} = \frac{1}{h_{22}} = \frac{\Delta g}{g_{11}}$	$h_{12} = \frac{z_{12}}{z_{22}} = -\frac{y_{12}}{y_{11}} = \frac{\Delta a}{a_{22}} = \frac{1}{b_{11}} = -\frac{g_{12}}{\Delta g}$
$y_{11} = \frac{z_{22}}{\Delta z} = \frac{a_{22}}{a_{12}} = \frac{b_{11}}{b_{12}} = \frac{1}{h_{11}} = \frac{\Delta g}{g_{22}}$	$h_{21} = -\frac{z_{21}}{z_{22}} = \frac{y_{21}}{y_{11}} = -\frac{1}{a_{22}} = -\frac{\Delta b}{b_{11}} = -\frac{g_{21}}{\Delta g}$
$y_{12} = -\frac{z_{12}}{\Delta z} = -\frac{\Delta a}{a_{12}} = -\frac{1}{b_{12}} = -\frac{h_{12}}{h_{11}} = \frac{g_{12}}{g_{22}}$	$h_{22} = \frac{1}{z_{22}} = \frac{\Delta y}{y_{11}} = \frac{a_{21}}{a_{22}} = \frac{b_{21}}{b_{11}} = \frac{g_{11}}{\Delta g}$
$y_{21} = -\frac{z_{21}}{\Delta z} = -\frac{1}{a_{12}} = -\frac{\Delta b}{b_{12}} = \frac{h_{21}}{h_{11}} = -\frac{g_{21}}{g_{22}}$	$g_{11} = \frac{1}{z_{11}} = \frac{\Delta y}{y_{22}} = \frac{a_{21}}{a_{11}} = \frac{b_{21}}{b_{22}} = \frac{h_{22}}{\Delta h}$
$y_{22} = \frac{z_{11}}{\Delta z} = \frac{a_{11}}{a_{12}} = \frac{b_{22}}{b_{12}} = \frac{\Delta h}{h_{11}} = \frac{1}{g_{22}}$	$g_{12} = \frac{z_{12}}{z_{11}} = \frac{y_{12}}{y_{22}} = -\frac{\Delta a}{a_{11}} = -\frac{1}{b_{22}} = -\frac{h_{12}}{\Delta h}$
$a_{11} = \frac{z_{11}}{z_{21}} = -\frac{y_{22}}{y_{21}} = \frac{b_{22}}{\Delta b} = -\frac{h_{12}}{h_{21}} = \frac{1}{g_{21}}$	$g_{21} = \frac{z_{21}}{z_{11}} = -\frac{y_{21}}{y_{22}} = \frac{1}{a_{11}} = \frac{\Delta b}{b_{22}} = -\frac{h_{21}}{\Delta h}$
$a_{12} = \frac{\Delta z}{z_{21}} = -\frac{1}{y_{21}} = \frac{b_{12}}{\Delta b} = -\frac{h_{11}}{h_{21}} = \frac{g_{22}}{g_{21}}$	$g_{22} = \frac{\Delta z}{z_{11}} = \frac{1}{y_{22}} = \frac{a_{12}}{a_{11}} = \frac{b_{12}}{b_{22}} = \frac{h_{11}}{\Delta h}$
$a_{21} = \frac{1}{z_{21}} = -\frac{\Delta y}{y_{21}} = \frac{b_{21}}{\Delta b} = -\frac{h_{22}}{h_{21}} = \frac{g_{11}}{g_{21}}$	$\Delta z = z_{11}z_{22} - z_{12}z_{21}$
$a_{22} = \frac{z_{22}}{z_{21}} = -\frac{y_{11}}{y_{21}} = \frac{b_{11}}{\Delta b} = -\frac{1}{h_{21}} = \frac{\Delta g}{g_{21}}$	$\Delta y = y_{11}y_{22} - y_{12}y_{21}$
$b_{11} = \frac{z_{22}}{z_{12}} = -\frac{y_{11}}{y_{12}} = \frac{a_{22}}{\Delta a} = \frac{1}{h_{12}} = -\frac{\Delta g}{g_{12}}$	$\Delta a = a_{11}a_{22} - a_{12}a_{21}$
$b_{12} = \frac{\Delta z}{z_{12}} = -\frac{1}{y_{12}} = \frac{a_{12}}{\Delta a} = \frac{h_{11}}{h_{12}} = -\frac{g_{22}}{g_{12}}$	$\Delta b = b_{11}b_{22} - b_{12}b_{21}$
	$\Delta h = h_{11}h_{22} - h_{12}h_{21}$
	$\Delta g = g_{11}g_{22} - g_{12}g_{21}$

Although we do not derive all the relationships listed in Table 18.1, we do derive those between the  $z$  and  $y$  parameters and between the  $z$  and  $a$  parameters. These derivations illustrate the general process involved in relating one set of parameters to another. To find the  $z$  parameters as functions of the  $y$  parameters, we first solve Eqs. 18.2 for  $V_1$  and  $V_2$ . We

then compare the coefficients of  $I_1$  and  $I_2$  in the resulting expressions to the coefficients of  $I_1$  and  $I_2$  in Eqs. 18.1. From Eqs. 18.2,

$$V_1 = \frac{\begin{vmatrix} I_1 & y_{12} \\ I_2 & y_{22} \end{vmatrix}}{\begin{vmatrix} y_{11} & y_{12} \\ y_{21} & y_{22} \end{vmatrix}} = \frac{y_{22}}{\Delta y} I_1 - \frac{y_{12}}{\Delta y} I_2, \quad (18.16)$$

$$V_2 = \frac{\begin{vmatrix} y_{11} & I_1 \\ y_{21} & I_2 \end{vmatrix}}{\Delta y} = -\frac{y_{21}}{\Delta y} I_1 + \frac{y_{11}}{\Delta y} I_2. \quad (18.17)$$

Comparing Eqs. 18.16 and 18.17 with Eqs. 18.1 shows

$$z_{11} = \frac{y_{22}}{\Delta y}, \quad (18.18)$$

$$z_{12} = -\frac{y_{12}}{\Delta y}, \quad (18.19)$$

$$z_{21} = -\frac{y_{21}}{\Delta y}, \quad (18.20)$$

$$z_{22} = \frac{y_{11}}{\Delta y}. \quad (18.21)$$

To find the  $z$  parameters as functions of the  $a$  parameters, we rearrange Eqs. 18.3 in the form of Eqs. 18.1 and then compare coefficients. From the second equation in Eqs. 18.3,

$$V_2 = \frac{1}{a_{21}} I_1 + \frac{a_{22}}{a_{21}} I_2. \quad (18.22)$$

Therefore, substituting Eq. 18.22 into the first equation of Eqs. 18.3 yields

$$V_1 = \frac{a_{11}}{a_{21}} I_1 + \left( \frac{a_{11}a_{22}}{a_{21}} - a_{12} \right) I_2. \quad (18.23)$$

From Eq. 18.23,

$$z_{11} = \frac{a_{11}}{a_{21}}, \quad (18.24)$$

$$z_{12} = \frac{\Delta a}{a_{21}}. \quad (18.25)$$

From Eq. 18.22,

$$z_{21} = \frac{1}{a_{21}}, \quad (18.26)$$

$$z_{22} = \frac{a_{22}}{a_{21}}. \quad (18.27)$$

Example 18.3 illustrates the usefulness of the parameter conversion table.



**Example 18.3** Finding  $h$  Parameters from Measurements and Table 18.1

Two sets of measurements are made on a two-port resistive circuit. The first set is made with port 2 open, and the second set is made with port 2 short-circuited. The results are as follows:

**Port 2 Open**

$$\begin{aligned} V_1 &= 10 \text{ mV} \\ I_1 &= 10 \mu\text{A} \\ V_2 &= -40 \text{ V} \end{aligned}$$

**Port 2 Short-Circuited**

$$\begin{aligned} V_1 &= 24 \text{ mV} \\ I_1 &= 20 \mu\text{A} \\ I_2 &= 1 \text{ mA} \end{aligned}$$

Find the  $h$  parameters of the circuit.

**Solution**

We can find  $h_{11}$  and  $h_{21}$  directly from the short-circuit test:

$$\begin{aligned} h_{11} &= \left. \frac{V_1}{I_1} \right|_{V_2=0} \\ &= \frac{24 \times 10^{-3}}{20 \times 10^{-6}} = 1.2 \text{ k}\Omega, \end{aligned}$$

$$\begin{aligned} h_{21} &= \left. \frac{I_2}{I_1} \right|_{V_2=0} \\ &= \frac{10^{-3}}{20 \times 10^{-6}} = 50. \end{aligned}$$

The parameters  $h_{12}$  and  $h_{22}$  cannot be obtained directly from the open-circuit test. However, a check of Eqs. 18.7–18.15 indicates that the four  $a$  parameters can be derived from the test data. Therefore,  $h_{12}$  and  $h_{22}$  can be obtained through the conversion table. Specifically,

$$\begin{aligned} h_{12} &= \frac{\Delta a}{a_{22}} \\ h_{22} &= \frac{a_{21}}{a_{22}}. \end{aligned}$$

The  $a$  parameters are

$$a_{11} = \left. \frac{V_1}{V_2} \right|_{I_2=0} = \frac{10 \times 10^{-3}}{-40} = -0.25 \times 10^{-3},$$

$$a_{21} = \left. \frac{I_1}{V_2} \right|_{I_2=0} = \frac{10 \times 10^{-6}}{-40} = -0.25 \times 10^{-6} \text{ S},$$

$$a_{12} = -\left. \frac{V_1}{I_2} \right|_{V_2=0} = -\frac{24 \times 10^{-3}}{10^{-3}} = -24 \Omega,$$

$$a_{22} = -\left. \frac{I_1}{I_2} \right|_{V_2=0} = -\frac{20 \times 10^{-6}}{10^{-3}} = -20 \times 10^{-3}.$$

The numerical value of  $\Delta a$  is

$$\begin{aligned} \Delta a &= a_{11}a_{22} - a_{12}a_{21} \\ &= 5 \times 10^{-6} - 6 \times 10^{-6} = -10^{-6}. \end{aligned}$$

Thus

$$\begin{aligned} h_{12} &= \frac{\Delta a}{a_{22}} \\ &= \frac{-10^{-6}}{-20 \times 10^{-3}} = 5 \times 10^{-5}, \end{aligned}$$

$$\begin{aligned} h_{22} &= \frac{a_{21}}{a_{22}} \\ &= \frac{-0.25 \times 10^{-6}}{-20 \times 10^{-3}} = 12.5 \mu\text{S}. \end{aligned}$$

**ASSESSMENT PROBLEM**

**Objective 1**—Be able to calculate any set of two-port parameters

**18.4** The following measurements were made on a two-port resistive circuit: With port 1 open,  $V_2 = 15 \text{ V}$ ,  $V_1 = 10 \text{ V}$ , and  $I_2 = 30 \text{ A}$ ; with port 1 short-circuited,  $V_2 = 10 \text{ V}$ ,  $I_2 = 4 \text{ A}$ , and  $I_1 = -5 \text{ A}$ . Calculate the  $z$  parameters.

**Answer:**  $z_{11} = (4/15) \Omega$ ;  
 $z_{12} = (1/3) \Omega$ ;  
 $z_{21} = -1.6 \Omega$ ;  
 $z_{22} = 0.5 \Omega$ .

*NOTE:* Also try Chapter Problem 18.13.

## Reciprocal Two-Port Circuits

If a two-port circuit is **reciprocal**, the following relationships exist among the port parameters:

$$z_{12} = z_{21}, \quad (18.28)$$

$$y_{12} = y_{21}, \quad (18.29)$$

$$a_{11}a_{22} - a_{12}a_{21} = \Delta a = 1, \quad (18.30)$$

$$b_{11}b_{22} - b_{12}b_{21} = \Delta b = 1, \quad (18.31)$$

$$h_{12} = -h_{21}, \quad (18.32)$$

$$g_{12} = -g_{21}. \quad (18.33)$$

A two-port circuit is reciprocal if the interchange of an ideal voltage source at one port with an ideal ammeter at the other port produces the same ammeter reading. Consider, for example, the resistive circuit shown in Fig. 18.4. When a voltage source of 15 V is applied to port ad, it produces a current of 1.75 A in the ammeter at port cd. The ammeter current is easily determined once we know the voltage  $V_{bd}$ . Thus

$$\frac{V_{bd}}{60} + \frac{V_{bd} - 15}{30} + \frac{V_{bd}}{20} = 0, \quad (18.34)$$

and  $V_{bd} = 5$  V. Therefore

$$I = \frac{5}{20} + \frac{15}{10} = 1.75 \text{ A}. \quad (18.35)$$

If the voltage source and ammeter are interchanged, the ammeter will still read 1.75 A. We verify this by solving the circuit shown in Fig. 18.5:

$$\frac{V_{bd}}{60} + \frac{V_{bd}}{30} + \frac{V_{bd} - 15}{20} = 0. \quad (18.36)$$

From Eq. 18.36,  $V_{bd} = 7.5$  V. The current  $I_{ad}$  equals

$$I_{ad} = \frac{7.5}{30} + \frac{15}{10} = 1.75 \text{ A}. \quad (18.37)$$

A two-port circuit is also reciprocal if the interchange of an ideal current source at one port with an ideal voltmeter at the other port produces

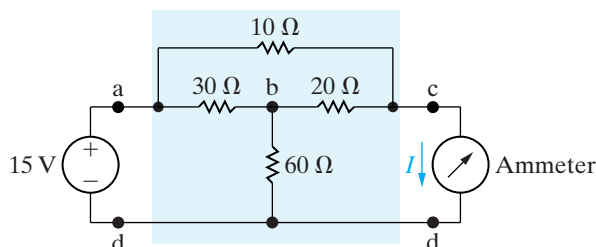


Figure 18.4 ▲ A reciprocal two-port circuit.

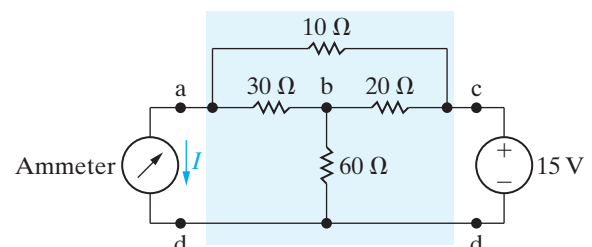
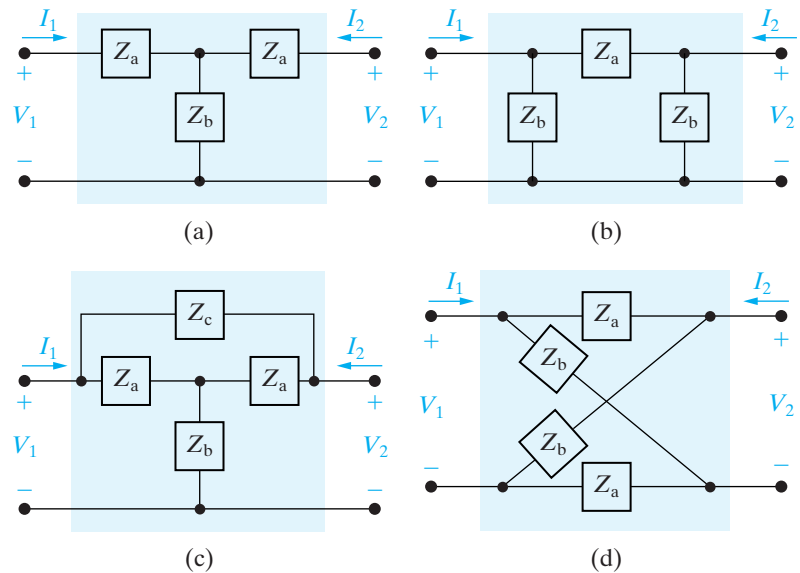


Figure 18.5 ▲ The circuit shown in Fig. 18.4, with the voltage source and ammeter interchanged.



**Figure 18.6** ▲ Four examples of symmetric two-port circuits. (a) A symmetric tee. (b) A symmetric pi. (c) A symmetric bridged tee. (d) A symmetric lattice.

the same voltmeter reading. For a reciprocal two-port circuit, only three calculations or measurements are needed to determine a set of parameters.

A reciprocal two-port circuit is **symmetric** if its ports can be interchanged without disturbing the values of the terminal currents and voltages. Figure 18.6 shows four examples of symmetric two-port circuits. In such circuits, the following additional relationships exist among the port parameters:

$$z_{11} = z_{22}, \quad (18.38)$$

$$y_{11} = y_{22}, \quad (18.39)$$

$$a_{11} = a_{22}, \quad (18.40)$$

$$b_{11} = b_{22}, \quad (18.41)$$

$$h_{11}h_{22} - h_{12}h_{21} = \Delta h = 1, \quad (18.42)$$

$$g_{11}g_{22} - g_{12}g_{21} = \Delta g = 1. \quad (18.43)$$

For a symmetric reciprocal network, only two calculations or measurements are necessary to determine all the two-port parameters.

## ✓ ASSESSMENT PROBLEM

**Objective 1**—Be able to calculate any set of two-port parameters

**18.5** The following measurements were made on a resistive two-port network that is symmetric and reciprocal: With port 2 open,  $V_1 = 95$  V and  $I_1 = 5$  A; with a short circuit across port 2,

$V_1 = 11.52$  V and  $I_2 = -2.72$  A. Calculate the  $z$  parameters of the two-port network.

**Answer:**  $z_{11} = z_{22} = 19 \Omega$ ,  $z_{12} = z_{21} = 17 \Omega$ .

*NOTE:* Also try Chapter Problem 18.14.

## 18.3 Analysis of the Terminated Two-Port Circuit

In the typical application of a two-port model, the circuit is driven at port 1 and loaded at port 2. Figure 18.7 shows the  $s$ -domain circuit diagram for a typically terminated two-port model. Here,  $Z_g$  represents the internal impedance of the source,  $V_g$  the internal voltage of the source, and  $Z_L$  the load impedance. Analysis of this circuit involves expressing the terminal currents and voltages as functions of the two-port parameters,  $V_g$ ,  $Z_g$ , and  $Z_L$ .

Six characteristics of the terminated two-port circuit define its terminal behavior:

- the input impedance  $Z_{in} = V_1/I_1$ , or the admittance  $Y_{in} = I_1/V_1$
- the output current  $I_2$
- the Thévenin voltage and impedance ( $V_{Th}$ ,  $Z_{Th}$ ) with respect to port 2
- the current gain  $I_2/I_1$
- the voltage gain  $V_2/V_1$
- the voltage gain  $V_2/V_g$

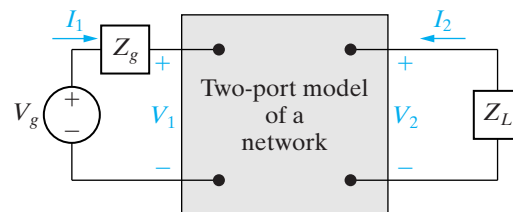


Figure 18.7 ▲ A terminated two-port model.

### The Six Characteristics in Terms of the $z$ Parameters

To illustrate how these six characteristics are derived, we develop the expressions using the  $z$  parameters to model the two-port portion of the circuit. Table 18.2 summarizes the expressions involving the  $y$ ,  $a$ ,  $b$ ,  $h$ , and  $g$  parameters.

The derivation of any one of the desired expressions involves the algebraic manipulation of the two-port equations along with the two constraint equations imposed by the terminations. If we use the  $z$ -parameter equations, the four that describe the circuit in Fig. 18.7 are

$$V_1 = z_{11}I_1 + z_{12}I_2, \quad (18.44)$$

$$V_2 = z_{21}I_1 + z_{22}I_2, \quad (18.45)$$

$$V_1 = V_g - I_1Z_g, \quad (18.46)$$

$$V_2 = -I_2Z_L. \quad (18.47)$$

Equations 18.46 and 18.47 describe the constraints imposed by the terminations.

To find the impedance seen looking into port 1, that is,  $Z_{in} = V_1/I_1$ , we proceed as follows. In Eq. 18.45 we replace  $V_2$  with  $-I_2Z_L$  and solve the resulting expression for  $I_2$ :

$$I_2 = \frac{-z_{21}I_1}{Z_L + z_{22}}. \quad (18.48)$$

TABLE 18.2 Terminated Two-Port Equations

**z Parameters**

$$Z_{\text{in}} = z_{11} - \frac{z_{12}z_{21}}{z_{22} + Z_L}$$

$$I_2 = \frac{-z_{21}V_g}{(z_{11} + Z_g)(z_{22} + Z_L) - z_{12}z_{21}}$$

$$V_{\text{Th}} = \frac{z_{21}}{z_{11} + Z_g}V_g$$

$$Z_{\text{Th}} = z_{22} - \frac{z_{12}z_{21}}{z_{11} + Z_g}$$

$$\frac{I_2}{I_1} = \frac{-z_{21}}{z_{22} + Z_L}$$

$$\frac{V_2}{V_1} = \frac{z_{21}Z_L}{z_{11}Z_L + \Delta z}$$

$$\frac{V_2}{V_g} = \frac{z_{21}Z_L}{(z_{11} + Z_g)(z_{22} + Z_L) - z_{12}z_{21}}$$

**a Parameters**

$$Z_{\text{in}} = \frac{a_{11}Z_L + a_{12}}{a_{21}Z_L + a_{22}}$$

$$I_2 = \frac{-V_g}{a_{11}Z_L + a_{12} + a_{21}Z_gZ_L + a_{22}Z_g}$$

$$V_{\text{Th}} = \frac{V_g}{a_{11} + a_{21}Z_g}$$

$$Z_{\text{Th}} = \frac{a_{12} + a_{22}Z_g}{a_{11} + a_{21}Z_g}$$

$$\frac{I_2}{I_1} = \frac{-1}{a_{21}Z_L + a_{22}}$$

$$\frac{V_2}{V_1} = \frac{Z_L}{a_{11}Z_L + a_{12}}$$

$$\frac{V_2}{V_g} = \frac{Z_L}{(a_{11} + a_{21}Z_g)Z_L + a_{12} + a_{22}Z_g}$$

**h Parameters**

$$Z_{\text{in}} = h_{11} - \frac{h_{12}h_{21}Z_L}{1 + h_{22}Z_L}$$

$$I_2 = \frac{h_{21}V_g}{(1 + h_{22}Z_L)(h_{11} + Z_g) - h_{12}h_{21}Z_L}$$

$$V_{\text{Th}} = \frac{-h_{21}V_g}{h_{22}Z_g + \Delta h}$$

$$Z_{\text{Th}} = \frac{Z_g + h_{11}}{h_{22}Z_g + \Delta h}$$

$$\frac{I_2}{I_1} = \frac{h_{21}}{1 + h_{22}Z_L}$$

$$\frac{V_2}{V_1} = \frac{-h_{21}Z_L}{\Delta hZ_L + h_{11}}$$

$$\frac{V_2}{V_g} = \frac{-h_{21}Z_L}{(h_{11} + Z_g)(1 + h_{22}Z_L) - h_{12}h_{21}Z_L}$$

**y Parameters**

$$Y_{\text{in}} = y_{11} - \frac{y_{12}y_{21}Z_L}{1 + y_{22}Z_L}$$

$$I_2 = \frac{y_{21}V_g}{1 + y_{22}Z_L + y_{11}Z_g + \Delta yZ_gZ_L}$$

$$V_{\text{Th}} = \frac{-y_{21}V_g}{y_{22} + \Delta yZ_g}$$

$$Z_{\text{Th}} = \frac{1 + y_{11}Z_g}{y_{22} + \Delta yZ_g}$$

$$\frac{I_2}{I_1} = \frac{y_{21}}{y_{11} + \Delta yZ_L}$$

$$\frac{V_2}{V_1} = \frac{-y_{21}Z_L}{1 + y_{22}Z_L}$$

$$\frac{V_2}{V_g} = \frac{y_{21}Z_L}{y_{12}y_{21}Z_gZ_L - (1 + y_{11}Z_g)(1 + y_{22}Z_L)}$$

**b Parameters**

$$Z_{\text{in}} = \frac{b_{22}Z_L + b_{12}}{b_{21}Z_L + b_{11}}$$

$$I_2 = \frac{-V_g\Delta b}{b_{11}Z_g + b_{21}Z_gZ_L + b_{22}Z_L + b_{12}}$$

$$V_{\text{Th}} = \frac{V_g\Delta b}{b_{22} + b_{21}Z_g}$$

$$Z_{\text{Th}} = \frac{b_{11}Z_g + b_{12}}{b_{21}Z_g + b_{22}}$$

$$\frac{I_2}{I_1} = \frac{-\Delta b}{b_{11} + b_{21}Z_L}$$

$$\frac{V_2}{V_1} = \frac{\Delta bZ_L}{b_{12} + b_{22}Z_L}$$

$$\frac{V_2}{V_g} = \frac{\Delta bZ_L}{b_{12} + b_{11}Z_g + b_{22}Z_L + b_{21}Z_gZ_L}$$

**g Parameters**

$$Y_{\text{in}} = g_{11} - \frac{g_{12}g_{21}}{g_{22} + Z_L}$$

$$I_2 = \frac{-g_{21}V_g}{(1 + g_{11}Z_g)(g_{22} + Z_L) - g_{12}g_{21}Z_g}$$

$$V_{\text{Th}} = \frac{g_{21}V_g}{1 + g_{11}Z_g}$$

$$Z_{\text{Th}} = g_{22} - \frac{g_{12}g_{21}Z_g}{1 + g_{11}Z_g}$$

$$\frac{I_2}{I_1} = \frac{-g_{21}}{g_{11}Z_L + \Delta g}$$

$$\frac{V_2}{V_1} = \frac{g_{21}Z_L}{g_{22} + Z_L}$$

$$\frac{V_2}{V_g} = \frac{g_{21}Z_L}{(1 + g_{11}Z_g)(g_{22} + Z_L) - g_{12}g_{21}Z_g}$$

We then substitute this equation into Eq. 18.44 and solve for  $Z_{\text{in}}$ :

$$Z_{\text{in}} = z_{11} - \frac{z_{12}z_{21}}{z_{22} + Z_L}. \quad (18.49)$$

To find the terminal current  $I_2$ , we first solve Eq. 18.44 for  $I_1$  after replacing  $V_1$  with the right-hand side of Eq. 18.46. The result is

$$I_1 = \frac{V_g - z_{12}I_2}{z_{11} + Z_g}. \quad (18.50)$$

We now substitute Eq. 18.50 into Eq. 18.48 and solve the resulting equation for  $I_2$ :

$$I_2 = \frac{-z_{21}V_g}{(z_{11} + Z_g)(z_{22} + Z_L) - z_{12}z_{21}}. \quad (18.51)$$

The Thévenin voltage with respect to port 2 equals  $V_2$  when  $I_2 = 0$ . With  $I_2 = 0$ , Eqs. 18.44 and 18.45 combine to yield

$$V_2|_{I_2=0} = z_{21}I_1 = z_{21} \frac{V_1}{z_{11}}. \quad (18.52)$$

But  $V_1 = V_g - I_1Z_g$ , and  $I_1 = V_g/(Z_g + z_{11})$ ; therefore substituting the results into Eq. 18.52 yields the open-circuit value of  $V_2$ :

$$V_2|_{I_2=0} = V_{\text{Th}} = \frac{z_{21}}{Z_g + z_{11}}V_g. \quad (18.53)$$

The Thévenin, or output, impedance is the ratio  $V_2/I_2$  when  $V_g$  is replaced by a short circuit. When  $V_g$  is zero, Eq. 18.46 reduces to

$$V_1 = -I_1Z_g. \quad (18.54)$$

Substituting Eq. 18.54 into Eq. 18.44 gives

$$I_1 = \frac{-z_{12}I_2}{z_{11} + Z_g}. \quad (18.55)$$

We now use Eq. 18.55 to replace  $I_1$  in Eq. 18.45, with the result that

$$\left. \frac{V_2}{I_2} \right|_{V_g=0} = Z_{\text{Th}} = z_{22} - \frac{z_{12}z_{21}}{z_{11} + Z_g}. \quad (18.56)$$

The current gain  $I_2/I_1$  comes directly from Eq. 18.48:

$$\frac{I_2}{I_1} = \frac{-z_{21}}{Z_L + z_{22}}. \quad (18.57)$$

To derive the expression for the voltage gain  $V_2/V_1$ , we start by replacing  $I_2$  in Eq. 18.45 with its value from Eq. 18.47; thus

$$V_2 = z_{21}I_1 + z_{22} \left( \frac{-V_2}{Z_L} \right). \quad (18.58)$$

Next we solve Eq. 18.44 for  $I_1$  as a function of  $V_1$  and  $V_2$ :

$$z_{11}I_1 = V_1 - z_{12}\left(\frac{-V_2}{Z_L}\right)$$

or

$$I_1 = \frac{V_1}{z_{11}} + \frac{z_{12}V_2}{z_{11}Z_L}. \quad (18.59)$$

We now replace  $I_1$  in Eq. 18.58 with Eq. 18.59 and solve the resulting expression for  $V_2/V_1$ :

$$\begin{aligned} \frac{V_2}{V_1} &= \frac{z_{21}Z_L}{z_{11}Z_L + z_{11}z_{22} - z_{12}z_{21}} \\ &= \frac{z_{21}Z_L}{z_{11}Z_L + \Delta z}. \end{aligned} \quad (18.60)$$

To derive the voltage ratio  $V_2/V_g$ , we first combine Eqs. 18.44, 18.46, and 18.47 to find  $I_1$  as a function of  $V_2$  and  $V_g$ :

$$I_1 = \frac{z_{12}V_2}{Z_L(z_{11} + Z_g)} + \frac{V_g}{z_{11} + Z_g}. \quad (18.61)$$

We now use Eqs. 18.61 and 18.47 in conjunction with Eq. 18.45 to derive an expression involving only  $V_2$  and  $V_g$ ; that is,

$$V_2 = \frac{z_{21}z_{12}V_2}{Z_L(z_{11} + Z_g)} + \frac{z_{21}V_g}{z_{11} + Z_g} - \frac{z_{22}}{Z_L}V_2, \quad (18.62)$$

which we can manipulate to get the desired voltage ratio:

$$\frac{V_2}{V_g} = \frac{z_{21}Z_L}{(z_{11} + Z_g)(z_{22} + Z_L) - z_{12}z_{21}}. \quad (18.63)$$

The first entries in Table 18.2 summarize the expressions for these six attributes of the terminated two-port circuit. Also listed are the corresponding expressions in terms of the  $y$ ,  $a$ ,  $b$ ,  $h$ , and  $g$  parameters.

Example 18.4 illustrates the usefulness of the relationships listed in Table 18.2.

### Example 18.4 Analyzing a Terminated Two-Port Circuit

The two-port circuit shown in Fig. 18.8 is described in terms of its  $b$  parameters, the values of which are

$$\begin{aligned} b_{11} &= -20, & b_{12} &= -3000 \, \Omega, \\ b_{21} &= -2 \text{ mS}, & b_{22} &= -0.2. \end{aligned}$$

- Find the phasor voltage  $V_2$ .
- Find the average power delivered to the  $5 \text{ k}\Omega$  load.
- Find the average power delivered to the input port.

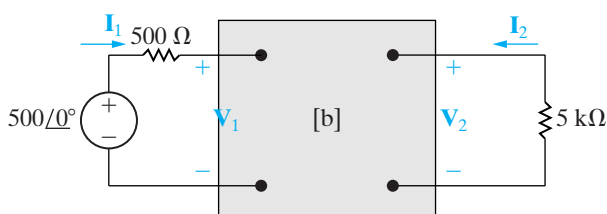


Figure 18.8 ▲ The circuit for Example 18.4.

- Find the load impedance for maximum average power transfer.
- Find the maximum average power delivered to the load in (d).

### Solution

- To find  $V_2$ , we have two choices from the entries in Table 18.2. We may choose to find  $I_2$  and then find  $V_2$  from the relationship  $V_2 = -I_2Z_L$ , or we may find the voltage gain  $V_2/V_g$  and calculate  $V_2$  from the gain. Let's use the latter approach. For the  $b$ -parameter values given, we have

$$\begin{aligned} \Delta b &= (-20)(-0.2) - (-3000)(-2 \times 10^{-3}) \\ &= 4 - 6 = -2. \end{aligned}$$

From Table 18.2,

$$\begin{aligned}\frac{\mathbf{V}_2}{\mathbf{V}_g} &= \frac{\Delta b Z_L}{b_{12} + b_{11} Z_g + b_{22} Z_L + b_{21} Z_g Z_L} \\ &= \frac{(-2)(5000)}{-3000 + (-20)500 + (-0.2)5000 + [-2 \times 10^{-3}(500)(5000)]} \\ &= \frac{10}{19}.\end{aligned}$$

Then,

$$\mathbf{V}_2 = \left(\frac{10}{19}\right)500 = 263.16 \angle 0^\circ \text{ V}.$$

b) The average power delivered to the 5000  $\Omega$  load is

$$P_2 = \frac{263.16^2}{2(5000)} = 6.93 \text{ W}.$$

c) To find the average power delivered to the input port, we first find the input impedance  $Z_{\text{in}}$ . From Table 18.2,

$$\begin{aligned}Z_{\text{in}} &= \frac{b_{22} Z_L + b_{12}}{b_{21} Z_L + b_{11}} \\ &= \frac{(-0.2)(5000) - 3000}{-2 \times 10^{-3}(5000) - 20} \\ &= \frac{400}{3} = 133.33 \Omega.\end{aligned}$$

Now  $\mathbf{I}_1$  follows directly:

$$\mathbf{I}_1 = \frac{500}{500 + 133.33} = 789.47 \text{ mA}.$$

The average power delivered to the input port is

$$P_1 = \frac{0.78947^2}{2}(133.33) = 41.55 \text{ W}.$$

d) The load impedance for maximum power transfer equals the conjugate of the Thévenin impedance seen looking into port 2. From Table 18.2,

$$\begin{aligned}Z_{\text{Th}} &= \frac{b_{11} Z_g + b_{12}}{b_{21} Z_g + b_{22}} \\ &= \frac{(-20)(500) - 3000}{(-2 \times 10^{-3})(500) - 0.2} \\ &= \frac{13,000}{1.2} = 10,833.33 \Omega.\end{aligned}$$

Therefore  $Z_L = Z_{\text{Th}}^* = 10,833.33 \Omega$ .

e) To find the maximum average power delivered to  $Z_L$ , we first find  $\mathbf{V}_2$  from the voltage-gain expression  $\mathbf{V}_2/\mathbf{V}_g$ . When  $Z_L$  is 10,833.33  $\Omega$ , this gain is

$$\frac{\mathbf{V}_2}{\mathbf{V}_g} = 0.8333.$$

Thus

$$\mathbf{V}_2 = (0.8333)(500) = 416.67 \text{ V},$$

and

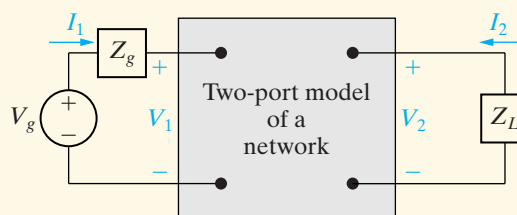
$$\begin{aligned}P_L(\text{maximum}) &= \frac{1}{2} \frac{416.67^2}{10,833.33} \\ &= 8.01 \text{ W}.\end{aligned}$$

## ASSESSMENT PROBLEM

**Objective 2**—Be able to analyze a terminated two-port circuit to find currents, voltages, and ratios of interest

**18.6** The  $a$  parameters of the two-port network shown are  $a_{11} = 5 \times 10^{-4}$ ,  $a_{12} = 10 \Omega$ ,  $a_{21} = 10^{-6} \text{ S}$ , and  $a_{22} = -3 \times 10^{-2}$ . The network is driven by a sinusoidal voltage source having a maximum amplitude of 50 mV and an internal impedance of  $100 + j0 \Omega$ . It is terminated in a resistive load of 5 k $\Omega$ .

- Calculate the average power delivered to the load resistor.
- Calculate the load resistance for maximum average power.
- Calculate the maximum average power delivered to the resistor in (b).



**Answer:** (a) 62.5 mW;  
(b) 70/6 k $\Omega$ ;  
(c) 74.4 mW.

*NOTE:* Also try Chapter Problems 18.29, 18.31, and 18.33.



## 18.4 Interconnected Two-Port Circuits

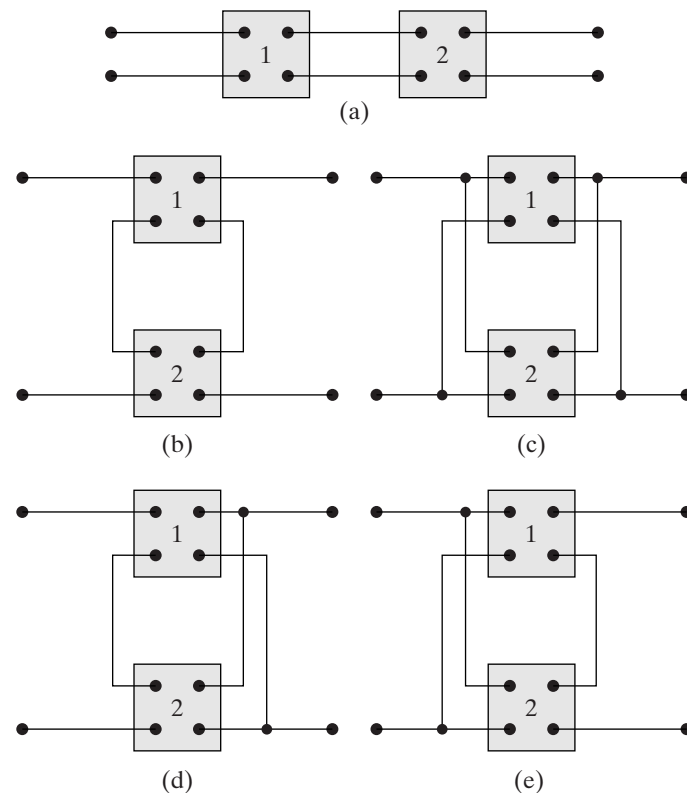
Synthesizing a large, complex system is usually made easier by first designing subsections of the system. Interconnecting these simpler, easier-to-design units then completes the system. If the subsections are modeled by two-port circuits, synthesis involves the analysis of interconnected two-port circuits.

Two-port circuits may be interconnected five ways: (1) in cascade, (2) in series, (3) in parallel, (4) in series-parallel, and (5) in parallel-series. Figure 18.9 depicts these five basic interconnections.

We analyze and illustrate only the cascade connection in this section. However, if the four other connections meet certain requirements, we can obtain the parameters that describe the interconnected circuits by simply adding the individual network parameters. In particular, the  $z$  parameters describe the series connection, the  $y$  parameters the parallel connection, the  $h$  parameters the series-parallel connection, and the  $g$  parameters the parallel-series connection.<sup>1</sup>

The cascade connection is important because it occurs frequently in the modeling of large systems. Unlike the other four basic interconnections, there are no restrictions on using the parameters of the individual two-port circuits to obtain the parameters of the interconnected circuits. The  $a$  parameters are best suited for describing the cascade connection.

We analyze the cascade connection by using the circuit shown in Fig. 18.10, where a single prime denotes  $a$  parameters in the first circuit and a double prime denotes  $a$  parameters in the second circuit. The output



**Figure 18.9** ▲ The five basic interconnections of two-port circuits. (a) Cascade. (b) Series. (c) Parallel. (d) Series-parallel. (e) Parallel-series.

<sup>1</sup> A detailed discussion of these four interconnections is presented in Henry Ruston and Joseph Bordogna, *Electric Networks: Functions, Filters, Analysis* (New York: McGraw-Hill, 1966), ch. 4.

voltage and current of the first circuit are labeled  $V'_2$  and  $I'_2$ , and the input voltage and current of the second circuit are labeled  $V'_1$  and  $I'_1$ . The problem is to derive the  $a$ -parameter equations that relate  $V_2$  and  $I_2$  to  $V_1$  and  $I_1$ . In other words, we seek the pair of equations

$$V_1 = a_{11}V_2 - a_{12}I_2 \quad (18.64)$$

$$I_1 = a_{21}V_2 - a_{22}I_2, \quad (18.65)$$

where the  $a$  parameters are given explicitly in terms of the  $a$  parameters of the individual circuits.

We begin the derivation by noting from Fig. 18.10 that

$$V_1 = a'_{11}V'_2 - a'_{12}I'_2, \quad (18.66)$$

$$I_1 = a'_{21}V'_2 - a'_{22}I'_2. \quad (18.67)$$

The interconnection means that  $V'_2 = V'_1$  and  $I'_2 = -I'_1$ . Substituting these constraints into Eqs. 18.66 and Eqs. 18.67 yields

$$V_1 = a'_{11}V'_1 + a'_{12}I'_1, \quad (18.68)$$

$$I_1 = a'_{21}V'_1 + a'_{22}I'_1. \quad (18.69)$$

The voltage  $V'_1$  and the current  $I'_1$  are related to  $V_2$  and  $I_2$  through the  $a$  parameters of the second circuit:

$$V'_1 = a''_{11}V_2 - a''_{12}I_2, \quad (18.70)$$

$$I'_1 = a''_{21}V_2 - a''_{22}I_2. \quad (18.71)$$

We substitute Eqs. 18.70 and 18.71 into Eqs. 18.68 and 18.69 to generate the relationships between  $V_1$ ,  $I_1$  and  $V_2$ ,  $I_2$ :

$$V_1 = (a'_{11}a''_{11} + a'_{12}a''_{21})V_2 - (a'_{11}a''_{12} + a'_{12}a''_{22})I_2, \quad (18.72)$$

$$I_1 = (a'_{21}a''_{11} + a'_{22}a''_{21})V_2 - (a'_{21}a''_{12} + a'_{22}a''_{22})I_2. \quad (18.73)$$

By comparing Eqs. 18.72 and 18.73 to Eqs. 18.64 and 18.65, we get the desired expressions for the  $a$  parameters of the interconnected networks, namely,

$$a_{11} = a'_{11}a''_{11} + a'_{12}a''_{21}, \quad (18.74)$$

$$a_{12} = a'_{11}a''_{12} + a'_{12}a''_{22}, \quad (18.75)$$

$$a_{21} = a'_{21}a''_{11} + a'_{22}a''_{21}, \quad (18.76)$$

$$a_{22} = a'_{21}a''_{12} + a'_{22}a''_{22}. \quad (18.77)$$

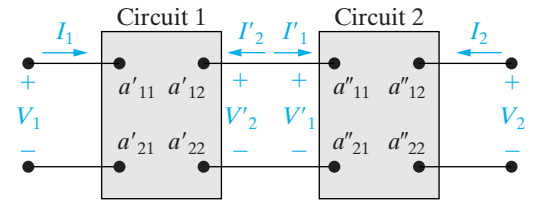


Figure 18.10 ▲ A cascade connection.

If more than two units are connected in cascade, the  $a$  parameters of the equivalent two-port circuit can be found by successively reducing the original set of two-port circuits one pair at a time.

Example 18.5 illustrates how to use Eqs. 18.74–18.77 to analyze a cascade connection with two amplifier circuits.

### Example 18.5 Analyzing Cascaded Two-Port Circuits

Two identical amplifiers are connected in cascade, as shown in Fig. 18.11. Each amplifier is described in terms of its  $h$  parameters. The values are  $h_{11} = 1000 \Omega$ ,  $h_{12} = 0.0015$ ,  $h_{21} = 100$ , and  $h_{22} = 100 \mu\text{S}$ . Find the voltage gain  $V_2/V_g$ .

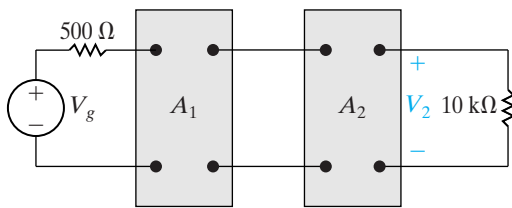


Figure 18.11 ▲ The circuit for Example 18.5.

#### Solution

The first step in finding  $V_2/V_g$  is to convert from  $h$  parameters to  $a$  parameters. The amplifiers are identical, so one set of  $a$  parameters describes the amplifiers:

$$a'_{11} = \frac{-\Delta h}{h_{21}} = \frac{+0.05}{100} = 5 \times 10^{-4},$$

$$a'_{12} = \frac{-h_{11}}{h_{21}} = \frac{-1000}{100} = -10 \Omega,$$

$$a'_{21} = \frac{-h_{22}}{h_{21}} = \frac{-100 \times 10^{-6}}{100} = -10^{-6} \text{ S},$$

$$a'_{22} = \frac{-1}{h_{21}} = \frac{-1}{100} = -10^{-2}.$$

Next we use Eqs. 18.74–18.77 to compute the  $a$  parameters of the cascaded amplifiers:

$$\begin{aligned} a_{11} &= a'_{11}a'_{11} + a'_{12}a'_{21} \\ &= 25 \times 10^{-8} + (-10)(-10^{-6}) \end{aligned}$$

$$= 10.25 \times 10^{-6},$$

$$a_{12} = a'_{11}a'_{12} + a'_{12}a'_{22}$$

$$= (5 \times 10^{-4})(-10) + (-10)(-10^{-2})$$

$$= 0.095 \Omega,$$

$$a_{21} = a'_{21}a'_{11} + a'_{22}a'_{21}$$

$$= (-10^{-6})(5 \times 10^{-4}) + (-0.01)(-10^{-6})$$

$$= 9.5 \times 10^{-9} \text{ S},$$

$$a_{22} = a'_{21}a'_{12} + a'_{22}a'_{22}$$

$$= (-10^{-6})(-10) + (-10^{-2})^2$$

$$= 1.1 \times 10^{-4}.$$

From Table 18.2,

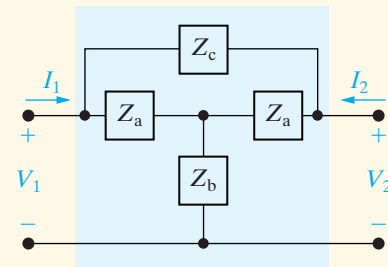
$$\begin{aligned} \frac{V_2}{V_g} &= \frac{Z_L}{(a_{11} + a_{21}Z_g)Z_L + a_{12} + a_{22}Z_g} \\ &= \frac{10^4}{[10.25 \times 10^{-6} + 9.5 \times 10^{-9}(500)]10^4 + 0.095 + 1.1 \times 10^{-4}(500)} \\ &= \frac{10^4}{0.15 + 0.095 + 0.055} \\ &= \frac{10^5}{3} \\ &= 33,333.33. \end{aligned}$$

Thus an input signal of  $150 \mu\text{V}$  is amplified to an output signal of  $5 \text{ V}$ . For an alternative approach to finding the voltage gain  $V_2/V_g$ , see Problem 18.41.

## ASSESSMENT PROBLEM

### Objective 3—Know how to analyze a cascade interconnection of two-port circuits

**18.7** Each element in the symmetric bridged-tee circuit shown is a  $15\ \Omega$  resistor. Two of these bridged tees are connected in cascade between a dc voltage source and a resistive load. The dc voltage source has a no load voltage of  $100\ \text{V}$  and an internal resistance of  $8\ \Omega$ . The load resistor is adjusted until maximum power is delivered to the load. Calculate (a) the load resistance, (b) the load voltage, and (c) the load power.



**Answer:** (a)  $14.44\ \Omega$ ;  
 (b)  $16\ \text{V}$ ;  
 (c)  $17.73\ \text{W}$ .

*NOTE: Also try Chapter Problem 18.38.*

## Practical Perspective

### Characterizing an Unknown Circuit

We make the following measurements to find the  $h$  parameters for our "black box" amplifier:

With Port 1 open, apply  $50\ \text{V}$  at Port 2. Measure the voltage at Port 1 and the current at Port 2:

$$V_1 = 50\ \text{mV}; \quad I_2 = 2.5\ \text{A}.$$

With Port 2 short-circuited, apply  $2.5\ \text{mA}$  at Port 1. Measure the voltage at Port 1 and the current at Port 2:

$$V_1 = 1.25\ \text{V}; \quad I_2 = 3.75\ \text{A}.$$

Calculate the  $h$  parameters according to Eq. 18.14:

$$h_{11} = \left. \frac{V_1}{I_1} \right|_{V_2=0} = \frac{1.25}{0.0025} = 500\ \Omega; \quad h_{12} = \left. \frac{V_1}{V_2} \right|_{I_1=0} = \frac{0.05}{50} = 10^{-3};$$

$$h_{21} = \left. \frac{I_2}{I_1} \right|_{V_2=0} = \frac{3.75}{0.0025} = 1500; \quad h_{22} = \left. \frac{I_2}{V_2} \right|_{I_1=0} = \frac{2.5}{50} = 50\ \text{mS}.$$

Now we use the terminated two-port equations to determine whether or not it is safe to attach a  $2\ \text{V(rms)}$  source with a  $100\ \Omega$  internal impedance to Port 1 and use this source together with the amplifier to drive a speaker modeled as a  $32\ \Omega$  resistance with a power rating of  $100\ \text{W}$ . Here we find the value of  $I_2$  from Table 18.2:

$$\begin{aligned} I_2 &= \frac{h_{21}V_g}{(1 + h_{22}Z_L)(h_{11} + Z_g) - h_{12}h_{21}Z_L} \\ &= \frac{1500(2)}{[1 + (0.05)(32)][500 + 100] - (1500)(10^{-3})(32)} \\ &= 1.98\ \text{A(rms)} \end{aligned}$$

Calculate the power to the  $32\ \Omega$  speaker:

$$P = RI_2^2 = (32)(1.98)^2 = 126\ \text{W}.$$

The amplifier would thus deliver  $126\ \text{W}$  to the speaker, which is rated at  $100\ \text{W}$ , so it would be better to use a different amplifier or buy a more powerful speaker.

## Summary

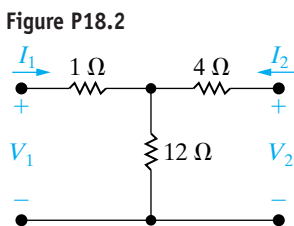
- The **two-port model** is used to describe the performance of a circuit in terms of the voltage and current at its input and output ports. (See page 676.)
- The model is limited to circuits in which
  - no independent sources are inside the circuit between the ports;
  - no energy is stored inside the circuit between the ports;
  - the current into the port is equal to the current out of the port; and
  - no external connections exist between the input and output ports.
 (See page 676.)
- Two of the four terminal variables ( $V_1$ ,  $I_1$ ,  $V_2$ ,  $I_2$ ) are independent; therefore, only two simultaneous equations involving the four variables are needed to describe the circuit. (See page 678.)
- The six possible sets of simultaneous equations involving the four terminal variables are called the  $z$ -,  $y$ -,  $a$ -,  $b$ -,  $h$ -, and  $g$ -parameter equations. See Eqs. 18.1–18.6. (See page 678.)
- The parameter equations are written in the  $s$  domain. The dc values of the parameters are obtained by setting  $s = 0$ , and the sinusoidal steady-state values are obtained by setting  $s = j\omega$ . (See page 678.)
- Any set of parameters may be calculated or measured by invoking appropriate short-circuit and open-circuit conditions at the input and output ports. See Eqs. 18.7–18.15. (See pages 679 and 680.)
- The relationships among the six sets of parameters are given in Table 18.1. (See page 682.)
- A two-port circuit is **reciprocal** if the interchange of an ideal voltage source at one port with an ideal ammeter at the other port produces the same ammeter reading. The effect of reciprocity on the two-port parameters is given by Eqs. 18.28–18.33. (See page 685.)
- A reciprocal two-port circuit is **symmetric** if its ports can be interchanged without disturbing the values of the terminal currents and voltages. The added effect of symmetry on the two-port parameters is given by Eqs. 18.38–18.43. (See page 686)
- The performance of a two-port circuit connected to a Thévenin equivalent source and a load is summarized by the relationships given in Table 18.2. (See page 688.)
- Large networks can be divided into subnetworks by means of interconnected two-port models. The cascade connection was used in this chapter to illustrate the analysis of interconnected two-port circuits. (See page 692.)

## Problems

### Sections 18.1–18.2

**18.1** Find the  $h$  and  $g$  parameters for the circuit in Example 18.1.

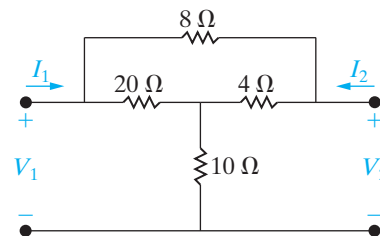
**18.2** Find the  $z$  parameters for the circuit in Fig. P18.2.



**18.3** Use the results obtained in Problem 18.2 to calculate the  $y$  parameters for the circuit in Fig. P18.2.

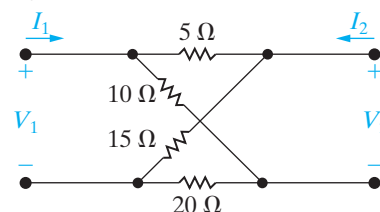
**18.4** Find the  $y$  parameters for the circuit shown in Fig. P18.4.

Figure P18.4



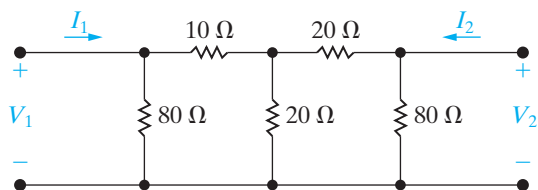
**18.5** Find the  $b$  parameters for the circuit shown in Fig. P18.5.

Figure P18.5



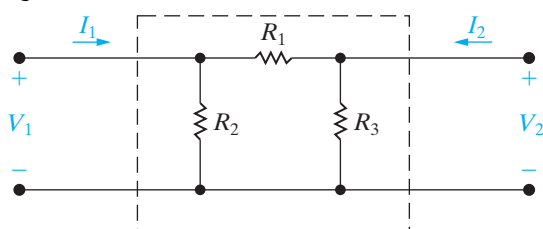
18.6 Find the  $h$  parameters for the circuit in Fig. P18.6.

Figure P18.6



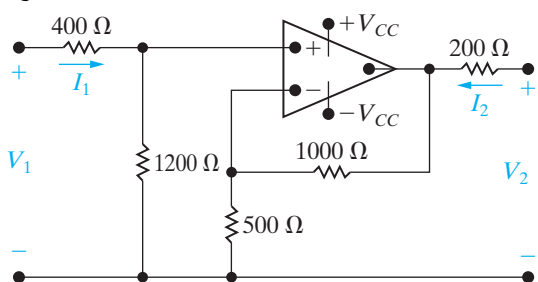
18.7 Select the values of  $R_1$ ,  $R_2$ , and  $R_3$  in the circuit in Fig. P18.7 so that  $h_{11} = 4 \Omega$ ,  $h_{12} = 0.8$ ,  $h_{21} = -0.8$ , and  $h_{22} = 0.14 \text{ S}$ .

Figure P18.7



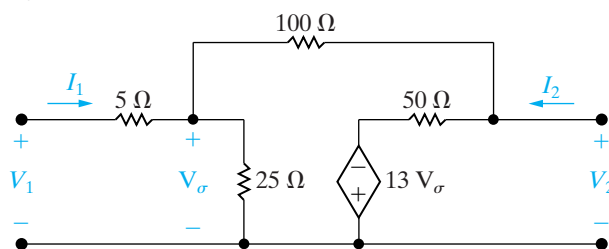
18.8 The operational amplifier in the circuit shown in Fig. P18.8 is ideal. Find the  $h$  parameters of the circuit.

Figure P18.8



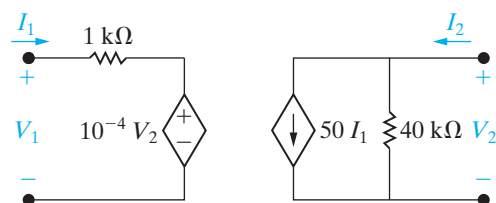
18.9 Find the  $g$  parameters for the operational amplifier circuit shown in Fig. P18.9.

Figure P18.9



18.10 Find the  $a$  parameters for the circuit in Fig. P18.10.

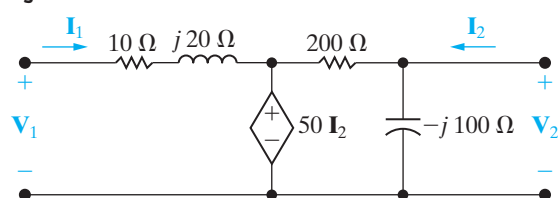
Figure P18.10



18.11 Use the results obtained in Problem 18.10 to calculate the  $g$  parameters of the circuit in Fig. P18.10.

18.12 Find the  $h$  parameters of the two-port circuit shown in Fig. P18.12.

Figure P18.12



18.13 The following direct-current measurements were made on the two-port network shown in Fig. P18.13.

Port 2 Open

$$V_1 = 20 \text{ mV}$$

$$V_2 = -5 \text{ V}$$

$$I_1 = 0.25 \mu\text{A}$$

Port 2 Short-Circuited

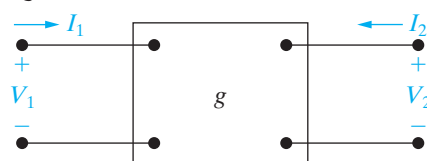
$$I_1 = 200 \mu\text{A}$$

$$I_2 = 50 \mu\text{A}$$

$$V_1 = 10 \text{ V}$$

Calculate the  $g$  parameters for the network.

Figure P18.13



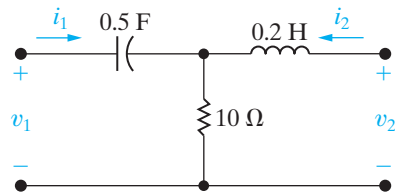
18.14 a) Use the measurements given in Problem 18.13 to find the  $y$  parameters for the network.

b) Check your calculations by finding the  $y$  parameters directly from the  $g$  parameters found in Problem 18.4.

18.15 Derive the expressions for the  $g$  parameters as functions of the  $h$  parameters.

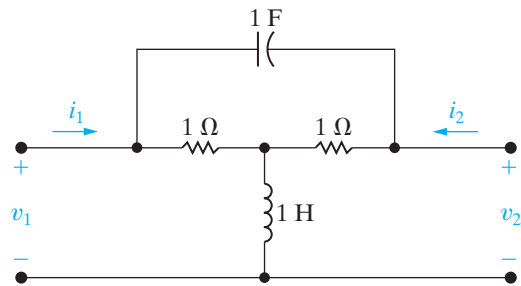
- 18.16 Derive the expressions for the  $h$  parameters as functions of the  $a$  parameters.
- 18.17 Derive the expressions for the  $y$  parameters as functions of the  $g$  parameters.
- 18.18 Find the  $s$ -domain expressions for the  $z$  parameters of the two-port circuit shown in Fig. P18.18.

Figure P18.18



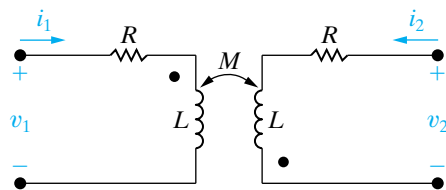
- 18.19 Find the  $s$ -domain expressions for the  $y$  parameters of the two-port circuit shown in Fig. P18.19.

Figure P18.19



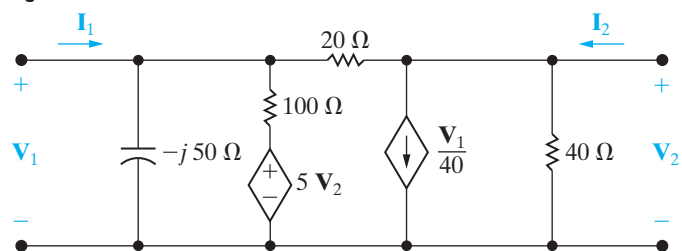
- 18.20 a) Use the defining equations to find the  $s$ -domain expressions for the  $a$  parameters for the circuit in Fig. P18.20.
- b) Show that the results obtained in (a) agree with the  $a$ -parameter relationships for a reciprocal symmetric network.

Figure P18.20



- 18.21 Find the frequency-domain values of the  $a$  parameters for the two-port circuit shown in Fig. P18.21.

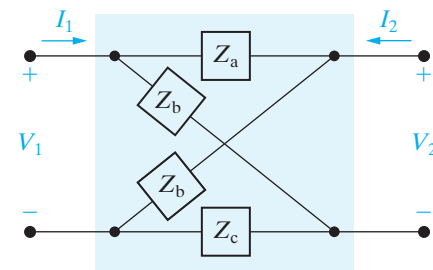
Figure P18.21



- 18.22 Find the  $h$  parameters for the two-port circuit shown in Fig. P18.21.

- 18.23 Is the two-port circuit shown in Fig. P18.23 symmetric? Justify your answer.

Figure P18.23



**Section 18.3**

- 18.24 Derive the expression for the voltage gain  $V_2/V_1$  of the circuit in Fig. 18.7 in terms of the  $a$  parameters.

- 18.25 Derive the expression for the input admittance ( $Y_{in} = I_1/V_1$ ) of the circuit in Fig. 18.7 in terms of the  $y$  parameters.

- 18.26 Derive the expression for the current gain  $I_2/I_1$  of the circuit in Fig. 18.7 in terms of the  $h$  parameters.

- 18.27 Find the Thévenin equivalent circuit with respect to port 2 of the circuit in Fig. 18.7 in terms of the  $g$  parameters.

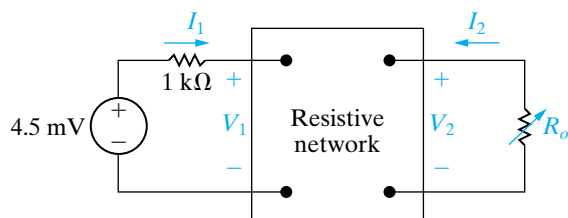
- 18.28 Derive the expression for the voltage gain  $V_2/V_g$  of the circuit in Fig. 18.7 in terms of the  $b$  parameters.

- 18.29 The following dc measurements were made on the resistive network shown in Fig. P18.29.

Measurement 1	Measurement 2
$V_1 = 0.1 \text{ V}$	$V_1 = 0 \text{ V}$
$I_1 = 100 \mu\text{A}$	$I_1 = -25 \mu\text{A}$
$V_2 = 200 \text{ V}$	$V_2 = 200 \text{ V}$
$I_2 = 0 \text{ A}$	$I_2 = 5 \text{ mA}$

A variable resistor  $R_o$  is connected across port 2 and adjusted for maximum power transfer to  $R_o$ . Find the maximum power.

Figure P18.29



- 18.30** The  $g$  parameters for the two-port circuit in Fig. P18.30 are

$$g_{11} = \frac{1}{6} - j\frac{1}{6} \text{ S}; \quad g_{12} = -0.5 + j0.5;$$

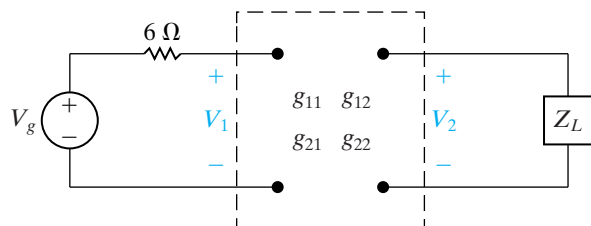
$$g_{21} = 0.5 - j0.5; \quad g_{22} = 1.5 + j2.5 \Omega.$$

The load impedance  $Z_L$  is adjusted for maximum average power transfer to  $Z_L$ . The ideal voltage source is generating a sinusoidal voltage of

$$v_g = 42\sqrt{2} \cos 5000t \text{ V}.$$

- Find the rms value of  $V_2$ .
- Find the average power delivered to  $Z_L$ .
- What percentage of the average power developed by the ideal voltage source is delivered by  $Z_L$ ?

Figure P18.30



- 18.31** The  $y$  parameters for the two-port amplifier circuit in Fig. P18.31 are

$$y_{11} = 2 \text{ mS}; \quad y_{12} = -2 \mu\text{S};$$

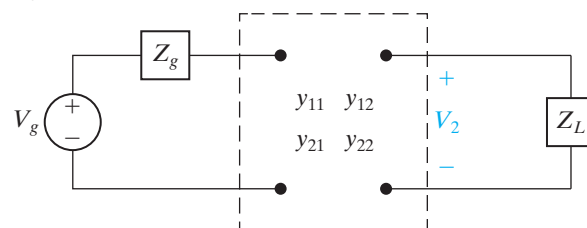
$$y_{21} = 100 \text{ mS}; \quad y_{22} = -50 \mu\text{S}.$$

The internal impedance of the source is  $2500 + j0 \Omega$ , and the load impedance is  $70,000 + j0 \Omega$ . The ideal voltage source is generating a voltage

$$v_g = 80\sqrt{2} \cos 4000t \text{ mV}.$$

- Find the rms value of  $V_2$ .
- Find the average power delivered to  $Z_L$ .
- Find the average power developed by the ideal voltage source.

Figure P18.31



- 18.32** For the terminated two-port amplifier circuit in Fig. P18.31, find

- the value of  $Z_L$  for maximum average power transfer to  $Z_L$
- the maximum average power delivered to  $Z_L$
- the average power developed by the ideal voltage source when maximum power is delivered to  $Z_L$ .

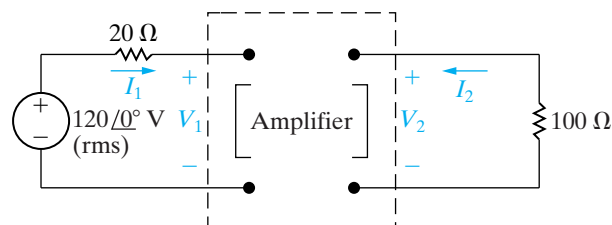
- 18.33** The  $b$  parameters of the amplifier in the circuit shown in Fig. P18.33 are

$$b_{11} = 25; \quad b_{12} = 1 \text{ k}\Omega;$$

$$b_{21} = -1.25 \text{ S}; \quad b_{22} = -40.$$

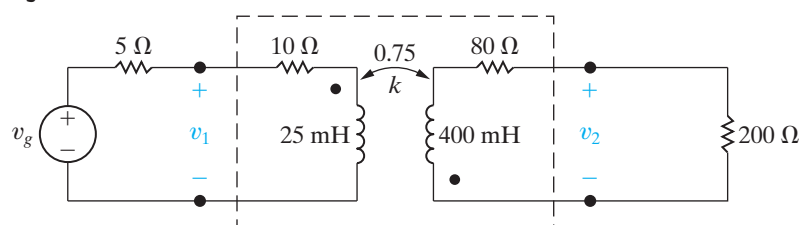
Find the ratio of the output power to that supplied by the ideal voltage source.

Figure P18.33



- 18.34** The linear transformer in the circuit shown in Fig. P18.34 has a coefficient of coupling of 0.75. The transformer is driven by a sinusoidal voltage source whose internal voltage is  $v_g = 80 \cos 400t \text{ V}$ . The internal impedance of the source is  $5 + j0 \Omega$ .

Figure P18.34





- a) Find the frequency-domain  $a$  parameters of the linear transformer.
- b) Use the  $a$  parameters to derive the Thévenin equivalent circuit with respect to the terminals of the load.
- c) Derive the steady-state time-domain expression for  $v_2$ .

**18.35** The following measurements were made on a resistive two-port network:

Condition 1 – create a short circuit at port 2 and apply 20 V to port 1:

Measurements:  $I_1 = 1$  A;  $I_2 = -1$  A.

Condition 2 – create an open circuit at port 1 and apply 80 V to port 2:

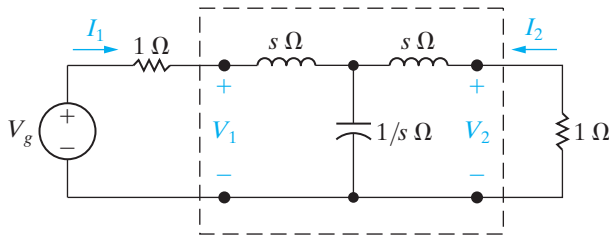
Measurements:  $V_1 = 400$  V;  $I_2 = 3$  A.

Find the maximum power that this two-port circuit can deliver to a resistive load at port 2 when port 1 is driven by a 4 A dc current source with an internal resistance of 60  $\Omega$ .

**18.36** a) Find the  $y$  parameters for the two-port network in Fig. P18.36.

b) Find  $v_2$  for  $t > 0$  when  $v_g = 10e^{-2t}u(t)$  V.

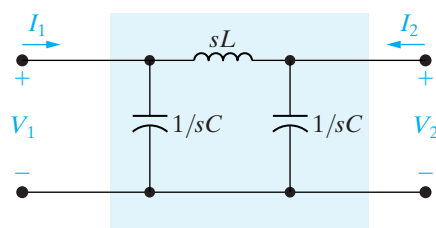
Figure P18.36



**18.37** a) Find the  $s$ -domain expressions for the  $g$  parameters of the circuit in Fig. P18.37.

b) Port 2 in Fig. P18.37 is terminated in a resistance of 500  $\Omega$ , and port 1 is driven by a step voltage source  $v_1(t) = 4u(t)$  V. Find  $v_2(t)$  for  $t > 0$  if  $C = 32$  nF and  $L = 50$  mH.

Figure P18.37



**Section 18.4**

**18.38** The  $z$  and  $y$  parameters for the resistive two-ports in Fig. P18.38 are given by

$$z_{11} = \frac{35}{3} \Omega; \quad y_{11} = 200 \mu\text{S};$$

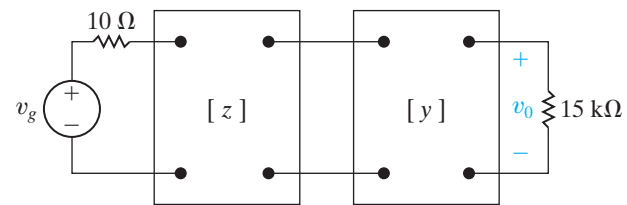
$$z_{12} = -\frac{100}{3} \Omega; \quad y_{12} = 40 \mu\text{S};$$

$$z_{21} = \frac{4}{3} \text{k}\Omega; \quad y_{21} = -800 \mu\text{S}$$

$$z_{22} = \frac{10}{3} \text{k}\Omega; \quad y_{22} = 40 \mu\text{S};$$

Calculate  $v_o$  if  $v_g = 30$  mV dc.

Figure P18.38



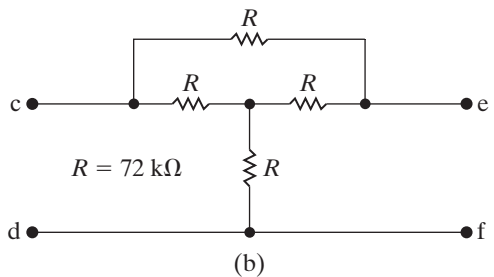
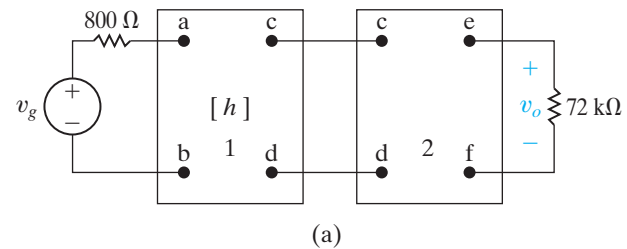
**18.39** The  $h$  parameters of the first two-port circuit in Fig. P18.39(a) are

$$h_{11} = 1000 \Omega; \quad h_{12} = 5 \times 10^{-4};$$

$$h_{21} = 40; \quad h_{22} = 25 \mu\text{S}.$$

The circuit in the second two-port circuit is shown in Fig. P18.39(b), where  $R = 72$  k $\Omega$ . Find  $v_o$  if  $v_g = 9$  mV dc.

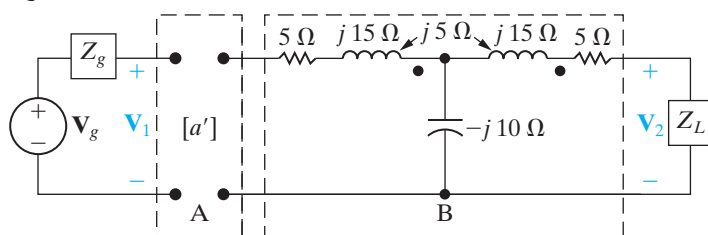
Figure P18.39



**18.40** The networks A and B in the circuit in Fig. P18.40 are reciprocal and symmetric. For network A, it is known that  $a'_{11} = 5$  and  $a'_{12} = 24 \Omega$ .

- Find the  $a$  parameters of network B.
- Find  $\mathbf{V}_2$  when  $\mathbf{V}_g = 75 \angle 0^\circ \text{ V}$ ,  $Z_g = 1 \angle 0^\circ \Omega$ , and  $Z_L = 10 \angle 0^\circ \Omega$ .

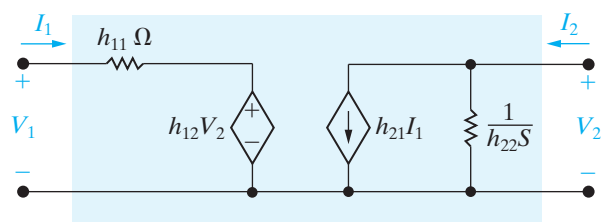
Figure P18.40



### Sections 18.1–18.4

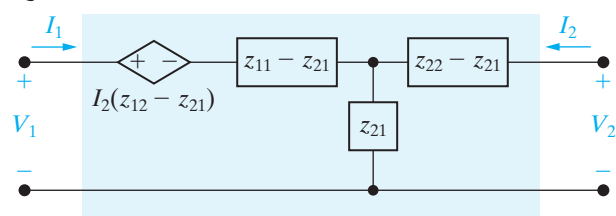
- 18.41** a) Show that the circuit in Fig. P18.41 is an equivalent circuit satisfied by the  $h$ -parameter equations.  
 b) Use the  $h$ -parameter equivalent circuit of (a) to find the voltage gain  $V_2/V_g$  in the circuit in Fig. 18.11.

Figure P18.41



- 18.42** a) Show that the circuit in Fig. P18.42 is an equivalent circuit satisfied by the  $z$ -parameter equations.  
 b) Assume that the equivalent circuit in Fig. P18.42 is driven by a voltage source having an internal impedance of  $Z_g$  ohms. Calculate the Thévenin equivalent circuit with respect to port 2. Check your results against the appropriate entries in Table 18.2.

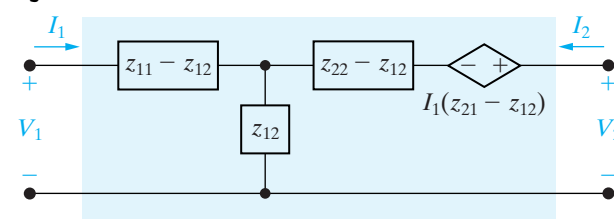
Figure P18.42



- 18.43** a) Show that the circuit in Fig. P18.43 is also an equivalent circuit satisfied by the  $z$ -parameter equations.

- Assume that the equivalent circuit in Fig. P18.43 is terminated in an impedance of  $Z_L$  ohms at port 2. Find the input impedance  $V_1/I_1$ . Check your results against the appropriate entry in Table 18.2.

Figure P18.43



- 18.44** a) Derive two equivalent circuits that are satisfied by the  $y$ -parameter equations. *Hint:* Start with Eqs. 18.2. Add and subtract  $y_{21}V_2$  to the first equation of the set. Construct a circuit that satisfies the resulting set of equations, by thinking in terms of node voltages. Derive an alternative equivalent circuit by first altering the second equation in Eq. 18.2.

- Assume that port 1 is driven by a voltage source having an internal impedance  $Z_g$ , and port 2 is loaded with an impedance  $Z_L$ . Find the current gain  $I_2/I_1$ . Check your results against the appropriate entry in Table 18.2.

- 18.45** a) Derive the equivalent circuit satisfied by the  $g$ -parameter equations.

- Use the  $g$ -parameter equivalent circuit derived in part (a) to solve for the output voltage in Problem 18.39. *Hint:* Use Problem 3.67 to simplify the second two-port circuit in Problem 18.39.

- 18.46** a) What conditions and measurements will allow you to calculate the  $b$  parameters for the “black box” amplifier described in the Practical Perspective?

- What measurements will be made if the resulting  $b$  parameters are equivalent to the  $h$  parameters calculated in the Practical Perspective?

- 18.47** Repeat Problem 18.46 for the  $y$  parameters.

*This page intentionally left blank*



# Appendix A The Solution of Linear Simultaneous Equations

Circuit analysis frequently involves the solution of linear simultaneous equations. Our purpose here is to review the use of determinants to solve such a set of equations. The theory of determinants (with applications) can be found in most intermediate-level algebra texts. (A particularly good reference for engineering students is Chapter 1 of E.A. Guillemin's *The Mathematics of Circuit Analysis* [New York: Wiley, 1949]. In our review here, we will limit our discussion to the mechanics of solving simultaneous equations with determinants.

## A.1 Preliminary Steps

The first step in solving a set of simultaneous equations by determinants is to write the equations in a rectangular (square) format. In other words, we arrange the equations in a vertical stack such that each variable occupies the same horizontal position in every equation. For example, in Eqs. A.1, the variables  $i_1$ ,  $i_2$ , and  $i_3$  occupy the first, second, and third position, respectively, on the left-hand side of each equation:

$$\begin{aligned}21i_1 - 9i_2 - 12i_3 &= -33, \\ -3i_1 + 6i_2 - 2i_3 &= 3, \\ -8i_1 - 4i_2 + 22i_3 &= 50.\end{aligned}\tag{A.1}$$

Alternatively, one can describe this set of equations by saying that  $i_1$  occupies the first column in the array,  $i_2$  the second column, and  $i_3$  the third column.

If one or more variables are missing from a given equation, they can be inserted by simply making their coefficient zero. Thus Eqs. A.2 can be “squared up” as shown by Eqs. A.3:

$$\begin{aligned}2v_1 - v_2 &= 4, \\ 4v_2 + 3v_3 &= 16, \\ 7v_1 + 2v_3 &= 5;\end{aligned}\tag{A.2}$$

$$\begin{aligned}2v_1 - v_2 + 0v_3 &= 4, \\ 0v_1 + 4v_2 + 3v_3 &= 16, \\ 7v_1 + 0v_2 + 2v_3 &= 5.\end{aligned}\tag{A.3}$$

## A.2 Cramer's Method

The value of each unknown variable in the set of equations is expressed as the ratio of two determinants. If we let  $N_k$ , with an appropriate subscript, represent the numerator determinant and  $\Delta$  represent the denominator determinant, then the  $k$ th unknown  $x_k$  is

$$x_k = \frac{N_k}{\Delta}. \quad (\text{A.4})$$

The denominator determinant  $\Delta$  is the same for every unknown variable and is called the **characteristic determinant** of the set of equations. The numerator determinant  $N_k$  varies with each unknown. Equation A.4 is referred to as **Cramer's method** for solving simultaneous equations.

## A.3 The Characteristic Determinant

Once we have organized the set of simultaneous equations into an ordered array, as illustrated by Eqs. A.1 and A.3, it is a simple matter to form the characteristic determinant. This determinant is the square array made up from the coefficients of the unknown variables. For example, the characteristic determinants of Eqs. A.1 and A.3 are

$$\Delta = \begin{vmatrix} 21 & -9 & -12 \\ -3 & 6 & -2 \\ -8 & -4 & 22 \end{vmatrix} \quad (\text{A.5})$$

and

$$\Delta = \begin{vmatrix} 2 & -1 & 0 \\ 0 & 4 & 3 \\ 7 & 0 & 2 \end{vmatrix}, \quad (\text{A.6})$$

respectively.

## A.4 The Numerator Determinant

The numerator determinant  $N_k$  is formed from the characteristic determinant by replacing the  $k$ th column in the characteristic determinant with the column of values appearing on the right-hand side of the equations. For example, the numerator determinants for evaluating  $i_1$ ,  $i_2$ , and  $i_3$  in Eqs. A.1 are

$$N_1 = \begin{vmatrix} -33 & -9 & -12 \\ 3 & 6 & -2 \\ 50 & -4 & 22 \end{vmatrix}, \quad (\text{A.7})$$

$$N_2 = \begin{vmatrix} 21 & -33 & -12 \\ -3 & 3 & -2 \\ -8 & 50 & 22 \end{vmatrix}, \quad (\text{A.8})$$

and

$$N_3 = \begin{vmatrix} 21 & -9 & -33 \\ -3 & 6 & 3 \\ -8 & -4 & 50 \end{vmatrix}. \quad (\text{A.9})$$

The numerator determinants for the evaluation of  $v_1$ ,  $v_2$ , and  $v_3$  in Eqs. A.3 are

$$N_1 = \begin{vmatrix} 4 & -1 & 0 \\ 16 & 4 & 3 \\ 5 & 0 & 2 \end{vmatrix}, \quad (\text{A.10})$$

$$N_2 = \begin{vmatrix} 2 & 4 & 0 \\ 0 & 16 & 3 \\ 7 & 5 & 2 \end{vmatrix}, \quad (\text{A.11})$$

and

$$N_3 = \begin{vmatrix} 2 & -1 & 4 \\ 0 & 4 & 16 \\ 7 & 0 & 5 \end{vmatrix}. \quad (\text{A.12})$$

## A.5 The Evaluation of a Determinant

The value of a determinant is found by expanding it in terms of its minors. The **minor** of any element in a determinant is the determinant that remains after the row and column occupied by the element have been deleted. For example, the minor of the element 6 in Eq. A.7 is

$$\begin{vmatrix} -33 & -12 \\ 50 & 22 \end{vmatrix},$$

while the minor of the element 22 in Eq. A.7 is

$$\begin{vmatrix} -33 & -9 \\ 3 & 6 \end{vmatrix}.$$

The **cofactor** of an element is its minor multiplied by the sign-controlling factor

$$-1^{(i+j)},$$

where  $i$  and  $j$  denote the row and column, respectively, occupied by the element. Thus the cofactor of the element 6 in Eq. A.7 is

$$-1^{(2+2)} \begin{vmatrix} -33 & -12 \\ 50 & 22 \end{vmatrix},$$

and the cofactor of the element 22 is

$$-1^{(3+3)} \begin{vmatrix} -33 & -9 \\ 3 & 6 \end{vmatrix}.$$

The cofactor of an element is also referred to as its **signed minor**.

The sign-controlling factor  $-1^{(i+j)}$  will equal +1 or -1 depending on whether  $i + j$  is an even or odd integer. Thus the algebraic sign of a cofactor alternates between +1 and -1 as we move along a row or column. For a  $3 \times 3$  determinant, the plus and minus signs form the checkerboard pattern illustrated here:

$$\begin{vmatrix} + & - & + \\ - & + & - \\ + & - & + \end{vmatrix}$$

A determinant can be expanded along any row or column. Thus the first step in making an expansion is to select a row  $i$  or a column  $j$ . Once a row or column has been selected, each element in that row or column is multiplied by its signed minor, or cofactor. The value of the determinant is the sum of these products. As an example, let us evaluate the determinant in Eq. A.5 by expanding it along its first column. Following the rules just explained, we write the expansion as

$$\Delta = 21(1) \begin{vmatrix} 6 & -2 \\ -4 & 22 \end{vmatrix} - 3(-1) \begin{vmatrix} -9 & -12 \\ -4 & 22 \end{vmatrix} - 8(1) \begin{vmatrix} -9 & -12 \\ 6 & -2 \end{vmatrix} \quad (\text{A.13})$$

The  $2 \times 2$  determinants in Eq. A.13 can also be expanded by minors. The minor of an element in a  $2 \times 2$  determinant is a single element. It follows that the expansion reduces to multiplying the upper-left element by the lower-right element and then subtracting from this product the product of the lower-left element times the upper-right element. Using this observation, we evaluate Eq. A.13 to

$$\begin{aligned} \Delta &= 21(132 - 8) + 3(-198 - 48) - 8(18 + 72) \\ &= 2604 - 738 - 720 = 1146. \end{aligned} \quad (\text{A.14})$$

Had we elected to expand the determinant along the second row of elements, we would have written

$$\begin{aligned} \Delta &= -3(-1) \begin{vmatrix} -9 & -12 \\ -4 & 22 \end{vmatrix} + 6(+1) \begin{vmatrix} 21 & -12 \\ -8 & 22 \end{vmatrix} - 2(-1) \begin{vmatrix} 21 & -9 \\ -8 & -4 \end{vmatrix} \\ &= 3(-198 - 48) + 6(462 - 96) + 2(-84 - 72) \\ &= -738 + 2196 - 312 = 1146. \end{aligned} \quad (\text{A.15})$$

The numerical values of the determinants  $N_1$ ,  $N_2$ , and  $N_3$  given by Eqs. A.7, A.8, and A.9 are

$$N_1 = 1146, \quad (\text{A.16})$$

$$N_2 = 2292, \quad (\text{A.17})$$

and

$$N_3 = 3438. \quad (\text{A.18})$$

It follows from Eqs. A.15 through A.18 that the solutions for  $i_1$ ,  $i_2$ , and  $i_3$  in Eq. A.1 are

$$i_1 = \frac{N_1}{\Delta} = 1 \text{ A},$$

$$i_2 = \frac{N_2}{\Delta} = 2 \text{ A}, \quad (\text{A.19})$$

and

$$i_3 = \frac{N_3}{\Delta} = 3 \text{ A}.$$

We leave you to verify that the solutions for  $v_1$ ,  $v_2$ , and  $v_3$  in Eqs. A.3 are

$$v_1 = \frac{49}{-5} = -9.8 \text{ V},$$

$$v_2 = \frac{118}{-5} = -23.6 \text{ V}, \quad (\text{A.20})$$

and

$$v_3 = \frac{-184}{-5} = 36.8 \text{ V}.$$

## A.6 Matrices

A system of simultaneous linear equations can also be solved using matrices. In what follows, we briefly review matrix notation, algebra, and terminology.<sup>1</sup>

A **matrix** is by definition a rectangular array of elements; thus

$$\mathbf{A} = \begin{bmatrix} a_{11} & a_{12} & a_{13} & \cdots & a_{1n} \\ a_{21} & a_{22} & a_{23} & \cdots & a_{2n} \\ \cdots & \cdots & \cdots & \cdots & \cdots \\ a_{m1} & a_{m2} & a_{m3} & \cdots & a_{mn} \end{bmatrix} \quad (\text{A.21})$$

is a matrix with  $m$  rows and  $n$  columns. We describe  $A$  as being a matrix of order  $m$  by  $n$ , or  $m \times n$ , where  $m$  equals the number of rows and  $n$  the

<sup>1</sup> An excellent introductory-level text in matrix applications to circuit analysis is Lawrence P. Huelsman, *Circuits, Matrices, and Linear Vector Spaces* (New York: McGraw-Hill, 1963).



number of columns. We always specify the rows first and the columns second. The elements of the matrix— $a_{11}, a_{12}, a_{13}, \dots$ —can be real numbers, complex numbers, or functions. We denote a matrix with a boldface capital letter.

The array in Eq. A.21 is frequently abbreviated by writing

$$\mathbf{A} = [a_{ij}]_{mn}, \quad (\text{A.22})$$

where  $a_{ij}$  is the element in the  $i$ th row and the  $j$ th column.

If  $m = 1$ ,  $\mathbf{A}$  is called a **row matrix**, that is,

$$\mathbf{A} = [a_{11} \quad a_{12} \quad a_{13} \quad \cdots \quad a_{1n}]. \quad (\text{A.23})$$

If  $n = 1$ ,  $\mathbf{A}$  is called a **column matrix**, that is,

$$\mathbf{A} = \begin{bmatrix} a_{11} \\ a_{21} \\ a_{31} \\ \vdots \\ a_{m1} \end{bmatrix}. \quad (\text{A.24})$$

If  $m = n$ ,  $\mathbf{A}$  is called a **square matrix**. For example, if  $m = n = 3$ , the square 3 by 3 matrix is

$$\mathbf{A} = \begin{bmatrix} a_{11} & a_{12} & a_{13} \\ a_{21} & a_{22} & a_{23} \\ a_{31} & a_{32} & a_{33} \end{bmatrix}. \quad (\text{A.25})$$

Also note that we use brackets  $[\ ]$  to denote a matrix, whereas we use vertical lines  $|\ |$  to denote a determinant. It is important to know the difference. A matrix is a rectangular array of elements. A **determinant** is a function of a square array of elements. Thus if a matrix  $\mathbf{A}$  is square, we can define the determinant of  $\mathbf{A}$ . For example, if

$$\mathbf{A} = \begin{bmatrix} 2 & 1 \\ 6 & 15 \end{bmatrix},$$

then

$$\det \mathbf{A} = \begin{vmatrix} 2 & 1 \\ 6 & 15 \end{vmatrix} = 30 - 6 = 24.$$

## A.7 Matrix Algebra

The equality, addition, and subtraction of matrices apply only to matrices of the same order. Two matrices are equal if, and only if, their corresponding elements are equal. In other words,  $\mathbf{A} = \mathbf{B}$  if, and only if,  $a_{ij} = b_{ij}$  for all  $i$  and  $j$ . For example, the two matrices in Eqs. A.26 and A.27 are equal because  $a_{11} = b_{11}$ ,  $a_{12} = b_{12}$ ,  $a_{21} = b_{21}$ , and  $a_{22} = b_{22}$ :

$$\mathbf{A} = \begin{bmatrix} 36 & -20 \\ 4 & 16 \end{bmatrix}, \quad (\text{A.26})$$

$$\mathbf{B} = \begin{bmatrix} 36 & -20 \\ 4 & 16 \end{bmatrix}. \quad (\text{A.27})$$

If  $\mathbf{A}$  and  $\mathbf{B}$  are of the same order, then

$$\mathbf{C} = \mathbf{A} + \mathbf{B} \quad (\text{A.28})$$

implies

$$c_{ij} = a_{ij} + b_{ij}. \quad (\text{A.29})$$

For example, if

$$\mathbf{A} = \begin{bmatrix} 4 & -6 & 10 \\ 8 & 12 & -4 \end{bmatrix}, \quad (\text{A.30})$$

and

$$\mathbf{B} = \begin{bmatrix} 16 & 10 & -30 \\ -20 & 8 & 15 \end{bmatrix}, \quad (\text{A.31})$$

then

$$\mathbf{C} = \begin{bmatrix} 20 & 4 & -20 \\ -12 & 20 & 11 \end{bmatrix}. \quad (\text{A.32})$$

The equation

$$\mathbf{D} = \mathbf{A} - \mathbf{B} \quad (\text{A.33})$$

implies

$$d_{ij} = a_{ij} - b_{ij}. \quad (\text{A.34})$$

For the matrices in Eqs. A.30 and A.31, we would have

$$\mathbf{D} = \begin{bmatrix} -12 & -16 & 40 \\ 28 & 4 & -19 \end{bmatrix}. \quad (\text{A.35})$$

Matrices of the same order are said to be **conformable** for addition and subtraction.

Multiplying a matrix by a scalar  $k$  is equivalent to multiplying each element by the scalar. Thus  $\mathbf{A} = k\mathbf{B}$  if, and only if,  $a_{ij} = kb_{ij}$ . It should be noted that  $k$  may be real or complex. As an example, we will multiply the matrix  $\mathbf{D}$  in Eq. A.35 by 5. The result is

$$5\mathbf{D} = \begin{bmatrix} -60 & -80 & 200 \\ 140 & 20 & -95 \end{bmatrix}. \quad (\text{A.36})$$

Matrix multiplication can be performed only if the number of columns in the first matrix is equal to the number of rows in the second matrix. In other words, the product  $\mathbf{AB}$  requires the number of columns in  $\mathbf{A}$  to equal the number of rows in  $\mathbf{B}$ . The order of the resulting matrix will

be the number of rows in  $\mathbf{A}$  by the number of columns in  $\mathbf{B}$ . Thus if  $\mathbf{C} = \mathbf{AB}$ , where  $\mathbf{A}$  is of order  $m \times p$  and  $\mathbf{B}$  is of order  $p \times n$ , then  $\mathbf{C}$  will be a matrix of order  $m \times n$ . When the number of columns in  $\mathbf{A}$  equals the number of rows in  $\mathbf{B}$ , we say  $\mathbf{A}$  is conformable to  $\mathbf{B}$  for multiplication.

An element in  $\mathbf{C}$  is given by the formula

$$c_{ij} = \sum_{k=1}^p a_{ik}b_{kj}. \quad (\text{A.37})$$

The formula given by Eq. A.37 is easy to use if one remembers that matrix multiplication is a row-by-column operation. Hence to get the  $i$ th,  $j$ th term in  $\mathbf{C}$ , each element in the  $i$ th row of  $\mathbf{A}$  is multiplied by the corresponding element in the  $j$ th column of  $\mathbf{B}$ , and the resulting products are summed. The following example illustrates the procedure. We are asked to find the matrix  $\mathbf{C}$  when

$$\mathbf{A} = \begin{bmatrix} 6 & 3 & 2 \\ 1 & 4 & 6 \end{bmatrix} \quad (\text{A.38})$$

and

$$\mathbf{B} = \begin{bmatrix} 4 & 2 \\ 0 & 3 \\ 1 & -2 \end{bmatrix}. \quad (\text{A.39})$$

First we note that  $\mathbf{C}$  will be a  $2 \times 2$  matrix and that each element in  $\mathbf{C}$  will require summing three products.

To find  $C_{11}$  we multiply the corresponding elements in row 1 of matrix  $\mathbf{A}$  with the elements in column 1 of matrix  $\mathbf{B}$  and then sum the products. We can visualize this multiplication and summing process by extracting the corresponding row and column from each matrix and then lining them up element by element. So to find  $C_{11}$  we have

$$\begin{array}{l} \text{Row 1 of } \mathbf{A} \\ \text{Column 1 of } \mathbf{B} \end{array} \begin{array}{c} 6 \quad | \quad 3 \quad | \quad 2 \\ 4 \quad | \quad 0 \quad | \quad 1 \end{array};$$

therefore

$$C_{11} = 6 \times 4 + 3 \times 0 + 2 \times 1 = 26.$$

To find  $C_{12}$  we visualize

$$\begin{array}{l} \text{Row 1 of } \mathbf{A} \\ \text{Column 2 of } \mathbf{B} \end{array} \begin{array}{c} 6 \quad | \quad 3 \quad | \quad 2 \\ 2 \quad | \quad 3 \quad | \quad -2 \end{array};$$

thus

$$C_{12} = 6 \times 2 + 3 \times 3 + 2 \times (-2) = 17.$$

For  $C_{21}$  we have

$$\begin{array}{l} \text{Row 2 of } \mathbf{A} \\ \text{Column 1 of } \mathbf{B} \end{array} \begin{array}{c} 1 \quad | \quad 4 \quad | \quad 6 \\ 4 \quad | \quad 0 \quad | \quad 1 \end{array};$$

and

$$C_{21} = 1 \times 4 + 4 \times 0 + 6 \times 1 = 10.$$

Finally, for  $C_{22}$  we have

$$\begin{array}{l} \text{Row 2 of } \mathbf{A} \\ \text{Column 2 of } \mathbf{B} \end{array} \begin{array}{c|c|c} 1 & 4 & 6 \\ \hline 2 & 3 & -2 \end{array};$$

from which

$$C_{22} = 1 \times 2 + 4 \times 3 + 6 \times (-2) = 2.$$

It follows that

$$\mathbf{C} = \mathbf{AB} = \begin{bmatrix} 26 & 17 \\ 10 & 2 \end{bmatrix}. \quad (\text{A.40})$$

In general, matrix multiplication is not commutative, that is,  $\mathbf{AB} \neq \mathbf{BA}$ . As an example, consider the product  $\mathbf{BA}$  for the matrices in Eqs. A.38 and A.39. The matrix generated by this multiplication is of order  $3 \times 3$ , and each term in the resulting matrix requires adding two products. Therefore if  $\mathbf{D} = \mathbf{BA}$ , we have

$$\mathbf{D} = \begin{bmatrix} 26 & 20 & 20 \\ 3 & 12 & 18 \\ 4 & -5 & -10 \end{bmatrix}. \quad (\text{A.41})$$

Obviously,  $\mathbf{C} \neq \mathbf{D}$ . We leave you to verify the elements in Eq. A.41.

Matrix multiplication is associative and distributive. Thus

$$(\mathbf{AB})\mathbf{C} = \mathbf{A}(\mathbf{BC}), \quad (\text{A.42})$$

$$\mathbf{A}(\mathbf{B} + \mathbf{C}) = \mathbf{AB} + \mathbf{AC}, \quad (\text{A.43})$$

and

$$(\mathbf{A} + \mathbf{B})\mathbf{C} = \mathbf{AC} + \mathbf{BC}. \quad (\text{A.44})$$

In Eqs. A.42, A.43, and A.44, we assume that the matrices are conformable for addition and multiplication.

We have already noted that matrix multiplication is not commutative. There are two other properties of multiplication in scalar algebra that do not carry over to matrix algebra.

First, the matrix product  $\mathbf{AB} = 0$  does not imply either  $\mathbf{A} = 0$  or  $\mathbf{B} = 0$ . (*Note:* A matrix is equal to zero when all its elements are zero.) For example, if

$$\mathbf{A} = \begin{bmatrix} 1 & 0 \\ 2 & 0 \end{bmatrix} \quad \text{and} \quad \mathbf{B} = \begin{bmatrix} 0 & 0 \\ 4 & 8 \end{bmatrix},$$

then

$$\mathbf{AB} = \begin{bmatrix} 0 & 0 \\ 0 & 0 \end{bmatrix} = 0.$$

Hence the product is zero, but neither  $\mathbf{A}$  nor  $\mathbf{B}$  is zero.

Second, the matrix equation  $\mathbf{AB} = \mathbf{AC}$  does not imply  $\mathbf{B} = \mathbf{C}$ . For example, if

$$\mathbf{A} = \begin{bmatrix} 1 & 0 \\ 2 & 0 \end{bmatrix}, \quad \mathbf{B} = \begin{bmatrix} 3 & 4 \\ 7 & 8 \end{bmatrix}, \quad \text{and} \quad \mathbf{C} = \begin{bmatrix} 3 & 4 \\ 5 & 6 \end{bmatrix},$$

then

$$\mathbf{AB} = \mathbf{AC} = \begin{bmatrix} 3 & 4 \\ 6 & 8 \end{bmatrix}, \quad \text{but} \quad \mathbf{B} \neq \mathbf{C}.$$

The **transpose** of a matrix is formed by interchanging the rows and columns. For example, if

$$\mathbf{A} = \begin{bmatrix} 1 & 2 & 3 \\ 4 & 5 & 6 \\ 7 & 8 & 9 \end{bmatrix}, \quad \text{then} \quad \mathbf{A}^T = \begin{bmatrix} 1 & 4 & 7 \\ 2 & 5 & 8 \\ 3 & 6 & 9 \end{bmatrix}.$$

The transpose of the sum of two matrices is equal to the sum of the transposes, that is,

$$(\mathbf{A} + \mathbf{B})^T = \mathbf{A}^T + \mathbf{B}^T. \quad (\text{A.45})$$

The transpose of the product of two matrices is equal to the product of the transposes taken in reverse order. In other words,

$$[\mathbf{AB}]^T = \mathbf{B}^T \mathbf{A}^T. \quad (\text{A.46})$$

Equation A.46 can be extended to a product of any number of matrices. For example,

$$[\mathbf{ABCD}]^T = \mathbf{D}^T \mathbf{C}^T \mathbf{B}^T \mathbf{A}^T. \quad (\text{A.47})$$

If  $\mathbf{A} = \mathbf{A}^T$ , the matrix is said to be **symmetric**. Only square matrices can be symmetric.

## A.8 Identity, Adjoint, and Inverse Matrices

An **identity matrix** is a square matrix where  $a_{ij} = 0$  for  $i \neq j$ , and  $a_{ij} = 1$  for  $i = j$ . In other words, all the elements in an identity matrix are zero except those along the main diagonal, where they are equal to 1. Thus

$$\begin{bmatrix} 1 & 0 \\ 0 & 1 \end{bmatrix}, \quad \begin{bmatrix} 1 & 0 & 0 \\ 0 & 1 & 0 \\ 0 & 0 & 1 \end{bmatrix}, \quad \text{and} \quad \begin{bmatrix} 1 & 0 & 0 & 0 \\ 0 & 1 & 0 & 0 \\ 0 & 0 & 1 & 0 \\ 0 & 0 & 0 & 1 \end{bmatrix}$$

are all identity matrices. Note that identity matrices are always square. We will use the symbol  $\mathbf{U}$  for an identity matrix.

The **adjoint** of a matrix  $\mathbf{A}$  of order  $n \times n$  is defined as

$$\text{adj } \mathbf{A} = [\Delta_{ji}]_{n \times n}, \quad (\text{A.48})$$

where  $\Delta_{ij}$  is the cofactor of  $a_{ij}$ . (See Section A.5 for the definition of a cofactor.) It follows from Eq. A.48 that one can think of finding the adjoint of a square matrix as a two-step process. First construct a matrix made up of the cofactors of  $\mathbf{A}$ , and then transpose the matrix of cofactors. As an example we will find the adjoint of the  $3 \times 3$  matrix

$$\mathbf{A} = \begin{bmatrix} 1 & 2 & 3 \\ 3 & 2 & 1 \\ -1 & 1 & 5 \end{bmatrix}.$$

The cofactors of the elements in  $\mathbf{A}$  are

$$\begin{aligned} \Delta_{11} &= 1(10 - 1) = 9, \\ \Delta_{12} &= -1(15 + 1) = -16, \\ \Delta_{13} &= 1(3 + 2) = 5, \\ \Delta_{21} &= -1(10 - 3) = -7, \\ \Delta_{22} &= 1(5 + 3) = 8, \\ \Delta_{23} &= -1(1 + 2) = -3, \\ \Delta_{31} &= 1(2 - 6) = -4, \\ \Delta_{32} &= -1(1 - 9) = 8, \\ \Delta_{33} &= 1(2 - 6) = -4. \end{aligned}$$

The matrix of cofactors is

$$\mathbf{B} = \begin{bmatrix} 9 & -16 & 5 \\ -7 & 8 & -3 \\ -4 & 8 & -4 \end{bmatrix}.$$

It follows that the adjoint of  $\mathbf{A}$  is

$$\text{adj } \mathbf{A} = \mathbf{B}^T = \begin{bmatrix} 9 & -7 & -4 \\ -16 & 8 & 8 \\ 5 & -3 & -4 \end{bmatrix}.$$

One can check the arithmetic of finding the adjoint of a matrix by using the theorem

$$\text{adj } \mathbf{A} \cdot \mathbf{A} = \det \mathbf{A} \cdot \mathbf{U}. \quad (\text{A.49})$$

Equation A.49 tells us that the adjoint of  $\mathbf{A}$  times  $\mathbf{A}$  equals the determinant of  $\mathbf{A}$  times the identity matrix, or for our example,

$$\det \mathbf{A} = 1(9) + 3(-7) - 1(-4) = -8.$$

If we let  $\mathbf{C} = \text{adj } \mathbf{A} \cdot \mathbf{A}$  and use the technique illustrated in Section A.7, we find the elements of  $\mathbf{C}$  to be

$$\begin{aligned} c_{11} &= 9 - 21 + 4 = -8, \\ c_{12} &= 18 - 14 - 4 = 0, \\ c_{13} &= 27 - 7 - 20 = 0, \\ c_{21} &= -16 + 24 - 8 = 0, \\ c_{22} &= -32 + 16 + 8 = -8, \\ c_{23} &= -48 + 8 + 40 = 0, \\ c_{31} &= 5 - 9 + 4 = 0, \\ c_{32} &= 10 - 6 - 4 = 0, \\ c_{33} &= 15 - 3 - 20 = -8. \end{aligned}$$

Therefore

$$\begin{aligned} \mathbf{C} &= \begin{bmatrix} -8 & 0 & 0 \\ 0 & -8 & 0 \\ 0 & 0 & -8 \end{bmatrix} = -8 \begin{bmatrix} 1 & 0 & 0 \\ 0 & 1 & 0 \\ 0 & 0 & 1 \end{bmatrix} \\ &= \det \mathbf{A} \cdot \mathbf{U}. \end{aligned}$$

A square matrix  $\mathbf{A}$  has an **inverse**, denoted as  $\mathbf{A}^{-1}$ , if

$$\mathbf{A}^{-1}\mathbf{A} = \mathbf{A}\mathbf{A}^{-1} = \mathbf{U}. \quad (\text{A.50})$$

Equation A.50 tells us that a matrix either premultiplied or postmultiplied by its inverse generates the identity matrix  $\mathbf{U}$ . For the inverse matrix to exist, it is necessary that the determinant of  $\mathbf{A}$  not equal zero. Only square matrices have inverses, and the inverse is also square.

A formula for finding the inverse of a matrix is

$$\mathbf{A}^{-1} = \frac{\text{adj } \mathbf{A}}{\det \mathbf{A}}. \quad (\text{A.51})$$

The formula in Eq. A.51 becomes very cumbersome if  $\mathbf{A}$  is of an order larger than 3 by 3.<sup>2</sup> Today the digital computer eliminates the drudgery of having to find the inverse of a matrix in numerical applications of matrix algebra.

It follows from Eq. A.51 that the inverse of the matrix  $\mathbf{A}$  in the previous example is

$$\begin{aligned} \mathbf{A}^{-1} &= -1/8 \begin{bmatrix} 9 & -7 & -4 \\ -16 & 8 & 8 \\ 5 & -3 & -4 \end{bmatrix} \\ &= \begin{bmatrix} -1.125 & 0.875 & 0.5 \\ 2 & -1 & -1 \\ -0.625 & 0.375 & 0.5 \end{bmatrix}. \end{aligned}$$

You should verify that  $\mathbf{A}^{-1}\mathbf{A} = \mathbf{A}\mathbf{A}^{-1} = \mathbf{U}$ .

<sup>2</sup> You can learn alternative methods for finding the inverse in any introductory text on matrix theory. See, for example, Franz E. Hohn, *Elementary Matrix Algebra* (New York: Macmillan, 1973).

## A.9 Partitioned Matrices

It is often convenient in matrix manipulations to partition a given matrix into submatrices. The original algebraic operations are then carried out in terms of the submatrices. In partitioning a matrix, the placement of the partitions is completely arbitrary, with the one restriction that a partition must dissect the entire matrix. In selecting the partitions, it is also necessary to make sure the submatrices are conformable to the mathematical operations in which they are involved.

For example, consider using submatrices to find the product  $\mathbf{C} = \mathbf{AB}$ , where

$$\mathbf{A} = \begin{bmatrix} 1 & 2 & 3 & 4 & 5 \\ 5 & 4 & 3 & 2 & 1 \\ -1 & 0 & 2 & -3 & 1 \\ 0 & 1 & -1 & 0 & 1 \\ 0 & 2 & 1 & -2 & 0 \end{bmatrix}$$

and

$$\mathbf{B} = \begin{bmatrix} 2 \\ 0 \\ -1 \\ 3 \\ 0 \end{bmatrix}.$$

Assume that we decide to partition  $\mathbf{B}$  into two submatrices,  $\mathbf{B}_{11}$  and  $\mathbf{B}_{21}$ ; thus

$$\mathbf{B} = \begin{bmatrix} \mathbf{B}_{11} \\ \mathbf{B}_{21} \end{bmatrix}.$$

Now since  $\mathbf{B}$  has been partitioned into a two-row column matrix,  $\mathbf{A}$  must be partitioned into at least a two-column matrix; otherwise the multiplication cannot be performed. The location of the vertical partitions of the  $\mathbf{A}$  matrix will depend on the definitions of  $\mathbf{B}_{11}$  and  $\mathbf{B}_{21}$ . For example, if

$$\mathbf{B}_{11} = \begin{bmatrix} 2 \\ 0 \\ -1 \end{bmatrix} \quad \text{and} \quad \mathbf{B}_{21} = \begin{bmatrix} 3 \\ 0 \end{bmatrix},$$

then  $\mathbf{A}_{11}$  must contain three columns, and  $\mathbf{A}_{12}$  must contain two columns. Thus the partitioning shown in Eq. A.52 would be acceptable for executing the product  $\mathbf{AB}$ :

$$\mathbf{C} = \begin{bmatrix} 1 & 2 & 3 & | & 4 & 5 \\ 5 & 4 & 3 & | & 2 & 1 \\ -1 & 0 & 2 & | & -3 & 1 \\ 0 & 1 & -1 & | & 0 & 1 \\ 0 & 2 & 1 & | & -2 & 0 \end{bmatrix} \begin{bmatrix} 2 \\ 0 \\ -1 \\ \dots \\ 3 \\ 0 \end{bmatrix}. \quad (\text{A.52})$$



If, on the other hand, we partition the  $\mathbf{B}$  matrix so that

$$\mathbf{B}_{11} = \begin{bmatrix} 2 \\ 0 \end{bmatrix} \quad \text{and} \quad \mathbf{B}_{21} = \begin{bmatrix} -1 \\ 3 \\ 0 \end{bmatrix},$$

then  $\mathbf{A}_{11}$  must contain two columns, and  $\mathbf{A}_{12}$  must contain three columns. In this case the partitioning shown in Eq. A.53 would be acceptable in executing the product  $\mathbf{C} = \mathbf{AB}$ :

$$\mathbf{C} = \left[ \begin{array}{cc|ccc} 1 & 2 & 3 & 4 & 5 \\ 5 & 4 & 3 & 2 & 1 \\ -1 & 0 & 2 & -3 & 1 \\ 0 & 1 & -1 & 0 & 1 \\ 0 & 2 & 1 & -2 & 0 \end{array} \right] \begin{bmatrix} 2 \\ 0 \\ \dots \\ -1 \\ 3 \\ 0 \end{bmatrix}. \quad (\text{A.53})$$

For purposes of discussion, we will focus on the partitioning given in Eq. A.52 and leave you to verify that the partitioning in Eq. A.53 leads to the same result.

From Eq. A.52 we can write

$$\mathbf{C} = [\mathbf{A}_{11} \quad \mathbf{A}_{12}] \begin{bmatrix} \mathbf{B}_{11} \\ \mathbf{B}_{21} \end{bmatrix} = \mathbf{A}_{11}\mathbf{B}_{11} + \mathbf{A}_{12}\mathbf{B}_{21}. \quad (\text{A.54})$$

It follows from Eqs. A.52 and A.54 that

$$\mathbf{A}_{11}\mathbf{B}_{11} = \begin{bmatrix} 1 & 2 & 3 \\ 5 & 4 & 3 \\ -1 & 0 & 2 \\ 0 & 1 & -1 \\ 0 & 2 & 1 \end{bmatrix} \begin{bmatrix} 2 \\ 0 \\ -1 \end{bmatrix} = \begin{bmatrix} -1 \\ 7 \\ -4 \\ 1 \\ -1 \end{bmatrix},$$

$$\mathbf{A}_{12}\mathbf{B}_{21} = \begin{bmatrix} 4 & 5 \\ 2 & 1 \\ -3 & 1 \\ 0 & 1 \\ -2 & 0 \end{bmatrix} \begin{bmatrix} 3 \\ 0 \end{bmatrix} = \begin{bmatrix} 12 \\ 6 \\ -9 \\ 0 \\ -6 \end{bmatrix},$$

and

$$\mathbf{C} = \begin{bmatrix} 11 \\ 13 \\ -13 \\ 1 \\ -7 \end{bmatrix}.$$

The  $\mathbf{A}$  matrix could also be partitioned horizontally once the vertical partitioning is made consistent with the multiplication operation. In this simple problem, the horizontal partitions can be made at the discretion of

the analyst. Therefore  $\mathbf{C}$  could also be evaluated using the partitioning shown in Eq. A.55:

$$\mathbf{C} = \begin{bmatrix} 1 & 2 & 3 & | & 4 & 5 \\ 5 & 4 & 3 & | & 2 & 1 \\ \cdots & \cdots & \cdots & \cdots & \cdots & \cdots \\ -1 & 0 & 2 & | & -3 & 1 \\ 0 & 1 & -1 & | & 0 & 1 \\ 0 & 2 & 1 & | & -2 & 0 \end{bmatrix} \begin{bmatrix} 2 \\ 0 \\ -1 \\ \cdots \\ 3 \\ 0 \end{bmatrix}. \quad (\text{A.55})$$

From Eq. A.55 it follows that

$$\mathbf{C} = \begin{bmatrix} \mathbf{A}_{11} & \mathbf{A}_{12} \\ \mathbf{A}_{21} & \mathbf{A}_{22} \end{bmatrix} \begin{bmatrix} \mathbf{B}_{11} \\ \mathbf{B}_{21} \end{bmatrix} = \begin{bmatrix} \mathbf{C}_{11} \\ \mathbf{C}_{21} \end{bmatrix}, \quad (\text{A.56})$$

where

$$\begin{aligned} \mathbf{C}_{11} &= \mathbf{A}_{11}\mathbf{B}_{11} + \mathbf{A}_{12}\mathbf{B}_{21}, \\ \mathbf{C}_{21} &= \mathbf{A}_{21}\mathbf{B}_{11} + \mathbf{A}_{22}\mathbf{B}_{21}. \end{aligned}$$

You should verify that

$$\begin{aligned} \mathbf{C}_{11} &= \begin{bmatrix} 1 & 2 & 3 \\ 5 & 4 & 3 \end{bmatrix} \begin{bmatrix} 2 \\ 0 \\ -1 \end{bmatrix} + \begin{bmatrix} 4 & 5 \\ 2 & 1 \end{bmatrix} \begin{bmatrix} 3 \\ 0 \end{bmatrix} \\ &= \begin{bmatrix} -1 \\ 7 \end{bmatrix} + \begin{bmatrix} 12 \\ 6 \end{bmatrix} = \begin{bmatrix} 11 \\ 13 \end{bmatrix}, \\ \mathbf{C}_{21} &= \begin{bmatrix} -1 & 0 & 2 \\ 0 & 1 & -1 \\ 0 & 2 & 1 \end{bmatrix} \begin{bmatrix} 2 \\ 0 \\ -1 \end{bmatrix} + \begin{bmatrix} -3 & 1 \\ 0 & 1 \\ -2 & 0 \end{bmatrix} \begin{bmatrix} 3 \\ 0 \end{bmatrix} \\ &= \begin{bmatrix} -4 \\ 1 \\ -1 \end{bmatrix} + \begin{bmatrix} -9 \\ 0 \\ -6 \end{bmatrix} = \begin{bmatrix} -13 \\ 1 \\ -7 \end{bmatrix}, \end{aligned}$$

and

$$\mathbf{C} = \begin{bmatrix} 11 \\ 13 \\ -13 \\ 1 \\ -7 \end{bmatrix}.$$

We note in passing that the partitioning in Eqs. A.52 and A.55 is conformable with respect to addition.

## A.10 Applications

The following examples demonstrate some applications of matrix algebra in circuit analysis.

### Example A.1

Use the matrix method to solve for the node voltages  $v_1$  and  $v_2$  in Eqs. 4.5 and 4.6.

#### Solution

The first step is to rewrite Eqs. 4.5 and 4.6 in matrix notation. Collecting the coefficients of  $v_1$  and  $v_2$  and at the same time shifting the constant terms to the right-hand side of the equations gives us

$$\begin{aligned} 1.7v_1 - 0.5v_2 &= 10, \\ -0.5v_1 + 0.6v_2 &= 2. \end{aligned} \quad (\text{A.57})$$

It follows that in matrix notation, Eq. A.57 becomes

$$\begin{bmatrix} 1.7 & -0.5 \\ -0.5 & 0.6 \end{bmatrix} \begin{bmatrix} v_1 \\ v_2 \end{bmatrix} = \begin{bmatrix} 10 \\ 2 \end{bmatrix}, \quad (\text{A.58})$$

or

$$\mathbf{A}\mathbf{V} = \mathbf{I}, \quad (\text{A.59})$$

where

$$\mathbf{A} = \begin{bmatrix} 1.7 & -0.5 \\ -0.5 & 0.6 \end{bmatrix},$$

$$\mathbf{V} = \begin{bmatrix} v_1 \\ v_2 \end{bmatrix},$$

$$\mathbf{I} = \begin{bmatrix} 10 \\ 2 \end{bmatrix}.$$

To find the elements of the  $\mathbf{V}$  matrix, we pre-multiply both sides of Eq. A.59 by the inverse of  $\mathbf{A}$ ; thus

$$\mathbf{A}^{-1}\mathbf{A}\mathbf{V} = \mathbf{A}^{-1}\mathbf{I}. \quad (\text{A.60})$$

Equation A.60 reduces to

$$\mathbf{U}\mathbf{V} = \mathbf{A}^{-1}\mathbf{I}, \quad (\text{A.61})$$

or

$$\mathbf{V} = \mathbf{A}^{-1}\mathbf{I}. \quad (\text{A.62})$$

It follows from Eq. A.62 that the solutions for  $v_1$  and  $v_2$  are obtained by solving for the matrix product  $\mathbf{A}^{-1}\mathbf{I}$ .

To find the inverse of  $\mathbf{A}$ , we first find the cofactors of  $\mathbf{A}$ . Thus

$$\begin{aligned} \Delta_{11} &= (-1)^2(0.6) = 0.6, \\ \Delta_{12} &= (-1)^3(-0.5) = 0.5, \\ \Delta_{21} &= (-1)^3(-0.5) = 0.5, \\ \Delta_{22} &= (-1)^4(1.7) = 1.7. \end{aligned} \quad (\text{A.63})$$

The matrix of cofactors is

$$\mathbf{B} = \begin{bmatrix} 0.6 & 0.5 \\ 0.5 & 1.7 \end{bmatrix}, \quad (\text{A.64})$$

and the adjoint of  $\mathbf{A}$  is

$$\text{adj } \mathbf{A} = \mathbf{B}^T = \begin{bmatrix} 0.6 & 0.5 \\ 0.5 & 1.7 \end{bmatrix}. \quad (\text{A.65})$$

The determinant of  $\mathbf{A}$  is

$$\det \mathbf{A} = \begin{vmatrix} 1.7 & -0.5 \\ -0.5 & 0.6 \end{vmatrix} = (1.7)(0.6) - (0.25) = 0.77. \quad (\text{A.66})$$

From Eqs. A.65 and A.66, we can write the inverse of the coefficient matrix, that is,

$$\mathbf{A}^{-1} = \frac{1}{0.77} \begin{bmatrix} 0.6 & 0.5 \\ 0.5 & 1.7 \end{bmatrix}. \quad (\text{A.67})$$

Now the product  $\mathbf{A}^{-1}\mathbf{I}$  is found:

$$\begin{aligned} \mathbf{A}^{-1}\mathbf{I} &= \frac{100}{77} \begin{bmatrix} 0.6 & 0.5 \\ 0.5 & 1.7 \end{bmatrix} \begin{bmatrix} 10 \\ 2 \end{bmatrix} \\ &= \frac{100}{77} \begin{bmatrix} 7 \\ 8.4 \end{bmatrix} = \begin{bmatrix} 9.09 \\ 10.91 \end{bmatrix}. \end{aligned} \quad (\text{A.68})$$

It follows directly that

$$\begin{bmatrix} v_1 \\ v_2 \end{bmatrix} = \begin{bmatrix} 9.09 \\ 10.91 \end{bmatrix}, \quad (\text{A.69})$$

or  $v_1 = 9.09$  V and  $v_2 = 10.91$  V.

**Example A.2**

Use the matrix method to find the three mesh currents in the circuit in Fig. 4.24.

**Solution**

The mesh-current equations that describe the circuit in Fig. 4.24 are given in Eq. 4.34. The constraint equation imposed by the current-controlled voltage source is given in Eq. 4.35. When Eq. 4.35 is substituted into Eq. 4.34, the following set of equations evolves:

$$\begin{aligned} 25i_1 - 5i_2 - 20i_3 &= 50, \\ -5i_1 + 10i_2 - 4i_3 &= 0, \\ -5i_1 - 4i_2 + 9i_3 &= 0. \end{aligned} \quad (\text{A.70})$$

In matrix notation, Eqs. A.70 reduce to

$$\mathbf{A}\mathbf{I} = \mathbf{V}, \quad (\text{A.71})$$

where

$$\mathbf{A} = \begin{bmatrix} 25 & -5 & -20 \\ -5 & 10 & -4 \\ -5 & -4 & 9 \end{bmatrix},$$

$$\mathbf{I} = \begin{bmatrix} i_1 \\ i_2 \\ i_3 \end{bmatrix},$$

and

$$\mathbf{V} = \begin{bmatrix} 50 \\ 0 \\ 0 \end{bmatrix}.$$

It follows from Eq. A.71 that the solution for  $\mathbf{I}$  is

$$\mathbf{I} = \mathbf{A}^{-1}\mathbf{V}. \quad (\text{A.72})$$

We find the inverse of  $\mathbf{A}$  by using the relationship

$$\mathbf{A}^{-1} = \frac{\text{adj } \mathbf{A}}{\det \mathbf{A}}. \quad (\text{A.73})$$

To find the adjoint of  $\mathbf{A}$ , we first calculate the cofactors of  $\mathbf{A}$ . Thus

$$\begin{aligned} \Delta_{11} &= (-1)^2(90 - 16) = 74, \\ \Delta_{12} &= (-1)^3(-45 - 20) = 65, \\ \Delta_{13} &= (-1)^4(20 + 50) = 70, \\ \Delta_{21} &= (-1)^3(-45 - 80) = 125, \end{aligned}$$

$$\begin{aligned} \Delta_{22} &= (-1)^4(225 - 100) = 125, \\ \Delta_{23} &= (-1)^5(-100 - 25) = 125, \\ \Delta_{31} &= (-1)^4(20 + 200) = 220, \\ \Delta_{32} &= (-1)^5(-100 - 100) = 200, \\ \Delta_{33} &= (-1)^6(250 - 25) = 225. \end{aligned}$$

The cofactor matrix is

$$\mathbf{B} = \begin{bmatrix} 74 & 65 & 70 \\ 125 & 125 & 125 \\ 220 & 200 & 225 \end{bmatrix}, \quad (\text{A.74})$$

from which we can write the adjoint of  $\mathbf{A}$ :

$$\text{adj } \mathbf{A} = \mathbf{B}^T = \begin{bmatrix} 74 & 125 & 220 \\ 65 & 125 & 200 \\ 70 & 125 & 225 \end{bmatrix}. \quad (\text{A.75})$$

The determinant of  $\mathbf{A}$  is

$$\begin{aligned} \det \mathbf{A} &= \begin{vmatrix} 25 & -5 & -20 \\ -5 & 10 & -4 \\ -5 & -4 & 9 \end{vmatrix} \\ &= 25(90 - 16) + 5(-45 - 80) - 5(20 + 200) = 125. \end{aligned}$$

It follows from Eq. A.73 that

$$\mathbf{A}^{-1} = \frac{1}{125} \begin{bmatrix} 74 & 125 & 220 \\ 65 & 125 & 200 \\ 70 & 125 & 225 \end{bmatrix}. \quad (\text{A.76})$$

The solution for  $\mathbf{I}$  is

$$\mathbf{I} = \frac{1}{125} \begin{bmatrix} 74 & 125 & 220 \\ 65 & 125 & 200 \\ 70 & 125 & 225 \end{bmatrix} \begin{bmatrix} 50 \\ 0 \\ 0 \end{bmatrix} = \begin{bmatrix} 29.60 \\ 26.00 \\ 28.00 \end{bmatrix}. \quad (\text{A.77})$$

The mesh currents follow directly from Eq. A.77. Thus

$$\begin{bmatrix} i_1 \\ i_2 \\ i_3 \end{bmatrix} = \begin{bmatrix} 29.6 \\ 26.0 \\ 28.0 \end{bmatrix} \quad (\text{A.78})$$

or  $i_1 = 29.6 \text{ A}$ ,  $i_2 = 26 \text{ A}$ , and  $i_3 = 28 \text{ A}$ . Example A.3 illustrates the application of the matrix method when the elements of the matrix are complex numbers.

**Example A.3**

Use the matrix method to find the phasor mesh currents  $\mathbf{I}_1$  and  $\mathbf{I}_2$  in the circuit in Fig. 9.37.

**Solution**

Summing the voltages around mesh 1 generates the equation

$$(1 + j2)\mathbf{I}_1 + (12 - j16)(\mathbf{I}_1 - \mathbf{I}_2) = 150\angle 0^\circ. \quad (\text{A.79})$$

Summing the voltages around mesh 2 produces the equation

$$(12 - j16)(\mathbf{I}_2 - \mathbf{I}_1) + (1 + j3)\mathbf{I}_2 + 39\mathbf{I}_x = 0. \quad (\text{A.80})$$

The current controlling the dependent voltage source is

$$\mathbf{I}_x = (\mathbf{I}_1 - \mathbf{I}_2). \quad (\text{A.81})$$

After substituting Eq. A.81 into Eq. A.80, the equations are put into a matrix format by first collecting, in each equation, the coefficients of  $\mathbf{I}_1$  and  $\mathbf{I}_2$ ; thus

$$\begin{aligned} (13 - j14)\mathbf{I}_1 - (12 - j16)\mathbf{I}_2 &= 150\angle 0^\circ, \\ (27 + j16)\mathbf{I}_1 - (26 + j13)\mathbf{I}_2 &= 0. \end{aligned} \quad (\text{A.82})$$

Now, using matrix notation, Eq. A.82 is written

$$\mathbf{A}\mathbf{I} = \mathbf{V}, \quad (\text{A.83})$$

where

$$\mathbf{A} = \begin{bmatrix} 13 - j14 & -(12 - j16) \\ 27 + j16 & -(26 + j13) \end{bmatrix},$$

$$\mathbf{I} = \begin{bmatrix} \mathbf{I}_1 \\ \mathbf{I}_2 \end{bmatrix}, \quad \text{and} \quad \mathbf{V} = \begin{bmatrix} 150\angle 0^\circ \\ 0 \end{bmatrix}.$$

It follows from Eq. A.83 that

$$\mathbf{I} = \mathbf{A}^{-1}\mathbf{V}. \quad (\text{A.84})$$

The inverse of the coefficient matrix  $\mathbf{A}$  is found using Eq. A.73. In this case, the cofactors of  $\mathbf{A}$  are

$$\begin{aligned} \Delta_{11} &= (-1)^2(-26 - j13) = -26 - j13, \\ \Delta_{12} &= (-1)^3(27 + j16) = -27 - j16, \\ \Delta_{21} &= (-1)^3(-12 + j16) = 12 - j16, \\ \Delta_{22} &= (-1)^4(13 - j14) = 13 - j14. \end{aligned}$$

The cofactor matrix  $\mathbf{B}$  is

$$\mathbf{B} = \begin{bmatrix} (-26 - j13) & (-27 - j16) \\ (12 - j16) & (13 - j14) \end{bmatrix}. \quad (\text{A.85})$$

The adjoint of  $\mathbf{A}$  is

$$\text{adj } \mathbf{A} = \mathbf{B}^T = \begin{bmatrix} (-26 - j13) & (12 - j16) \\ (-27 - j16) & (13 - j14) \end{bmatrix}. \quad (\text{A.86})$$

The determinant of  $\mathbf{A}$  is

$$\begin{aligned} \det \mathbf{A} &= \begin{vmatrix} (13 - j14) & -(12 - j16) \\ (27 + j16) & -(26 + j13) \end{vmatrix} \\ &= -(13 - j14)(26 + j13) + (12 - j16)(27 + j16) \\ &= 60 - j45. \end{aligned} \quad (\text{A.87})$$

The inverse of the coefficient matrix is

$$\mathbf{A}^{-1} = \frac{\begin{bmatrix} (-26 - j13) & (12 - j16) \\ (-27 - j16) & (13 - j14) \end{bmatrix}}{(60 - j45)}. \quad (\text{A.88})$$

Equation A.88 can be simplified to

$$\begin{aligned} \mathbf{A}^{-1} &= \frac{60 + j45}{5625} \begin{bmatrix} (-26 - j13) & (12 - j16) \\ (-27 - j16) & (13 - j14) \end{bmatrix} \\ &= \frac{1}{375} \begin{bmatrix} -65 - j130 & 96 - j28 \\ -60 - j145 & 94 - j17 \end{bmatrix}. \end{aligned} \quad (\text{A.89})$$

Substituting Eq. A.89 into A.84 gives us

$$\begin{aligned} \begin{bmatrix} \mathbf{I}_1 \\ \mathbf{I}_2 \end{bmatrix} &= \frac{1}{375} \begin{bmatrix} (-65 - j130) & (96 - j28) \\ (-60 - j145) & (94 - j17) \end{bmatrix} \begin{bmatrix} 150\angle 0^\circ \\ 0 \end{bmatrix} \\ &= \begin{bmatrix} (-26 - j52) \\ (-24 - j58) \end{bmatrix}. \end{aligned} \quad (\text{A.90})$$

It follows from Eq. A.90 that

$$\begin{aligned} \mathbf{I}_1 &= (-26 - j52) = 58.14\angle -116.57^\circ \text{ A}, \\ \mathbf{I}_2 &= (-24 - j58) = 62.77\angle -122.48^\circ \text{ A}. \end{aligned} \quad (\text{A.91})$$

In the first three examples, the matrix elements have been numbers—real numbers in Examples A.1 and A.2, and complex numbers in Example A.3. It is also possible for the elements to be functions. Example A.4 illustrates the use of matrix algebra in a circuit problem where the elements in the coefficient matrix are functions.

**Example A.4**

Use the matrix method to derive expressions for the node voltages  $V_1$  and  $V_2$  in the circuit in Fig. A.1.

**Solution**

Summing the currents away from nodes 1 and 2 generates the following set of equations:

$$\begin{aligned} \frac{V_1 - V_g}{R} + V_1 sC + (V_1 - V_2)sC &= 0, \\ \frac{V_2}{R} + (V_2 - V_1)sC + (V_2 - V_g)sC &= 0. \end{aligned} \quad (\text{A.92})$$

Letting  $G = 1/R$  and collecting the coefficients of  $V_1$  and  $V_2$  gives us

$$\begin{aligned} (G + 2sC)V_1 - sCV_2 &= GV_g, \\ -sCV_1 + (G + 2sC)V_2 &= sCV_g. \end{aligned} \quad (\text{A.93})$$

Writing Eq. A.93 in matrix notation yields

$$\mathbf{A}\mathbf{V} = \mathbf{I}, \quad (\text{A.94})$$

where

$$\mathbf{A} = \begin{bmatrix} G + 2sC & -sC \\ -sC & G + 2sC \end{bmatrix},$$

$$\mathbf{V} = \begin{bmatrix} V_1 \\ V_2 \end{bmatrix}, \quad \text{and} \quad \mathbf{I} = \begin{bmatrix} GV_g \\ sCV_g \end{bmatrix}.$$

It follows from Eq. A.94 that

$$\mathbf{V} = \mathbf{A}^{-1}\mathbf{I}. \quad (\text{A.95})$$

As before, we find the inverse of the coefficient matrix by first finding the adjoint of  $\mathbf{A}$  and the determinant of  $\mathbf{A}$ . The cofactors of  $\mathbf{A}$  are

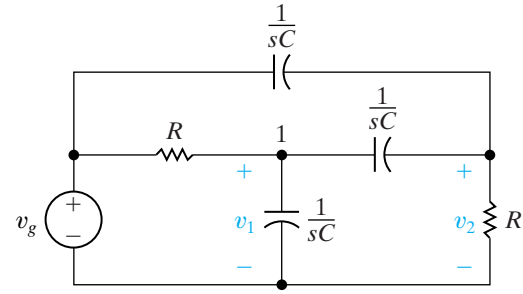
$$\begin{aligned} \Delta_{11} &= (-1)^2[G + 2sC] = G + 2sC, \\ \Delta_{12} &= (-1)^3(-sC) = sC, \\ \Delta_{21} &= (-1)^3(-sC) = sC, \\ \Delta_{22} &= (-1)^4[G + 2sC] = G + 2sC. \end{aligned}$$

The cofactor matrix is

$$\mathbf{B} = \begin{bmatrix} G + 2sC & sC \\ sC & G + 2sC \end{bmatrix}, \quad (\text{A.96})$$

and therefore the adjoint of the coefficient matrix is

$$\text{adj } \mathbf{A} = \mathbf{B}^T = \begin{bmatrix} G + 2sC & sC \\ sC & G + 2sC \end{bmatrix}. \quad (\text{A.97})$$



**Figure A.1** ▲ The circuit for Example A.4.

The determinant of  $\mathbf{A}$  is

$$\det \mathbf{A} = \begin{vmatrix} G + 2sC & sC \\ sC & G + 2sC \end{vmatrix} = G^2 + 4sCG + 3s^2C^2. \quad (\text{A.98})$$

The inverse of the coefficient matrix is

$$\mathbf{A}^{-1} = \frac{\begin{bmatrix} G + 2sC & sC \\ sC & G + 2sC \end{bmatrix}}{(G^2 + 4sCG + 3s^2C^2)}. \quad (\text{A.99})$$

It follows from Eq. A.95 that

$$\begin{bmatrix} V_1 \\ V_2 \end{bmatrix} = \frac{\begin{bmatrix} G + 2sC & sC \\ sC & G + 2sC \end{bmatrix} \begin{bmatrix} GV_g \\ sCV_g \end{bmatrix}}{(G^2 + 4sCG + 3s^2C^2)}. \quad (\text{A.100})$$

Carrying out the matrix multiplication called for in Eq. A.100 gives

$$\begin{bmatrix} V_1 \\ V_2 \end{bmatrix} = \frac{1}{(G^2 + 4sCG + 3s^2C^2)} \begin{bmatrix} (G^2 + 2sCG + s^2C^2)V_g \\ (2sCG + 2s^2C^2)V_g \end{bmatrix}. \quad (\text{A.101})$$

Now the expressions for  $V_1$  and  $V_2$  can be written directly from Eq. A.101; thus

$$V_1 = \frac{(G^2 + 2sCG + s^2C^2)V_g}{(G^2 + 4sCG + 3s^2C^2)}, \quad (\text{A.102})$$

and

$$V_2 = \frac{2(sCG + s^2C^2)V_g}{(G^2 + 4sCG + 3s^2C^2)}. \quad (\text{A.103})$$

In our final example, we illustrate how matrix algebra can be used to analyze the cascade connection of two two-port circuits.

### Example A.5

Show by means of matrix algebra how the input variables  $V_1$  and  $I_1$  can be described as functions of the output variables  $V_2$  and  $I_2$  in the cascade connection shown in Fig. 18.10.

### Solution

We begin by expressing, in matrix notation, the relationship between the input and output variables of each two-port circuit. Thus

$$\begin{bmatrix} V_1 \\ I_1 \end{bmatrix} = \begin{bmatrix} a'_{11} & -a'_{12} \\ a'_{21} & -a'_{22} \end{bmatrix} \begin{bmatrix} V_2' \\ I_2' \end{bmatrix}, \quad (\text{A.104})$$

and

$$\begin{bmatrix} V_1' \\ I_1' \end{bmatrix} = \begin{bmatrix} a''_{11} & -a''_{12} \\ a''_{21} & -a''_{22} \end{bmatrix} \begin{bmatrix} V_2 \\ I_2 \end{bmatrix}, \quad (\text{A.105})$$

Now the cascade connection imposes the constraints

$$V_2' = V_1' \quad \text{and} \quad I_2' = -I_1'. \quad (\text{A.106})$$

These constraint relationships are substituted into Eq. A.104. Thus

$$\begin{aligned} \begin{bmatrix} V_1 \\ I_1 \end{bmatrix} &= \begin{bmatrix} a'_{11} & -a'_{12} \\ a'_{21} & -a'_{22} \end{bmatrix} \begin{bmatrix} V_1' \\ -I_1' \end{bmatrix} \\ &= \begin{bmatrix} a'_{11} & a'_{12} \\ a'_{21} & a'_{22} \end{bmatrix} \begin{bmatrix} V_1' \\ I_1' \end{bmatrix}. \end{aligned} \quad (\text{A.107})$$

The relationship between the input variables  $(V_1, I_1)$  and the output variables  $(V_2, I_2)$  is obtained by substituting Eq. A.105 into Eq. A.107. The result is

$$\begin{bmatrix} V_1 \\ I_1 \end{bmatrix} = \begin{bmatrix} a'_{11} & a'_{12} \\ a'_{21} & a'_{22} \end{bmatrix} \begin{bmatrix} a''_{11} & -a''_{12} \\ a''_{21} & -a''_{22} \end{bmatrix} \begin{bmatrix} V_2 \\ I_2 \end{bmatrix}. \quad (\text{A.108})$$

After multiplying the coefficient matrices, we have

$$\begin{bmatrix} V_1 \\ I_1 \end{bmatrix} = \begin{bmatrix} (a'_{11}a''_{11} + a'_{12}a''_{21}) & -(a'_{11}a''_{12} + a'_{12}a''_{22}) \\ (a'_{21}a''_{11} + a'_{22}a''_{21}) & -(a'_{21}a''_{12} + a'_{22}a''_{22}) \end{bmatrix} \begin{bmatrix} V_2 \\ I_2 \end{bmatrix}. \quad (\text{A.109})$$

Note that Eq. A.109 corresponds to writing Eqs. 18.72 and 18.73 in matrix form.



## Appendix **B** Complex Numbers

Complex numbers were invented to permit the extraction of the square roots of negative numbers. Complex numbers simplify the solution of problems that would otherwise be very difficult. The equation  $x^2 + 8x + 41 = 0$ , for example, has no solution in a number system that excludes complex numbers. These numbers, and the ability to manipulate them algebraically, are extremely useful in circuit analysis.

### B.1 Notation

There are two ways to designate a complex number: with the cartesian, or rectangular, form or with the polar, or trigonometric, form. In the **rectangular form**, a complex number is written in terms of its real and imaginary components; hence

$$n = a + jb, \quad (\text{B.1})$$

where  $a$  is the real component,  $b$  is the imaginary component, and  $j$  is by definition  $\sqrt{-1}$ .<sup>1</sup>

In the **polar form**, a complex number is written in terms of its magnitude (or modulus) and angle (or argument); hence

$$n = ce^{j\theta} \quad (\text{B.2})$$

where  $c$  is the magnitude,  $\theta$  is the angle,  $e$  is the base of the natural logarithm, and, as before,  $j = \sqrt{-1}$ . In the literature, the symbol  $\angle\theta^\circ$  is frequently used in place of  $e^{j\theta}$ ; that is, the polar form is written

$$n = c\angle\theta^\circ. \quad (\text{B.3})$$

Although Eq. B.3 is more convenient in printing text material, Eq. B.2 is of primary importance in mathematical operations because the rules for manipulating an exponential quantity are well known. For example, because  $(y^x)^n = y^{xn}$ , then  $(e^{j\theta})^n = e^{jn\theta}$ ; because  $y^{-x} = 1/y^x$ , then  $e^{-j\theta} = 1/e^{j\theta}$ ; and so forth.

Because there are two ways of expressing the same complex number, we need to relate one form to the other. The transition from the polar to the rectangular form makes use of Euler's identity:

$$e^{\pm j\theta} = \cos \theta \pm j \sin \theta. \quad (\text{B.4})$$

<sup>1</sup> You may be more familiar with the notation  $i = \sqrt{-1}$ . In electrical engineering,  $i$  is used as the symbol for current, and hence in electrical engineering literature,  $j$  is used to denote  $\sqrt{-1}$ .



A complex number in polar form can be put in rectangular form by writing

$$\begin{aligned} ce^{j\theta} &= c(\cos \theta + j \sin \theta) \\ &= c \cos \theta + jc \sin \theta \\ &= a + jb. \end{aligned} \quad (\text{B.5})$$

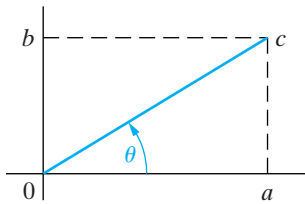
The transition from rectangular to polar form makes use of the geometry of the right triangle, namely,

$$\begin{aligned} a + jb &= \left( \sqrt{a^2 + b^2} \right) e^{j\theta} \\ &= ce^{j\theta}, \end{aligned} \quad (\text{B.6})$$

where

$$\tan \theta = b/a. \quad (\text{B.7})$$

It is not obvious from Eq. B.7 in which quadrant the angle  $\theta$  lies. The ambiguity can be resolved by a graphical representation of the complex number.



**Figure B.1** ▲ The graphical representation of  $a + jb$  when  $a$  and  $b$  are both positive.

## B.2 The Graphical Representation of a Complex Number

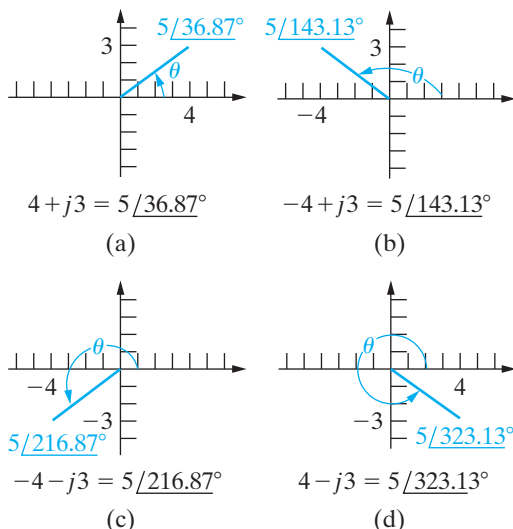
A complex number is represented graphically on a complex-number plane, which uses the horizontal axis for plotting the real component and the vertical axis for plotting the imaginary component. The angle of the complex number is measured counterclockwise from the positive real axis. The graphical plot of the complex number  $n = a + jb = c \angle \theta^\circ$ , if we assume that  $a$  and  $b$  are both positive, is shown in Fig. B.1.

This plot makes very clear the relationship between the rectangular and polar forms. Any point in the complex-number plane is uniquely defined by giving either its distance from each axis (that is,  $a$  and  $b$ ) or its radial distance from the origin ( $c$ ) and the angle of the radial measurement  $\theta$ .

It follows from Fig. B.1 that  $\theta$  is in the first quadrant when  $a$  and  $b$  are both positive, in the second quadrant when  $a$  is negative and  $b$  is positive, in the third quadrant when  $a$  and  $b$  are both negative, and in the fourth quadrant when  $a$  is positive and  $b$  is negative. These observations are illustrated in Fig. B.2, where we have plotted  $4 + j3$ ,  $-4 + j3$ ,  $-4 - j3$ , and  $4 - j3$ .

Note that we can also specify  $\theta$  as a clockwise angle from the positive real axis. Thus in Fig. B.2(c) we could also designate  $-4 - j3$  as  $5 \angle -143.13^\circ$ . In Fig. B.2(d) we observe that  $5 \angle 323.13^\circ = 5 \angle -36.87^\circ$ . It is customary to express  $\theta$  in terms of negative values when  $\theta$  lies in the third or fourth quadrant.

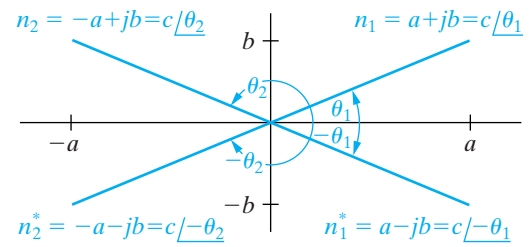
The graphical interpretation of a complex number also shows the relationship between a complex number and its conjugate. The **conjugate of a complex number** is formed by reversing the sign of its imaginary component. Thus the conjugate of  $a + jb$  is  $a - jb$ , and the conjugate of  $-a + jb$  is  $-a - jb$ . When we write a complex number in polar form, we form its conjugate simply by reversing the sign of the angle  $\theta$ . Therefore the conjugate of  $c \angle \theta^\circ$  is  $c \angle -\theta^\circ$ . The conjugate of a complex number is



**Figure B.2** ▲ The graphical representation of four complex numbers.

designated with an asterisk. In other words,  $n^*$  is understood to be the conjugate of  $n$ . Figure B.3 shows two complex numbers and their conjugates plotted on the complex-number plane.

Note that conjugation simply reflects the complex numbers about the real axis.



**Figure B.3** ▲ The complex numbers  $n_1$  and  $n_2$  and their conjugates  $n_1^*$  and  $n_2^*$ .

## B.3 Arithmetic Operations

### Addition (Subtraction)

To add or subtract complex numbers, we must express the numbers in rectangular form. Addition involves adding the real parts of the complex numbers to form the real part of the sum, and the imaginary parts to form the imaginary part of the sum. Thus, if we are given

$$n_1 = 8 + j16$$

and

$$n_2 = 12 - j3,$$

then

$$n_1 + n_2 = (8 + 12) + j(16 - 3) = 20 + j13.$$

Subtraction follows the same rule. Thus

$$n_2 - n_1 = (12 - 8) + j(-3 - 16) = 4 - j19.$$

If the numbers to be added or subtracted are given in polar form, they are first converted to rectangular form. For example, if

$$n_1 = 10 \angle 53.13^\circ$$

and

$$n_2 = 5 \angle -135^\circ,$$

then

$$\begin{aligned} n_1 + n_2 &= 6 + j8 - 3.535 - j3.535 \\ &= (6 - 3.535) + j(8 - 3.535) \\ &= 2.465 + j4.465 = 5.10 \angle 61.10^\circ, \end{aligned}$$

and

$$\begin{aligned} n_1 - n_2 &= 6 + j8 - (-3.535 - j3.535) \\ &= 9.535 + j11.535 \\ &= 14.966 \angle 50.42^\circ. \end{aligned}$$

## Multiplication (Division)

Multiplication or division of complex numbers can be carried out with the numbers written in either rectangular or polar form. However, in most cases, the polar form is more convenient. As an example, let's find the product  $n_1n_2$  when  $n_1 = 8 + j10$  and  $n_2 = 5 - j4$ . Using the rectangular form, we have

$$\begin{aligned}n_1n_2 &= (8 + j10)(5 - j4) = 40 - j32 + j50 + 40 \\ &= 80 + j18 \\ &= 82 \angle 12.68^\circ.\end{aligned}$$

If we use the polar form, the multiplication  $n_1n_2$  becomes

$$\begin{aligned}n_1n_2 &= (12.81 \angle 51.34^\circ)(6.40 \angle -38.66^\circ) \\ &= 82 \angle 12.68^\circ \\ &= 80 + j18.\end{aligned}$$

The first step in dividing two complex numbers in rectangular form is to multiply the numerator and denominator by the conjugate of the denominator. This reduces the denominator to a real number. We then divide the real number into the new numerator. As an example, let's find the value of  $n_1/n_2$ , where  $n_1 = 6 + j3$  and  $n_2 = 3 - j1$ . We have

$$\begin{aligned}\frac{n_1}{n_2} &= \frac{6 + j3}{3 - j1} = \frac{(6 + j3)(3 + j1)}{(3 - j1)(3 + j1)} \\ &= \frac{18 + j6 + j9 - 3}{9 + 1} \\ &= \frac{15 + j15}{10} = 1.5 + j1.5 \\ &= 2.12 \angle 45^\circ.\end{aligned}$$

In polar form, the division of  $n_1$  by  $n_2$  is

$$\begin{aligned}\frac{n_1}{n_2} &= \frac{6.71 \angle 26.57^\circ}{3.16 \angle -18.43^\circ} = 2.12 \angle 45^\circ \\ &= 1.5 + j1.5.\end{aligned}$$

## B.4 Useful Identities

In working with complex numbers and quantities, the following identities are very useful:

$$\pm j^2 = \mp 1, \tag{B.8}$$

$$(-j)(j) = 1, \tag{B.9}$$

$$j = \frac{1}{-j}, \tag{B.10}$$

$$e^{\pm j\pi} = -1, \quad (\text{B.11})$$

$$e^{\pm j\pi/2} = \pm j. \quad (\text{B.12})$$

Given that  $n = a + jb = c/\underline{\theta^\circ}$ , it follows that

$$nn^* = a^2 + b^2 = c^2, \quad (\text{B.13})$$

$$n + n^* = 2a, \quad (\text{B.14})$$

$$n - n^* = j2b, \quad (\text{B.15})$$

$$n/n^* = 1/\underline{2\theta^\circ}. \quad (\text{B.16})$$

## B.5 The Integer Power of a Complex Number

To raise a complex number to an integer power  $k$ , it is easier to first write the complex number in polar form. Thus

$$\begin{aligned} n^k &= (a + jb)^k \\ &= (ce^{j\theta})^k = c^k e^{jk\theta} \\ &= c^k (\cos k\theta + j \sin k\theta). \end{aligned}$$

For example,

$$\begin{aligned} (2e^{j12^\circ})^5 &= 2^5 e^{j60^\circ} = 32e^{j60^\circ} \\ &= 16 + j27.71, \end{aligned}$$

and

$$\begin{aligned} (3 + j4)^4 &= (5e^{j53.13^\circ})^4 = 5^4 e^{j212.52^\circ} \\ &= 625e^{j212.52^\circ} \\ &= -527 - j336. \end{aligned}$$

## B.6 The Roots of a Complex Number

To find the  $k$ th root of a complex number, we must recognize that we are solving the equation

$$x^k - ce^{j\theta} = 0, \quad (\text{B.17})$$

which is an equation of the  $k$ th degree and therefore has  $k$  roots.

To find the  $k$  roots, we first note that

$$ce^{j\theta} = ce^{j(\theta+2\pi)} = ce^{j(\theta+4\pi)} = \dots \quad (\text{B.18})$$

It follows from Eqs. B.17 and B.18 that

$$x_1 = (ce^{j\theta})^{1/k} = c^{1/k}e^{j\theta/k}, \quad (\text{B.19})$$

$$x_2 = [ce^{j(\theta+2\pi)}]^{1/k} = c^{1/k}e^{j(\theta+2\pi)/k}, \quad (\text{B.20})$$

$$x_3 = [ce^{j(\theta+4\pi)}]^{1/k} = c^{1/k}e^{j(\theta+4\pi)/k}, \quad (\text{B.21})$$

$\vdots$

We continue the process outlined by Eqs. B.19, B.20, and B.21 until the roots start repeating. This will happen when the multiple of  $\pi$  is equal to  $2k$ . For example, let's find the four roots of  $81e^{j60^\circ}$ . We have

$$x_1 = 81^{1/4}e^{j60/4} = 3e^{j15^\circ},$$

$$x_2 = 81^{1/4}e^{j(60+360)/4} = 3e^{j105^\circ},$$

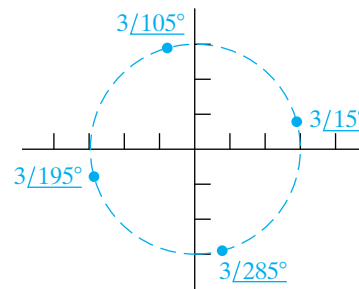
$$x_3 = 81^{1/4}e^{j(60+720)/4} = 3e^{j195^\circ},$$

$$x_4 = 81^{1/4}e^{j(60+1080)/4} = 3e^{j285^\circ},$$

$$x_5 = 81^{1/4}e^{j(60+1440)/4} = 3e^{j375^\circ} = 3e^{j15^\circ}.$$

Here,  $x_5$  is the same as  $x_1$ , so the roots have started to repeat. Therefore we know the four roots of  $81e^{j60^\circ}$  are the values given by  $x_1, x_2, x_3$ , and  $x_4$ .

It is worth noting that the roots of a complex number lie on a circle in the complex-number plane. The radius of the circle is  $c^{1/k}$ . The roots are uniformly distributed around the circle, the angle between adjacent roots being equal to  $2\pi/k$  radians, or  $360/k$  degrees. The four roots of  $81e^{j60^\circ}$  are shown plotted in Fig. B.4.



**Figure B.4** ▲ The four roots of  $81e^{j60^\circ}$ .

# C More on Magnetically Coupled Coils and Ideal Transformers

## C.1 Equivalent Circuits for Magnetically Coupled Coils

At times, it is convenient to model magnetically coupled coils with an equivalent circuit that does not involve magnetic coupling. Consider the two magnetically coupled coils shown in Fig. C.1. The resistances  $R_1$  and  $R_2$  represent the winding resistance of each coil. The goal is to replace the magnetically coupled coils inside the shaded area with a set of inductors that are not magnetically coupled. Before deriving the equivalent circuits, we must point out an important restriction: The voltage between terminals b and d must be zero. In other words, if terminals b and d can be shorted together without disturbing the voltages and currents in the original circuit, the equivalent circuits derived in the material that follows can be used to model the coils. This restriction is imposed because, while the equivalent circuits we develop both have four terminals, two of those four terminals are shorted together. Thus, the same requirement is placed on the original circuits.

We begin developing the circuit models by writing the two equations that relate the terminal voltages  $v_1$  and  $v_2$  to the terminal currents  $i_1$  and  $i_2$ . For the given references and polarity dots,

$$v_1 = L_1 \frac{di_1}{dt} + M \frac{di_2}{dt} \quad (\text{C.1})$$

and

$$v_2 = M \frac{di_1}{dt} + L_2 \frac{di_2}{dt}. \quad (\text{C.2})$$

### The T-Equivalent Circuit

To arrive at an equivalent circuit for these two magnetically coupled coils, we seek an arrangement of inductors that can be described by a set of equations equivalent to Eqs. C.1 and C.2. The key to finding the arrangement is to regard Eqs. C.1 and C.2 as mesh-current equations with  $i_1$  and  $i_2$  as the mesh variables. Then we need one mesh with a total inductance of  $L_1$  H and a second mesh with a total inductance of  $L_2$  H. Furthermore, the two meshes must have a common inductance of  $M$  H. The T-arrangement of coils shown in Fig. C.2 satisfies these requirements.

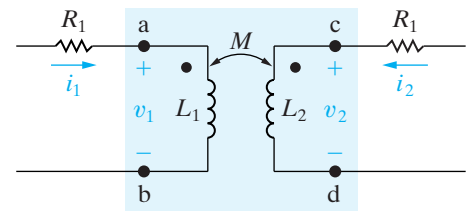


Figure C.1 ▲ The circuit used to develop an equivalent circuit for magnetically coupled coils.

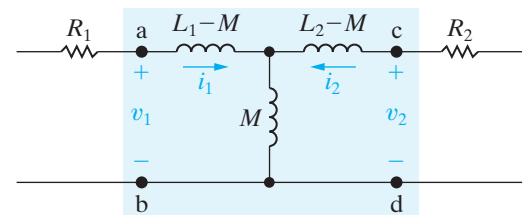


Figure C.2 ▲ The T-equivalent circuit for the magnetically coupled coils of Fig. C.1.

You should verify that the equations relating  $v_1$  and  $v_2$  to  $i_1$  and  $i_2$  reduce to Eqs. C.1 and C.2. Note the absence of magnetic coupling between the inductors and the zero voltage between b and d.

### The $\pi$ -Equivalent Circuit

We can derive a  $\pi$ -equivalent circuit for the magnetically coupled coils shown in Fig. C.1. This derivation is based on solving Eqs. C.1 and C.2 for the derivatives  $di_1/dt$  and  $di_2/dt$  and then regarding the resulting expressions as a pair of node-voltage equations. Using Cramer's method for solving simultaneous equations, we obtain expressions for  $di_1/dt$  and  $di_2/dt$ :

$$\frac{di_1}{dt} = \frac{\begin{vmatrix} v_1 & M \\ v_2 & L_2 \end{vmatrix}}{\begin{vmatrix} L_1 & M \\ M & L_2 \end{vmatrix}} = \frac{L_2}{L_1L_2 - M^2}v_1 - \frac{M}{L_1L_2 - M^2}v_2; \quad (\text{C.3})$$

$$\frac{di_2}{dt} = \frac{\begin{vmatrix} L_1 & v_1 \\ M & v_2 \end{vmatrix}}{L_1L_2 - M^2} = \frac{-M}{L_1L_2 - M^2}v_1 + \frac{L_1}{L_1L_2 - M^2}v_2. \quad (\text{C.4})$$

Now we solve for  $i_1$  and  $i_2$  by multiplying both sides of Eqs. C.3 and C.4 by  $dt$  and then integrating:

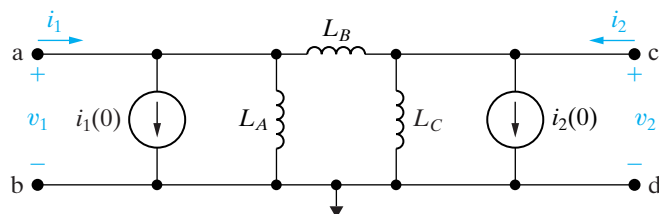
$$i_1 = i_1(0) + \frac{L_2}{L_1L_2 - M^2} \int_0^t v_1 d\tau - \frac{M}{L_1L_2 - M^2} \int_0^t v_2 d\tau \quad (\text{C.5})$$

and

$$i_2 = i_2(0) - \frac{M}{L_1L_2 - M^2} \int_0^t v_1 d\tau + \frac{L_1}{L_1L_2 - M^2} \int_0^t v_2 d\tau. \quad (\text{C.6})$$

If we regard  $v_1$  and  $v_2$  as node voltages, Eqs. C.5 and C.6 describe a circuit of the form shown in Fig. C.3.

All that remains to be done in deriving the  $\pi$ -equivalent circuit is to find  $L_A$ ,  $L_B$ , and  $L_C$  as functions of  $L_1$ ,  $L_2$ , and  $M$ . We easily do so by writing the equations for  $i_1$  and  $i_2$  in Fig. C.3 and then comparing them with Eqs. C.5 and C.6. Thus



**Figure C.3** ▲ The circuit used to derive the  $\pi$ -equivalent circuit for magnetically coupled coils.

$$\begin{aligned}
 i_1 &= i_1(0) + \frac{1}{L_A} \int_0^t v_1 d\tau + \frac{1}{L_B} \int_0^t (v_1 - v_2) d\tau \\
 &= i_1(0) + \left( \frac{1}{L_A} + \frac{1}{L_B} \right) \int_0^t v_1 d\tau - \frac{1}{L_B} \int_0^t v_2 d\tau \quad (C.7)
 \end{aligned}$$

and

$$\begin{aligned}
 i_2 &= i_2(0) + \frac{1}{L_C} \int_0^t v_2 d\tau + \frac{1}{L_B} \int_0^t (v_2 - v_1) d\tau \\
 &= i_2(0) + \frac{1}{L_B} \int_0^t v_1 d\tau + \left( \frac{1}{L_B} + \frac{1}{L_C} \right) \int_0^t v_2 d\tau. \quad (C.8)
 \end{aligned}$$

Then

$$\frac{1}{L_B} = \frac{M}{L_1 L_2 - M^2}, \quad (C.9)$$

$$\frac{1}{L_A} = \frac{L_2 - M}{L_1 L_2 - M^2}, \quad (C.10)$$

$$\frac{1}{L_C} = \frac{L_1 - M}{L_1 L_2 - M^2}. \quad (C.11)$$

When we incorporate Eqs. C.9–C.11 into the circuit shown in Fig. C.3, the  $\pi$ -equivalent circuit for the magnetically coupled coils shown in Fig. C.1 is as shown in Fig. C.4.

Note that the initial values of  $i_1$  and  $i_2$  are explicit in the  $\pi$ -equivalent circuit but implicit in the T-equivalent circuit. We are focusing on the sinusoidal steady-state behavior of circuits containing mutual inductance, so we can assume that the initial values of  $i_1$  and  $i_2$  are zero. We can thus eliminate the current sources in the  $\pi$ -equivalent circuit, and the circuit shown in Fig. C.4 simplifies to the one shown in Fig. C.5.

The mutual inductance carries its own algebraic sign in the T- and  $\pi$ -equivalent circuits. In other words, if the magnetic polarity of the coupled coils is reversed from that given in Fig. C.1, the algebraic sign of  $M$

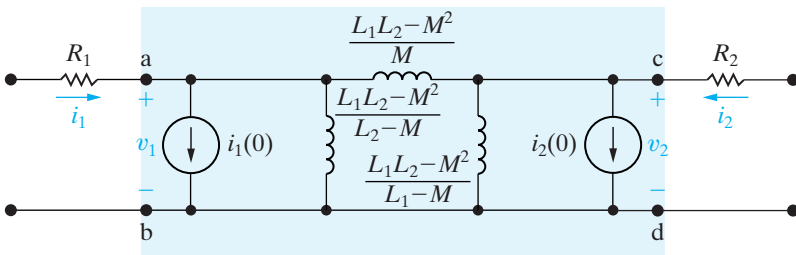


Figure C.4 ▲ The  $\pi$ -equivalent circuit for the magnetically coupled coils of Fig. C.1.

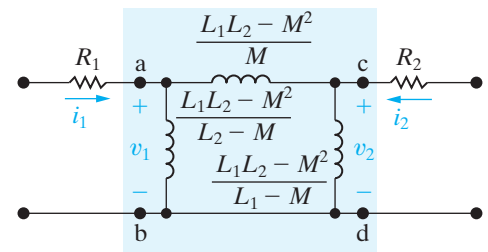


Figure C.5 ▲ The  $\pi$ -equivalent circuit used for sinusoidal steady-state analysis.



reverses. A reversal in magnetic polarity requires moving one polarity dot without changing the reference polarities of the terminal currents and voltages.

Example C.1 illustrates the application of the T-equivalent circuit.

**Example C.1**

- a) Use the T-equivalent circuit for the magnetically coupled coils shown in Fig. C.6 to find the phasor currents  $I_1$  and  $I_2$ . The source frequency is 400 rad/s.
- b) Repeat (a), but with the polarity dot on the secondary winding moved to the lower terminal.

**Solution**

a) For the polarity dots shown in Fig. C.6,  $M$  carries a value of +3 H in the T-equivalent circuit. Therefore the three inductances in the equivalent circuit are

$$L_1 - M = 9 - 3 = 6 \text{ H};$$

$$L_2 - M = 4 - 3 = 1 \text{ H};$$

$$M = 3 \text{ H}.$$

Figure C.7 shows the T-equivalent circuit, and Fig. C.8 shows the frequency-domain equivalent circuit at a frequency of 400 rad/s.

Figure C.9 shows the frequency-domain circuit for the original system.

Here the magnetically coupled coils are modeled by the circuit shown in Fig. C.8. To find the phasor currents  $I_1$  and  $I_2$ , we first find the node voltage across the 1200 Ω inductive reactance. If we use the lower node as the reference, the single node-voltage equation is

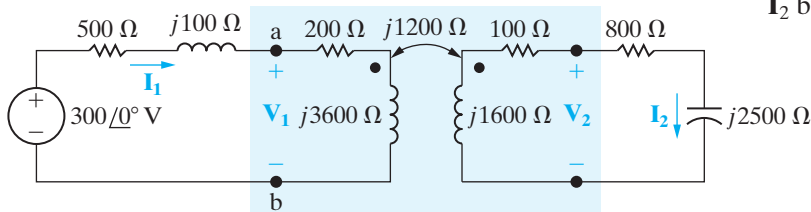
$$\frac{V - 300}{700 + j2500} + \frac{V}{j1200} + \frac{V}{900 - j2100} = 0.$$

Solving for  $V$  yields

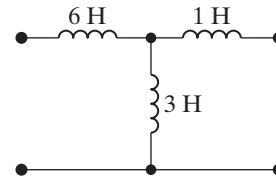
$$V = 136 - j8 = 136.24 \angle -3.37^\circ \text{ V (rms)}.$$

Then

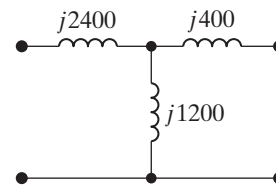
$$I_1 = \frac{300 - (136 - j8)}{700 + j2500} = 63.25 \angle -71.57^\circ \text{ mA (rms)}$$



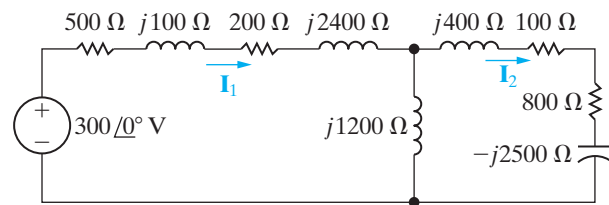
**Figure C.6** ▲ The frequency-domain equivalent circuit for Example C.1.



**Figure C.7** ▲ The T-equivalent circuit for the magnetically coupled coils in Example C.1.



**Figure C.8** ▲ The frequency-domain model of the equivalent circuit at 400 rad/s.



**Figure C.9** ▲ The circuit of Fig. C.6, with the magnetically coupled coils replaced by their T-equivalent circuit.

and

$$I_2 = \frac{136 - j8}{900 - j2100} = 59.63 \angle 63.43^\circ \text{ mA (rms)}.$$

- b) When the polarity dot is moved to the lower terminal of the secondary coil,  $M$  carries a value of -3 H in the T-equivalent circuit. Before carrying out the solution with the new T-equivalent circuit, we note that reversing the algebraic sign of  $M$  has no effect on the solution for  $I_1$  and shifts  $I_2$  by 180°. Therefore we anticipate that

$$\mathbf{I}_1 = 63.25 \angle -71.57^\circ \text{ mA (rms)}$$

and

$$\mathbf{I}_2 = 59.63 \angle -116.57^\circ \text{ mA (rms)}.$$

We now proceed to find these solutions by using the new T-equivalent circuit. With  $M = -3 \text{ H}$ , the three inductances in the equivalent circuit are

$$L_1 - M = 9 - (-3) = 12 \text{ H};$$

$$L_2 - M = 4 - (-3) = 7 \text{ H};$$

$$M = -3 \text{ H}.$$

At an operating frequency of  $400 \text{ rad/s}$ , the frequency-domain equivalent circuit requires two inductors and a capacitor, as shown in Fig. C.10.

The resulting frequency-domain circuit for the original system appears in Fig. C.11.

As before, we first find the node voltage across the center branch, which in this case is a capacitive reactance of  $-j1200 \Omega$ . If we use the lower node as reference, the node-voltage equation is

$$\frac{\mathbf{V} - 300}{700 + j4900} + \frac{\mathbf{V}}{-j1200} + \frac{\mathbf{V}}{900 + j300} = 0.$$

Solving for  $\mathbf{V}$  gives

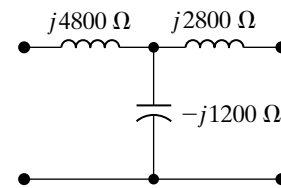
$$\begin{aligned} \mathbf{V} &= -8 - j56 \\ &= 56.57 \angle -98.13^\circ \text{ V (rms)}. \end{aligned}$$

Then

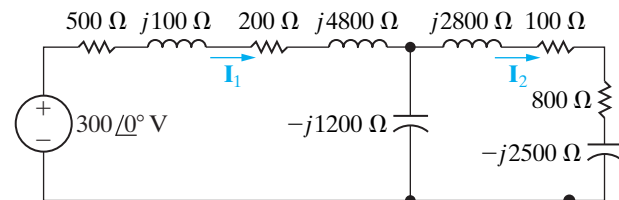
$$\begin{aligned} \mathbf{I}_1 &= \frac{300 - (-8 - j56)}{700 + j4900} \\ &= 63.25 \angle -71.57^\circ \text{ mA (rms)} \end{aligned}$$

and

$$\begin{aligned} \mathbf{I}_2 &= \frac{-8 - j56}{900 + j300} \\ &= 59.63 \angle -116.57^\circ \text{ mA (rms)}. \end{aligned}$$



**Figure C.10** ▲ The frequency-domain equivalent circuit for  $M = -3 \text{ H}$  and  $\omega = 400 \text{ rad/s}$ .



**Figure C.11** ▲ The frequency-domain equivalent circuit for Example C.1(b).

## C.2 The Need for Ideal Transformers in the Equivalent Circuits

The inductors in the T- and  $\pi$ -equivalent circuits of magnetically coupled coils can have negative values. For example, if  $L_1 = 3 \text{ mH}$ ,  $L_2 = 12 \text{ mH}$ , and  $M = 5 \text{ mH}$ , the T-equivalent circuit requires an inductor of  $-2 \text{ mH}$ , and the  $\pi$ -equivalent circuit requires an inductor of  $-5.5 \text{ mH}$ . These negative inductance values are not troublesome when you are using the equivalent circuits in computations. However, if you are to build the equivalent circuits with circuit components, the negative inductors can be bothersome. The reason is that whenever the frequency of the sinusoidal source changes, you must change the capacitor used to simulate the negative reactance. For example, at a frequency of  $50 \text{ krad/s}$ , a  $-2 \text{ mH}$  inductor has an impedance of  $-j100 \Omega$ . This impedance can be modeled with a capacitor having a capacitance of  $0.2 \mu\text{F}$ . If the frequency changes to  $25 \text{ krad/s}$ , the  $-2 \text{ mH}$  inductor impedance changes to  $-j50 \Omega$ . At  $25 \text{ krad/s}$ , this requires a capacitor with a capacitance of  $0.8 \mu\text{F}$ . Obviously, in a situation where the frequency is varied

continuously, the use of a capacitor to simulate negative inductance is practically worthless.

You can circumvent the problem of dealing with negative inductances by introducing an ideal transformer into the equivalent circuit. This doesn't completely solve the modeling problem, because ideal transformers can only be approximated. However, in some situations the approximation is good enough to warrant a discussion of using an ideal transformer in the T- and  $\pi$ -equivalent circuits of magnetically coupled coils.

An ideal transformer can be used in two different ways in either the T-equivalent or the  $\pi$ -equivalent circuit. Figure C.12 shows the two arrangements for each type of equivalent circuit.

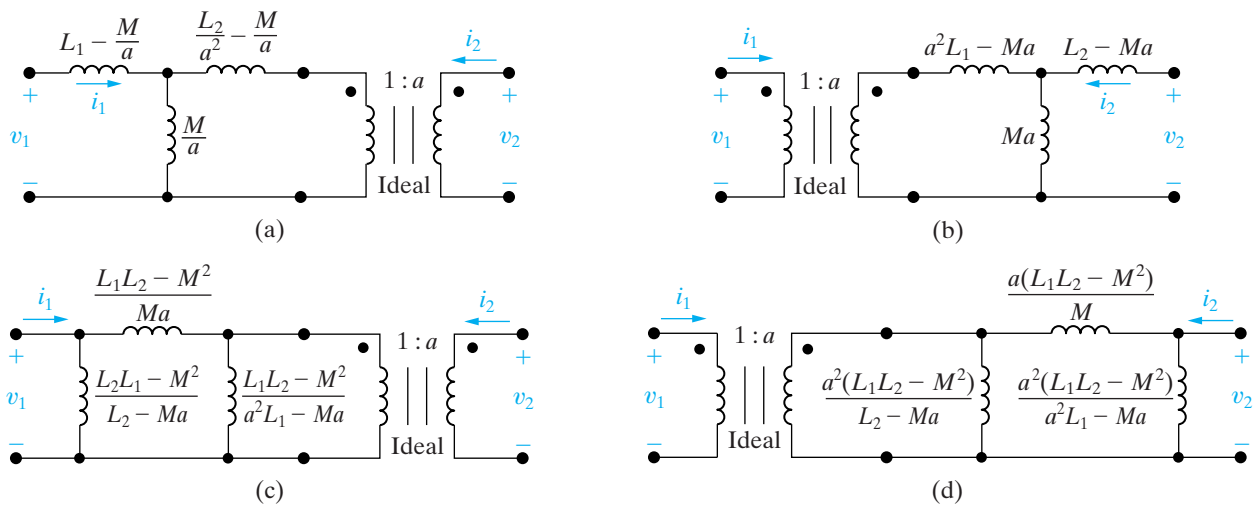
Verifying any of the equivalent circuits in Fig. C.12 requires showing only that, for any circuit, the equations relating  $v_1$  and  $v_2$  to  $di_1/dt$  and  $di_2/dt$  are identical to Eqs. C.1 and C.2. Here, we validate the circuit shown in Fig. C.12(a); we leave it to you to verify the circuits in Figs. C.12(b), (c), and (d). To aid the discussion, we redrew the circuit shown in Fig. C.12(a) as Fig. C.13, adding the variables  $i_0$  and  $v_0$ .

From this circuit,

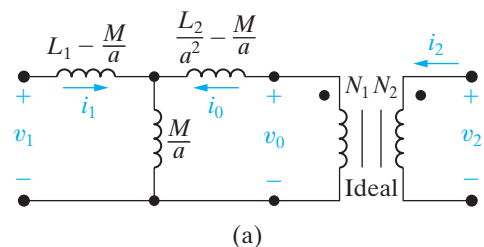
$$v_1 = \left( L_1 - \frac{M}{a} \right) \frac{di_1}{dt} + \frac{M}{a} \frac{d}{dt} (i_1 + i_0) \tag{C.12}$$

and

$$v_0 = \left( \frac{L_2}{a^2} - \frac{M}{a} \right) \frac{di_0}{dt} + \frac{M}{a} \frac{d}{dt} (i_0 + i_1). \tag{C.13}$$



**Figure C.12** ▲ The four ways of using an ideal transformer in the T- and  $\pi$ -equivalent circuit for magnetically coupled coils.



**Figure C.13** ▲ The circuit of Fig. C.12(a) with  $i_0$  and  $v_0$  defined.

The ideal transformer imposes constraints on  $v_0$  and  $i_0$ :

$$v_0 = \frac{v_2}{a}; \tag{C.14}$$

$$i_0 = ai_2. \tag{C.15}$$

Substituting Eqs. C.14 and C.15 into Eqs. C.12 and C.13 gives

$$v_1 = L_1 \frac{di_1}{dt} + \frac{M}{a} \frac{d}{dt}(ai_2) \tag{C.16}$$

and

$$\frac{v_2}{a} = \frac{L_2}{a^2} \frac{d}{dt}(ai_2) + \frac{M}{a} \frac{di_1}{dt}. \tag{C.17}$$

From Eqs. C.16 and C.17,

$$v_1 = L_1 \frac{di_1}{dt} + M \frac{di_2}{dt} \tag{C.18}$$

and

$$v_2 = M \frac{di_1}{dt} + L_2 \frac{di_2}{dt}. \tag{C.19}$$

Equations C.18 and C.19 are identical to Eqs. C.1 and C.2; thus, insofar as terminal behavior is concerned, the circuit shown in Fig. C.13 is equivalent to the magnetically coupled coils shown inside the box in Fig. C.1.

In showing that the circuit in Fig. C.13 is equivalent to the magnetically coupled coils in Fig. C.1, we placed no restrictions on the turns ratio  $a$ . Therefore, an infinite number of equivalent circuits are possible. Furthermore, we can always find a turns ratio to make all the inductances positive. Three values of  $a$  are of particular interest:

$$a = \frac{M}{L_1}, \tag{C.20}$$

$$a = \frac{L_2}{M}, \tag{C.21}$$

and

$$a = \sqrt{\frac{L_2}{L_1}}. \tag{C.22}$$

The value of  $a$  given by Eq. C.20 eliminates the inductances  $L_1 - M/a$  and  $a^2L_1 - aM$  from the T-equivalent circuits and the inductances  $(L_1L_2 - M^2)/(a^2L_1 - aM)$  and  $a^2(L_1L_2 - M^2)/(a^2L_1 - aM)$  from the  $\pi$ -equivalent circuits. The value of  $a$  given by Eq. C.21 eliminates the inductances  $(L_2/a^2) - (M/a)$  and  $L_2 - aM$  from the T-equivalent circuits and the inductances  $(L_1L_2 - M^2)/(L_2 - aM)$  and  $a^2(L_1L_2 - M^2)/(L_2 - aM)$  from the  $\pi$ -equivalent circuits.

Also note that when  $a = M/L_1$ , the circuits in Figs. C.12(a) and (c) become identical, and when  $a = L_2/M$ , the circuits in Figs. C.12(b) and (d) become identical. Figures C.14 and C.15 summarize these observations.

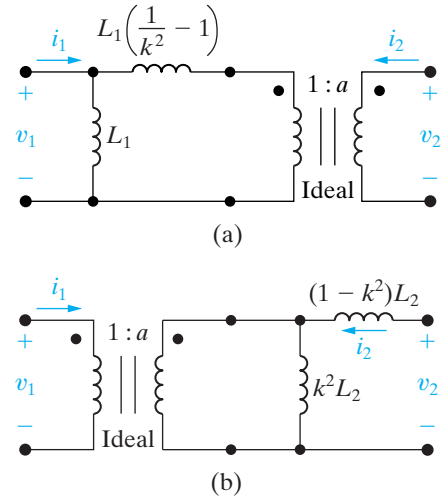


Figure C.14 ▲ Two equivalent circuits when  $a = M/L_1$ .

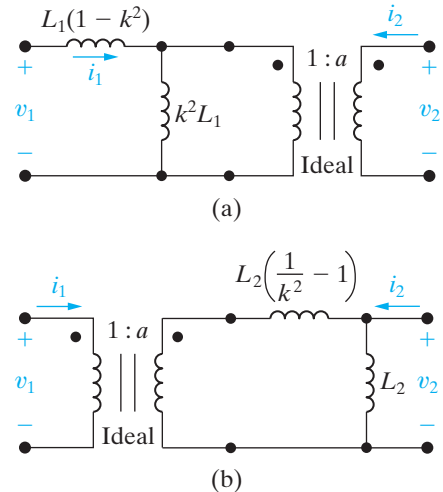


Figure C.15 ▲ Two equivalent circuits when  $a = L_2/M$ .

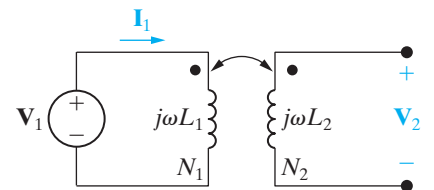


Figure C.16 ▲ Experimental determination of the ratio  $M/L_1$ .

In deriving the expressions for the inductances there, we used the relationship  $M = k\sqrt{L_1L_2}$ . Expressing the inductances as functions of the self-inductances  $L_1$  and  $L_2$  and the coefficient of coupling  $k$  allows the values of  $a$  given by Eqs. C.20 and C.21 not only to reduce the number of inductances needed in the equivalent circuit, but also to guarantee that all the inductances will be positive. We leave to you to investigate the consequences of choosing the value of  $a$  given by Eq. C.22.

The values of  $a$  given by Eqs. C.20–C.22 can be determined experimentally. The ratio  $M/L_1$  is obtained by driving the coil designated as having  $N_1$  turns by a sinusoidal voltage source. The source frequency is set high enough that  $\omega L_1 \gg R_1$ , and the  $N_2$  coil is left open. Figure C.16 shows this arrangement.

With the  $N_2$  coil open,

$$\mathbf{V}_2 = j\omega M \mathbf{I}_1. \quad (\text{C.23})$$

Now, as  $j\omega L_1 \gg R_1$ , the current  $I_1$  is

$$\mathbf{I}_1 = \frac{\mathbf{V}_1}{j\omega L_1}. \quad (\text{C.24})$$

Substituting Eq. C.24 into Eq. C.23 yields

$$\left( \frac{\mathbf{V}_2}{\mathbf{V}_1} \right)_{I_2=0} = \frac{M}{L_1}, \quad (\text{C.25})$$

in which the ratio  $M/L_1$  is the terminal voltage ratio corresponding to coil 2 being open; that is,  $\mathbf{I}_2 = 0$ .

We obtain the ratio  $L_2/M$  by reversing the procedure; that is, coil 2 is energized and coil 1 is left open. Then

$$\frac{L_2}{M} = \left( \frac{\mathbf{V}_2}{\mathbf{V}_1} \right)_{I_1=0}. \quad (\text{C.26})$$

Finally, we observe that the value of  $a$  given by Eq. C.22 is the geometric mean of these two voltage ratios; thus

$$\sqrt{\left( \frac{\mathbf{V}_2}{\mathbf{V}_1} \right)_{I_2=0} \left( \frac{\mathbf{V}_2}{\mathbf{V}_1} \right)_{I_1=0}} = \sqrt{\frac{M}{L_1} \frac{L_2}{M}} = \sqrt{\frac{L_2}{L_1}}. \quad (\text{C.27})$$

For coils wound on nonmagnetic cores, the voltage ratio is not the same as the turns ratio, as it very nearly is for coils wound on ferromagnetic cores. Because the self-inductances vary as the square of the number of turns, Eq. C.27 reveals that the turns ratio is approximately equal to the geometric mean of the two voltage ratios, or

$$\sqrt{\frac{L_2}{L_1}} = \frac{N_2}{N_1} = \sqrt{\left( \frac{\mathbf{V}_2}{\mathbf{V}_1} \right)_{I_2=0} \left( \frac{\mathbf{V}_2}{\mathbf{V}_1} \right)_{I_1=0}}. \quad (\text{C.28})$$

# Appendix D The Decibel

Telephone engineers who were concerned with the power loss across the cascaded circuits used to transmit telephone signals introduced the decibel. Figure D.1 defines the problem.

There,  $p_i$  is the power input to the system,  $p_1$  is the power output of circuit A,  $p_2$  is the power output of circuit B, and  $p_o$  is the power output of the system. The power gain of each circuit is the ratio of the power out to the power in. Thus

$$\sigma_A = \frac{p_1}{p_i}, \quad \sigma_B = \frac{p_2}{p_1}, \quad \text{and} \quad \sigma_C = \frac{p_o}{p_2}.$$

The overall power gain of the system is simply the product of the individual gains, or

$$\frac{p_o}{p_i} = \frac{p_1}{p_i} \frac{p_2}{p_1} \frac{p_o}{p_2} = \sigma_A \sigma_B \sigma_C.$$

The multiplication of power ratios is converted to addition by means of the logarithm; that is,

$$\log_{10} \frac{p_o}{p_i} = \log_{10} \sigma_A + \log_{10} \sigma_B + \log_{10} \sigma_C.$$

This log ratio of the powers was named the **bel**, in honor of Alexander Graham Bell. Thus we calculate the overall power gain, in bels, simply by summing the power gains, also in bels, of each segment of the transmission system. In practice, the bel is an inconveniently large quantity. One-tenth of a bel is a more useful measure of power gain; hence the **decibel**. The number of decibels equals 10 times the number of bels, so

$$\text{Number of decibels} = 10 \log_{10} \frac{p_o}{p_i}.$$

When we use the decibel as a measure of power ratios, in some situations the resistance seen looking into the circuit equals the resistance loading the circuit, as illustrated in Fig. D.2.

When the input resistance equals the load resistance, we can convert the power ratio to either a voltage ratio or a current ratio:

$$\frac{p_o}{p_i} = \frac{v_{\text{out}}^2 / R_L}{v_{\text{in}}^2 / R_{\text{in}}} = \left( \frac{v_{\text{out}}}{v_{\text{in}}} \right)^2$$

or

$$\frac{p_o}{p_i} = \frac{i_{\text{out}}^2 R_L}{i_{\text{in}}^2 R_{\text{in}}} = \left( \frac{i_{\text{out}}}{i_{\text{in}}} \right)^2.$$

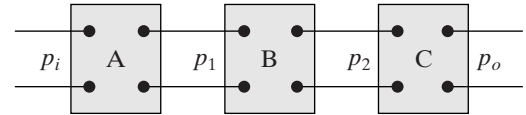


Figure D.1 ▲ Three cascaded circuits.

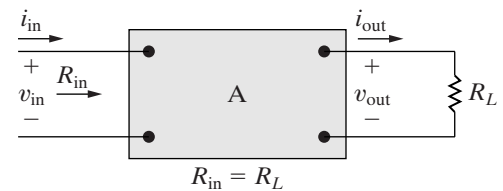


Figure D.2 ▲ A circuit in which the input resistance equals the load resistance.

These equations show that the number of decibels becomes

$$\begin{aligned} \text{Number of decibels} &= 20 \log_{10} \frac{v_{\text{out}}}{v_{\text{in}}} \\ &= 20 \log_{10} \frac{i_{\text{out}}}{i_{\text{in}}}. \end{aligned} \quad (\text{D.1})$$

The definition of the decibel used in Bode diagrams (see Appendix E) is borrowed from the results expressed by Eq. D.1, since these results apply to any transfer function involving a voltage ratio, a current ratio, a voltage-to-current ratio, or a current-to-voltage ratio. You should keep the original definition of the decibel firmly in mind because it is of fundamental importance in many engineering applications.

**TABLE D.1** Some dB-Ratio Pairs

dB	Ratio	dB	Ratio
0	1.00	30	31.62
3	1.41	40	100.00
6	2.00	60	$10^3$
10	3.16	80	$10^4$
15	5.62	100	$10^5$
20	10.00	120	$10^6$

When you are working with transfer function amplitudes expressed in decibels, having a table that translates the decibel value to the actual value of the output/input ratio is helpful. Table D.1 gives some useful pairs. The ratio corresponding to a negative decibel value is the reciprocal of the positive ratio. For example,  $-3$  dB corresponds to an output/input ratio of  $1/1.41$ , or  $0.707$ . Interestingly,  $-3$  dB corresponds to the half-power frequencies of the filter circuits discussed in Chapters 14 and 15.

The decibel is also used as a unit of power when it expresses the ratio of a known power to a reference power. Usually the reference power is  $1$  mW and the power unit is written dBm, which stands for “decibels relative to one milliwatt.” For example, a power of  $20$  mW corresponds to  $\pm 13$  dBm.

AC voltmeters commonly provide dBm readings that assume not only a  $1$  mW reference power but also a  $600 \Omega$  reference resistance (a value commonly used in telephone systems). Since a power of  $1$  mW in  $600 \Omega$  corresponds to  $0.7746$  V (rms), that voltage is read as  $0$  dBm on the meter. For analog meters, there usually is exactly a  $10$  dB difference between adjacent ranges. Although the scales may be marked  $0.1$ ,  $0.3$ ,  $1$ ,  $3$ ,  $10$ , and so on, in fact  $3.16$  V on the  $3$  V scale lines up with  $1$  V on the  $1$  V scale.

Some voltmeters provide a switch to choose a reference resistance ( $50$ ,  $135$ ,  $600$ , or  $900 \Omega$ ) or to select dBm or dBV (decibels relative to one volt).



## Appendix **E** Bode Diagrams

As we have seen, the frequency response plot is a very important tool for analyzing a circuit's behavior. Up to this point, however, we have shown qualitative sketches of the frequency response without discussing how to create such diagrams. The most efficient method for generating and plotting the amplitude and phase data is to use a digital computer; we can rely on it to give us accurate numerical plots of  $|H(j\omega)|$  and  $\theta(j\omega)$  versus  $\omega$ . However, in some situations, preliminary sketches using Bode diagrams can help ensure the intelligent use of the computer.

A Bode diagram, or plot, is a graphical technique that gives a feel for the frequency response of a circuit. These diagrams are named in recognition of the pioneering work done by H. W. Bode.<sup>1</sup> They are most useful for circuits in which the poles and zeros of  $H(s)$  are reasonably well separated.

Like the qualitative frequency response plots seen thus far, a Bode diagram consists of two separate plots: One shows how the amplitude of  $H(j\omega)$  varies with frequency, and the other shows how the phase angle of  $H(j\omega)$  varies with frequency. In Bode diagrams, the plots are made on semilog graph paper for greater accuracy in representing the wide range of frequency values. In both the amplitude and phase plots, the frequency is plotted on the horizontal log scale, and the amplitude and phase angle are plotted on the linear vertical scale.

### E.1 Real, First-Order Poles and Zeros

To simplify the development of Bode diagrams, we begin by considering only cases where all the poles and zeros of  $H(s)$  are real and first order. Later we will present cases with complex and repeated poles and zeros. For our purposes, having a specific expression for  $H(s)$  is helpful. Hence we base the discussion on

$$H(s) = \frac{K(s + z_1)}{s(s + p_1)}, \quad (\text{E.1})$$

from which

$$H(j\omega) = \frac{K(j\omega + z_1)}{j\omega(j\omega + p_1)}. \quad (\text{E.2})$$

The first step in making Bode diagrams is to put the expression for  $H(j\omega)$  in a **standard form**, which we derive simply by dividing out the poles and zeros:

$$H(j\omega) = \frac{Kz_1(1 + j\omega/z_1)}{p_1(j\omega)(1 + j\omega/p_1)}. \quad (\text{E.3})$$

<sup>1</sup> See H. W. Bode, *Network Analysis and Feedback Design* (New York: Van Nostrand, 1945).



Next we let  $K_o$  represent the constant quantity  $K_{z_1/p_1}$ , and at the same time we express  $H(j\omega)$  in polar form:

$$\begin{aligned} H(j\omega) &= \frac{K_o |1 + j\omega/z_1| \angle \psi_1}{|\omega| \angle 90^\circ |1 + j\omega/p_1| \angle \beta_1} \\ &= \frac{K_o |1 + j\omega/z_1|}{|\omega| |1 + j\omega/p_1|} \angle (\psi_1 - 90^\circ - \beta_1). \end{aligned} \quad (\text{E.4})$$

From Eq. E.4,

$$|H(j\omega)| = \frac{K_o |1 + j\omega/z_1|}{\omega |1 + j\omega/p_1|}, \quad (\text{E.5})$$

$$\theta(\omega) = \psi_1 - 90^\circ - \beta_1. \quad (\text{E.6})$$

By definition, the phase angles  $\psi_1$  and  $\beta_1$  are

$$\psi_1 = \tan^{-1} \omega/z_1; \quad (\text{E.7})$$

$$\beta_1 = \tan^{-1} \omega/p_1. \quad (\text{E.8})$$

The Bode diagrams consist of plotting Eq. E.5 (amplitude) and Eq. E.6 (phase) as functions of  $\omega$ .

## E.2 Straight-Line Amplitude Plots

The amplitude plot involves the multiplication and division of factors associated with the poles and zeros of  $H(s)$ . We reduce this multiplication and division to addition and subtraction by expressing the amplitude of  $H(j\omega)$  in terms of a logarithmic value: the decibel (dB).<sup>2</sup> The amplitude of  $H(j\omega)$  in decibels is

$$A_{\text{dB}} = 20 \log_{10} |H(j\omega)|. \quad (\text{E.9})$$

To give you a feel for the unit of decibels, Table E.1 provides a translation between the actual value of several amplitudes and their values in decibels. Expressing Eq. E.5 in terms of decibels gives

$$\begin{aligned} A_{\text{dB}} &= 20 \log_{10} \frac{K_o |1 + j\omega/z_1|}{\omega |1 + j\omega/p_1|} \\ &= 20 \log_{10} K_o + 20 \log_{10} |1 + j\omega/z_1| \\ &\quad - 20 \log_{10} \omega - 20 \log_{10} |1 + j\omega/p_1|. \end{aligned} \quad (\text{E.10})$$

**TABLE E.1** Actual Amplitudes and Their Decibel Values

$A_{\text{dB}}$	$A$	$A_{\text{dB}}$	$A$
0	1.00	30	31.62
3	1.41	40	100.00
6	2.00	60	$10^3$
10	3.16	80	$10^4$
15	5.62	100	$10^5$
20	10.00	120	$10^6$

<sup>2</sup> See Appendix D for more information regarding the decibel.

The key to plotting Eq. E.10 is to plot each term in the equation separately and then combine the separate plots graphically. The individual factors are easy to plot because they can be approximated in all cases by straight lines.

The plot of  $20 \log_{10} K_o$  is a horizontal straight line because  $K_o$  is not a function of frequency. The value of this term is positive for  $K_o > 1$ , zero for  $K_o = 1$ , and negative for  $K_o < 1$ .

Two straight lines approximate the plot of  $20 \log_{10}|1 + j\omega/z_1|$ . For small values of  $\omega$ , the magnitude  $|1 + j\omega/z_1|$  is approximately 1, and therefore

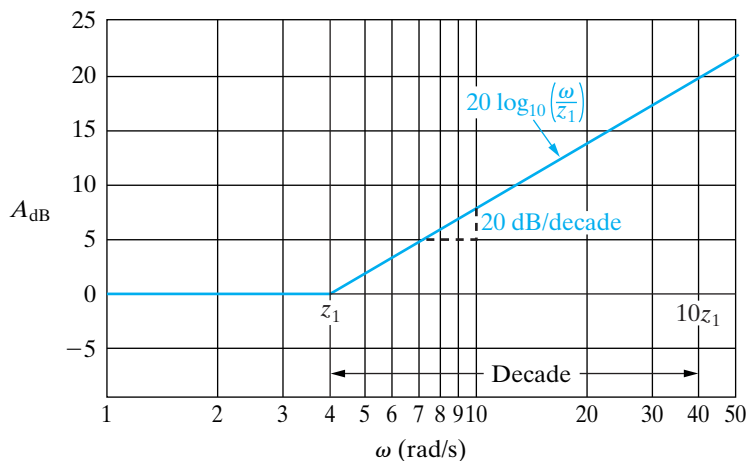
$$20 \log_{10}|1 + j\omega/z_1| \rightarrow 0 \quad \text{as } \omega \rightarrow 0. \quad (\text{E.11})$$

For large values of  $\omega$ , the magnitude  $|1 + j\omega/z_1|$  is approximately  $\omega/z_1$ , and therefore

$$20 \log_{10}|1 + j\omega/z_1| \rightarrow 20 \log_{10}(\omega/z_1) \quad \text{as } \omega \rightarrow \infty. \quad (\text{E.12})$$

On a log frequency scale,  $20 \log_{10}(\omega/z_1)$  is a straight line with a slope of 20 dB/decade (a decade is a 10-to-1 change in frequency). This straight line intersects the 0 dB axis at  $\omega = z_1$ . This value of  $\omega$  is called the **corner frequency**. Thus, on the basis of Eqs. E.11 and E.12, two straight lines can approximate the amplitude plot of a first-order zero, as shown in Fig. E.1.

The plot of  $-20 \log_{10} \omega$  is a straight line having a slope of  $-20$  dB/decade that intersects the 0 dB axis at  $\omega = 1$ . Two straight lines approximate the plot of  $-20 \log_{10}|1 + j\omega/p_1|$ . Here the two straight lines



**Figure E.1** ▲ A straight-line approximation of the amplitude plot of a first-order zero.

intersect on the 0 dB axis at  $\omega = p_1$ . For large values of  $\omega$ , the straight line  $20 \log_{10}(\omega/p_1)$  has a slope of  $-20$  dB/decade. Figure E.2 shows the straight-line approximation of the amplitude plot of a first-order pole.

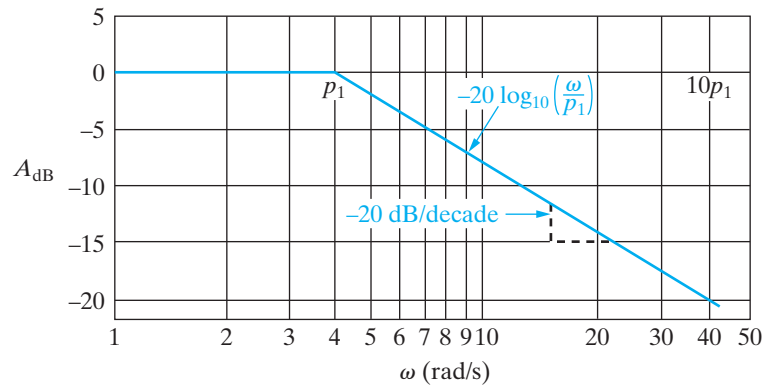


Figure E.2 ▲ A straight-line approximation of the amplitude plot of a first-order pole.

Figure E.3 shows a plot of Eq. E.10 for  $K_o = \sqrt{10}$ ,  $z_1 = 0.1$  rad/s, and  $p_1 = 5$  rad/s. Each term in Eq. E.10 is labeled on Fig. E.3, so you can verify that the individual terms sum to create the resultant plot, labeled  $20 \log_{10}|H(j\omega)|$ .

Example E.1 illustrates the construction of a straight-line amplitude plot for a transfer function characterized by first-order poles and zeros.

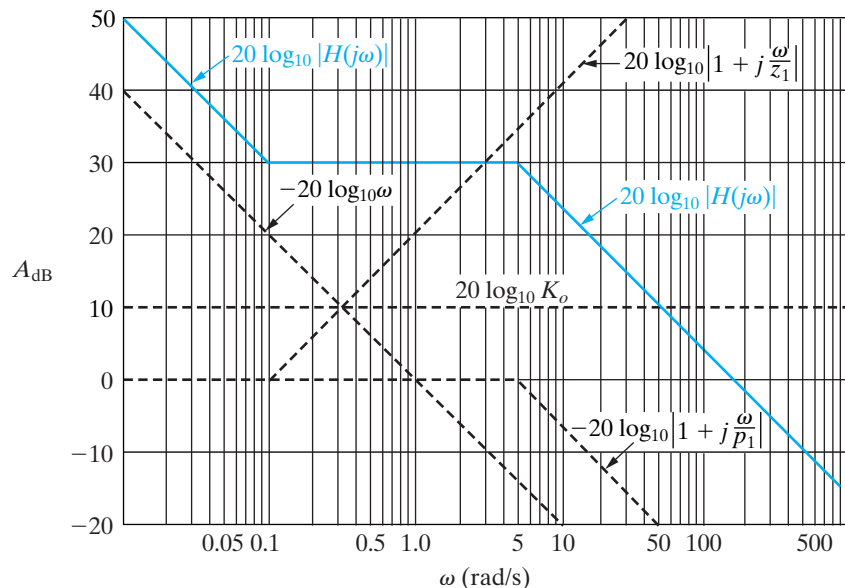
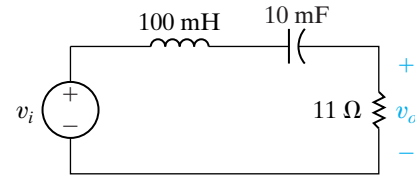


Figure E.3 ▲ A straight-line approximation of the amplitude plot for Eq. E.10.

**Example E.1**

For the circuit in Fig. E.4:

- Compute the transfer function,  $H(s)$ .
- Construct a straight-line approximation of the Bode amplitude plot.
- Calculate  $20 \log_{10}|H(j\omega)|$  at  $\omega = 50$  rad/s and  $\omega = 1000$  rad/s.
- Plot the values computed in (c) on the straight-line graph; and
- Suppose that  $v_i(t) = 5 \cos(500t + 15^\circ)$  V, and then use the Bode plot you constructed to predict the amplitude of  $v_o(t)$  in the steady state.



**Figure E.4** ▲ The circuit for Example E.1.

c) We have

$$\begin{aligned} H(j50) &= \frac{0.11(j50)}{(1 + j5)(1 + j0.5)} \\ &= 0.9648 \angle -15.25^\circ, \end{aligned}$$

$$20 \log_{10}|H(j50)| = 20 \log_{10} 0.9648$$

$$= -0.311 \text{ dB};$$

$$H(j1000) = \frac{0.11(j1000)}{(1 + j100)(1 + j10)}$$

$$= 0.1094 \angle -83.72^\circ;$$

$$20 \log_{10} 0.1094 = -19.22 \text{ dB}.$$

**Solution**

- Transforming the circuit in Fig. E.4 into the  $s$ -domain and then using  $s$ -domain voltage division gives

$$H(s) = \frac{(R/L)s}{s^2 + (R/L)s + \frac{1}{LC}}.$$

Substituting the numerical values from the circuit, we get

$$H(s) = \frac{110s}{s^2 + 110s + 1000} = \frac{110s}{(s + 10)(s + 100)}.$$

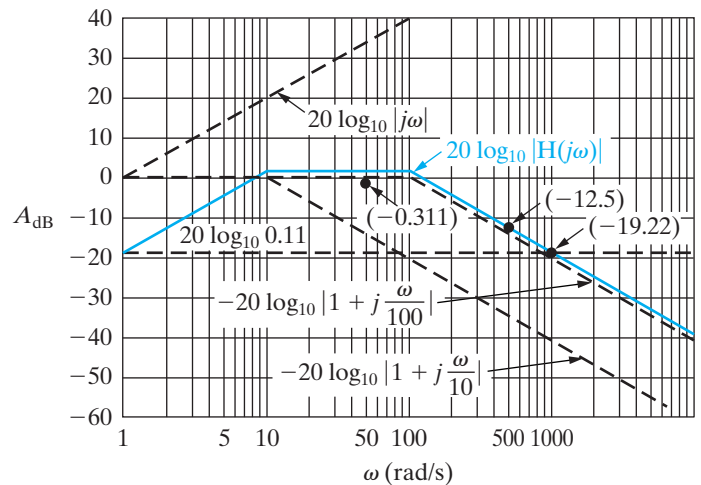
- We begin by writing  $H(j\omega)$  in standard form:

$$H(j\omega) = \frac{0.11 j\omega}{[1 + j(\omega/10)][1 + j(\omega/100)]}.$$

The expression for the amplitude of  $H(j\omega)$  in decibels is

$$\begin{aligned} A_{\text{dB}} &= 20 \log_{10}|H(j\omega)| \\ &= 20 \log_{10} 0.11 + 20 \log_{10}|j\omega| \\ &\quad - 20 \log_{10} \left| 1 + j \frac{\omega}{10} \right| - 20 \log_{10} \left| 1 + j \frac{\omega}{100} \right|. \end{aligned}$$

Figure E.5 shows the straight-line plot. Each term contributing to the overall amplitude is identified.



**Figure E.5** ▲ The straight-line amplitude plot for the transfer function of the circuit in Fig. E.4.

d) See Fig. E.5.

e) As we can see from the Bode plot in Fig. E.5, the value of  $A_{\text{dB}}$  at  $\omega = 500$  rad/s is approximately  $-12.5$  dB. Therefore,

$$|A| = 10^{(-12.5/20)} = 0.24$$

and

$$V_{mo} = |A|V_{mi} = (0.24)(5) = 1.19 \text{ V.}$$

We can compute the actual value of  $|H(j\omega)|$  by substituting  $\omega = 500$  into the equation for  $|H(j\omega)|$ :

$$H(j500) = \frac{0.11(j500)}{(1 + j50)(1 + j5)} = 0.22 \angle -77.54^\circ.$$

Thus, the actual output voltage magnitude for the specified signal source at a frequency of 500 rad/s is

$$V_{mo} = |A|V_{mi} = (0.22)(5) = 1.1 \text{ V.}$$

### E.3 More Accurate Amplitude Plots

We can make the straight-line plots for first-order poles and zeros more accurate by correcting the amplitude values at the corner frequency, one half the corner frequency, and twice the corner frequency. At the corner frequency, the actual value in decibels is

$$\begin{aligned} A_{\text{dB}_c} &= \pm 20 \log_{10} |1 + j1| \\ &= \pm 20 \log_{10} \sqrt{2} \\ &\approx \pm 3 \text{ dB.} \end{aligned} \tag{E.13}$$

The actual value at one half the corner frequency is

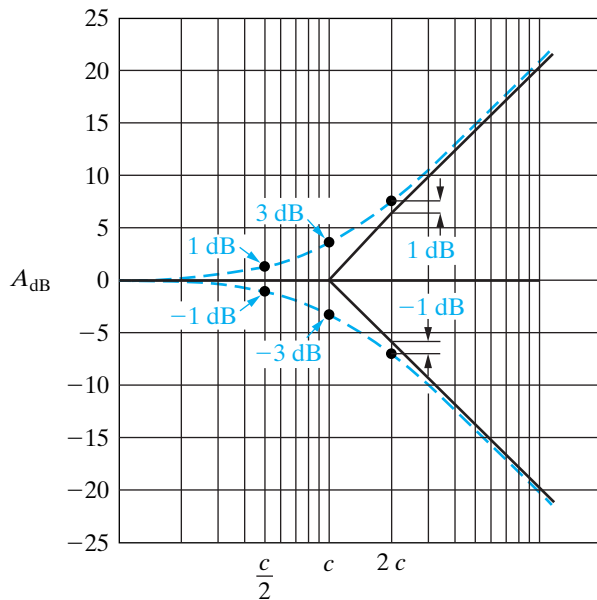
$$\begin{aligned} A_{\text{dB}_{c/2}} &= \pm 20 \log_{10} \left| 1 + j\frac{1}{2} \right| \\ &= \pm 20 \log_{10} \sqrt{5/4} \\ &\approx \pm 1 \text{ dB.} \end{aligned} \tag{E.14}$$

At twice the corner frequency, the actual value in decibels is

$$\begin{aligned} A_{\text{dB}_{2c}} &= \pm 20 \log_{10} |1 + j2| \\ &= \pm 20 \log_{10} \sqrt{5} \\ &\approx \pm 7 \text{ dB.} \end{aligned} \tag{E.15}$$

In Eqs. E.13–E.15, the plus sign applies to a first-order zero, and the minus sign applies to a first-order pole. The straight-line approximation of the amplitude plot gives 0 dB at the corner and one half the corner frequencies, and  $\pm 6$  dB at twice the corner frequency. Hence the corrections are  $\pm 3$  dB at the corner frequency and  $\pm 1$  dB at both one half the corner frequency and twice the corner frequency. Figure E.6 summarizes these corrections.

A 2-to-1 change in frequency is called an **octave**. A slope of 20 dB/decade is equivalent to 6.02 dB/octave, which for graphical purposes is equivalent to 6 dB/octave. Thus the corrections enumerated correspond to one octave below and one octave above the corner frequency.



**Figure E.6** ▲ Corrected amplitude plots for a first-order zero and pole.

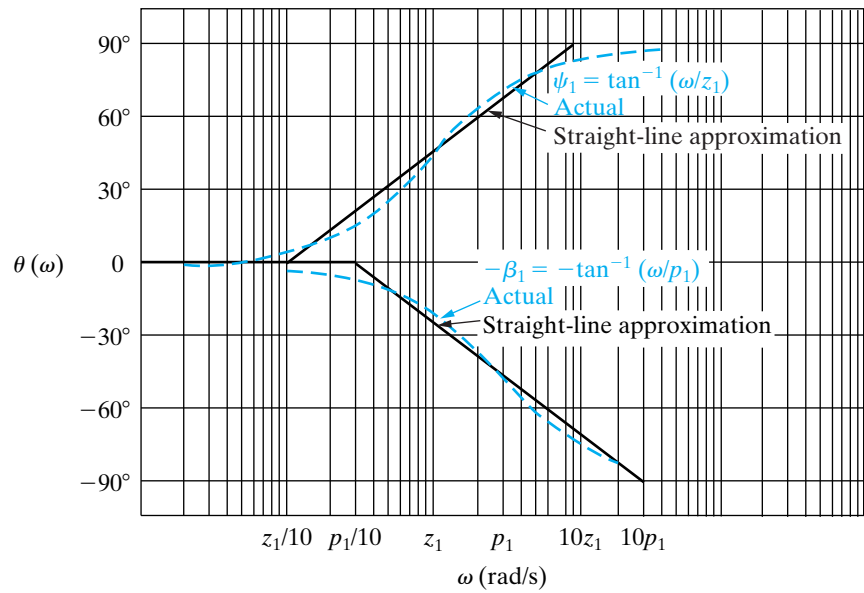
If the poles and zeros of  $H(s)$  are well separated, inserting these corrections into the overall amplitude plot and achieving a reasonably accurate curve is relatively easy. However, if the poles and zeros are close together, the overlapping corrections are difficult to evaluate, and you're better off using the straight-line plot as a first estimate of the amplitude characteristic. Then use a computer to refine the calculations in the frequency range of interest.

## E.4 Straight-Line Phase Angle Plots

We can also make phase angle plots by using straight-line approximations. The phase angle associated with the constant  $K_o$  is zero, and the phase angle associated with a first-order zero or pole at the origin is a constant  $\pm 90^\circ$ . For a first-order zero or pole not at the origin, the straight-line approximations are as follows:

- For frequencies less than one tenth the corner frequency, the phase angle is assumed to be zero.
- For frequencies greater than 10 times the corner frequency, the phase angle is assumed to be  $\pm 90^\circ$ .
- Between one tenth the corner frequency and 10 times the corner frequency, the phase angle plot is a straight line that goes through  $0^\circ$  at one-tenth the corner frequency,  $\pm 45^\circ$  at the corner frequency, and  $\pm 90^\circ$  at 10 times the corner frequency.

In all these cases, the plus sign applies to the first-order zero and the minus sign to the first-order pole. Figure E.7 depicts the straight-line approximation for a first-order zero and pole. The dashed curves show the exact variation of the phase angle as the frequency varies. Note how closely the

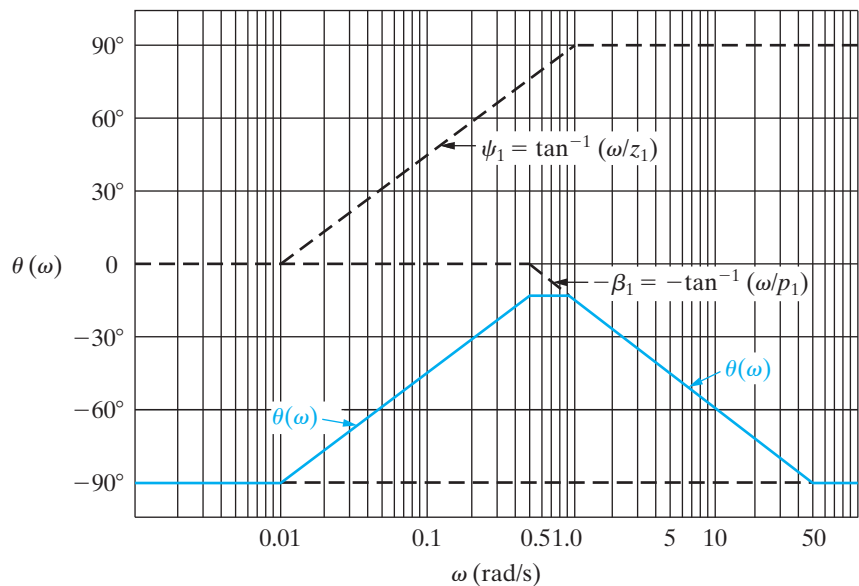


**Figure E.7** ▲ Phase angle plots for a first-order zero and pole.

straight-line plot approximates the actual variation in phase angle. The maximum deviation between the straight-line plot and the actual plot is approximately  $6^\circ$ .

Figure E.8 depicts the straight-line approximation of the phase angle of the transfer function given by Eq. B.1. Equation B.6 gives the equation for the phase angle; the plot corresponds to  $z_1 = 0.1$  rad/s, and  $p_1 = 5$  rad/s.

An illustration of a phase angle plot using a straight-line approximation is given in Example E.2.



**Figure E.8** ▲ A straight-line approximation of the phase angle plot for Eq. B.1.

**Example E.2**

- Make a straight-line phase angle plot for the transfer function in Example E.1.
- Compute the phase angle  $\theta(\omega)$  at  $\omega = 50, 500,$  and  $1000$  rad/s.
- Plot the values of (b) on the diagram of (a).
- Using the results from Example E.1(e) and (b) of this example, compute the steady-state output voltage if the source voltage is given by  $v_i(t) = 10 \cos(500t - 25^\circ)$  V.

**Solution**

- From Example E.1,

$$H(j\omega) = \frac{0.11(j\omega)}{[1 + j(\omega/10)][1 + j(\omega/100)]}$$

$$= \frac{0.11|j\omega|}{|1 + j(\omega/10)||1 + j(\omega/100)|} \angle(\psi_1 - \beta_1 - \beta_2).$$

Therefore,

$$\theta(\omega) = \psi_1 - \beta_1 - \beta_2,$$

where  $\psi_1 = 90^\circ$ ,  $\beta_1 = \tan^{-1}(\omega/10)$ , and  $\beta_2 = \tan^{-1}(\omega/100)$ . Figure E.9 depicts the straight-line approximation of  $\theta(\omega)$ .

- We have

$$H(j50) = 0.96 \angle -15.25^\circ,$$

$$H(j500) = 0.22 \angle -77.54^\circ,$$

$$H(j1000) = 0.11 \angle -83.72^\circ.$$

Thus,

$$\theta(j50) = -15.25^\circ,$$

$$\theta(j500) = -77.54^\circ,$$

and

$$\theta(j1000) = -83.72^\circ.$$

- See Fig. E.9.

- We have

$$V_{mo} = |H(j500)|V_{mi}$$

$$= (0.22)(10)$$

$$= 2.2 \text{ V},$$

and

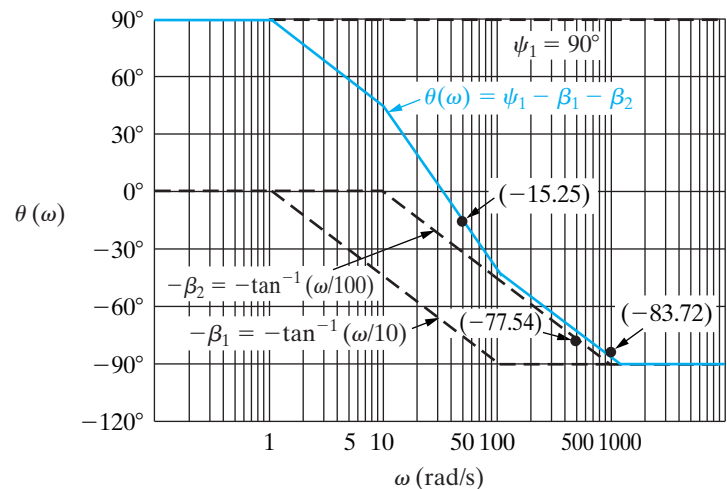
$$\theta_o = \theta(\omega) + \theta_i$$

$$= -77.54^\circ - 25^\circ$$

$$= -102.54^\circ.$$

Thus,

$$v_o(t) = 2.2 \cos(500t - 102.54^\circ) \text{ V}.$$



**Figure E.9** ▲ A straight-line approximation of  $\theta(\omega)$  for Example E.2.

## E.5 Bode Diagrams: Complex Poles and Zeros

Complex poles and zeros in the expression for  $H(s)$  require special attention when you make amplitude and phase angle plots. Let's focus on the contribution that a pair of complex poles makes to the amplitude and phase angle plots. Once you understand the rules for handling complex poles, their application to a pair of complex zeros becomes apparent.



The complex poles and zeros of  $H(s)$  always appear in conjugate pairs. The first step in making either an amplitude or a phase angle plot of a transfer function that contains complex poles is to combine the conjugate pair into a single quadratic term. Thus, for

$$H(s) = \frac{K}{(s + \alpha - j\beta)(s + \alpha + j\beta)}, \quad (\text{E.16})$$

we first rewrite the product  $(s + \alpha - j\beta)(s + \alpha + j\beta)$  as

$$(s + \alpha)^2 + \beta^2 = s^2 + 2\alpha s + \alpha^2 + \beta^2. \quad (\text{E.17})$$

When making Bode diagrams, we write the quadratic term in a more convenient form:

$$s^2 + 2\alpha s + \alpha^2 + \beta^2 = s^2 + 2\zeta\omega_n s + \omega_n^2. \quad (\text{E.18})$$

A direct comparison of the two forms shows that

$$\omega_n^2 = \alpha^2 + \beta^2 \quad (\text{E.19})$$

and

$$\zeta\omega_n = \alpha. \quad (\text{E.20})$$

The term  $\omega_n$  is the corner frequency of the quadratic factor, and  $\zeta$  is the damping coefficient of the quadratic term. The critical value of  $\zeta$  is 1. If  $\zeta < 1$ , the roots of the quadratic factor are complex, and we use Eq. E.18 to represent the complex poles. If  $\zeta \geq 1$ , we factor the quadratic factor into  $(s + p_1)(s + p_2)$  and then plot amplitude and phase in accordance with the discussion previously. Assuming that  $\zeta < 1$ , we rewrite Eq. E.16 as

$$H(s) = \frac{K}{s^2 + 2\zeta\omega_n s + \omega_n^2}. \quad (\text{E.21})$$

We then write Eq. E.21 in standard form by dividing through by the poles and zeros. For the quadratic term, we divide through by  $\omega_n$ , so

$$H(s) = \frac{K}{\omega_n^2} \frac{1}{1 + (s/\omega_n)^2 + 2\zeta(s/\omega_n)}, \quad (\text{E.22})$$

from which

$$H(j\omega) = \frac{K_o}{1 - (\omega^2/\omega_n^2) + j(2\zeta\omega/\omega_n)}, \quad (\text{E.23})$$

where

$$K_o = \frac{K}{\omega_n^2}.$$

Before discussing the amplitude and phase angle diagrams associated with Eq. E.23, for convenience we replace the ratio  $\omega/\omega_n$  by a new variable,  $u$ . Then

$$H(j\omega) = \frac{K_o}{1 - u^2 + j2\zeta u}. \quad (\text{E.24})$$

Now we write  $H(j\omega)$  in polar form:

$$H(j\omega) = \frac{K_o}{|(1 - u^2) + j2\zeta u| \angle \beta_1}, \quad (\text{E.25})$$

from which

$$\begin{aligned} A_{\text{dB}} &= 20 \log_{10}|H(j\omega)| \\ &= 20 \log_{10}K_o - 20 \log_{10}|(1 - u^2) + j2\zeta u|, \end{aligned} \quad (\text{E.26})$$

and

$$\theta(\omega) = -\beta_1 = -\tan^{-1} \frac{2\zeta u}{1 - u^2}. \quad (\text{E.27})$$

## E.6 Amplitude Plots

The quadratic factor contributes to the amplitude of  $H(j\omega)$  by means of the term  $-20 \log_{10}|1 - u^2 + j2\zeta u|$ . Because  $u = \omega/\omega_n$ ,  $u \rightarrow 0$  as  $\omega \rightarrow 0$ , and  $u \rightarrow \infty$  as  $\omega \rightarrow \infty$ . To see how the term behaves as  $\omega$  ranges from 0 to  $\infty$ , we note that

$$\begin{aligned} -20 \log_{10}|(1 - u^2) + j2\zeta u| &= -20 \log_{10} \sqrt{(1 - u^2)^2 + 4\zeta^2 u^2} \\ &= -10 \log_{10}[u^4 + 2u^2(2\zeta^2 - 1) + 1], \end{aligned} \quad (\text{E.28})$$

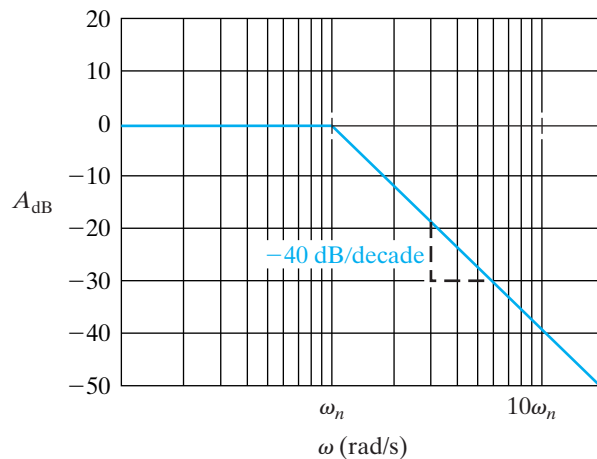
as  $u \rightarrow 0$ ,

$$-10 \log_{10}[u^4 + 2u^2(2\zeta^2 - 1) + 1] \rightarrow 0, \quad (\text{E.29})$$

and as  $u \rightarrow \infty$ ,

$$-10 \log_{10}[u^4 + 2u^2(2\zeta^2 - 1) + 1] \rightarrow -40 \log_{10} u. \quad (\text{E.30})$$

From Eqs. E.29 and E.30, we conclude that the approximate amplitude plot consists of two straight lines. For  $\omega < \omega_n$ , the straight line lies along the 0 dB axis, and for  $\omega > \omega_n$ , the straight line has a slope of  $-40$  dB/decade. These two straight lines join on the 0 dB axis at  $u = 1$  or  $\omega = \omega_n$ . Figure E.10 shows the straight-line approximation for a quadratic factor with  $\zeta < 1$ .



**Figure E.10** ▲ The amplitude plot for a pair of complex poles.

## E.7 Correcting Straight-Line Amplitude Plots

Correcting the straight-line amplitude plot for a pair of complex poles is not as easy as correcting a first-order real pole, because the corrections depend on the damping coefficient  $\zeta$ . Figure E.11 shows the effect of  $\zeta$  on the amplitude plot. Note that as  $\zeta$  becomes very small, a large peak in the amplitude occurs in the neighborhood of the corner frequency  $\omega_n(u = 1)$ . When  $\zeta \geq 1/\sqrt{2}$ , the corrected amplitude plot lies entirely below the straight-line approximation. For sketching purposes, the straight-line amplitude plot can be corrected by locating four points on the actual curve. These four points correspond to (1) one half the corner frequency, (2) the frequency at which the amplitude reaches its peak value, (3) the corner frequency, and (4) the frequency at which the amplitude is zero. Figure E.12 shows these four points.

At one half the corner frequency (point 1), the actual amplitude is

$$A_{\text{dB}}(\omega_n/2) = -10 \log_{10}(\zeta^2 + 0.5625). \quad (\text{E.31})$$

The amplitude peaks (point 2) at a frequency of

$$\omega_p = \omega_n \sqrt{1 - 2\zeta^2}, \quad (\text{E.32})$$

and it has a peak amplitude of

$$A_{\text{dB}}(\omega_p) = -10 \log_{10}[4\zeta^2(1 - \zeta^2)]. \quad (\text{E.33})$$

At the corner frequency (point 3), the actual amplitude is

$$A_{\text{dB}}(\omega_n) = -20 \log_{10}2\zeta. \quad (\text{E.34})$$

The corrected amplitude plot crosses the 0 dB axis (point 4) at

$$\omega_o = \omega_n \sqrt{2(1 - 2\zeta^2)} = \sqrt{2}\omega_p. \quad (\text{E.35})$$

The derivations of Eqs. E.31, E.34, and E.35 follow from Eq. E.28. Evaluating Eq. E.28 at  $u = 0.5$  and  $u = 1.0$ , respectively, yields Eqs. E.31 and E.34. Equation E.35 corresponds to finding the value of  $u$  that makes  $u^4 + 2u^2(2\zeta^2 - 1) + 1 = 1$ . The derivation of Eq. E.32 requires differentiating Eq. E.28 with respect to  $u$  and then finding the value of  $u$  where the derivative is zero. Equation E.33 is the evaluation of Eq. E.28 at the value of  $u$  found in Eq. E.32.

Example E.3 illustrates the amplitude plot for a transfer function with a pair of complex poles.

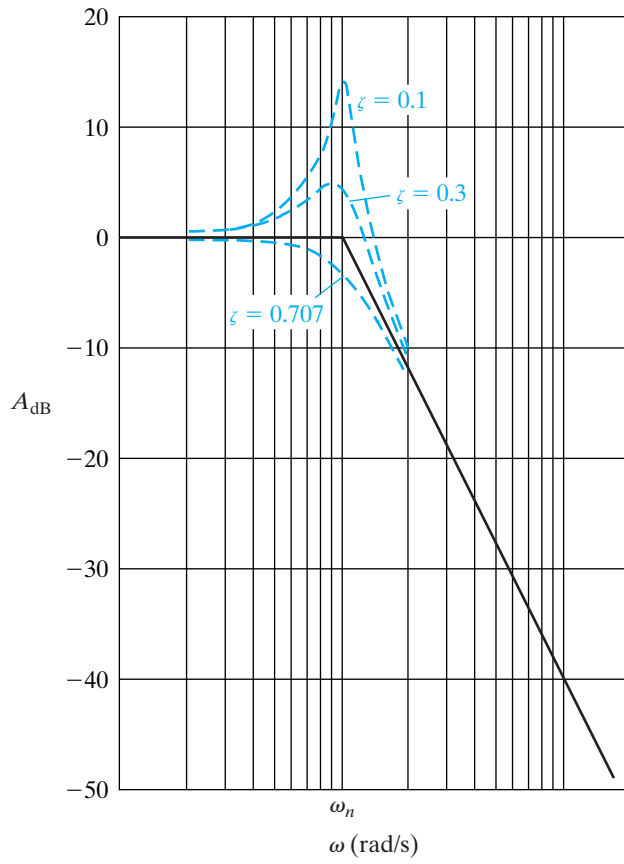


Figure E.11 ▲ The effect of  $\zeta$  on the amplitude plot.

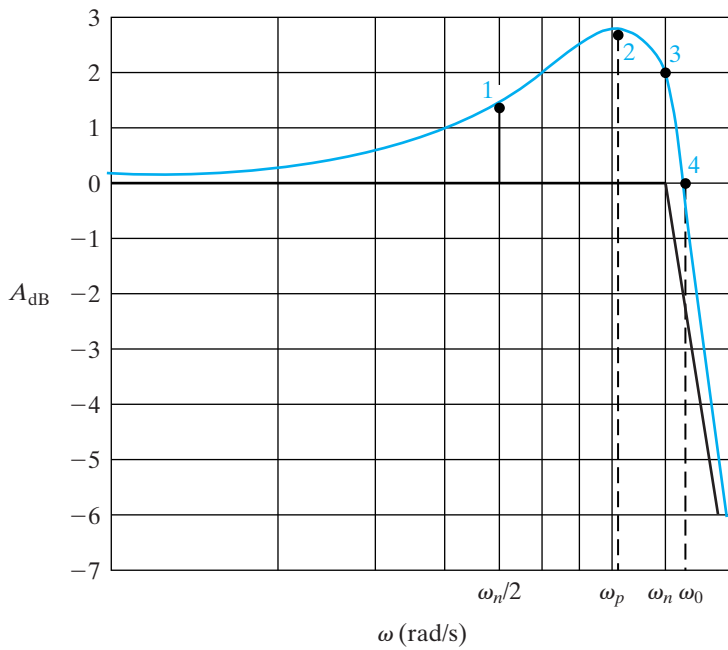
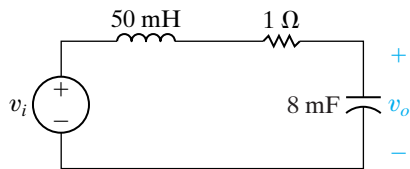


Figure E.12 ▲ Four points on the corrected amplitude plot for a pair of complex poles.

**Example E.3**

Compute the transfer function for the circuit shown in Fig. E.13.

- What is the value of the corner frequency in radians per second?
- What is the value of  $K_o$ ?
- What is the value of the damping coefficient?
- Make a straight-line amplitude plot ranging from 10 to 500 rad/s.
- Calculate and sketch the actual amplitude in decibels at  $\omega_n/2$ ,  $\omega_p$ ,  $\omega_n$ , and  $\omega_o$ .
- From the straight-line amplitude plot, describe the type of filter represented by the circuit in Fig. E.13 and estimate its cutoff frequency,  $\omega_c$ .



**Figure E.13** ▲ The circuit for Example E.3.

**Solution**

Transform the circuit in Fig. E.13 to the  $s$ -domain and then use  $s$ -domain voltage division to get

$$H(s) = \frac{\frac{1}{LC}}{s^2 + \left(\frac{R}{L}\right)s + \frac{1}{LC}}.$$

Substituting the component values,

$$H(s) = \frac{2500}{s^2 + 20s + 2500}.$$

- From the expression for  $H(s)$ ,  $\omega_n^2 = 2500$ ; therefore,  $\omega_n = 50$  rad/s.
- By definition,  $K_o$  is  $2500/\omega_n^2$ , or 1.
- The coefficient of  $s$  equals  $2\zeta\omega_n$ ; therefore

$$\zeta = \frac{20}{2\omega_n} = 0.20.$$

d) See Fig. E.14.

e) The actual amplitudes are

$$A_{dB}(\omega_n/2) = -10 \log_{10}(0.6025) = 2.2 \text{ dB},$$

$$\omega_p = 50\sqrt{0.92} = 47.96 \text{ rad/s},$$

$$A_{dB}(\omega_p) = -10 \log_{10}(0.16)(0.96) = 8.14 \text{ dB},$$

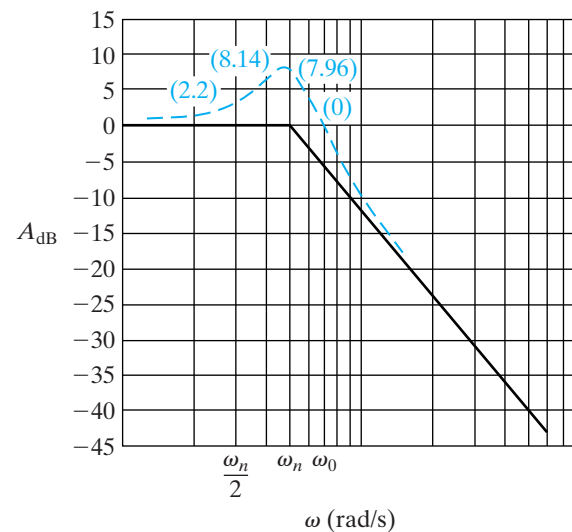
$$A_{dB}(\omega_n) = -20 \log_{10}(0.4) = 7.96 \text{ dB},$$

$$\omega_o = \sqrt{2}\omega_p = 67.82 \text{ rad/s},$$

$$A_{dB}(\omega_o) = 0 \text{ dB}.$$

Figure E.14 shows the corrected plot.

- It is clear from the amplitude plot in Fig. E.14 that this circuit acts as a low-pass filter. At the cutoff frequency, the magnitude of the transfer function,  $|H(j\omega_c)|$ , is 3 dB less than the maximum magnitude. From the corrected plot, the cutoff frequency appears to be about 55 rad/s, almost the same as that predicted by the straight-line Bode diagram.



**Figure E.14** ▲ The amplitude plot for Example E.3.

## E.8 Phase Angle Plots

The phase angle plot for a pair of complex poles is a plot of Eq. E.27. The phase angle is zero at zero frequency and is  $-90^\circ$  at the corner frequency. It approaches  $-180^\circ$  as  $\omega(u)$  becomes large. As in the case of the amplitude plot,  $\zeta$  is important in determining the exact shape of the phase angle plot. For small values of  $\zeta$ , the phase angle changes rapidly in the vicinity of the corner frequency. Figure E.15 shows the effect of  $\zeta$  on the phase angle plot.

We can also make a straight-line approximation of the phase angle plot for a pair of complex poles. We do so by drawing a line tangent to the phase angle curve at the corner frequency and extending this line until it intersects with the  $0^\circ$  and  $-180^\circ$  lines. The line tangent to the phase angle curve at  $-90^\circ$  has a slope of  $-2.3/\zeta$  rad/decade ( $-132/\zeta$  degrees/decade), and it intersects the  $0^\circ$  and  $-180^\circ$  lines at  $u_1 = 4.81^{-\zeta}$  and  $u_2 = 4.81^\zeta$ , respectively. Figure E.16 depicts the straight-line approximation for  $\zeta = 0.3$  and shows the actual phase angle plot. Comparing the straight-line approximation to the actual curve indicates that the approximation is reasonable in the vicinity of the corner frequency. However, in the neighborhood of  $u_1$  and  $u_2$ , the error is quite large. In Example E.4, we summarize our discussion of Bode diagrams.

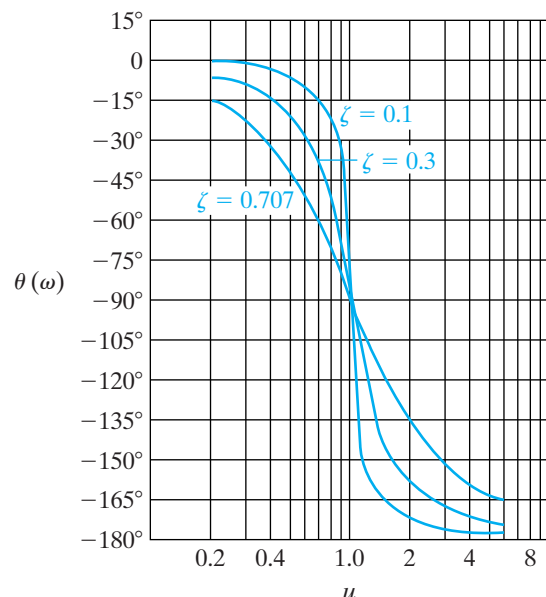


Figure E.15 ▲ The effect of  $\zeta$  on the phase angle plot.

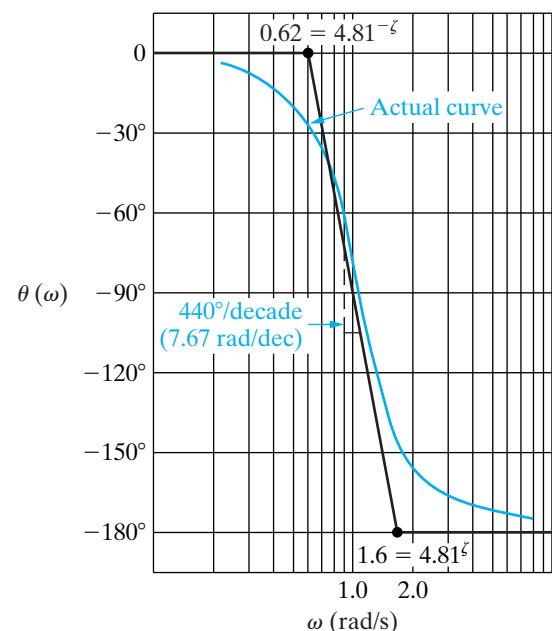
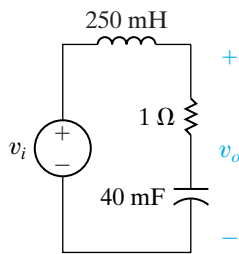


Figure E.16 ▲ A straight-line approximation of the phase angle for a pair of complex poles.

**Example E.4**

- Compute the transfer function for the circuit shown in Fig. E.17.
- Make a straight-line amplitude plot of  $20 \log_{10}|H(j\omega)|$ .
- Use the straight-line amplitude plot to determine the type of filter represented by this circuit and then estimate its cutoff frequency.
- What is the actual cutoff frequency?
- Make a straight-line phase angle plot of  $H(j\omega)$ .
- What is the value of  $\theta(\omega)$  at the cutoff frequency from (c)?
- What is the actual value of  $\theta(\omega)$  at the cutoff frequency?



**Figure E.17** ▲ The circuit for Example E.4.

**Solution**

- Transform the circuit in Fig. E.17 to the  $s$ -domain and then perform  $s$ -domain voltage division to get

$$H(s) = \frac{\frac{R}{L}s + \frac{1}{LC}}{s^2 + \frac{R}{L}s + \frac{1}{LC}}$$

Substituting the component values from the circuit gives

$$H(s) = \frac{4(s + 25)}{s^2 + 4s + 100}$$

- The first step in making Bode diagrams is to put  $H(j\omega)$  in standard form. Because  $H(s)$  contains a quadratic factor, we first check the value of  $\zeta$ . We find that  $\zeta = 0.2$  and  $\omega_n = 10$ , so

$$H(s) = \frac{s/25 + 1}{1 + (s/10)^2 + 0.4(s/10)},$$

from which

$$H(j\omega) = \frac{|1 + j\omega/25| \angle \psi_1}{|1 - (\omega/10)^2 + j0.4(\omega/10)| \angle \beta_1}$$

Note that for the quadratic factor,  $u = \omega/10$ . The amplitude of  $H(j\omega)$  in decibels is

$$A_{\text{dB}} = 20 \log_{10}|1 + j\omega/25| - 20 \log_{10} \left[ \left| 1 - \left(\frac{\omega}{10}\right)^2 + j0.4\left(\frac{\omega}{10}\right) \right| \right],$$

and the phase angle is

$$\theta(\omega) = \psi_1 - \beta_1,$$

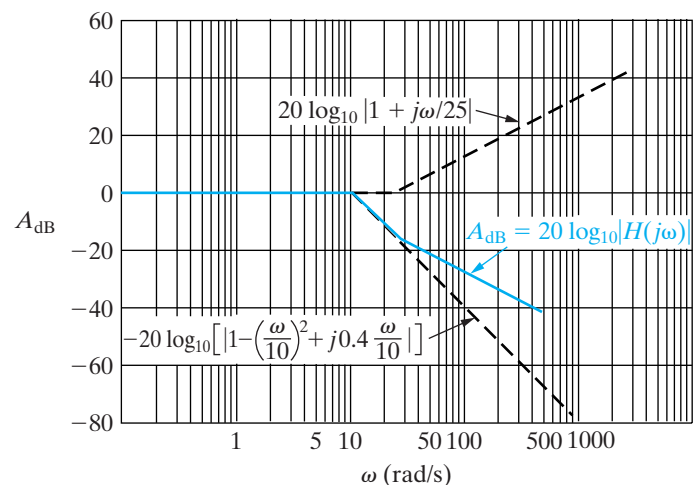
where

$$\psi_1 = \tan^{-1}(\omega/25),$$

$$\beta_1 = \tan^{-1} \frac{0.4(\omega/10)}{1 - (\omega/10)^2}.$$

Figure E.18 shows the amplitude plot.

- From the straight-line amplitude plot in Fig. E.18, this circuit acts as a low-pass filter. At the cutoff frequency, the amplitude of  $H(j\omega)$  is 3 dB less than the amplitude in the passband. From the plot, we predict that the cutoff frequency is approximately 13 rad/s.



**Figure E.18** ▲ The amplitude plot for Example E.4.

- d) To solve for the actual cutoff frequency, replace  $s$  with  $j\omega$  in  $H(s)$ , compute the expression for  $|H(j\omega)|$ , set  $|H(j\omega_c)| = (1/\sqrt{2}) H_{\max} = 1/\sqrt{2}$ , and solve for  $\omega_c$ . First,

$$H(j\omega) = \frac{4(j\omega) + 100}{(j\omega)^2 + 4(j\omega) + 100}.$$

Then,

$$|H(j\omega_c)| = \frac{\sqrt{(4\omega_c)^2 + 100^2}}{\sqrt{(100 - \omega_c^2)^2 + (4\omega_c)^2}} = \frac{1}{\sqrt{2}}.$$

Solving for  $\omega_c$  gives us

$$\omega_c = 16 \text{ rad/s.}$$

- e) Figure E.19 shows the phase angle plot. Note that the straight-line segment of  $\theta(\omega)$  between 1.0 and 2.5 rad/s does not have the same slope as the segment between 2.5 and 100 rad/s.
- f) From the phase angle plot in Fig. E.19, we estimate the phase angle at the cutoff frequency of 16 rad/s to be  $-65^\circ$ .
- g) We can compute the exact phase angle at the cutoff frequency by substituting  $s = j16$  into the transfer function  $H(s)$ :

$$H(j16) = \frac{4(j16 + 25)}{(j16)^2 + 4(j16) + 100}.$$

Computing the phase angle, we see

$$\theta(\omega_c) = \theta(j16) = -125.0^\circ.$$

Note the large error in the predicted angle. In general, straight-line phase angle plots do not give satisfactory results in the frequency band where the phase angle is changing. The straight-line phase angle plot is useful only in predicting the general behavior of the phase angle, not in estimating actual phase angle values at particular frequencies.

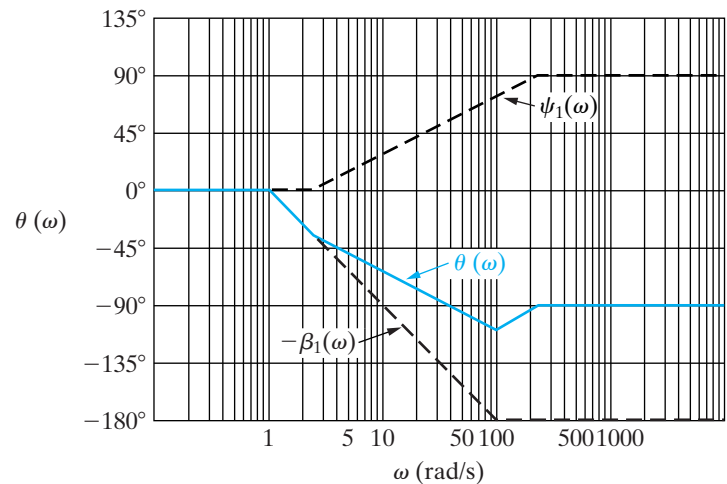


Figure E.19 ▲ The phase angle plot for Example E.4.



*This page intentionally left blank*

# F An Abbreviated Table of Trigonometric Identities

$$1. \sin(\alpha \pm \beta) = \sin\alpha\cos\beta \pm \cos\alpha\sin\beta$$

$$2. \cos(\alpha \pm \beta) = \cos\alpha\cos\beta \mp \sin\alpha\sin\beta$$

$$3. \sin\alpha + \sin\beta = 2 \sin \frac{\alpha + \beta}{2} \cos \frac{\alpha - \beta}{2}$$

$$4. \sin\alpha - \sin\beta = 2 \cos \left( \frac{\alpha + \beta}{2} \right) \sin \left( \frac{\alpha - \beta}{2} \right)$$

$$5. \cos\alpha + \cos\beta = 2 \cos \left( \frac{\alpha + \beta}{2} \right) \cos \left( \frac{\alpha - \beta}{2} \right)$$

$$6. \cos\alpha - \cos\beta = -2 \sin \left( \frac{\alpha + \beta}{2} \right) \sin \left( \frac{\alpha - \beta}{2} \right)$$

$$7. 2 \sin\alpha \sin\beta = \cos(\alpha - \beta) - \cos(\alpha + \beta)$$

$$8. 2 \cos\alpha \cos\beta = \cos(\alpha - \beta) + \cos(\alpha + \beta)$$

$$9. 2 \sin\alpha \cos\beta = \sin(\alpha + \beta) + \sin(\alpha - \beta)$$

$$10. \sin 2\alpha = 2 \sin\alpha \cos\alpha$$

$$11. \cos 2\alpha = 2 \cos^2\alpha - 1 = 1 - 2 \sin^2\alpha$$

$$12. \cos^2\alpha = \frac{1}{2} + \frac{1}{2} \cos 2\alpha$$

$$13. \sin^2\alpha = \frac{1}{2} - \frac{1}{2} \cos 2\alpha$$

$$14. \tan(\alpha \pm \beta) = \frac{\tan\alpha \pm \tan\beta}{1 \mp \tan\alpha \tan\beta}$$

$$15. \tan 2\alpha = \frac{2 \tan\alpha}{1 - \tan^2\alpha}$$

*This page intentionally left blank*

# G An Abbreviated Table of Integrals

$$1. \int x e^{ax} dx = \frac{e^{ax}}{a^2} (ax - 1)$$

$$2. \int x^2 e^{ax} dx = \frac{e^{ax}}{a^3} (a^2 x^2 - 2ax + 2)$$

$$3. \int x \sin ax dx = \frac{1}{a^2} \sin ax - \frac{x}{a} \cos ax$$

$$4. \int x \cos ax dx = \frac{1}{a^2} \cos ax + \frac{x}{a} \sin ax$$

$$5. \int e^{ax} \sin bx dx = \frac{e^{ax}}{a^2 + b^2} (a \sin bx - b \cos bx)$$

$$6. \int e^{ax} \cos bx dx = \frac{e^{ax}}{a^2 + b^2} (a \cos bx + b \sin bx)$$

$$7. \int \frac{dx}{x^2 + a^2} = \frac{1}{a} \tan^{-1} \frac{x}{a}$$

$$8. \int \frac{dx}{(x^2 + a^2)^2} = \frac{1}{2a^2} \left( \frac{x}{x^2 + a^2} + \frac{1}{a} \tan^{-1} \frac{x}{a} \right)$$

$$9. \int \sin ax \sin bx dx = \frac{\sin(a-b)x}{2(a-b)} - \frac{\sin(a+b)x}{2(a+b)}, \quad a^2 \neq b^2$$

$$10. \int \cos ax \cos bx dx = \frac{\sin(a-b)x}{2(a-b)} + \frac{\sin(a+b)x}{2(a+b)}, \quad a^2 \neq b^2$$

$$11. \int \sin ax \cos bx dx = -\frac{\cos(a-b)x}{2(a-b)} - \frac{\cos(a+b)x}{2(a+b)}, \quad a^2 \neq b^2$$

$$12. \int \sin^2 ax dx = \frac{x}{2} - \frac{\sin 2ax}{4a}$$

$$13. \int \cos^2 ax dx = \frac{x}{2} + \frac{\sin 2ax}{4a}$$

$$14. \int_0^{\infty} \frac{a dx}{a^2 + x^2} = \begin{cases} \frac{\pi}{2}, & a > 0; \\ 0, & a = 0; \\ -\frac{\pi}{2}, & a < 0 \end{cases}$$

$$15. \int_0^{\infty} \frac{\sin ax}{x} dx = \begin{cases} \frac{\pi}{2}, & a > 0; \\ -\frac{\pi}{2}, & a < 0 \end{cases}$$

$$16. \int x^2 \sin ax dx = \frac{2x}{a^2} \sin ax - \frac{a^2 x^2 - 2}{a^3} \cos ax$$

$$17. \int x^2 \cos ax dx = \frac{2x}{a^2} \cos ax + \frac{a^2 x^2 - 2}{a^3} \sin ax$$

$$18. \int e^{ax} \sin^2 bx \, dx = \frac{e^{ax}}{a^2 + 4b^2} \left[ (a \sin bx - 2b \cos bx) \sin bx + \frac{2b^2}{a} \right]$$

$$19. \int e^{ax} \cos^2 bx \, dx = \frac{e^{ax}}{a^2 + 4b^2} \left[ (a \cos bx + 2b \sin bx) \cos bx + \frac{2b^2}{a} \right]$$

# H Common Standard Component Values

## Resistors (5% tolerance)[ $\Omega$ ]

10	100	1.0 k	10k	100k	1.0 M
	120	1.2 k	12 k	120 k	
15	150	1.5 k	15 k	150 k	1.5 M
	180	1.8 k	18 k	180 k	
22	220	2.2 k	22 k	220 k	2.2 M
	270	2.7 k	27 k	270 k	
33	330	3.3 k	33 k	330 k	3.3 M
	390	3.9 k	39 k	390 k	
47	470	4.7 k	47 k	470 k	4.7 M
	560	5.6 k	56 k	560 k	
68	680	6.8 k	68 k	680 k	6.8 M

## Capacitors

10 pF	22 pF	47 pF
100 pF	220 pF	470 pF
0.001 $\mu$ F	0.0022 $\mu$ F	0.0047 $\mu$ F
0.01 $\mu$ F	0.022 $\mu$ F	0.047 $\mu$ F
0.1 $\mu$ F	0.22 $\mu$ F	0.47 $\mu$ F
1 $\mu$ F	2.2 $\mu$ F	4.7 $\mu$ F
10 $\mu$ F	22 $\mu$ F	47 $\mu$ F
100 $\mu$ F	220 $\mu$ F	470 $\mu$ F

## Inductors

Value	Current Rating
10 $\mu$ H	3 A
100 $\mu$ H	0.91 A
1 mH	0.15 A
10 mH	0.04A

*This page intentionally left blank*



# Answers to Selected Problems

## Chapter 1

- 1.1 104.4 gigawatt-hours  
1.5 0.10 mm  
1.12 [a]  $-400$  W; power is being delivered by the box  
[b] Entering  
[c] Gaining  
1.19 [a] 937.5 mW  
[b] 1.875 mJ  
1.24 [a] 223.80 W  
[b] 4 J  
1.34  $\sum P_{\text{del}} = \sum P_{\text{abs}} = 2280$  W

## Chapter 2

- 2.6 [a] 20 V  
[b] 8 W (absorbed)  
2.12 [a]  $-16$  mA  
[b] 640 mW  
[c] 16 mA; 640 mW  
2.15  $100\ \Omega$  resistor  
2.19 [a] 1.2 A, 0.3 A  
[b] 120 V  
[c]  $\sum P_{\text{del}} = \sum P_{\text{abs}} = 180$  W  
2.29 [a] 20 A in parallel with  $5\ \Omega$   
[b] 320 W  
2.33 15 V, 1.4167 W  
2.42 1800 W, which is 1/2 the power for the circuit in Fig. 2.41

## Chapter 3

- 3.2 [a] 576 W, 288 W, 192 W, 384 W  
[b] 1440 W  
[c]  $\sum P_{\text{del}} = \sum P_{\text{abs}} = 1440$  W  
3.5 [a] 12 k $\Omega$ , 900  $\Omega$ , 30  $\Omega$ , 120  $\Omega$   
[b] 27 mW, 810 mW, 270 W, 108 mW  
3.12 [a] 66 V  
[b] 1.88 W, 1.32 W  
[c] 17,672  $\Omega$ , 12,408  $\Omega$   
3.14 [a] 1200  $\Omega$ , 300  $\Omega$   
[b] 1 W  
3.26 [a] 150 mA  
[b] 5.4 V  
[c] 3.6 V  
[d] 1 V  
3.34 7.5 A  
3.37 [a] 49,980  $\Omega$   
[b] 4980  $\Omega$   
[c] 230  $\Omega$   
[d] 5  $\Omega$   
3.51 [a] 1500  $\Omega$   
[b] 28.8 mA  
[c] 750  $\Omega$ , 276.48 mW  
[d] 1000  $\Omega$ , 92.16 mW  
3.60 [a] 80  $\Omega$   
[b] 279 W  
3.62 2.4 A, 72.576 W  
3.73 [a] 0.2, 0.75  
[b] 384, 200



## Chapter 4

- 4.2 [a] 9  
 [b] 4  
 [c] 4  
 [d] Bottom left-most mesh cannot be used; two meshes sharing dependent source must be combined
- 4.5 [a] 2  
 [b] 5  
 [c] 7  
 [d] 1, 4, 7
- 4.11 [a]  $-6.8$  A,  $2.7$  A,  $-9.5$  A,  $2.5$  A,  $-12$  A,  
 [b]  $3840$  W
- 4.13  $120$  V,  $96$  V
- 4.18  $750$  W
- 4.22 [a]  $-37.5$  V,  $75$  W  
 [b]  $-37.5$  V,  $75$  W  
 [c] Part (b), fewer equations
- 4.26  $-20$  V
- 4.32 [a]  $0.1$  A,  $0.3$  A,  $0.2$  A  
 [b]  $0.38$  A,  $0.02$  A,  $-0.36$  A
- 4.40  $2700$  W
- 4.43 [a]  $2$  mA  
 [b]  $304$  mW  
 [c]  $0.9$  mW
- 4.49  $525$  W
- 4.54 [a] Mesh current method  
 [b]  $4$  mW  
 [c] No  
 [d]  $200$  mW
- 4.62 [a]  $-0.85$  A  
 [b]  $-0.85$  A
- 4.68  $1$  mA down in parallel with  $3.75$  k $\Omega$
- 4.72 [a]  $51.3$  V  
 [b]  $-5\%$
- 4.79  $150$   $\Omega$
- 4.88  $2.5$   $\Omega$  and  $22.5$   $\Omega$
- 4.93 [a]  $50$  V  
 [b]  $250$  W
- 4.105  $39.583$  V,  $102.5$  V

## Chapter 5

- 5.5  $-1$  mA
- 5.11 [a]  $0 \leq \sigma \leq 0.40$   
 [b]  $556.25$   $\mu$ A
- 5.13  $0 \leq R_f \leq 60$  k $\Omega$
- 5.20 [a]  $10.54$  V  
 [b]  $-4.55$  V  $\leq v_g \leq 4.55$  V  
 [c]  $181.76$  k $\Omega$
- 5.27 [a]  $-15.1$  V  
 [b]  $34.3$  k $\Omega$   
 [c]  $250$  k $\Omega$
- 5.30 [a]  $16$  V  
 [b]  $-4.2$  V  $\leq v_b \leq 3.8$  V
- 5.34  $2994$   $\Omega \leq R_x \leq 3006$   $\Omega$
- 5.44 [a]  $-19.9844$   
 [b]  $736.1$   $\mu$ V  
 [c]  $5003.68$   $\Omega$   
 [d]  $-20$ ,  $0$ ,  $5000$   $\Omega$
- 5.49 [a]  $2$  k $\Omega$   
 [b]  $12$  m $\Omega$

## Chapter 6

6.2 [a]  $i = 0 \quad t \leq 0$   
 $i = 4t \text{ A} \quad 0 \leq t \leq 25 \text{ ms}$   
 $i = 0.2 - 4t \text{ A} \quad 25 \leq t \leq 50 \text{ ms}$   
 $i = 0 \quad 50 \text{ ms} \leq t$

[b]  $v = 0 \quad t < 0$   
 $v = 2 \text{ V} \quad 0 < t < 25 \text{ ms}$   
 $v = -2 \text{ V} \quad 25 < t < 50 \text{ ms}$   
 $v = 0 \quad 50 \text{ ms} < t$

$p = 0 \quad t \leq 0$   
 $p = 8t \text{ W} \quad 0 \leq t < 25 \text{ ms}$   
 $p = 8t - 0.4 \text{ W} \quad 25 < t \leq 50 \text{ ms}$   
 $p = 0 \quad 50 \text{ ms} \leq t$

$w = 0 \quad t \leq 0$   
 $w = 4t^2 \text{ J} \quad 0 \leq t \leq 25 \text{ ms}$   
 $w = 4t^2 - 0.4t + 10 \times 10^{-3} \text{ J} \quad 25 \leq t \leq 50 \text{ ms}$   
 $w = 0 \quad 50 \text{ ms} \leq t$

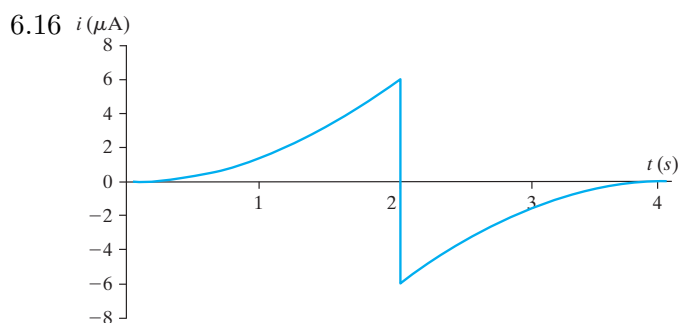
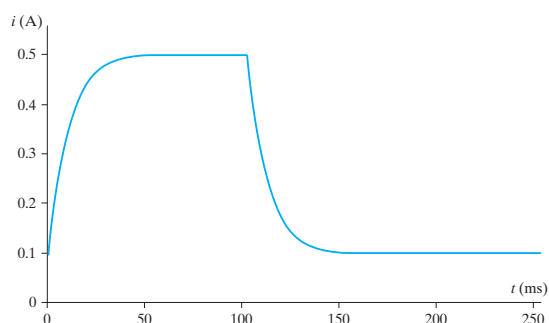
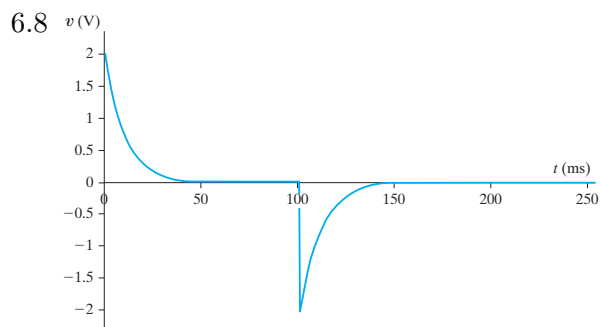
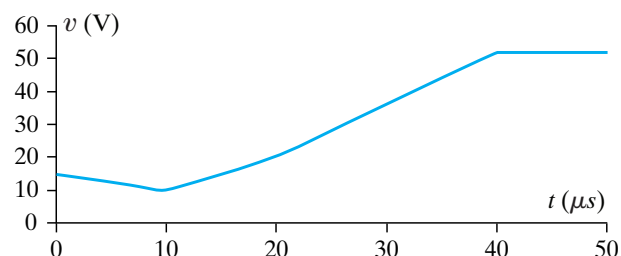
6.21 [a]  $-50 \times 10^4 t + 15 \text{ V}$

[b]  $10^6 t \text{ V}$

[c]  $1.6 \times 10^6 t - 12 \text{ V}$

[d]  $52 \text{ V}$

[e]


 6.27  $5 \text{ nF}$  with an initial voltage drop of  $+15 \text{ V}$ ;  
 $10 \mu\text{F}$  with an initial voltage drop of  $+25 \text{ V}$ 

6.31 [a]  $-20e^{-25t} \text{ V}, \quad t \geq 0$

[b]  $-16e^{-25t} + 21 \text{ V}, \quad t \geq 0$

[c]  $-4e^{-25t} - 21 \text{ V}, \quad t \geq 0$

[d]  $320 \mu\text{J}$

[e]  $2525 \mu\text{J}$

[f]  $2205 \mu\text{J}$

[g]  $2525 - 320 = 2205$

6.39 [a]  $0.2 \frac{di_2}{dt} + 10i_2 = -0.5 \frac{di_g}{dt}$

[b]  $0.2 \frac{di_2}{dt} + 10i_2 = 5e^{-10t}$  and  
 $-0.5 \frac{di_g}{dt} = 5e^{-10t}$

[c]  $-53.125e^{-10t} + 6.25e^{-50t} \text{ V}, \quad t > 0$

[d]  $-46.875 \text{ V}$

6.46 [a]  $50 \text{ mH}, 2.4$

[b]  $0.2 \times 10^{-6} \text{ Wb/A}, 0.2 \times 10^{-6} \text{ Wb/A}$

6.50 0.8 nWb/A, 1.2 nWb/A

6.53 [a] (2.1, 4.3); (3.2, 2.5); (2.1, 2.5);  
(3.2, 4.3)

[b] Zoom in

[c] Zoom out

**Chapter 7**

7.3 [a] 0.5 A

[b] 2 ms

[c]  $0.5e^{-500t}$  A,  $t \geq 0$ ;  $-80e^{-500t}$  V,  $t \geq 0^+$ ;  
 $-35e^{-500t}$  V,  $t \geq 0^+$ 

[d] 35.6%

7.9 [a] 0 A, 100 mA, 0 V

[b] 400 mA, 100 mA, -20 V

[c] 500 mA, 0 A, 0 V

[d]  $0.1e^{-4000t}$  A[e]  $0.5 - 0.1e^{-4000t}$  A[f]  $-20e^{-4000t}$  V7.19 [a]  $-10e^{-5000t}$  A  $t \geq 0$ 

[b] 80 mJ

[c]  $1.498\tau$ 7.23 [a]  $80e^{-375t}$  V  $t \geq 0$ [b]  $1.6e^{-375t}$  mA,  $t \geq 0^+$ 7.29 [a] 8 k $\Omega$ [b] 0.25  $\mu$ F

[c] 2 ms

[d] 648  $\mu$ J[e] 1139  $\mu$ s7.36 [a]  $-0.8 + 2.4e^{-4000t}$  A,  $t \geq 0$ ;  
 $41.6 + 19.2e^{-4000t}$  V,  $t \geq 0$ 

[b] -48 V, 60.8 V

7.47 17.33 ms

7.53 [a] 90 V

[b] -60 V

[c] 1000  $\mu$ s[d] 916.3  $\mu$ s

7.60 3.67 ms

7.68 [a]  $40 - 40e^{-5000t}$  mA,  $t \geq 0$ [b]  $10e^{-5000t}$  V,  $t \geq 0^+$ [c]  $16 - 16e^{-5000t}$  mA,  $t \geq 0$ [d]  $24 - 24e^{-5000t}$  mA,  $t \geq 0$ 

[e] Yes

7.72 -5.013 V

7.80 -5 V,  $0 \leq t \leq 5$  s;  
 $-5e^{-0.1(t-5)}$  V,  $5 \text{ s} \leq t < \infty$ 

7.88 83.09 ms

7.94 [a]  $\frac{1}{RC} \int_0^t (v_b - v_a) dy$ [b] Output is the integral of the difference  
between  $v_b$  and  $v_a$ , scaled by a factor of  
 $1/RC$ 

[c] 120 ms

7.105 73 beats per minute

**Chapter 8**

8.4 [a] -10,000 rad/s, -40,000 rad/s

[b] Overdamped

[c] 3125  $\Omega$ [d]  $-16,000 + j12,000$  rad/s,  
 $-16,000 - j12,000$  rad/s[e] 2500  $\Omega$ 8.7 [a] 1.25 H, 125  $\mu$ F, -200 V/s, 5 V[b]  $(2000t - 75)e^{-80t}$  mA,  $t \geq 0^+$ 8.11  $100e^{-400t} \cos 300t -$   
 $800e^{-400t} \sin 300t$  V,  $t \geq 0$ 8.13  $-300e^{-250t} + 400e^{-1000t}$  V,  $t \geq 0$ 8.28  $2 + \frac{1}{3}e^{-400t} - \frac{4}{3}e^{-1600t}$  A,  $t \geq 0$ 8.39 8 k $\Omega$ , 2 H, 7.5 mA, 08.50  $20 - 10,000te^{-500t} - 20e^{-500t}$  V,  $t \geq 0$

- 8.56 [a]  $25e^{-30,000t} \sin 40,000t$  V  
 [b]  $23.18 \mu\text{s}$   
 [c]  $9.98$  V  
 [d]  $100.73e^{-6000t} \sin 49,638.7t$  V,  $29.22 \mu\text{s}$ ,  
 $83.92$  V

- 8.63 [a]  $0 \leq t \leq 0.5^-$  s :  
 $v_{o1} = -1.6t$  V,  $v_o = 10t^2$  V  
 $0.5^+ \text{ s} \leq t \leq t_{\text{sat}}$  :  
 $v_{o1} = 0.8t - 1.2$  V,  $v_o = -5t^2 + 15t - 3.75$  V

[b]  $3.5$  s

- 8.67 [a]  $6.33$  pF  
 [b]  $5.03 \sin 4\pi \times 10^9 t$  V,  $t \geq 0$

## Chapter 9

- 9.3 [a]  $25$  V  
 [b]  $200$  Hz  
 [c]  $1256.64$  rad/s  
 [d]  $1.0472$  rad  
 [e]  $60^\circ$   
 [f]  $5$  ms  
 [g]  $416.67 \mu\text{s}$   
 [h]  $25 \cos 400\pi t$  V  
 [i]  $2.92$  ms

9.7  $\frac{V_m}{2}$

- 9.11 [a]  $28.38 \cos(200t + 170.56^\circ)$   
 [b]  $141.33 \cos(50t - 94.16^\circ)$   
 [c]  $16.7 \cos(5000t + 170.52^\circ)$   
 [d]  $0$

- 9.17 [a]  $160 + j120$  mS  
 [b]  $160$  mS  
 [c]  $120$  mS  
 [d]  $10$  A

9.29  $-120 \cos 8000t$  V

9.35  $500$  rad/s

9.42  $2/3 \Omega$

9.48  $6 + j4$  A in parallel with  $-20 + j20 \Omega$

9.54  $188.43 / -42.88^\circ$  V

9.58  $80 / 90^\circ$  V

9.64  $25 \sin 5000t$  V

9.77 [a]  $0.3536$

[b]  $2$  A

9.84 [a]  $247 + j7.25$  V

[b]  $-j32 \Omega$ ,  $241 + j8$  V

[c]  $-26.90 \Omega$

9.88 [a]  $0$  A

[b]  $0.436 / 0^\circ$  A

[c] Yes

## Chapter 10

- 10.1 [a]  $129.41$  W(abs),  $482.96$  VAR(abs)  
 [b]  $-11.65$  W(del),  $43.47$  VAR(abs)  
 [c]  $-63.39$  W(del),  $-135.95$  VAR(del)  
 [d]  $257.12$  W(abs),  $-306.42$  VAR(del)

10.2 [a] No

[b] Yes

10.7  $5$  mW

10.15 [a]  $15.81$  V(rms)

[b]  $62.5$  W

10.20 [a]  $-6.4$  W,  $-4.8$  VAR,  $8$  VA

[b]  $\sum P_{\text{abs}} = 6.4$  W =  $\sum P_{\text{dev}}$

[c]  $\sum Q_{\text{abs}} = 4.8$  VAR =  $\sum Q_{\text{dev}}$

10.30 [a]  $0.96$  (lag),  $0.28$ ;  $0.8$  (lead),  $-0.6$ ;  
 $0.6$  (lead),  $-0.8$

[b]  $0.74$  (lead),  $-0.67$

10.41 [a]  $2000 - j2000 \Omega$

- [b] 3.125 mW  
 [c]  $R = 1.8 \text{ k}\Omega$  and  $C = 47 \text{ nF}$  gives 3.03 mW
- 10.48 [a] 360 mW  
 [b]  $4000 \Omega$ ,  $0.1 \mu\text{F}$   
 [c] 443.1 mW  
 [d] 450 mW  
 [e]  $4000 \Omega$ ,  $66.67 \text{ nF}$   
 [f] Yes
- 10.56 [a]  $-21/\underline{0^\circ}$  V(rms)  
 [b] 63 W  
 [c] 9.72%
- 10.62 [a] 125  
 [b] 26.28125 W
- 10.67 [a] 15.63 kWh  
 [b] 11.72 kWh  
 [c] 9.16 kWh  
 [d] 6.64 kWh

## Chapter 11

- 11.1 [a] abc  
 [b] acb
- 11.11 [a] 15.24 A(rms)  
 [b] 6583.94 V(rms)
- 11.12 [a]  $5/\underline{-36.87^\circ}$  A(rms),  $5/\underline{83.13^\circ}$  A(rms),  
 $5/\underline{-156.87^\circ}$  A(rms)  
 [b]  $216.51/\underline{-30^\circ}$  V(rms),  $216.51/\underline{90^\circ}$  V(rms),  
 $216.51/\underline{-150^\circ}$  V(rms)  
 [c]  $122.23/\underline{-1.36^\circ}$  V(rms),  $122.23/\underline{118.64^\circ}$   
 V(rms),  $122.23/\underline{-121.36^\circ}$  V(rms)  
 [d]  $211.72/\underline{-31.36^\circ}$  V(rms),  $211.72/\underline{88.64^\circ}$   
 V(rms),  $211.72/\underline{-151.36^\circ}$  V(rms)
- 11.15  $21.64/\underline{121.34^\circ}$  A(rms)
- 11.16  $159.5/\underline{29.34^\circ}$  V(rms)
- 11.25  $6120/\underline{36.61^\circ}$  VA
- 11.27 [a]  $1833.46/\underline{22^\circ}$  VA  
 [b] 519.62 V(rms)
- 11.35 6990.62 V(rms)
- 11.45 [a] proof  
 [b] 2592 VAR,  $-2592$  VAR, 3741.23 VAR,  
 $-4172.80$  VAR
- 11.54 [a]  $16.71 \mu\text{F}$   
 [b]  $50.14 \mu\text{F}$

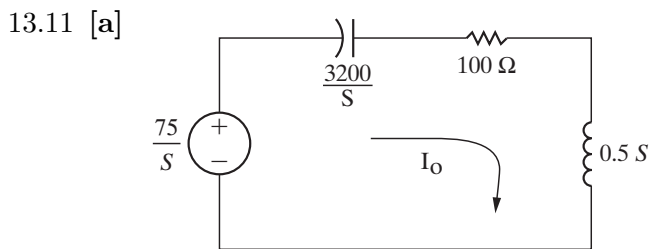
## Chapter 12

- 12.3 [a]  $-3(t+5)u(t+5) + 30u(t) + 3(t-5)u(t-5)$   
 [b]  $5(t+4)u(t+4) - 10(t+2)u(t+2) +$   
 $10(t-2)u(t-2) - 5(t-4)u(t-4)$
- 12.10  $\frac{2}{9}$
- 12.20 [a]  $\frac{1}{(s+a)^2}$   
 [b]  $\frac{\omega}{s^2 + \omega^2}$   
 [c]  $\frac{\omega \cos \theta + s \sin \theta}{s^2 + \omega^2}$   
 [d]  $\frac{1}{s^2}$   
 [e]  $\frac{\sinh \theta + s[\cosh \theta]}{(s^2 - 1)}$
- 12.22 [a]  $\frac{s\omega}{s^2 + \omega^2}$   
 [b]  $\frac{-\omega^2}{s^2 + \omega^2}$   
 [c] 2  
 [d] Check
- 12.26  $\frac{100s^2}{(s^2 + 16s + 100)(s^2 + 400)}$
- 12.40 [a]  $[10e^{-5t} - 4e^{-8t}]u(t)$   
 [b]  $[15 - 6e^{-3t} + 11e^{-7t}]u(t)$
- 12.41 [a]  $[20e^{-7t} \sin 14t]u(t)$   
 [b]  $[5 + 7.2e^{-5t} \cos(8t - 146.31^\circ)]u(t)$

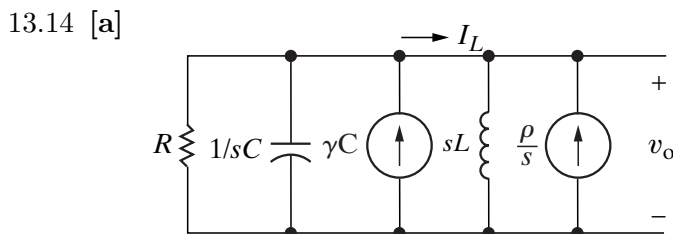
- [c]  $[10e^{-6t} + 5.66e^{-2t} \cos(4t + 45^\circ)]u(t)$   
 [d]  $[9.25e^{-5t} \cos(3t - 40.05^\circ) + 7.21e^{-4t} \cos(2t + 168.93^\circ)]u(t)$
- 12.43 [b]  $[10te^{-t} \cos(t - 90^\circ) + 10e^{-t} \cos(t - 90^\circ)]u(t)$   
 [c]  $25\delta(t) + [8e^{-6t} + 12e^{-9t}]u(t)$
- 12.50 [a] 6, 0  
 [b] 20, 15  
 [c] 15, 0  
 [d] 2, 9
- 12.55 0.947

### Chapter 13

- 13.4 [a]  $\frac{[s^2 + 32,000s + 4 \times 10^8]}{s}$   
 [b] Zeros at  $-16,000 + j12,000$  rad/s,  
 $-16,000 - j12,000$  rad/s;  
 Pole at 0
- 13.5 [a]  $\frac{16 \times 10^9 s}{s^2 + 2 \times 10^6 s + 64 \times 10^{10}}$   
 [b] Zero at  $z_1 = 0$ ;  
 Poles at  $-400$  krad/s,  $-1600$  krad/s



- [b]  $\frac{150}{(s + 40)(s + 160)}$   
 [c]  $(1.25e^{-40t} - 1.25e^{-160t})u(t)$  A



where  $R = 1$  k $\Omega$ ,  $C = 6.25$  nF  
 $\gamma = -240$  V,  $L = 16$  mH,  $\rho = -0.24$  A

- [b]  $\frac{-240(s + 160,000)}{s^2 + 160,000s + 10^{10}}$   
 [c]  $\frac{0.24(s + 97,500)}{(s^2 + 160,000s + 10^{10})}$   
 [d]  $[400e^{-80,000t} \cos(60,000t + 126.87^\circ)]u(t)$  V  
 [e]  $[0.5e^{-80,000t} \cos(60,000t - 16.26^\circ)]u(t)$  A
- 13.19 [a]  $[1 - 1e^{-250t} \cos 250t]u(t)$  A  
 [b]  $141.42e^{-250t} \cos(250t - 45^\circ)u(t)$  V  
 [c] Yes
- 13.25 [a]  $[35 + 5.73e^{-t} \cos(7t + 167.91^\circ)]u(t)$  V  
 [b] Yes
- 13.35  $63.25e^{-150t} \cos(50t + 71.57^\circ)u(t)$  mA
- 13.37 [a]  $(-0.5e^{-40t} + 0.5e^{-1600t})u(t)$  A  
 [b]  $(0.5e^{-400t} - 0.5e^{-1600t})u(t)$  A
- 13.43 [a]  $\frac{32 \times 10^4(s + 320)}{s(s + 400)(s + 600)}$   
 [b]  $[426.67 + 320e^{-400t} - 746.67e^{-600t}]u(t)$  V
- 13.52 [a]  $\frac{25}{s + 25}$ ; no zeros, pole at  $-25$  rad/s  
 [b]  $\frac{s}{s + 25}$ ; zero at 0, pole at  $-25$  rad/s  
 [c]  $\frac{s}{s + 2000}$ ; zero at 0, pole at  $-2000$  rad/s  
 [d]  $\frac{2000}{s + 2000}$ ; no zeros, pole at  $-2000$  rad/s  
 [e]  $\frac{0.2s}{s + 3200}$ ; zero at 0, pole at  $-3200$  rad/s
- 13.60  $(1 - e)e^{-t}$  V
- 13.77 [a]  $\frac{s(s + 30,000)}{(s + 5000)(s + 8000)}$   
 [b]  $(5e^{-5000t} - 4.4e^{-8000t})u(t)$  V  
 [c]  $4.42 \cos(10,000t - 6.34^\circ)$  V
- 13.78  $4.4 \cos(20t - 33.57^\circ)$  V
- 13.88 [a] 0.8 A  
 [b] 0.6 A  
 [c] 0.2 A  
 [d]  $-0.6$  A  
 [e]  $0.6e^{-2 \times 10^6 t}u(t)$  A

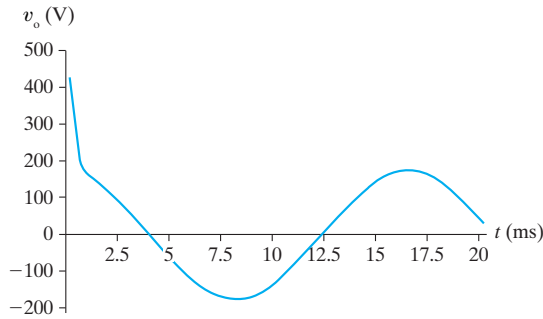
[f]  $-0.6e^{-2 \times 10^6 t} u(t)$  A  
 [g]  $[-1.6 \times 10^{-3} \delta(t)] - [7200e^{-2 \times 10^6 t} u(t)]$  V

13.92 [a] 0 A,  $25\sqrt{2}$  A

[b]  $\frac{1440\pi(122.92\sqrt{2}s - 3000\pi\sqrt{2})}{(s + 1475\pi)(s^2 + 14,400\pi^2)} + \frac{300\sqrt{2}}{s + 1475\pi}$ ,  $178.82\sqrt{2}e^{-1475\pi t} + 122.06\sqrt{2} \cos(120\pi t + 6.85^\circ)$  V,  $300\sqrt{2}$  V

[c]  $122.06\sqrt{2} \cos(120\pi t + 6.85^\circ)$  V

[d]



### Chapter 14

14.1 [a] 3819.72 Hz  
 [b]  $0.7071 \angle -45^\circ$ ,  $0.9923 \angle -7.125^\circ$ ,  $0.124 \angle -82.875^\circ$   
 [c]  $14.142 \cos(24,000t - 45^\circ)$  V,  
 $19.846 \cos(3000t - 7.125^\circ)$  V,  
 $2.48 \cos(192,000t - 82.875^\circ)$  V

14.7 [a]  $31.42 \Omega$   
 [b] 3419.98 Hz  
 [c] With  $33 \Omega$  resistor, 5252.11 Hz

14.13 [a]  $5.305 \text{ k}\Omega$   
 [b] 333.86 Hz

14.17 [a]  $150 \Omega$   
 [b]  $680 \Omega$

14.25 [a]  $5 \text{ k}\Omega$ , 50 mH  
 [b] 3.52 kHz, 2.88 kHz  
 [c] 636.62 Hz

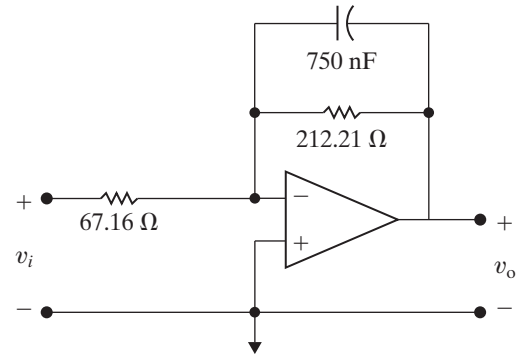
14.34  $4 \text{ k}\Omega$

14.42 [a]  $397.89 \Omega$ , 3.17 mH  
 [b] 4.42 kHz, 3.62 kHz  
 [c] 800 Hz

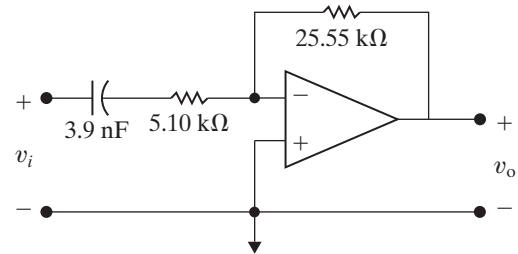
14.51 [a] 0.39 H,  $0.1 \mu\text{F}$   
 [b]  $|V_{697\text{Hz}}| = |V_{941\text{Hz}}| = 0.707|V_{\text{peak}}|$ ;  
 $|V_{770\text{Hz}}| = |V_{852\text{Hz}}| = 0.948|V_{\text{peak}}|$   
 [c]  $0.344|V_{\text{peak}}|$

### Chapter 15

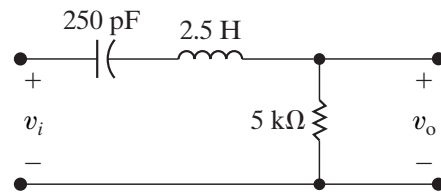
15.1 [a]  $67.16 \Omega$ ,  $212.21 \Omega$   
 [b]



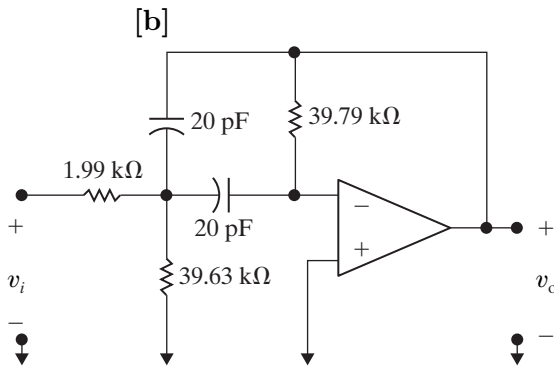
15.8 [a] 5.1 k $\Omega$ , 25.55 k $\Omega$   
 [b]



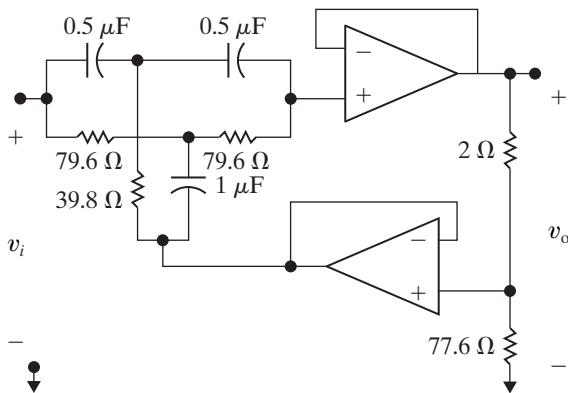
15.15 [a] 1 H,  $0.05 \Omega$ , 1 F  
 [b] 2.5 H, 5 k $\Omega$ , 250 pF  
 [c]



- 15.23 [a] 20 mH, 2.5  $\mu$ F  
 [b] 13.42  $\cos(10,000t - 166.57^\circ)$  mA
- 15.30 38.52 Hz, 1038.52 Hz, 30.65  $\Omega$ , 826.43  $\Omega$
- 15.31  $R_L = 21.18$  k $\Omega$ ,  $R_H = 1.18$  k $\Omega$ , if  $R_i = 1$  k $\Omega$   
 then  $R_f = 6$  k $\Omega$
- 15.34 [a] 3  
 [b] -32.65 dB
- 15.49 [a]  $R_1 = 1.99$  k $\Omega$ ,  $R_2 = 39.63$  k $\Omega$ ,  
 $R_3 = 39.79$  k $\Omega$



- 15.60 [a] See component values in part (b)  
 [b]



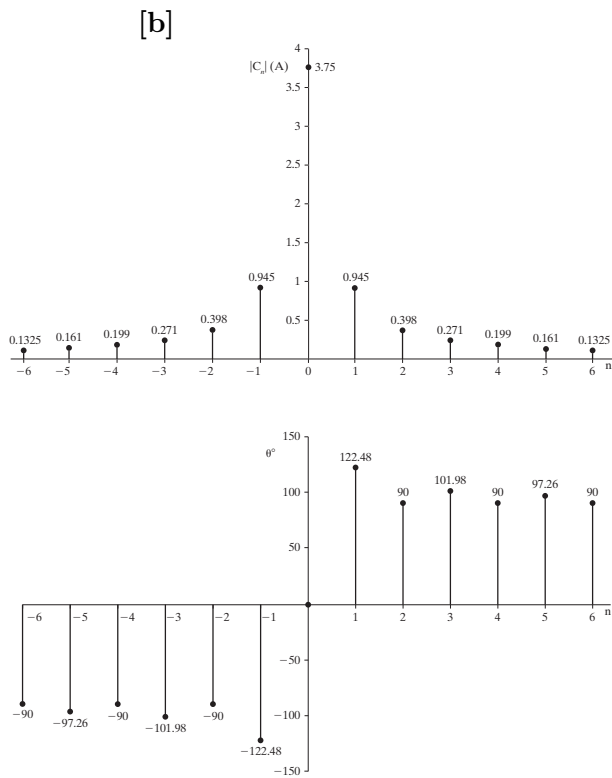
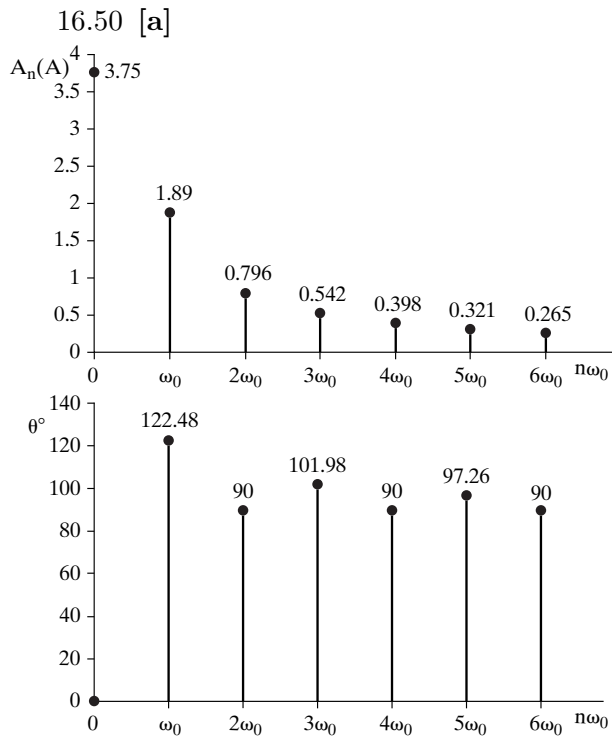
[c]  $\frac{s^2 + 64 \times 10^6 \pi^2}{s^2 + 800\pi s + 64 \times 10^6 \pi^2}$

- 15.62  $R_1 = 100$  k $\Omega$ ,  $R_2 = 900$  k $\Omega$ ,  $C_1 = 2.36$  nF

## Chapter 16

- 16.1 [a] 785.4 rad/s, 78.54 krad/s  
 [b] 125 Hz, 12.5 Hz  
 [c] 25 V, 0  
 [d]  $a_{ka} = \frac{100}{\pi k} \sin \frac{\pi k}{2}$ ,  $b_{ka} = 0$ ;  
 $a_{kb} = \frac{120}{\pi k} \sin \frac{\pi k}{2}$  for  $k$  odd,  $a_{kb} = 0$   
 for  $k$  even,  $b_{kb} = \frac{120}{\pi k} [1 - \cos(k\pi)]$   
 for  $k$  odd,  $b_{kb} = 0$  for  $k$  even  
 [e]  $25 + \frac{100}{\pi} \sum_{n=1}^{\infty} \left( \frac{1}{n} \sin \frac{n\pi}{2} \cos n\omega_o t \right)$  V,  
 $\frac{120}{\pi} \sum_{n=1,3,5}^{\infty} \frac{1}{n} \left( \sin \frac{n\pi}{2} \cos n\omega_o t + 2 \sin n\omega_o t \right)$  V
- 16.3  $\frac{75}{\pi} + 12.5 \cos \omega_o t -$   
 $\frac{150}{\pi} \sum_{n=2,4,6}^{\infty} \frac{\cos(n\pi/2) \cos(n\omega_o t)}{(1 - n^2)}$  V
- 16.11 [a]  $\pi$  rad/s  
 [b] yes  
 [c] no  
 [d] yes
- 16.22 [a]  $10 \sum_{n=1,3,5,\dots}^{\infty} \frac{\sqrt{(n\pi)^2 + 4}}{n^2} \cos(n\omega_o t - \theta_n)$  A,  
 $\theta_n = \tan^{-1} \frac{n\pi}{2}$   
 [b] 26.23 A
- 16.28 [a]  $1.9999 \cos(200t - 0.48^\circ) + 0.6662 \cos(600t + 177.85^\circ) + 0.286 \cos(1400t - 176.66^\circ)$  V  
 [b] Fifth harmonic
- 16.35 1.85 W
- 16.39 [a] 117.55 V(rms)  
 [b] -2.04%  
 [c] 69.2765 V(rms), -0.0081%
- 16.44  $C_0 = \frac{V_m}{2}$ ,  $C_n = j \frac{V_m}{2n\pi}$ ,  $n = \pm 1, \pm 2, \dots$

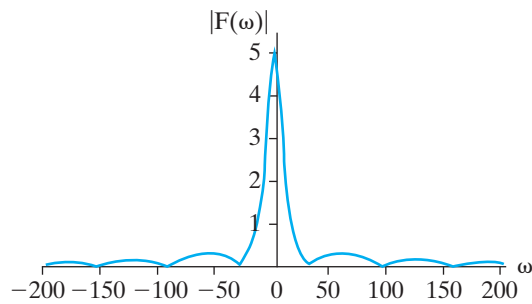




- 16.57 [a]  $\frac{400}{313}$ ; 2000 rad/s,  $16 \times 10^8$  rad<sup>2</sup>/sec<sup>2</sup>  
 [b]  $-80 \cos \omega_0 t - 0.50 \cos(3\omega_0 t + 91.07^\circ) + 0.17 \cos(5\omega_0 t + 90.60^\circ)$  V

### Chapter 17

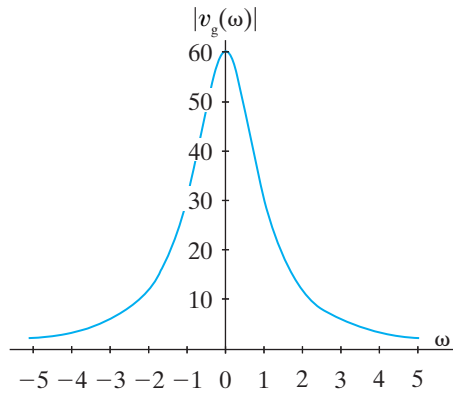
- 17.1 [a]  $j \frac{2A}{\tau} \left[ \frac{\omega\tau \cos(\omega\tau/2) - 2 \sin(\omega\tau/2)}{\omega^2} \right]$   
 [b] 0  
 [c]



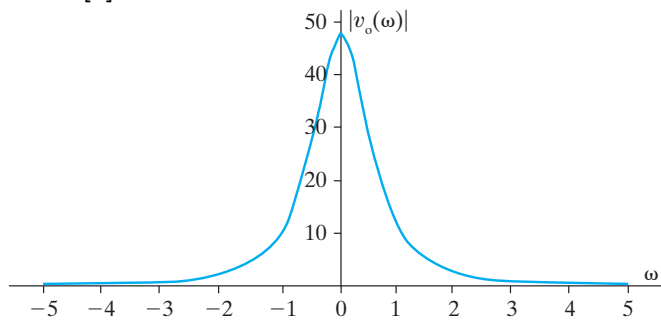
- 17.5 [a]  $\frac{2(a^2 - \omega^2)}{(a^2 + \omega^2)^2}$   
 [b]  $-j48a\omega \frac{(a^2 - \omega^2)}{(a^2 + \omega^2)^4}$   
 [c]  $\frac{a}{a^2 + (\omega - \omega_0)^2} + \frac{a}{a^2 + (\omega + \omega_0)^2}$   
 [d]  $\frac{-ja}{a^2 + (\omega - \omega_0)^2} + \frac{ja}{a^2 + (\omega + \omega_0)^2}$   
 [e]  $e^{-j\omega t_0}$
- 17.19 [a]  $\frac{\tau}{2} \cdot \frac{\sin[(\omega + \omega_0)\tau/2]}{(\omega + \omega_0)(\tau/2)} + \frac{\tau}{2} \cdot \frac{\sin[(\omega - \omega_0)\tau/2]}{(\omega - \omega_0)(\tau/2)}$   
 [b]  $F(\omega) \rightarrow \pi[\delta(\omega - \omega_0) + \delta(\omega + \omega_0)]$
- 17.28 [a]  $[416.67e^{-20t} - 250e^{-100t}]u(t) + 166.67e^{100t}u(-t)$  V  
 [b] 166.67 V  
 [c] 166.67 V  
 [d]  $(416.67e^{-20t} - 250e^{-100t})u(t)$  V  
 [e] Yes
- 17.30  $1 \cos(5000t + 90^\circ)$  A

17.40 [a]  $[-24e^{-t} + 32e^{-t/2}]u(t) + 8e^t u(-t)$  V

[b]



[c]



[d] 900 J

[e] 320 J

[f] 95.95%

[g] 99.75%

## Chapter 18

18.2  $z_{11} = 13 \Omega$ ;  $z_{12} = 12 \Omega$ ;  
 $z_{21} = 12 \Omega$ ;  $z_{22} = 16 \Omega$

18.10  $a_{11} = -4 \times 10^{-4}$ ;  $a_{12} = -20 \Omega$ ;  
 $a_{21} = -0.5 \mu\text{S}$ ;  $a_{22} = -0.02$

18.13  $g_{11} = 12.5 \mu\text{S}$ ;  $g_{12} = 1.5$ ;  
 $g_{21} = -250$ ;  $g_{22} = 50 \text{ M}\Omega$

18.14 [a]  $y_{11} = 20 \mu\text{S}$ ;  $y_{12} = 30 \text{ nS}$ ;  
 $y_{21} = 5 \mu\text{S}$ ;  $y_{22} = 20 \text{ nS}$

[b]  $y_{11} = 20 \mu\text{S}$ ;  $y_{12} = 30 \text{ nS}$ ;  
 $y_{21} = 5 \mu\text{S}$ ;  $y_{22} = 20 \text{ nS}$

18.21  $a_{11} = 3$ ;  $a_{12} = 40 \Omega$ ;  $a_{21} = 80 + j60 \text{ mS}$ ;  
 $a_{22} = 2.4 + j0.8$

18.31 [a] 28 V(rms)

[b] 11.20 mW

[c]  $2.88 \mu\text{W}$

18.33 12.5

18.38 3.75 V

*This page intentionally left blank*



# Index

## A

a-, b-, and c-phase voltage, 398–399, 403, 417  
Active circuit element, 27  
Active filter circuits, 556–601  
    bandpass filters, 564–568, 583–586, 592–593  
    bandreject filters, 568–571, 583, 586–589, 592–593  
    bass volume control, 557, 589–591  
    block diagrams, 565–566  
    Bode plots, 558–561  
    broadband filters, 565–571, 592  
    Butterworth filters, 576–584, 592–593  
    cascading, 564–574, 592  
    first-order, 558–571  
    frequency response plots, 558–561  
    higher-order, 571–584, 592–593  
    high-pass filters, 560–561, 583, 592  
    low-pass filters, 522–530, 548, 558–560, 572–574, 576–580, 592–593  
    narrowband filters, 584–589, 593  
    op amp filters, 556–601  
    prototype filters, 559–564, 592  
    scaling, 562–564, 592  
Adjoint of a matrix, 713–714  
Admittance ( $Y$ ), 322, 345  
Ammeter, 66–67, 76  
Amplifier circuits, 98–99, 105–106, 118–119, 144–173, 241–244, 246, 289–293, 295, 677, 695  
    analysis of, 98–99, 105–106, 118–119, 241–244, 289–293  
    black box, 677, 695  
    integrating, 241–244, 246, 289–293, 295  
    mesh-current method for, 105–106  
    node-voltage method for, 98–99  
    operational (op amp), 144–173  
    responses and, 241–244, 246, 289–293, 295  
    Thévenin equivalent in, 118–119  
Amplitude modulation, 657  
Amplitude plots, 740–745, 749–752  
Amplitude spectrum, 628–630, 645–646  
Analog meters, 67, 76  
Aperiodic functions, 644–646  
Apparent power, 368, 384  
Appliance ratings, 365  
Arcing, 176  
Asterisk (\*) notation, 489  
Attenuation, 520  
Average power ( $P$ ), 361–365, 371–373, 378, 384, 408–409, 413–415, 417, 621–624, 633  
    appliance ratings, 365  
    capacitive circuits, 363

    equations for, 371–373  
    Fourier series analysis for, 621–624, 633  
    inductive circuits, 362–363  
    instantaneous, 362  
    maximum power ( $P_{\max}$ ) transfer, 378  
    measurement of, 413–415, 417  
    periodic functions, calculations with, 621–624, 633  
    power factor (pf), 363, 384  
    resistive circuits, 362  
    root-mean-square (rms) value, 366–367  
    sinusoidal steady-state calculations of, 361–365, 371–373, 384  
balanced three-phase circuits, 408–409, 413–415, 417  
two-wattmeter method, 413–415, 417  
wye (Y) connected loads, 408–409

## B

Balanced three-phase circuits, 396–425  
    average power in, 413–415, 417  
    circuit symbols for, 399–400, 405  
    complex power in, 409  
    conditions for, 401  
    delta ( $\Delta$ ) connected loads, 409–410  
    electrical power, transmission and distribution of, 396–397, 416–417  
    instantaneous power in, 410  
    Kirchhoff's laws for, 402–403, 406  
    line current, 403, 406–407  
    line voltage, 402–404  
    neutral terminal for, 399  
    phase current, 403, 405–407  
    phase voltage, 398, 402–404  
    power calculations in, 408–413, 417  
    single-phase equivalent circuits, 402–403, 417  
    sinusoidal voltage phases for, 398–399, 417  
    sources of three-phase voltage, 399–400  
    two-wattmeter method for power measurement, 413–415, 417  
    unspecified loads, 412  
    voltages ( $v$ ), 398–405, 417  
    wye (Y) connected loads, 408–409  
    wye-delta (Y- $\Delta$ ) circuit analysis, 405–407  
    wye-wye (Y-Y) circuit analysis, 400–405, 417  
Bandpass filters, 523, 534–543, 549, 564–568, 583–586, 592–593  
    active filter circuits, 564–568, 583–586, 592–593  
    bandwidth ( $\beta$ ), 535, 537, 549  
    Bode plot, components from, 564–565  
    broadband, 565–571, 592

## Bandpass filters (Continued)

- Butterworth, 583, 593
  - cascading, 564–568
  - center (resonant) frequency ( $\omega_o$ ), 534–537, 549
  - cutoff frequency ( $\omega_c$ ), 537, 549
  - frequency response plots, 523, 535
  - high-Q filters, 584–586, 603, 630–632
  - narrowband, 584–586
  - operational amplifier (op amp), 564–568, 583–586, 592–593
  - passive filter circuits, 523, 534–543, 549
  - qualitative analysis, 535–536
  - quality factor ( $Q$ ), 535, 538, 549, 584–585
  - quantitative analysis, 536–538
  - relationship between frequency and time domains, 543
  - $RLC$  circuits as, 535–543
  - transfer function  $H(s)$  for, 542, 549, 569, 584
- Bandreject filters, 523, 543–547, 549, 568–571, 583, 586–589, 592–593
- active filter circuits, 568–571, 583, 586–589, 592–593
  - bandwidth ( $\beta$ ), 545–546
  - Bode plot, components from, 568–569
  - Butterworth filters, 583, 593
  - center (resonant) frequency ( $\omega_c$ ), 545–546
  - cutoff frequency ( $\omega_c$ ), 545–546
  - frequency response plots, 523, 544
  - high-Q filters, 586–589
  - narrowband filters, 586–589
  - operational amplifier (op amp) filters, 568–571, 583
  - passive filter circuits, 523, 543–547, 549
  - qualitative analysis, 544
  - quantitative analysis, 544–547
  - quality factor ( $Q$ ), 545
  - series  $RLC$  circuit as, 543–547
  - transfer function  $H(s)$  for, 544–545, 547, 549, 569
  - twin-T notch filter, 586–589
- Bandwidth ( $\beta$ ), 535, 537, 545–546, 549
- Bass volume control, 557, 589–591
- Black box amplifier, 677, 695
- Black box concept, 58
- Bode plots, 558–561, 564–565, 572, 739–755
- active filter analysis using, 558–561, 564–565
  - amplitude, 740–745, 749–752
  - cascading identical filters, 572
  - complex poles and zeros, 747–749
  - correcting, 750–752
  - frequency response, 558–561
  - op-amp filter components from, 564–565
  - phase angle, 745–747, 753–755
  - real, first order poles and zeros, 739–740
  - straight-line amplitude, 740–744, 750–752
  - straight-line phase angle, 745–747
- Branch, defined, 90–91
- Broadband filters, 565–571, 592
- Butterworth filters, 576–574, 592–593
- bandpass, 583, 593
  - bandreject, 583, 593

- design of circuits, 577–579
- high-pass, 583, 592–593
- low-pass, 576–582, 594–595
- order of cascading, 580–582
- transfer function  $H(s)$ , 576–579, 583, 592

## C

- Capacitance ( $C$ ), 174, 182, 187–189, 200–203
- circuit parameter of, 174, 182, 202
  - displacement current, 182
  - equivalent initial voltage, 188
  - series-parallel combinations, 187–189, 203
  - terminal equations for, 182–186, 203
  - touch screens, 200–202
- Capacitive circuits, power calculations for, 363
- Capacitors, 174, 182–189, 202–203, 286–287, 317–318, 467–468, 496–497, 504, 761
- behavior of, 174
  - circuit symbol for, 182
  - component values, 761
  - current ( $i$ ), 182–185, 202–203
  - current to voltage ( $i$ - $v$ ) relationships, 182–183, 318
  - displacement current, 182
  - energy ( $w$ ) in, 184–186, 202
  - frequency domain, 317–318
  - impulse function ( $I$ ) in, 496–497
  - Laplace transform used for, 467–468, 496–497, 504
  - power ( $p$ ) in, 183–186, 202
  - $s$ -domain, 467–468, 504
  - series-parallel combinations, 187–189, 203
  - series  $RLC$  voltage step response, 286–287
  - switching operation, 496–497
  - terminal equations for, 182–186, 203, 467–468
  - touch screens, 175, 200–202
  - voltage ( $v$ ), 183–186, 202–203
  - voltage to current ( $v$ - $i$ ) relationships, 183, 317–318
- Cascade connections, 289–293, 295, 564–568, 572–575, 578–584, 592–593, 692–694
- active filters, 564–568, 572–575, 578–584, 592–593
  - bandpass filters, 564–568
  - Butterworth filters, 578–584, 592–593
  - first-order filters, 564–568
  - higher-order filters, 572–575
  - identical filters, 572–575
  - integrating amplifiers, 289–293, 295
  - low-pass filters, 572–575, 592
  - order of filters, 573–574, 580–582, 592–593
  - transfer function  $H(s)$  and, 572–575
  - two-port circuits, 692–694
- Center frequency ( $\omega_o$ ), 534–537, 545–546, 549
- Characteristic determinant, 704
- Characteristic equation, 267, 269–270, 286, 295
- defined, 267
  - parallel  $RLC$  circuits, 267, 267–270, 295
  - roots of, 267, 269–270, 286, 295
  - series  $RLC$  circuits, 286, 295

- Circuit analysis, 10–11, 30–33, 37–45, 48, 64–66, 71–73, 75–76, 88–143, 159–162, 319–332, 342–345, 464–519, 687–691
- amplifiers, 98–99, 105–106, 118–119
- conceptual model, 10–11
- current-division, 64–66, 75–76
- delta to wye ( $\Delta$  to  $Y$ ) transformations, 71–73, 76, 324–326
- dependant-source circuits, 42–45, 95–96, 102–103, 116, 118
- frequency domain, 319–332, 345
- ideal circuit components, 11
- impedance ( $Z$ ) in series and parallel, 320–324
- impulse function  $K\delta(t)$  in, 496–502, 504
- independent-source circuits, 117–118
- inverting-amplifier, 160
- Kirchhoff's laws, 37–41, 48, 319–320, 469
- Laplace transform in, 464–519
- maximum power transfer, 120–122, 129
- mesh-current method, 90, 99–109, 129, 331–332
- node-voltage method, 90, 93–99, 106–109, 129, 330–331
- noninverting-amplifier, 160–161
- nonplanar circuits, 90–91
- Norton equivalent, 113, 115, 129, 327
- Ohm's law, 30–33, 48, 468–469
- operational amplifier (op amp) models, 159–162
- phasor diagrams for, 342–344
- physical prototype, 11
- planar circuits, 90–91
- resistive circuits, 71–73, 76
- $s$ -domain, 468–502, 504
- sensitivity, resistors, 89, 125–128
- simultaneous equations for, 91–93
- sinusoidal steady-state, 319–332, 342–345
- source transformations, 109–113, 115–116, 129, 327–328
- superposition for, 122–125, 129, 480–482
- terminology for, 90–91
- Thévenin equivalent, 113–119, 129, 327–329, 477–478
- transfer function  $H(s)$  in, 482–495, 504
- two-port circuits, 687–691
- voltage-division, 64–66, 75
- Circuit theory, 6–7
- Circuit transformations, 71–73, 76, 109–113, 115–116, 129, 327–329
  - equivalent circuits, 71–73, 76
  - Norton equivalent circuits, 115, 327
  - source, 109–113, 115–116, 129
  - Thévenin equivalent circuit, 115–116, 327–329
- Circuits, 2–87, 212–303, 305, 344, 396–475, 427, 440–442, 456–457, 466–468, 486–487, 504, 520–601, 676–701.
  - See also* Amplifier circuits; Circuit analysis; Equivalent circuits; Ideal basic circuit elements
  - active filter, 556–601
  - balanced three-phase, 398–427
  - clock for computer timing, 265, 293–294
  - constant (dc) sources, 56
  - current ( $i$ ), 11–13, 26–33, 37–42
  - dependent sources, 26–27, 29, 42–45, 48
  - electric radiators, 25, 46–74
  - electrical engineering and, 2–8
  - electrical resistance, 30–33
  - energy and, 14–17
  - first-order, 212–263
  - frequency-selective, 520–601
  - household distribution, 305, 344
  - ideal basic elements, 12–14, 24–55
  - International System of Units (SI) for, 8–10
  - Kirchhoff's laws, 37–41, 48
  - Laplace transforms and, 466–468, 486–487, 504
  - lumped-parameter, 440–442, 457
  - models of, 10–11, 17–18, 34–36
  - Ohm's law, 30–31, 48
  - open, 35
  - parallel-connected (in parallel), 59–61, 75
  - passive filter, 520–555
  - passive sign convention, 13
  - power ( $p$ ) and, 14–17
  - resistive, 56–87
  - responses of, 212–303
  - $s$  domain, 466–468, 504
  - second-order, 264–303
  - series-connected (in series), 39, 48, 58, 75
  - short, 35
  - time-invariant, 486–487, 504
  - transient effects on, 427, 456–457
  - two-port, 676–701
  - variables of, 2–23
  - voltage ( $v$ ), 11–13, 26–29, 32–33
- Clock for computer timing, 265, 293–294
- Closed loop (path), 38, 48
- Coefficient of coupling, 197, 203
- Cofactor, 705–706
- Column matrix, 708
- Common mode input, 156–157, 164
- Common mode rejection ratio (CMRR), 157–159, 164
- Communication systems, 4
- Complex numbers, 723–728
  - arithmetic operators, 725–726
  - graphical representation of, 724–725
  - integer power of, 727
  - notation, 723–724
  - roots of, 727–728
  - useful identities of, 726–727
- Complex poles and zeros, 747–749
- Complex power ( $S$ ), 368–372, 384, 409
  - apparent power (magnitude of), 368, 384
  - equations for, 369–372
  - impedance ( $Z$ ) and, 371–372
  - sinusoidal steady-state calculations of, 368–372, 384
  - three-phase circuits, 409
- Computer systems, 4
- Conductance ( $G$ ), 31, 60, 322
- Conjugate of complex numbers, 724–725
- Constant (dc) sources, 56

Control systems, 4–5  
 Controlled sources, 27  
 Convolution, 487–493, 504, 657–658  
   Fourier operational transforms for, 657–658  
   integral for transfer function and, 487–493, 504  
 Corner frequency, 741  
 Cosine functions, 615–616, 652–653  
 Cramer’s method, 704  
 Critically damped responses, 269, 277–278, 283, 286, 295–296  
   natural response equations, 277–278, 295  
   parallel RLC circuits, 269, 277–278, 283, 295  
   series RLC circuits, 286, 295  
   step response equations, 286, 296  
 Current ( $i$ ), 11–13, 18, 26–33, 37–42, 48, 66–69, 76, 100, 146–150, 164, 177–179, 182–185, 187–188, 202–203, 214–216, 286, 306–307, 319–320, 338–340, 403, 405–407, 417  
   ammeters, 66–67, 76  
   capacitors, 182–185, 202–203  
   defined, 12, 18  
   determination of, 177–179  
   displacement, 182  
   electric charge and, 11–13  
   equivalent inductance in, 188  
   frequency domain, 319–320, 338–340, 345  
   inductors, 177–179, 187–188, 202–203, 215  
   input constraints, 148–149, 164  
   Kirchhoff’s law (KCL), 37–41, 48, 319–320, 406  
   line, 403, 406–407  
   measurement of, 66–69, 76  
   mesh, 100  
   natural response and, 214–216, 286  
   Ohm’s law, 30–31, 48  
   operational amplifiers (op amps), 146–150, 164  
   phase, 403, 405–407  
   polarity of, 339–340  
   power in a resistor, 32–33, 48  
   RC circuit expression for, 214–216  
   reference direction, 13  
   RLC circuit expression for, 286  
   sinusoidal source, 306–307, 345  
   sources, 26–29, 48  
   terminal variable characteristics, 146–150, 164  
   three-phase, 403, 405–407, 417  
   transformer ratio, 338–340, 345  
   voltage ( $v$ ) and, 11–13, 177–179  
   wye-delta (Y- $\Delta$ ) circuit analysis and, 405–407  
 Current coil, 413  
 Current-divider circuits, 63, 75  
 Current-division circuit analysis, 64–66, 75–76  
 Current to voltage ( $i$ - $v$ ) relationships, 177–178, 182–183, 318  
 Cutoff frequency ( $\omega_c$ ), 522–523, 525–526, 531, 533, 537, 545–546, 548  
   bandpass filters, 537

bandreject filters, 545–546  
 bandwidth, relationship to, 537, 546  
 center frequency, relationship to, 537, 546  
 defined, 522–523, 548  
 half-power frequency, 526  
 high-pass filters, 531, 533  
 low-pass filters, 525–526

## D

Damped radian frequency, 274  
 Damping factor (coefficient), 275  
 d’Arsonval meter movement, 67–68  
 dc (constant) sources, 56  
 Decibels (dB), 737–738  
 Delta ( $\Delta$ ) interconnection, 71  
 Delta ( $\Delta$ ) connected loads, power in, 409–410  
 Delta ( $\Delta$ ) source configurations, 399–400  
 Delta to wye ( $\Delta$  to Y) equivalent circuit, 71–73, 76  
 Delta-to-wye ( $\Delta$  to Y) transformations, 324–326  
 Dependent sources, 26–27, 29, 42–45, 48, 95–96, 102–103, 116, 118  
   analysis of circuits with, 95–96, 102–103, 116, 118  
   ideal circuit elements of, 26–27, 48  
   interconnections of, 29  
   mesh-current method for, 102–103  
   node-voltage method for, 95–96  
   Thévenin equivalent of circuits with, 116, 118  
 Derived units, 9  
 Determinants, 708, 704–708  
   characteristic, 704  
   defined, 708  
   evaluation for simultaneous equations, 705–707  
   numerator, 704–705  
 Difference-amplifier circuit, 155–159, 164  
   analysis of, 155–156, 164  
   common mode input, 156–157, 164  
   common mode rejection ratio (CMRR), 157–159, 164  
   differential mode input, 156–157, 164  
 Differential mode input, 156–157, 164  
 Differentiation, operational transforms  
   for, 436–437, 656  
 Digital meters, 67, 76  
 Digital signal filtering, 643, 669  
 Direct approach analysis, 281–282, 619–621  
   steady-state response, 619–621  
   step response, 281–282  
 Dirichlet’s conditions, 605  
 Displacement current, 182  
 Dot convention, 190–193, 195–196, 203, 339–340  
   ideal transformers, 339–340  
   mutual inductance ( $M$ ), 190–193, 195–196, 203  
   mutually coupled coil polarity, 190, 203  
   procedure for, 191–192  
 Dual in-line package (DIP), 146



## E

- Effective value (eff), *see* Root-mean-square (rms) value
- Electric radiator circuits, 25, 46–46
- Electrical circuit, defined, 6
- Electrical engineering, 2–8
  - circuit theory, 6–7
  - communication systems, 4
  - computer systems, 4
  - control systems, 4–5
  - overview of, 4–8
  - power systems, 5
  - problem solving, 3, 7–8
  - role of, 2
  - signal-processing systems, 5–6
- Electrical power, transmission and distribution of, 396–397, 416–417. *See also* Balanced Three-phase circuits
- Energy ( $w$ ), 14–17, 179–181, 184–186, 197–200, 202–203, 662–669
  - capacitors, 184–186, 202
  - inductors, 179–181, 202
  - mutual inductance and storage of, 197–200, 203
  - Parseval's theorem for, 662–669
  - power ( $p$ ) and, 14–17
  - time domain calculations, 662–668
- Equivalent circuits, 58–61, 71–73, 75–76, 113–119, 129, 159–162, 187–189, 203, 320–330, 345, 477–478, 729–736
  - capacitors, 187–189, 203
  - delta to wye ( $\Delta$  to Y), 71–73, 76, 324–326
  - frequency-domain, 320–330, 345
  - ideal transformers for, 729–736
  - inductors, 187–189, 203
  - Laplace transform analysis of, 477–478
  - magnetically coupled coils and, 729–736
  - Norton, 115, 129, 327
  - operational amplifier (op amp), 159–162
  - $\pi$ -equivalent, 730–732
  - pi to tee ( $\pi$  to T), 71–73
  - resistors, 58–61, 75
  - series-parallel combinations, 58–61, 75, 187–189, 203, 320–324
  - sinusoidal steady-state analysis, 320–330, 345
  - source transformations, 115–116, 327–330
  - T-equivalent, 729–730
  - Thévenin, 113–119, 129, 327–329, 477–478
  - transformation of, 71–73, 76, 115–116
- Equivalent resistance, 58–60, 64–65
- Essential branch, 90–91, 103–104
- Essential node, 90–91, 96–97
- Even-function symmetry, 609–610, 632
- Excitation signal  $x(t)$ , 487–488
- Exponential form of Fourier series, 625–627, 633
- Exponential function, 431–432

## F

- Faraday's law, 193–194
- Feedback, op amps, 147–148, 164
- Feedback resistors, integrated amplifiers with, 291–293
- Filtering digital signals, 643, 669
- Filters, 522–524, 548–549. *See also* Active filter circuits; Frequency-selective circuits; Passive filter circuits
- Final-value theorem, 453–455, 458
- First-order active filters, 558–571
  - defined, 214, 246
  - general solutions for, 231–236, 246
  - integrating amplifier, analysis of, 241–244, 246
  - natural response of, 212, 214–224, 231–236, 246
  - pacemakers, 213, 245–246
  - resistor-capacitor ( $RC$ ), 212, 214, 220–224, 229–236, 239, 246
  - resistor-inductor ( $RL$ ), 212, 214–220, 224–228, 231–238, 246
  - sequential switching, 236–240, 243, 246
  - steady-state response of, 217
  - step response of, 212, 224–236, 246
  - time constant ( $\tau$ ), 216–217, 221, 246
  - transient response of, 217
  - unbounded response of, 240–241, 246
- Flashlight circuit model, 34–35
- Folding operation, 489–493
- Fourier series, 602–641
  - amplitude spectrum, 628–630
  - analysis, 605–606
  - application of, 617–621
  - average-power calculations, 621–624, 633
  - coefficients, 605–614, 632
  - Dirichlet's conditions, 605
  - exponential form of, 625–627, 633
  - fundamental frequency, 605, 632
  - harmonic frequency, 605, 632
  - high-Q filters, 603, 630–632
  - periodic functions and, 602–605, 609–614, 617–625, 628–630, 632–633
  - phase spectrum, 628–630
  - root-mean-square (rms) value, 624–625, 633
  - square wave input of sinusoids, 603, 630–632
  - steady-state response, 617–621, 633
  - symmetry effects, 609–614, 632
  - trigonometric alternative form of, 615–616, 632
  - waveforms, 602–604
- Fourier transform, 642–675
  - amplitude spectrum transition, 645–646
  - aperiodic functions transitions, 644–646
  - circuit applications, 659–661
  - convergence of integral, 646–648
  - cosine function, 652–653
  - defined, 644
  - derivation of, 644–646
  - elementary functions, 653



Fourier transform (Continued)  
 filtering digital signals, 643, 669  
 integral and time domain functions, 646–648, 670  
 inverse, 645  
 Laplace transforms used to find, 648–651  
 limit process for, 651–653  
 mathematical properties of, 653–655  
 operational transforms, 655–659  
 Parseval's theorem, 662–669  
 signum function, 651  
 sinusoidal steady-state response found using, 661  
 time-domain functions of, 646–648, 670  
 transient response found using, 659–660  
 unit step function, 652

Frequency ( $\omega$ ), 7, 522–523, 525–526, 528, 531, 533–537, 548–549, 605, 632  
 center or resonant ( $\omega_0$ ), 534–536, 549  
 cutoff ( $\omega_c$ ), 522–523, 525–526, 531, 533, 537, 548  
 defined, 7  
 fundamental, 605, 632  
 harmonic, 605, 632  
 high, 524  
 increasing from zero, 528  
 infinite, 528  
 low, 524  
 passband, 522–523, 548  
 regions, 529  
 stopband, 522–523, 548  
 zero, 528

Frequency domain, 311–313, 315–320, 327–341, 345, 439–442, 529, 543, 657–658. *See also s-domain*  
 convolution in, 658  
 defined, 311  
 delta-to-wye ( $\Delta$  to Y) transformations, 324–326  
 Fourier transforms for, 657–658  
 impedance (Z), 318, 320–330, 341, 345  
 inverse phasor transformation, 312–313, 345  
 Kirchhoff's laws, 319–320  
 Laplace transforms for, 439–442  
 mesh-current method, 331–332  
 node-voltage method, 330–331  
 Norton equivalent circuit, 327  
 operational transforms in, 439–440, 657–658  
 parallel impedance combinations, 322–323  
 passive circuit elements in, 315–318  
 passive-filter circuits and, 529, 543  
 phasor transformation, 311, 345  
 reactance, 318  
 s-notation for Laplace functions, 441–442  
 series impedance combinations, 320–324  
 sinusoidal steady-state analysis and, 311, 315–320, 327–341, 345  
 source transformations and, 327–330  
 Thévenin equivalent circuit, 327–329  
 time domain relationships, 529, 543  
 time domain transformations, 311–313, 345

transformers, 332–341, 345  
 translation in, 439, 657  
 voltage to current ( $v$ - $i$ ) relationships, 315–318

Frequency response, defined, 520

Frequency response plots, 522–525, 531, 535–536, 558–561  
 Bode plots, 558–561  
 magnitude plot, 522–523  
 phase angle plot, 522–523  
 series RC circuits, 531  
 series RL circuits, 524–525  
 series RLC circuits, 535–536

Frequency scale factor ( $k_f$ ), 562, 592

Frequency-selective circuits, 520–601  
 active filter circuits, 556–601  
 attenuation, 520  
 circuit symbols for, 523  
 defined, 520, 548  
 filter categories, 522–524, 548–549  
 frequency response plots for, 522–523, 560–563  
 passive filter circuits, 520–555  
 pushbutton telephones, 521, 548

Functional Laplace transforms, 429, 434–435, 457

Fundamental frequency, 605, 632

## G

Gain ( $A$ ), 147, 151, 157–158, 164  
 common mode, 157–158, 164  
 differential mode, 157–158, 164  
 op-amp voltage and, 147  
 open-loop, 151, 164

Graphical representation of complex numbers, 724–725

## H

Half-power frequency, 526

Half-wave symmetry, 611–612, 632

Harmonic frequency, 605, 632

High frequencies, 524

High-pass filters, 522–523, 530–534, 549, 560–561, 583, 592–593  
 active filter circuits, 560–561, 583, 592–593  
 Butterworth, 583, 592–593  
 cutoff frequency ( $\omega_c$ ), 531, 533  
 frequency response plots, 522–523, 531  
 operational amplifier (op amp), 560–561, 583  
 passive filter circuits, 522–523, 530–534, 549  
 qualitative analysis, 530–531  
 quantitative analysis, 531  
 series RC circuits, 530–534  
 series RL circuits, 532–534  
 transfer function  $H(s)$  for, 533–534, 549

High-Q filters, 584–589, 603, 630–632

Higher-order active filters, 571–584, 592–593

Household distribution circuit, 305, 344

Hybrid parameters, 681

## I

- Ideal basic circuit elements, 12–14, 18, 24–55, 174–211
- active, 27
  - capacitors, 174, 182–189, 203
  - closed loop (path), 38, 48
  - current ( $i$ ), 13, 26–33, 37–42
  - defined, 12–13, 18
  - dot convention, 190–192, 195–196
  - electrical resistance, 30–33, 48
  - electric radiators, 25, 46–47
  - in-series, 39, 48
  - inductors, 174, 176–182, 187–200, 203
  - Kirchhoff's laws, 37–41, 48
  - model construction, 34–36
  - mutual inductance, 176, 189–200, 203–204
  - nodes, 37–38, 48
  - passive sign convention, 13, 18, 176
  - passive, 27, 176, 203
  - polarity reference, 190–196
  - proximity switches, 175, 200–202
  - reference direction, 13
  - resistors, 30–33, 48
  - self-inductance, 176–182, 193–194, 196–197, 203
  - series-connected (in series), 39
  - series-parallel combinations, 187–189, 203
  - sources, 26–29, 42–45, 48
  - terminal equations for, 176–181, 182–186, 203
  - voltage ( $v$ ), 13, 26–29, 32–33
- Ideal transformers, 333, 336–341, 345, 380–382, 729–736
- defined, 336
  - dot convention for, 339–340
  - equivalent circuits in, 729–736
  - frequency domain, 333, 336–341, 345
  - impedance matching using, 341
  - limiting values of, 336–338
  - magnetically coupled coils and, 336–338, 729–736
  - maximum power transfer with, 381–382
  - polarity of voltage and current ratios, 339–340
  - properties of, 336
  - sinusoidal steady-state analysis, 333, 336–341, 345
  - voltage and current ratios, 338–340, 345
- Identity matrix, 712–713
- Impedance ( $Z$ ), 318, 320–330, 341, 345, 371–372, 376–380
- admittance ( $Y$ ), 322, 345
  - combined in series and in parallel, 320–324
  - complex power ( $S$ ) and, 371–372
  - defined, 318
  - delta-to-wye ( $\Delta$  to  $Y$ ) transformations, 324–326
  - equivalence of, 320–330
  - frequency domain source transformations, 320–332
  - load ( $Z_L$ ), 376–377
  - matching using ideal transformers, 341
  - maximum power transfer and, 376–380
  - Norton equivalent circuit, 327
  - reactance and, 318
  - reflected ( $Z_r$ ), 334, 345
  - self-, 333–334
  - sinusoidal steady-state analysis and, 320–332
  - sinusoidal steady-state power calculations and, 371–372, 376–380
  - source transformations and, 327–330
  - susceptance ( $B$ ), 322
  - Thévenin equivalent circuit, 327–329
  - transformers and, 333–334
- Improper rational functions, 442, 451–452
- Impulse, defined, 431
- Impulse function ( $I$ ), 431–433, 457, 496–502, 504
- capacitor circuit analysis, 496–497
  - circuit analysis using, 496–502, 504
  - circuit symbols for, 496–497
  - defined, 432, 457
  - derivatives of, 433
  - equations for  $K\delta(t)$ , 431–433, 457
  - exponential function, 431–432
  - impulsive sources, 499–502
  - inductor circuit and, 497–499
  - Laplace transform and, 431–433, 457, 496–502, 504
  - sifting property, 432
  - strength ( $K$ ) of, 431
  - switching operations for, 496–499, 504
  - unit  $\delta(t)$ , 431, 457
  - variable-parameter function, 431–432
- In-series circuit elements, *see* Series-connected circuits
- Independent sources, 26, 29, 48, 117–118
- ideal circuit elements of, 26, 48
  - interconnections of, 29
  - Thévenin equivalent of circuits with, 117–118
- Indirect approach, step response analysis, 281
- Inductance ( $L$ ), 174, 176, 187–200, 202–203
- arcing and, 176
  - circuit parameter of, 174, 176, 202
  - equivalent initial current, 188
  - Faraday's law, 193–194
  - mutual, 176, 189–200, 203
  - self-, 193–194, 196–197, 203
  - series-parallel combinations, 187–189, 203
- Inductive circuits, power calculations for, 362–363
- Inductors, 174, 176–182, 187–189, 202–203, 316–317, 466–467, 497–499, 504, 761
- behavior of, 174
  - circuit symbol for, 176
  - component values, 761
  - current ( $i$ ) in, 177–179, 202
  - energy ( $w$ ) in, 179–181, 202
  - frequency domain, 316–317
  - impulse function ( $I$ ) in, 497–499
  - Laplace transform for analysis of, 466–467, 497–499, 504
  - power ( $p$ ) in, 179–181, 202
  - $s$ -domain, 466–467, 504
  - series-parallel combinations, 187–189, 203

## Inductors (Continued)

- switching operation, 497–499
- terminal equations for, 176–181, 203, 466–467
- voltage ( $v$ ) in, 176–177, 202
- voltage to current ( $v$ - $i$ ) relationships, 176–177, 316–317

## Infinite frequency, 528

## Initial-value theorem, 453–455, 458

## Instantaneous power, 360–361, 384

## Instantaneous real power, 362

## Integer power of complex numbers, 727

- Integrals, 487–493, 504, 646–648, 670, 759–760
  - asterisk (\*) notation for, 489
  - convergence of Fourier transforms, 646–648, 670
  - convolution, 487–493, 504
  - equations of, 761–762
  - folding operation, 489–493
  - time domain functions, 646–648, 670
  - transfer function  $H(s)$  and, 487–493, 504
- Integrating amplifiers, 241–244, 246, 289–293, 295
- cascading connections, 289–293, 295
  - feedback resistors and, 291–293
  - first-order circuits with, 241–244, 246
  - response analysis of, 241–244, 289–293
  - second-order circuits with, 289–293, 295
  - sequential switching and, 243

## Integration, operational transforms for, 437–438, 656

## Integrodifferential equations, 440–442

## Interconnection of sources, 28–29

## Intermittence, 680–681

## International System of Units (SI), 8–10

## Inverse Fourier transform, 645

- Inverse Laplace transforms, 442–452, 457
- distinct complex roots of  $D(s)$ , 445–447
- distinct real roots of  $D(s)$ , 443–444
- improper rational functions, 442, 451–452
- partial fraction expansion, 442–452, 457
- proper rational functions, 442–443, 457
- rational function  $F(s)$ , 442, 457
- repeated complex roots of  $D(s)$ , 449–451
- repeated real roots of  $D(s)$ , 447–449

## Inverse of a matrix, 714

## Inverse phasor transform, 312–314, 345

## Inverting-amplifier circuit, 150–152, 160, 164

**K**

- Kirchhoff's laws, 37–41, 48, 58–59, 61, 319–320, 402–403, 406, 469
- balanced three-phase circuits using, 402–403, 406
- closed loop (path) for application of, 38, 48
- current (KCL), 37–41, 48, 319–320, 406
- frequency domain, 319–320
- parallel-connected resistors, 59, 61
- nodes, 37–38, 48
- $s$ -domain applications of, 469
- series-connected resistors, 58
- voltage (KVL), 38–41, 48, 319, 402–403

**L**

- Lagging power factor, 363
  - Laplace transform, 426–519, 648–651
  - applications of, 440–442, 470–482
  - circuit analysis using, 464–519
  - complete circuit response using, 427, 456–457
  - concept of, 428–429
  - convolution integral, 487–493, 504
  - defined, 428, 457
  - final-value theorem, 453–455, 458
  - Fourier transforms found using, 648–651
  - frequency domain and, 439
  - functional transforms, 429, 434–435, 457
  - improper rational functions, 442, 451–452
  - impulse function  $K\delta(t)$ , 431–433, 457, 496–502, 504
  - initial-value theorem, 453–455, 458
  - inverse, 442–452, 457
  - lumped-parameter circuit applications, 440–442, 457, 484
  - mutual inductance, analysis of a circuit with, 478–479
  - natural response using, 470–471
  - one-sided (unilateral), 428–429
  - operational transforms, 429, 435–440, 457
  - pairs, 434–435, 451
  - partial fraction expansion, 442–452, 457, 484–487, 504
  - poles (denominator polynomial), 452–453, 458, 484
  - proper rational functions, 442–443, 457
  - rational function  $F(s)$ , 442–453, 457–458
  - $s$ -domain, 441–455, 457–458, 466–487, 504
  - sinusoidal sources and, 427, 456–457
  - steady-state sinusoidal response, 493–495, 504
  - step function  $Ku(t)$ , 429–430, 457
  - step response using, 471–476
  - superposition, use of in  $s$ -domain, 480–482
  - surge suppressors, 465, 503
  - Thévenin equivalent, use of in  $s$ -domain, 477–478
  - time domain translation in, 439–442
  - time-invariant circuits and, 486–487, 504
  - transfer function  $H(s)$ , 482–495, 504
  - transient effects on circuits, 427, 456–457
  - transient response using, 473–474
  - unilateral (one-sided), 428–429
  - unit impulse function  $\delta(t)$ , 431, 457
  - unit step function  $Ku(t)$ , 429, 457
  - zeros (numerator polynomial), 452–453, 458, 484
- Leading power factor, 363
  - Line current, 403, 406–407
  - Line spectrum, 628
  - Line voltage, 402–404
  - Linear transformer, 333–336, 345
  - Load impedance ( $Z_L$ ), 376–377
  - Loads, 62, 408–413
  - balanced three-phase circuits and, 408–413
  - defined, 62
  - delta ( $\Delta$ ) connected, 409–410

power calculations for, 408–413  
 unspecified, 412  
 wye (Y) connected, 408–409

Loop, defined, 90–91

Low frequencies, 524

Low-pass filters, 522–530, 548, 558–560, 572–582, 592–593  
 active filter circuits, 558–560, 576–580, 592–593  
 Butterworth, 576–582, 594–595  
 cascading identical, 572–575, 592  
 cutoff frequency ( $\omega_c$ ), 526–527  
 defined, 522–530, 548  
 frequency regions, 528  
 frequency response plots, 522–525, 558–561  
 operational amplifier (op amp), 558–560, 576–580  
 passive filter circuits, 522–530, 548  
 qualitative analysis, 524–525  
 quantitative analysis, 526–527  
 relationship between frequency and time domains, 529  
 series  $RC$  circuits, 528–529  
 series  $RL$  circuits, 524–527  
 transfer function  $H(s)$  for, 529, 548

Lumped-parameter circuits, 440–442, 457, 484

Lumped-parameter system, 6–7

## M

Magnetically coupled coils, 190, 194–196, 203, 235–236, 336–338, 729–736  
 equivalent circuits for, 729–736  
 ideal transformers and, 336–338, 729–736  
 mutual inductance ( $M$ ) of, 190, 194–196, 203  
 $\pi$ -equivalent circuit, 730–732  
 step response of, 235–236  
 T-equivalent circuit, 729–730

Magnitude plot, 522

Magnitude scale factor ( $k_m$ ), 562, 592

Matrices, 707–708, 712–717  
 adjoint of, 713–714  
 column, 708  
 identity, 712–713  
 inverse of, 714  
 partitioned, 715–717  
 row, 708  
 simultaneous equation solutions from, 707–708, 712–717  
 square, 708  
 transpose of, 712

Matrix, defined, 707

Matrix algebra for simultaneous equation solutions, 708–712, 718–722

Maximum power transfer, 120–122, 129, 376–382, 384  
 average power ( $P_{\max}$ ) absorbed, 378  
 circuit analysis and, 120–122, 129  
 ideal transformer, 381–382

impedance ( $Z$ ) restricted, 378–380  
 load impedance ( $Z_L$ ) for, 376–377  
 sinusoidal steady-state analysis and, 376–382, 384

Measurement, 8–10, 66–70, 76, 413–415, 417, 737–738  
 ammeter, 66–67, 76  
 analog meters, 67, 76  
 average power ( $P$ ), 413–415, 417  
 current, 66–69  
 d'Arsonval meter movement, 67–68  
 decibel (dB) used for, 737–738  
 digital meters, 67, 76  
 International System of Units (SI), 8–10  
 power transmission, 737–738  
 resistance, 69–70, 76  
 two-wattmeter method, 413–415, 417  
 voltage, 66–69, 76  
 voltmeter, 66–67, 76  
 wattmeter, 413–415, 417  
 Wheatstone bridge, 69–70, 76

Memory and the weighting function, 492–493

Mesh, defined, 90–91

Mesh circuit, step response of, 474–477

Mesh current, defined, 100

Mesh-current method, 90, 99–109, 129, 190–192, 331–332  
 amplifier circuit analysis using, 105–106  
 circuit analysis using, 90, 99–109, 129  
 dependent sources and, 102–103  
 equations, 99–102, 190, 192  
 essential branches and, 103–104  
 frequency-domain circuits, 331–332  
 mutual inductance ( $M$ ) and, 190–192  
 node-voltage method, comparison of, 106–109  
 sinusoidal steady-state analysis using, 331–332  
 special cases of, 103–106  
 supermesh, 104

Meters, *see* Measurement

Models, 10–11, 17–18, 34–36. *See also*  
 Equivalent circuits  
 circuit, 17–18, 34–36  
 conception of, 10–11  
 construction of, 34–36  
 flashlight, 34–35  
 mathematical (circuit), 11  
 physical prototypes, 11  
 power balance, 17–18

Modulation, operational transforms for, 657

Mutual inductance ( $M$ ), 176, 189–200, 203, 478–479  
 circuit parameters of, 189–190, 194–196, 203  
 coefficient of coupling and, 197, 203  
 dot convention for polarity, 190–193, 195–196, 203  
 energy ( $w$ ) storage and, 197–200, 203  
 Laplace transform analysis and, 478–479  
 magnetically coupled coils and, 190, 194–196, 203  
 mesh-current equations for, 190–192  
 s-domain using, 478–479  
 self-inductance and, 193–194, 196–197, 203



## N

Narrowband filters, 584–589, 593  
 bandpass filters, 584–586  
 bandreject, 586–589  
 quality factor ( $Q$ ) and, 584–589  
 twin-T notch filter, 586–589

Natural response, 212, 214–224, 231–236, 246, 266–279, 285–289, 295, 470–471  
 critically damped voltage, 269, 277–278, 286, 295  
 current ( $i$ ) determined for, 214–216, 286  
 defined, 212, 246  
 first-order circuits, 212, 214–224, 231–236, 246  
 forms of in  $RLC$  circuits, 270–279  
 general solution for, 231–236, 246, 266–270  
 Laplace transform analysis and, 470–471  
 method of calculating, 232  
 overdamped voltage, 269, 271–273, 286, 295  
 parallel  $RLC$  circuit, 266–279, 295  
 resistor-capacitor ( $RC$ ) circuits, 220–224, 231–236, 246, 470–471  
 resistor-inductor ( $RL$ ) circuits, 214–220, 231–236, 246  
 resistor-inductor-capacitor ( $RLC$ ) circuits, 266–279, 285–289, 295  
 series  $RLC$  circuits, 285–289, 295  
 time constant ( $\tau$ ), 216–217, 221, 246  
 underdamped voltage, 269, 274–277, 286–288, 295  
 voltage ( $v$ ) determined for, 221

Negative (acb) phase voltage sequence, 398

Neper frequency ( $\alpha$ ) for, 268–269, 286

Neutral terminal, 399

Node-voltage equation ( $\mathbf{V}_N$ ), 400–401

Node-voltage method, 90, 93–99, 106–109, 129, 330–331  
 amplifier circuit analysis using, 98–99  
 circuit analysis using, 90, 93–99, 106–109, 129  
 dependent sources and, 95–96  
 equations, 93–94, 129  
 essential nodes and, 96–97  
 frequency-domain circuits, 330–331  
 mesh-current method, comparison of, 106–109  
 sinusoidal steady-state analysis using, 330–331  
 special cases for, 96–99  
 supernode, 97–98

Nodes, 37–38, 48, 90–91, 93–94  
 circuit element, 37–38, 48  
 defined, 37, 90–91  
 essential, 91  
 voltage, 93–94

Noninverting-amplifier circuit, 153–154, 160–161, 164

Nonplanar circuits, 90–91

Norton equivalent circuits, 115, 129, 327  
 analysis of, 115, 129  
 defined, 115  
 frequency-domain source transformations, 327  
 impedance ( $Z$ ) in, 327  
 source transformations used for, 115

Numerator determinant, 704–705

## O

Octave, 744

Odd-function symmetry, 610–611, 614, 632

Ohm's law, 30–31, 48, 59, 468–469  
 electrical resistance and, 30–31, 48, 59  
 $s$ -domain applications of, 468–469

One-sided (unilateral) Laplace transform, 428–429

Open circuit, 35

Open-loop gain ( $A$ ), 151, 164

Operational amplifiers (op amps), 144–173, 556–601  
 bandpass filters, 564–568, 583–586, 592–593  
 bandreject filters, 568–571, 583, 586–589, 592–593  
 bass volume control, 557, 589–591  
 broadband filters, 565–571, 592  
 Butterworth filters, 576–584, 592–593  
 cascading, 564–574, 592  
 circuit symbol for, 146  
 currents ( $i$ ), 146–150  
 difference-amplifier circuit, 155–159, 164  
 dual in-line package (DIP), 146  
 equivalent (realistic model), 159–162, 164  
 negative feedback, 147–148, 164  
 filters, 556–601  
 first-order filters, 558–562  
 gain ( $A$ ), 147, 151, 157–158, 164  
 high-pass filters, 560–561, 583, 592  
 higher-order filters, 571–584, 592–593  
 input constraints, 147–148, 164  
 inverting-amplifier circuit, 150–152, 160, 164  
 low-pass filters, 558–560, 576–582, 592–593  
 noninverting-amplifier circuit, 153–154, 160–161, 164  
 realistic model (equivalent), 159–162, 164  
 resistance ( $R$ ) and, 145, 162–163  
 scaling, design of using, 563–564  
 simplified, 146–159, 164  
 strain gages for, 145, 162–163  
 summing-amplifier circuit, 152–153, 164  
 terminals, 146–150  
 transfer characteristics, 147  
 voltages ( $v$ ), 146–150, 164

Operational transforms, 429, 435–440, 457, 655–659  
 addition, 436, 656  
 amplitude modulation, 657  
 convolution, 657–658  
 defined, 429  
 differentiation, 436–437, 656  
 Fourier, 655–659  
 frequency domain functions, 439, 657–658  
 integration, 437–438, 656  
 Laplace, 431, 437–442, 459  
 modulation, 657  
 multiplication by a constant, 435, 655  
 scale changing, 439, 657  
 subtraction, 436, 656  
 time domain functions, 438–439, 655–659  
 translation, 438–439, 657  
 types of, 440, 658

Overdamped responses, 269, 271–273, 282, 286, 295–296  
 natural response equations, 271–273, 295  
 parallel RLC circuits, 269, 271–273, 282, 295  
 series RLC circuits, 286, 295  
 step response equations, 286, 296

## P

- Pacemaker circuits responses, 213, 245–246  
 Parallel-connected circuits, 59–61, 75, 187–189, 203, 322–323, 692. *See also* Parallel RLC circuits  
 capacitors, 188–189, 203  
 impedances combined in, 322–323  
 inductors, 187–188, 203  
 Kirchhoff's law for, 59, 61  
 Ohm's law for, 59  
 resistors, 59–61, 75  
 two-port circuits, 692  
 Parallel RLC circuits, 266–285, 295–296, 471–474  
 characteristic equation for, 267, 269–270, 295  
 circuit symbols for, 266, 280  
 critically damped responses, 269, 277–278, 283, 295  
 direct approach for, 281–282  
 general solution of differential equations, 266–270  
 indirect approach for, 281  
 Laplace transform analysis of, 471–474  
 natural response, 266–279, 295  
 Neper frequency ( $\alpha$ ) for, 268–269  
 overdamped responses, 269, 271–273, 282, 295  
 resonant radian frequency ( $\omega_0$ ), 268–269  
 s-domain, 471–474  
 step response, 280–285, 295–296, 471–473  
 transient response, 473–474  
 underdamped responses, 269, 274–277, 283, 295  
 Parallel-series two-port circuit connection, 692  
 Parameters of two-port circuits, 679–686, 696  
 Parseval's theorem, 662–669  
 filter applications of, 665–666  
 Fourier transform and, 662–669  
 graphic interpretation of, 663–664  
 rectangular voltage pulse analysis using, 666–668  
 time-domain energy calculations, 662–668  
 Partial fraction expansion, 442–452, 457, 484–487, 504  
 distinct complex roots of  $D(s)$ , 445–447  
 distinct real roots of  $D(s)$ , 443–444  
 improper rational function, 442, 451–452  
 inverse Laplace transforms in, 442–452, 457  
 Laplace transform analysis and, 484–487, 504  
 Laplace transform pairs for, 451  
 proper rational functions, 442–443, 457  
 repeated complex roots of  $D(s)$ , 449–451  
 repeated real roots of  $D(s)$ , 447–449  
 time invariant circuits, 486–487, 504  
 transfer function  $H(s)$  in, 484–487, 504  
 Partitioned matrix, 715–717  
 Passband frequencies, 522–523, 548  
 Passive current elements, 27, 176, 202, 315–318  
 capacitors, 176, 202, 317–318  
 defined, 27  
 frequency domain, 315–318  
 ideal sources, 27  
 impedance ( $Z$ ), 318  
 inductors, 176, 202, 316–317  
 reactance, 318  
 resistors, 315–316  
 voltage to current ( $v-i$ ) relationships, 315–318  
 Passive filter circuits, 520–555  
 bandpass filters, 523, 534–543, 549  
 bandreject filters, 523, 543–547, 549  
 bandwidth ( $\beta$ ), 535, 537, 545–546, 549  
 center (resonant) frequency ( $\omega_0$ ), 534–536, 545–546, 549  
 cutoff frequency ( $\omega_c$ ), 522–523, 525–526, 531, 533, 537, 545–546, 548  
 defined, 523–524  
 filtering capabilities of, 523–524  
 frequency response and, 520,  
 frequency response plots, 522–523  
 high-pass filters, 522–523, 530–534, 549  
 low-pass filters, 522–530, 548  
 magnitude plot, 522  
 qualitative analysis, 524–525  
 quantitative analysis, 526–527  
 passband frequencies, 522–523, 548  
 phase angle plot, 522  
 pushbutton telephones, 521, 548  
 quality factor ( $Q$ ), 535, 538, 545, 549  
 relationship between frequency and time domains, 529, 543  
 stopband frequencies, 522–523, 548  
 transfer function  $H(s)$  for, 522, 529, 533–534, 542, 544–545, 547–549  
 Passive sign convention, 13, 18  
 Path, defined, 90–91  
 Per-phase quantity ( $\phi$ ), 403  
 Period, sinusoidal sources, 306  
 Periodic functions, 602–605, 609–614, 617–625, 628–630, 632–633, 644–646  
 amplitude spectrum of, 628–630  
 aperiodic function transition from, 644–646  
 average-power calculations, 621–624, 633  
 defined, 602, 632  
 Fourier coefficients and, 605, 609–614  
 Fourier series application of, 617–621  
 Fourier series representation of, 605  
 Fourier transforms and, 644–646  
 phase spectrum of, 628–630  
 root-mean-square (rms) value, 624–625, 633  
 steady-state response using, 617–621  
 symmetry effects, 609–614, 632  
 waveforms, 602–604  
 Phase angle ( $\phi$ ), 306  
 Phase angle plots, 522, 745–474, 753–755  
 Phase current, 403, 405–407  
 Phase spectrum, 628–630

Phase voltage, 398, 402–404  
 Phasor diagrams, 342–344, 403, 406  
 Phasors, 310–315, 345  
   defined, 310  
   frequency domain and, 311, 345  
   inverse transform, 312–314, 345  
   sinusoidal steady-state analysis and, 310–315, 345  
   transform, 311, 345  
 Pi ( $\pi$ )-equivalent circuit, 730–732  
 Pi ( $\pi$ ) interconnection, 71  
 Pi to tee ( $\pi$  to T) equivalent circuit, 71–73  
 Planar circuits, 90–91  
 Polar form of complex numbers, 723–724  
 Polarity, 15–16, 190–192, 195–196, 203, 339–340  
   dot convention for, 190–192, 195–196, 203, 341–342  
   ideal transformers, 339–340  
   mutual inductance, 190–192, 195–196, 203  
   power references, 15–16  
   voltage and current ratios, 339–340  
 Poles (roots), 452–453, 458, 484, 739–740, 747–749  
   Bode plots and, 739–740, 747–749  
   complex, 747–749  
   defined, 452  
   rational function  $F(s)$ , 452–453, 457  
   real, first order, 739–740  
   transfer function  $H(s)$ , 484  
 Ports, 676  
 Positive (abc) phase voltage sequence, 398  
 Potential coil, 413  
 Power ( $p$ ), 14–18, 31–32, 48, 120–122, 129, 179–181,  
   183–186, 202, 359, 382–383, 397, 413–415, 417, 737–738  
   algebraic signs of, 15–16  
   balancing, model for, 17–18  
   capacitors, 183–186, 202  
   defined, 15, 18  
   decibel (dB) used for, 737–738  
   electrical, transmission and distribution of, 397, 416–417  
   energy ( $w$ ) and, 14–17  
   inductors, 179–181, 202  
   maximum transfer, 120–122, 129  
   measurement of, 413–415, 417, 737–738  
   polarity references, 15–16  
   resistors and, 31–32, 48  
   standby (vampire), 359, 382–383  
   wattmeter, 413–415, 417  
 Power calculations, 358–395, 408–413, 417, 621–624, 633  
   apparent power, 368, 384  
   appliance ratings, 365  
   average (real) power ( $P$ ), 361–365, 371–373, 384,  
     408–409, 621–624, 633  
   balanced three-phase circuits, 408–413, 417  
   balancing from an ac circuit, 374–375  
   capacitive circuits, 363  
   complex power ( $S$ ), 368–372, 384, 409  
   delta ( $\Delta$ ) connected loads, 409–410  
   equations for, 369–376  
   inductive circuits, 362–363

instantaneous power, 360–361, 384  
 maximum power transfer, 376–382, 384  
 parallel loads, 373–374  
 periodic functions and, 621–624, 633  
 power factor (pf), 363, 384  
 reactive factor (rf), 363, 384  
 reactive power ( $Q$ ), 361–365, 371–373, 384  
 resistive circuits, 362  
 root-mean-square (rms) value, 366–367  
 sinusoidal steady-state analysis, 358–395  
 three-phase circuits, 408–413, 417  
 standby (vampire) power, 359, 382–383  
 wye (Y) connected loads, 408–409  
 unspecified loads, 412  
 Power equation, 15  
 Power factor (pf), 363, 384  
 Power systems, 5  
 Primary winding, transformers, 333  
 Problem solving strategy, 3, 7–8  
 Pushbutton telephone circuits, 521, 548

## Q

Qualitative analysis, 524–525, 531, 535–536, 544  
   bandpass filters, 535–536  
   bandreject filters, 544  
   high-pass filters, 531  
   low-pass filters, 524–525  
 Quality factor ( $Q$ ), 537, 539, 545, 549, 584–585  
   active (narrowband) filter circuits, 584–585  
   passive filter circuits, 537, 539, 545, 549  
 Quantitative analysis, 526–527, 530–531, 536–538,  
   544–547  
   bandpass filters, 536–538  
   bandreject filters, 544–547  
   high-pass filters, 530–531  
   low-pass filters, 526–527  
 Quarter-wave symmetry, 612–613, 632

## R

Rational function  $F(s)$ , 442–453, 457–458  
   defined, 442  
   partial fraction expansion of, 442–452, 457  
   poles of, 452–453, 458  
   zeros of, 452–453, 458  
 RC circuits, *see* Resistor-capacitor (RC) circuits  
 Reactance, impedance and, 318  
 Reactive factor (rf), 363, 384  
 Reactive power ( $Q$ ), 361–365, 371–373, 384. *See also*  
   Power calculations  
 Real first-order poles and zeros, 739–740  
 Real models, *see* Equivalent circuits  
 Real power, *see* Average power  
 Reciprocal two-port circuits, 685–686, 696  
 Rectangular (Cartesian) form of complex numbers, 723  
 Reflected impedance ( $Z_r$ ), 334, 345

- Resistance ( $R$ ), 30–33, 48, 69–70, 113–115, 145, 162–163  
 conductance ( $G$ ) and, 31, 60  
 equivalent, 58–60, 64–65  
 measurement of, 69–70  
 Ohm's law, 30–31, 48  
 operational amplifiers (op amps), 145, 162–163  
 resistors as models of, 30–33, 48  
 strain gages for, 145, 162–163  
 Thévenin equivalent ( $R_{Th}$ ), 113–115
- Resistive circuits, 56–87, 362  
 constant (dc) sources, 56  
 current-divider, 63, 75  
 current-division analysis, 64–66, 75–76  
 delta to wye ( $\Delta$  to  $Y$ ) equivalent, 71–73, 76  
 load, 62  
 measurement of voltage and current in, 66–69, 76  
 parallel-connected (in parallel), 59–61, 75  
 pi to tee ( $\pi$  to  $T$ ) equivalent, 71–73  
 power calculations for, 362  
 resistors, 58–61, 75  
 series-connected (in series), 58, 75  
 touch screens, 57, 73–75  
 voltage-divider, 61–62, 75  
 voltage-division analysis, 64–66, 75  
 Wheatstone bridge, 69–70, 76
- Resistor-capacitor ( $RC$ ) circuits, 212, 214, 220–224, 229–236, 239, 246, 470–471, 528–534  
 circuit symbols for, 214, 220  
 cutoff frequency, 531, 533  
 defined, 212  
 frequency response plot of, 531  
 general solution for responses of, 231–236, 246  
 high-pass filters, behavior of as, 530–534  
 Laplace transform analysis of, 470–471  
 low-pass filters, behavior of as, 528–529  
 natural response of, 220–224, 231–236, 246, 470–471  
 qualitative analysis of series, 530–531  
 quantitative analysis of series, 531  
 $s$ -domain, 470–471  
 sequential switching, 236, 239  
 step response, 229–236, 246  
 time constant ( $\tau$ ), 221, 246  
 unbounded response, 240–241  
 voltage ( $v$ ), deriving expression for, 221
- Resistor-inductor ( $RL$ ) circuits, 212, 214–220, 224–228, 231–238, 246, 524–527, 532–534  
 circuit symbol for, 214  
 current ( $i$ ), deriving expression for, 214–216  
 cutoff frequency, 525–527, 533  
 defined, 212  
 frequency response plots of, 524–525  
 general solution for responses of, 231–236, 246  
 high-pass filters, behavior of as, 530–534  
 low-pass filters, behavior of as, 524–527  
 natural response of, 214–220, 231–236, 246  
 qualitative analysis of series, 524–525  
 quantitative analysis of series, 526–527  
 sequential switching, 236–238  
 steady-state response, 217  
 step response, 224–228, 231–236, 246  
 time constant ( $\tau$ ), 216–217, 246  
 transient response, 217
- Resistor-inductor-capacitor ( $RLC$ ) circuits, 264–303, 471–474, 535–547  
 bandpass filters, behavior of as, 535–543  
 bandreject filters, behavior of as, 543–547  
 characteristic equation for, 267, 269–270, 286, 295  
 circuit symbols for, 266, 285–286  
 critically damped voltage responses, 269, 277–278, 283, 286, 295–296  
 cutoff frequency ( $\omega_c$ ), 537, 545–546  
 clock for computer timing, 265, 293–294  
 frequency response plots, 535–536, 544  
 frequency selective circuits, 535–547  
 Laplace transform, analysis of using, 471–474  
 natural response of, 266–279, 285–289, 295  
 Neper frequency ( $\alpha$ ) for, 268–269, 286  
 overdamped voltage responses, 269, 271–273, 282, 286, 295–296  
 parallel, 266–285, 295, 471–474  
 qualitative analysis of series, 535–536, 544  
 quantitative analysis of series, 536–538, 544–547  
 resonant radian frequency ( $\omega_0$ ), 268–269, 286  
 $s$ -domain, 471–474  
 series, 285–289, 295–296  
 step response of, 280–289, 295–296, 471–473  
 transfer function  $H(s)$  for, 542, 544–545, 547, 549  
 transient response of, 473–474  
 underdamped voltage response, 269, 274–277, 283, 286–288, 295–296
- Resistors, 30–33, 48, 58–61, 75, 89, 125–128, 291–293, 315–316, 466, 504, 761  
 black box, 58  
 circuit symbol for, 31  
 component values, 761  
 conductance ( $G$ ) and, 31  
 defined, 30, 48  
 electrical resistance and, 30–33, 47–48  
 feedback, 291–293  
 frequency domain, 315–316  
 integrating amplifiers with, 291–293  
 Laplace transforms for analysis of, 466, 504  
 parallel-connected (in parallel), 59–61, 75  
 power terminals of, 31–32, 48  
 resistance ( $R$ ) and, 30–33, 48  
 $s$ -domain, 466, 504  
 sensitivity analysis, 89, 125–128  
 series-connected (in series), 58, 75  
 time and frequency domain elements, 466  
 voltage to current ( $v$ - $i$ ) relationships, 315–316
- Resonant radian frequency ( $\omega_0$ ), 268–269, 286. *See also* Center frequency ( $\omega_0$ )



Response, 212–303, 309–310, 345, 427, 456–457, 470–482, 493–495, 503–504, 520, 659–661  
 clock for computer timing, 265, 293–294  
 complete, 427, 456–457  
 first-order circuits, 212–263  
 Fourier transform for, 659–661  
 frequency, 520  
 general solutions for, 231–236, 246  
 integrating amplifiers, 241–244, 246, 289–293, 295  
 Laplace transform used for, 427, 456–457, 470–482, 495–497, 503  
 multiple mesh circuits, 474–476  
 natural, 212, 214–224, 231–236, 246, 266–279, 285–289, 295, 470–471  
 pacemaker circuits, 213, 245–246  
 parallel *RLC* circuits, 266–285, 295–296, 471–474  
 resistor-capacitor (*RC*) circuits, 212, 214, 220–224, 229–236, 239, 246, 470–471  
 resistor-inductor (*RL*) circuits, 212, 214–220, 224–228, 231–238, 246  
 resistor-inductor-capacitor (*RLC*) circuits, 264–303, 471–474  
 second-order circuits, 264–303  
 sequential switching, 236–240, 243, 246  
 series *RLC* circuits, 285–289, 295–296  
 sinusoidal, 309–310, 345, 493–495, 503–504, 661  
 steady-state, 217, 427, 493–495, 503–504, 661  
 step, 212, 224–236, 246, 280–289, 295–296, 471–476  
 transfer function and, 493–495, 503–504, 661  
 transient, 217, 427, 473–474, 659–660  
 unbounded, 240–241, 246  
*RL* circuits, *see* Resistor-inductor (*RL*) circuits  
*RLC* circuits, *see* Resistor-inductor-capacitor (*RLC*) circuits  
 Root-mean-square (rms) value, 307–309, 366–367, 624–625, 633  
 effective value (eff) as, 366–367  
 periodic functions, 624–625, 633  
 power calculations and, 366–367  
 sinusoidal sources, 307–309  
 Roots, 443–453, 458, 727–728  
 complex numbers, 443–451, 727–728  
 distinct complex, 445–447  
 distinct real, 443–444  
 Laplace transform pairs for, 451  
 partial fraction expansion of  $D(s)$ , 442–451, 458  
 repeated complex, 449–451  
 poles (denominator polynomial), 452–453, 458  
 repeated real, 447–449  
 zeros (numerator polynomial), 452–453, 458  
 Row matrix, 708

## S

*s*-domain, 441–455, 457–458, 466–502, 504  
 capacitor in, 467–468, 504  
 circuit analysis in, 468–482, 504  
 circuit symbols for, 466–467, 470–471, 475, 477, 479–480

final-value theorem, 453–455, 458  
 impulse function  $K\delta(t)$  in, 496–502, 504  
 inductor in, 466–467, 504  
 initial-value theorem, 453–455, 458  
 inverse Laplace transform and, 442–452, 457  
 Kirchhoff's laws and, 469  
 Laplace transform and, 441–455, 457–458, 466–487, 504  
 mutual inductance in, 478–479  
 notation of in Laplace transforms, 441–442  
 Ohm's law in, 468–469  
 partial fraction expansion, 442–452, 457, 484–487, 504  
 poles (denominator polynomial), 452–453, 458  
 resistor in, 466, 504  
 responses of circuits in, 470–482  
 superposition, use of in, 480–482  
 terminal voltage-current equations in, 466–468, 504  
 Thévenin equivalent, use of in, 477–478  
 transfer function  $H(s)$  in, 482–495, 504  
 zeros (numerator polynomial), 452–453, 458  
 Scale-changing property, operational transforms, 439, 657  
 Scaling, 562–564, 592  
 frequency factor ( $k_f$ ), 562, 592  
 magnitude factor ( $k_m$ ), 562, 592  
 op-amp filter design using, 563–564  
 Second-order circuits, 264–303  
 defined, 266  
 general solution of differential equations, 266–270  
 integrating amplifiers, 289–293, 295  
 natural response of, 266–279, 285–289, 295  
 resistor-inductor-capacitor (*RLC*), 264–303  
 step response of, 280–289, 295–296  
 Secondary winding, transformers, 333  
 self-impedance ( $Z$ ), 333–334  
 Self-inductance, 193–194, 196–197, 203  
 Sensitivity analysis, resistors, 89, 125–128  
 Sequential switching, 236–240, 243, 246  
 first-order circuit responses and, 236–240, 243, 246  
 integrating amplifier with, 243  
 resistor-capacitor (*RC*) circuits, 236, 239  
 resistor-inductor (*RL*) circuits, 236–238  
 Series-connected (in series) circuits, 39, 48, 58, 75, 187–189, 203, 320–324, 692. *See also* Series *RLC* Circuits  
 black box concept, 58  
 capacitors, 188–189, 203  
 impedances combined in, 320–324  
 inductors, 187–188, 203  
 Kirchhoff's current law for, 39, 48, 58  
 node positions, 39, 48  
 resistors, 58, 75  
 two-port circuits, 692  
 Series-parallel two-port circuit connection, 692  
 Series *RLC* circuits, 285–289, 295–296  
 capacitor voltage in, 286–287  
 characteristic equation of, 286, 295  
 circuit symbols for, 285–286  
 critically damped response, 286  
 natural response, 285–289

- Neper frequency ( $\alpha$ ), 286
- overdamped response, 286
- resonant radian frequency ( $\omega_0$ ), 286
- step response, 285–289, 295–296
- underdamped responses, 286–288
- Short circuit, 35
- Sifting property, 432
- Signal-processing systems, 5–6
- Signed minor, 705–706
- Signum function, Fourier transform of, 651
- Simultaneous equations, 91–93, 703–722
  - characteristic determinant, 704
  - circuit analysis using, 91–93
  - Cramer’s method, 704
  - determinant evaluation for, 705–708
  - determination of number of, 91–92
  - matrices for, 707–708, 712–717
  - matrix algebra for, 708–712, 718–722
  - numerator determinant, 704–705
  - solution of, 703–722
  - systematic approach using, 92–93
- Sine functions, 615–616
- Single-phase equivalent circuits, 402–403, 417
- Sinusoidal response, 309–310, 345, 465, 495–497, 503, 506, 661
  - Fourier transform for, 661
  - Laplace transform for, 465, 495–497, 503
  - steady-state analysis and, 309–310, 345
  - steady-state component of, 310
  - surge suppressors, 465, 503
  - transfer function  $H(s)$  and, 495–497, 506
  - transient component of, 312
- Sinusoidal sources, 306–309, 345, 427, 456–457
  - complete circuit response of, 427, 456–457
  - current ( $i$ ), 306–307, 345
  - Laplace transforms for, 427, 456–457
  - period, 306
  - phase angle ( $\phi$ ), 306
  - root-mean-square (rms) value of, 307–309
  - steady-state analysis, 306–309, 345
  - voltage ( $v$ ), 306–308, 345
- Sinusoidal steady-state analysis, 304–395
  - delta-to-wye ( $\Delta$ -to-Y) transformations, 324–326
  - frequency domain, 311, 315–320, 327–341, 345
  - household distribution circuit, 305, 344
  - ideal transformer, 336–341, 345
  - impedance ( $Z$ ), 318, 320–330, 334, 341, 345
  - Kirchhoff’s laws, 319–320
  - mesh-current method, 331–332
  - node-voltage method, 330–331
  - Norton equivalent circuit, 327
  - passive circuit elements, 315–318
  - phasor diagrams for, 342–344
  - phasors, 310–315, 345
  - power calculations, 358–395
  - reactance, 318
  - response, 309–310, 345
  - source transformations, 327–330
    - sources, 306–309, 345
    - standby (vampire) power, 359, 382–383
    - Thévenin equivalent circuit, 327–330
    - transformers, 332–341, 345
    - voltage to current ( $v$ - $i$ ) relationships, 315–318
- Source transformations, 109–113, 115–116, 129, 327–330
  - circuit analysis using, 109–113, 115–116, 129
  - defined, 110
  - frequency domain, 327–330
  - impedance ( $Z$ ) and, 327–330
  - Norton equivalent circuits, 115, 327
  - Thévenin equivalent circuit, 115–116, 327–329
- Sources, 26–29, 42–45, 48, 56, 306–309, 345, 399–400, 427, 456–457, 499–502
  - active element of, 27
  - complete circuit response and, 427, 456–457
  - constant (dc), 56
  - controlled, 27
  - delta ( $\Delta$ ) configurations, 399–400
  - dependent, 26–27, 29, 42–45, 48
  - ideal current, 26–29, 48
  - ideal voltage, 26–29, 48
  - impulsive, 499–502
  - independent, 26, 29, 48
  - interconnection of, 28–29
  - Laplace transform and, 427, 456–457, 499–502
  - passive element of, 27
  - sinusoidal, 306–309, 345, 427, 456–457
  - three-phase voltage, 399–400
  - wye (Y) configurations, 399–400
- Square matrix, 708
- Square wave input of sinusoids, 603, 630–632
- Standby (vampire) power, 359, 382–383
- Steady-state analysis, *see* Sinusoidal steady-state analysis
- Steady-state response, 217, 427, 456–457, 493–495, 503–504, 617–621, 633, 661
  - defined, 217
  - direct approach to, 619–621
  - first-order circuits, 217
  - Fourier series analysis, 617–621, 633
  - Fourier transform for, 661
  - Laplace transform analysis and, 493–495, 504
  - periodic functions used for, 617–621
  - sinusoidal, 493–495, 503–504, 661
  - surge suppressors and, 465, 503
  - transfer function  $H(s)$  and, 493–495, 504
  - transient effects and, 427, 456–457
- Step function  $Ku(t)$ , 429–430, 457
- Step response, 212, 224–236, 246, 280–289, 295–296, 471–476
  - capacitor voltage in series  $RLC$  circuits, 286–287
  - critically damped voltage, 283, 295–296
  - defined, 212, 246
  - direct approach, 281–282
  - first-order circuits, 212, 224–236, 246
  - general solution for, 231–236, 246
  - indirect approach, 281
  - Laplace transform analysis and, 471–476

## Step response (Continued)

- magnetically coupled coils and, 235–236
- method of calculating, 232
- multiple mesh circuit, 474–476
- overdamped voltage, 282, 295–296
- parallel  $RLC$  circuits, 280–285, 295–296, 471–473
- resistor-capacitor ( $RC$ ) circuits, 229–236, 246
- resistor-inductor ( $RL$ ) circuits, 224–228, 231–236, 246
- resistor-inductor-capacitor ( $RLC$ ) circuits, 280–289, 295–296
- series  $RLC$  circuits, 285–289, 295–296
- underdamped, 283, 288, 295–296

## Stopband frequencies, 522–523, 548

## Straight-line amplitude plots, 740–744, 750–752

## Straight-line phase angle plots, 745–747

## Strain gages, 145, 162–163

## Summing-amplifier circuit, 152–153, 164

## Supermesh, 104

## Supernode, 97–98

## Superposition, 122–125, 129, 480–482

- circuit analysis using, 122–125, 129

- defined, 122

- Laplace transform analysis and, 480–482

- s-domain, 480–482

## Surge suppressors, 465, 503

Susceptance ( $B$ ), 322

## Switches, 176, 232–240, 243, 465, 496–499, 503

- arcing, 176

- capacitor circuits, 496–497

- inductor circuits, 176, 497–499

- impulse functions created by, 496–499

- integrating amplifier with, 243

- Laplace transform analysis and, 465, 496–499, 503

- $RL$  and  $RC$  circuits, 232–240, 246

- sequential switching, 236–240, 246

- surge suppressors, 465, 503

## Symmetric two-port circuits, 686, 696

## Symmetry, 609–614, 632

- even-function, 609–610, 632

- Fourier coefficients, effects on, 609–614, 632

- half-wave, 611–612, 632

- odd-function, 610–611, 614, 632

- quarter-wave, 612–613, 632

## T

## T-equivalent circuit, 729–730

## Tee (T) interconnection, 71

## Terminals, 31–32, 36, 146–150, 164, 182–186, 203, 466–468, 678

- capacitor equations, 182–186, 203, 467–468

- current ( $i$ ) input constraints, 148–149, 164

- inductor equations, 176–181, 203, 466–467

- measurements for circuit construction, 36

- operation amplifiers (op amps), 146–150, 164

- resistor power at, 31–32

- two-port circuits, 678

- variable characteristics (voltage and current), 146–150, 164

- voltage ( $v$ ) input constraints, 147–148, 164

## Terminated two-port circuits, 687–691

## Thévenin equivalent circuits, 113–119, 129,

- 327–329, 477–478

- amplifier circuit using, 118–119

- analysis of, 113–119, 129

- defined, 113

- dependent sources, 116, 118

- finding equivalent of, 114–115

- frequency-domain, 327–329

- impedance ( $Z$ ) in, 327–329

- independent sources, 117–118

- Laplace transform analysis and, 477–478

- resistance source ( $R_{Th}$ ), 113–115

- s-domain, use of in, 477–478

- source transformations used for, 115–116,

- 327–329

- voltage source ( $V_{Th}$ ), 113–115

- test source for, 118

Three-phase circuits, *see* Balanced three-phase circuitsTime constant ( $\tau$ ), 216–217, 221, 246

- resistor-capacitor ( $RC$ ) circuits, 221, 246

- resistor-inductor ( $RL$ ) circuits, 216–217, 246

## Time domain, 311–313, 345, 438–442, 529, 543, 646–648, 655–659, 662–668

- convergence of Fourier transform integral and, 646–648

- convolution in, 657–658

- differentiation in, 656

- energy calculations, 662–668

- Fourier transform and, 646–648, 655–659, 664–670

- frequency domain relationships, 529, 543, 657

- frequency domain transformations, 311–313, 345

- integration in, 656

- integrodifferential equations for, 440–442

- inverse phasor transformation, 312–313, 345

- Laplace transform and, 438–442

- operational transforms for, 438–439, 655–659

- Parseval's theorem for, 662–668

- passive-filter circuits and, 529, 543

- phasor transformation, 311, 345

- scale change in, 657

- translation in, 438–439, 657

## Time-invariant circuits, 486–487, 504

## Tolerance, 62

## Touch screens, 57, 73–75, 175, 200–202

- capacitance of, 175, 200–202

- resistive circuits of, 57, 73–75

## Transducers (strain gages), 145, 162–163

Transfer function  $H(s)$ , 482–495, 504, 529, 533–534, 544–545, 547–549, 569, 572–579, 583–584, 592

- active-filter circuits, 569, 572–577, 584, 592

- bandpass filters, 542, 549, 569, 584

- bandreject filters, 544–545, 547, 549

Butterworth filters, 576–579, 583, 592  
 cascading identical filters and, 572–575  
 circuit analysis, 482–495, 504  
 convolution integral and, 487–493, 504  
 defined, 482  
 high-pass filters, 533–534, 549  
 Laplace transform circuit analysis and, 482–495, 504  
 low-pass filters, 529, 548  
 memory and, 492–493  
 partial fraction expansion, use of in, 484–487, 504  
 passive-filter circuits and, 529, 533–534, 542, 544–545, 547–549  
 poles of, 484  
 steady-state sinusoidal response and, 493–495, 504  
 time-invariant circuits, 486–487, 504  
 weighting function, 492–493  
 zeros of, 484  
 Transformations, *see* Circuit transformations  
 Transformers, 332–341, 345, 729–736  
   defined, 332  
   dot convention for, 339–340  
   equivalent circuits and, 729–736  
   frequency domain and, 332–341, 345  
   ideal, 333, 336–341, 345, 729–736  
   self-impedance ( $Z$ ), 333–334  
   limiting values of, 336–338  
   linear, 333–336, 345  
   winding (primary and secondary), 333  
   reflected impedance ( $Z_r$ ), 334, 345  
   sinusoidal steady-state analysis, 332–341, 345  
   voltage and current ratios, 338–340, 345  
 Transient effects on circuits, 427, 456–457  
 Transient response, 217, 473–474, 659–660  
   defined, 217  
   Laplace transform for, 473–474  
   Fourier transform for, 659–660  
 Translation, operational transforms for, 438–439, 657  
 Transmission parameters, 681  
 Transpose of a matrix, 712  
 Trigonometric identities, 757  
 Twin-T notch filter, 586–589  
 Two-port circuits, 676–701  
   analysis of, 687–691  
   black box amplifier, 677, 695  
   conversion of parameters, 684–686  
   hybrid parameters, 681  
   interconnected, 692–695  
   intermittence, 680–681  
   parameter conversion for, 682–684  
   parameters of, 679–686, 696  
   ports, 676  
   reciprocal, 685–686, 696  
   symmetric, 686, 696  
   terminal equations for, 678  
   terminated, 687–691  
   transmission parameters, 681  
    $z$  parameters, 679–680, 687–691

## U

Unbounded response, 240–241, 246  
 Underdamped responses, 269, 274–277, 283, 286–288, 295–296  
   characteristics of, 276  
   damped radian frequency, 274  
   damping factor (coefficient), 275  
   natural response equations, 274–275, 295  
   parallel  $RLC$  circuits, 269, 274–277, 283, 295  
   series  $RLC$  circuits, 286–288, 295  
   step response equations, 286, 296  
 Unilateral (one-sided) Laplace transform, 428–429  
 Unit impulse function  $\delta(t)$ , 431, 457  
 Unit step function  $u(t)$ , 429, 457, 652

## V

Vampire (standby) power, 359, 382–383  
 Variable-parameter function, 431–432  
 Volt-amp reactive (VAR), unit of, 363, 384  
 Volt-amps (VA), unit of, 368, 384  
 Voltage ( $v$ ), 11–13, 18, 26–29, 32–33, 38, 40–41, 48, 66–69, 76, 113–115, 146–150, 164, 176–179, 183–186, 188, 202–203, 221, 286–287, 306–308, 319, 338–340, 345, 398–405, 417, 466–469, 504  
   a-, b-, and c-phase, 398, 417  
   capacitors, 183–186, 202–203, 286–287, 467–468, 504  
   current ( $i$ ) and, 11–13, 177–179, 468–469  
   defined, 12, 18  
   determination of, 176–177  
   electric charge and, 11–12  
   equivalent capacitance in, 188  
   frequency domain, 319, 338–340, 345  
   gain ( $A$ ), 147  
   inductors, 176–179, 202, 466–467, 504  
   input constraints, 147–148, 164  
   Kirchhoff's law (KVL), 38–41, 48, 319, 402–403  
   line, 402–404  
   measurement of, 66–69, 76  
   natural response and, 221  
   negative (acb) phase sequence, 398  
   node-voltage equation ( $\mathbf{V}_N$ ), 400–401  
   operational amplifiers (op amps), 146–150, 164  
   phase, 398, 402–404  
   polarity of, 339–340  
   positive (abc) phase sequence, 398  
   power in a resistor, 32–33, 48  
    $RC$  circuits, deriving expression for, 221  
   reference direction, 13  
   resistors, 466, 504  
    $s$ -domain equations for, 466–469, 504  
   series  $RLC$  capacitor step response, 286–287  
   sinusoidal phase sequences, 398–399  
   sinusoidal source, 306–308, 345  
   sources, 26–29, 48, 399–400  
   terminal variable characteristics, 146–150, 164

Voltage ( $v$ ) (Continued)

- Thévenin equivalent ( $V_{Th}$ ), 113–115
  - three-phase, 398–405, 417
  - transfer characteristics of, 146–147, 164
  - transformer ratio, 338–340, 345
  - wye (Y) and delta ( $\Delta$ ) configurations, 399–400
  - wye-wye (Y-Y) circuit analysis and, 400–405, 417
- Voltage-divider circuits, 61–62, 75
- Voltage-division circuit analysis, 64–66, 75
- Voltage drop, 57, 64–65
- Voltage pulse analysis, 645, 666–668
- Voltage to current ( $v-i$ ) relationships, 176–177, 183, 315–318, 345
- capacitors, 183, 317–318
  - frequency domain, 315–318
  - impedance ( $Z$ ) of, 318
  - inductors, 176–177, 316–317
  - reactance of, 318
  - resistors, 315–316
  - sinusoidal steady-state analysis and, 315–316, 345
- Voltmeter, 66–67, 76

**W**

- Watt (W), unit of, 363, 384
- Wattmeter, 413–415, 417

## Waveforms, 602–604

- Weighting function, memory and, 492–493
- Wheatstone bridge, 69–70, 76
- Winding (primary and secondary), 333
- Wye (Y) connected loads, power in, 408–409
- Wye (Y) interconnection, 71
- Wye (Y) source configurations, 399–400
- Wye-delta (Y- $\Delta$ ) circuit analysis, 405–407
- Wye-wye (Y-Y) circuit analysis, 400–405, 417

**Z**

- $z$  parameters, two-port circuits, 679–680, 687–691
- Zero frequency, 528
- Zeros (roots), 452–453, 458, 484, 739–740, 747–749
  - Bode plots and, 739–740, 747–749
  - complex, 747–749
  - defined, 452
  - rational function  $F(s)$ , 452–453, 457
  - real, first order, 739–740
  - transfer function  $H(s)$ , 484

*This page intentionally left blank*

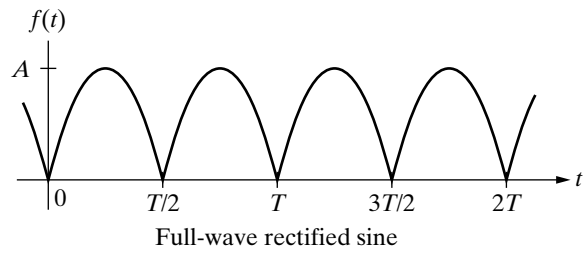
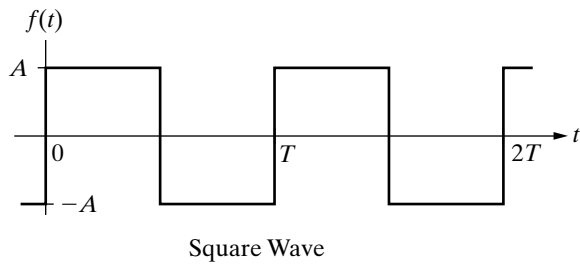
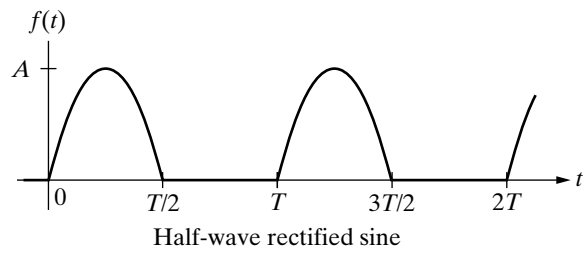
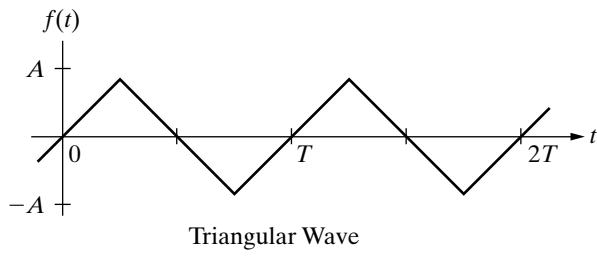
### An Abbreviated List of Laplace Transform Pairs

$f(t)$ ( $t > 0^-$ )	Type	$F(s)$
$\delta(t)$	(impulse)	1
$u(t)$	(step)	$\frac{1}{s}$
$t$	(ramp)	$\frac{1}{s^2}$
$e^{-at}$	(exponential)	$\frac{1}{s+a}$
$\sin \omega t$	(sine)	$\frac{\omega}{s^2 + \omega^2}$
$\cos \omega t$	(cosine)	$\frac{s}{s^2 + \omega^2}$
$te^{-at}$	(damped ramp)	$\frac{1}{(s+a)^2}$
$e^{-at} \sin \omega t$	(damped sine)	$\frac{\omega}{(s+a)^2 + \omega^2}$
$e^{-at} \cos \omega t$	(damped cosine)	$\frac{s+a}{(s+a)^2 + \omega^2}$

### An Abbreviated List of Operational Transforms

$f(t)$	$F(s)$
$Kf(t)$	$KF(s)$
$f_1(t) + f_2(t) - f_3(t) + \dots$	$F_1(s) + F_2(s) - F_3(s) + \dots$
$\frac{df(t)}{dt}$	$sF(s) - f(0^-)$
$\frac{d^2 f(t)}{dt^2}$	$s^2 F(s) - sf(0^-) - \frac{df(0^-)}{dt}$
$\frac{d^n f(t)}{dt^n}$	$s^n F(s) - s^{n-1} f(0^-) - s^{n-2} \frac{df(0^-)}{dt} - s^{n-3} \frac{d^2 f(0^-)}{dt^2} - \dots - \frac{d^{n-1} f(0^-)}{dt^{n-1}}$
$\int_0^t f(x) dx$	$\frac{F(s)}{s}$
$f(t-a)u(t-a), a > 0$	$e^{-as} F(s)$
$e^{-at} f(t)$	$F(s+a)$
$f(at), a > 0$	$\frac{1}{a} F\left(\frac{s}{a}\right)$
$tf(t)$	$-\frac{dF(s)}{ds}$
$t^n f(t)$	$(-1)^n \frac{d^n F(s)}{ds^n}$
$\frac{f(t)}{t}$	$\int_s^\infty F(u) du$

## Periodic Functions



## Fourier Series

$$f(t) = \frac{8A}{\pi^2} \sum_{n=1,3,5}^{\infty} \left[ \frac{1}{n^2} \sin\left(\frac{n\pi}{2}\right) \right] \sin n\omega_0 t$$

**Triangular wave**

$$f(t) = \frac{A}{\pi} + \frac{A}{2} \sin \omega_0 t - \frac{2A}{\pi} \sum_{n=2,4,6}^{\infty} \frac{\cos n\omega_0 t}{n^2 - 1}$$

**Half-wave rectified sine**

$$f(t) = \frac{4A}{\pi} \sum_{n=1,3,5}^{\infty} \frac{1}{n} \sin n\omega_0 t$$

**Square wave**

$$f(t) = \frac{2A}{\pi} - \frac{4A}{\pi} \sum_{n=1}^{\infty} \frac{\cos n\omega_0 t}{(4n^2 - 1)}$$

**Full-wave rectified sine**



### Fourier Transforms of Elementary Functions

$f(t)$	$F(\omega)$
$\delta(t)$ (impulse)	1
$A$ (constant)	$2\pi A\delta(\omega)$
$\text{sgn}(t)$ (signum)	$2/j\omega$
$u(t)$ (step)	$\pi\delta(\omega) + 1/j\omega$
$e^{-at}u(t)$ (positive-time exponential)	$1/(a + j\omega)$
$e^{at}u(-t)$ (negative-time exponential)	$1/(a - j\omega)$
$e^{-a t }$ (positive- and negative-time exponential)	$2a/(a^2 + \omega^2)$
$e^{j\omega_0 t}$ (complex exponential)	$2\pi\delta(\omega - \omega_0)$
$\cos \omega_0 t$ (cosine)	$\pi[\delta(\omega + \omega_0) + \delta(\omega - \omega_0)]$
$\sin \omega_0 t$ (sine)	$j\pi[\delta(\omega + \omega_0) - \delta(\omega - \omega_0)]$

### Operational Transforms

$f(t)$	$F(\omega)$
$Kf(t)$	$KF(\omega)$
$f_1(t) - f_2(t) + f_3(t)$	$F_1(\omega) - F_2(\omega) + F_3(\omega)$
$d^n f(t)/dt^n$	$(j\omega)^n F(\omega)$
$\int_{-\infty}^t f(x) dx$	$F(\omega)/j\omega$
$f(at)$	$\frac{1}{a} F\left(\frac{\omega}{a}\right), a > 0$
$f(t - a)$	$e^{-j\omega a} F(\omega)$
$e^{j\omega_0 t} f(t)$	$F(\omega - \omega_0)$
$f(t) \cos \omega_0 t$	$\frac{1}{2} F(\omega - \omega_0) + \frac{1}{2} F(\omega + \omega_0)$
$\int_{-\infty}^{\infty} x(\lambda)h(t - \lambda) d\lambda$	$X(\omega)H(\omega)$
$f_1(t)f_2(t)$	$\frac{1}{2\pi} \int_{-\infty}^{\infty} F_1(u)F_2(\omega - u) du$
$t^n f(t)$	$(j)^n \frac{d^n F(\omega)}{d\omega^n}$